

REVISIONS		
ZONE	REV	FINISHES:
		PB, AB, BZ & S
		GALUGE:
		22ga. .032

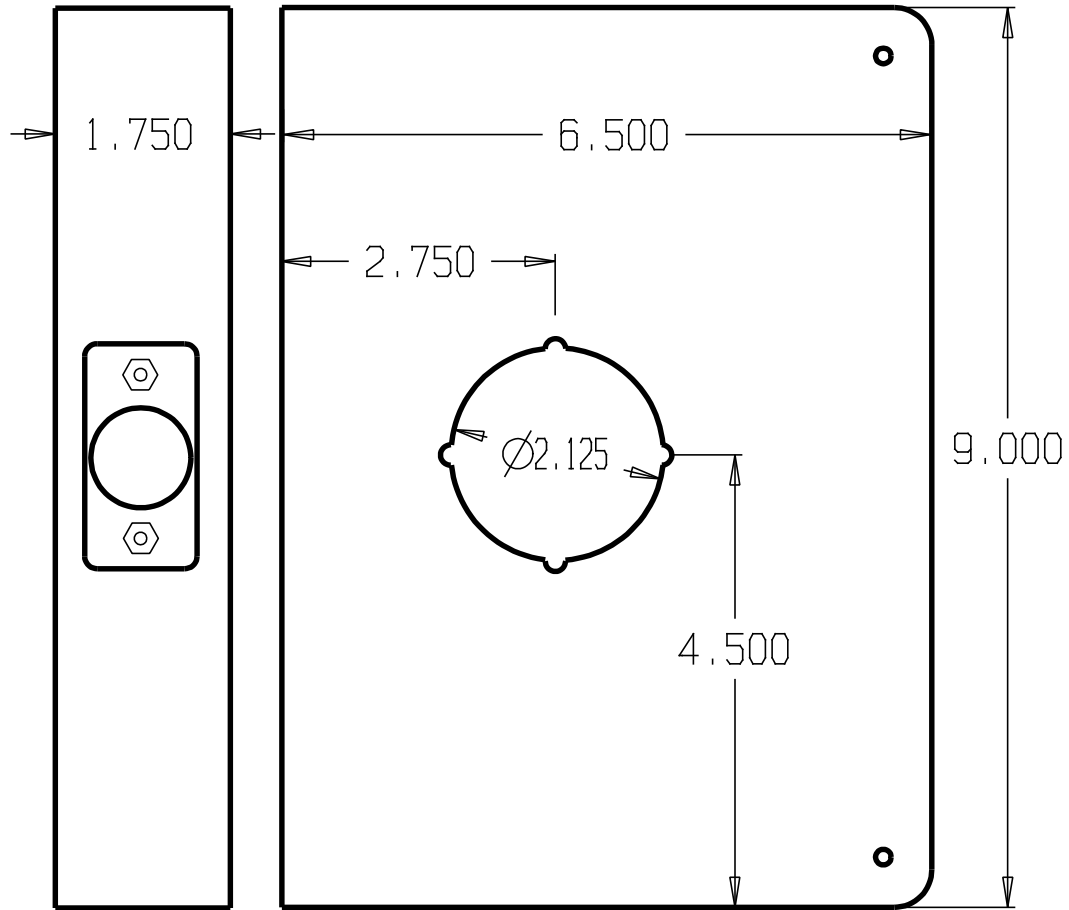

DON-JO MFG. INC.

DESIGNER	SIZE	DATE:	PART NO.	REV
	A	4/28/04	55A-CW	
APPROVED	SCALE	RELEASE DATE	WEIGHT	SHEET