

# Marina table

© design by Metrica

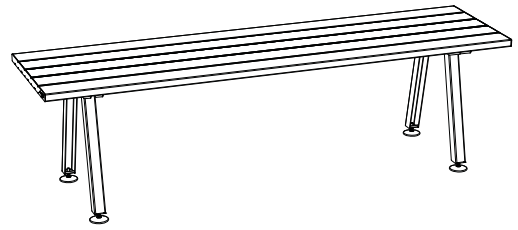
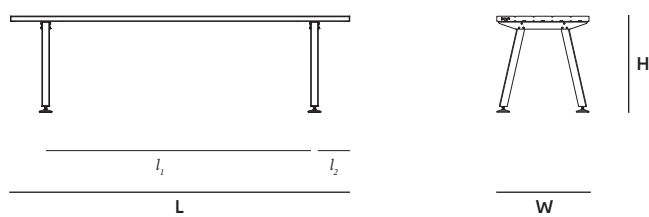

Table	2 legs
High table	3 legs
Extended tabletop	4 legs
Desk	5 legs
Bench	Floor fastening
Bistro	

## Marina table & high table



Dimensions (inch)	L	W <sub>(5 prof.)</sub>	W <sub>(6 prof.)</sub>	H	l <sub>1</sub>	l <sub>2</sub>	# legs
Marina table 0195	76,77	28,34	34,25	29,52	55,11	10,82	2
Marina table 0265	104,33	28,34	34,35	29,52	82,67	10,82	2
Marina table 0335	131,88	28,34	34,25	29,52	110,23	10,82	2
Marina table 0405	159,44	28,34	34,25	29,52	137,79	10,82	2

Dimensions (inch)	H
Marina high table	41,33

Marina high table comes in the same different lengths as the Marina tables.

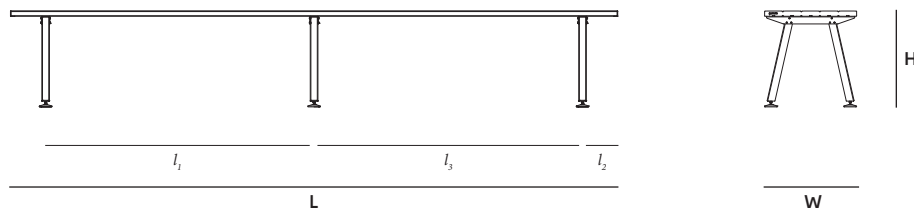

Dimensions (inch)	L	W <sub>(5 prof.)</sub>	W <sub>(6 prof.)</sub>	H	l <sub>1</sub>	l <sub>2</sub>	l <sub>3</sub>	# legs
Marina table 0475	187,00	28,34	34,25	29,52	82,67	10,82	82,67	3
Marina table 0545	214,56	28,34	34,25	29,52	110,23	10,82	82,67	3
Marina table 0615	242,12	28,34	34,25	29,52	110,23	10,82	110,23	3
Marina table 0685	269,68	28,34	34,25	29,52	137,79	10,82	110,23	3
Marina table 0755	297,24	28,34	34,25	29,52	137,79	10,82	137,79	3
Marina table 0825	324,80	28,34	34,25	29,52	110,23	10,82	82,67	4
Marina table 0895	352,36	28,34	34,25	29,52	110,23	10,82	110,23	4
Marina table 0965	379,92	28,34	34,25	29,52	110,23	10,82	137,79	4
Marina table 1035	407,48	28,34	34,25	29,52	137,79	10,82	110,23	4
Marina table 1105	435,03	28,34	34,25	29,52	137,79	10,82	137,79	4
Marina table 1175	462,59	28,34	34,25	29,52	110,23	10,82	110,23	5

**extremis®**

The content of this document, in particular the mentioned models, is protected by copyrights and/or design rights. The present document and its content is communicated to you for information purposes only. Any partial or total reproduction or any other use without our prior written permission is strictly prohibited. This technical sheet remains subject to possible changes. All dimensions are in inch, unless mentioned otherwise. Extremis is not responsible for the errors in the documentation of products. All measurements are approximate and are provided for informational purposes only.

**Tech sheet**  
20171002



BOX 1: 3 PROFILES



BOX 3: 1 SET FOR TABLE LEG



BOX 2: 2 PROFILES



BOX 4: ENDCAPS (+ REINFORCEMENT PROFILE)



Box dimensions (inch)		L	W	H	Qty (#)	Volume (ft³)	Gross weight (lb)	Net weight (lb)	Packaging weight (lb)
Marina table 195 (tabletop 720 mm)	Box 1	79,92	5,51	4,72	1	1,05	34,30	32,52	1,78
	Box 2	79,92	5,51	3,14	1	0,70	23,12	21,67	1,45
	Box 3	34,25	5,70	2,95	2	0,70	50,90	49,23	1,67
	Box 4	34,25	5,70	2,95	1	0,35	4,27	3,44	0,83
	<b>total:</b>				<b>2,80</b>	<b>2,80</b>	<b>112,59</b>	<b>106,86</b>	<b>5,73</b>
Marina table 195 (tabletop 870 mm)	Box 1	79,92	5,51	4,72	2	2,47	68,60	65,03	3,57
	Box 3	34,25	5,70	2,95	2	0,70	53,90	52,23	1,67
	Box 4	34,25	5,70	2,95	1	0,35	5,77	4,94	0,83
	<b>total:</b>				<b>3,52</b>	<b>3,52</b>	<b>128,27</b>	<b>122,20</b>	<b>6,07</b>
Marina table 265 (tabletop 720 mm)	Box 1	107,48	5,51	4,72	1	1,76	44,68	42,06	2,62
	Box 2	107,48	5,51	3,14	1	1,05	30,18	28,02	2,16
	Box 3	34,25	5,70	2,95	2	0,70	50,90	49,23	1,67
	Box 4	34,25	5,70	2,95	1	0,35	4,27	3,44	0,83
	<b>total:</b>				<b>3,86</b>	<b>3,86</b>	<b>130,03</b>	<b>122,75</b>	<b>7,28</b>
Marina table 265 (tabletop 870 mm)	Box 1	107,48	5,51	4,72	2	3,17	89,37	84,13	5,24
	Box 3	34,25	5,70	2,95	2	0,70	53,90	52,23	1,67
	Box 4	34,25	5,70	2,95	1	0,35	5,77	4,94	0,83
	<b>total:</b>				<b>4,22</b>	<b>4,22</b>	<b>149,04</b>	<b>141,30</b>	<b>7,74</b>
Marina table 335 (tabletop 720 mm)	Box 1	135,03	5,51	4,72	1	2,11	55,07	51,59	3,48
	Box 2	135,03	5,51	3,14	1	4,41	38,18	35,34	2,84
	Box 3	34,25	5,70	2,95	2	0,70	50,90	49,23	1,67
	Box 4	34,25	5,70	2,95	1	0,35	4,27	3,44	0,83
	<b>total:</b>				<b>7,57</b>	<b>7,57</b>	<b>148,42</b>	<b>139,60</b>	<b>8,82</b>
Marina table 335 (tabletop 870 mm)	Box 1	135,03	5,51	4,72	2	4,23	110,14	103,18	6,96
	Box 3	34,25	5,70	2,95	2	0,70	53,90	52,23	1,67
	Box 4	34,25	5,70	2,95	1	0,35	5,77	4,94	0,83
	<b>total:</b>				<b>5,28</b>	<b>5,28</b>	<b>169,81</b>	<b>160,35</b>	<b>9,46</b>
Marina table 405 (tabletop 720 mm)	Box 1	162,59	5,51	4,72	1	2,47	65,56	62,08	3,48
	Box 2	162,59	5,51	3,14	1	1,76	44,55	41,71	2,84
	Box 3	34,25	5,70	2,95	2	0,70	50,90	49,23	1,67
	Box 4	34,25	5,70	2,95	1	0,35	4,27	3,44	0,83
	<b>total:</b>				<b>5,28</b>	<b>5,28</b>	<b>165,28</b>	<b>156,47</b>	<b>8,81</b>
Marina table 405 (tabletop 870 mm)	Box 1	162,59	5,51	4,72	2	4,94	131,13	124,17	6,96
	Box 3	34,25	5,70	2,95	2	0,70	53,90	52,23	1,67
	Box 4	34,25	5,70	2,95	1	0,35	5,77	4,94	0,83
	<b>total:</b>				<b>5,99</b>	<b>5,99</b>	<b>190,80</b>	<b>181,34</b>	<b>9,46</b>

Box dimensions (inch)		L	W	H	Qty (#)	Volume (ft <sup>3</sup> )	Gross weight (lb)	Net weight (lb)	Packaging weight (lb)
Marina table 475 (tabletop 720 mm)	Box 1	190,15	5,51	4,72	1	2,82	76,32	72,00	4,32
	Box 2	190,15	5,51	3,14	1	1,76	51,08	47,56	3,52
	Box 3	34,25	5,70	2,95	3	1,05	76,39	73,86	2,53
	Box 4	34,25	5,70	2,95	1	0,35	4,27	3,44	0,83
					<b>total:</b>	<b>5,98</b>	<b>208,06</b>	<b>196,86</b>	<b>11,20</b>
Marina table 475 (tabletop 870 mm)	Box 1	190,15	5,51	4,72	2	5,65	152,62	143,98	8,64
	Box 3	34,25	5,70	2,95	3	1,05	80,88	78,35	2,53
	Box 4	34,25	5,70	2,95	1	0,35	5,77	4,94	0,83
					<b>total:</b>	<b>7,05</b>	<b>239,27</b>	<b>227,27</b>	<b>12,00</b>
Marina table 545 (tabletop 720 mm)	Box 1	217,71	5,51	4,72	1	3,17	86,75	81,60	5,15
	Box 2	217,71	5,51	3,14	1	2,11	58,13	53,90	4,23
	Box 3	34,25	5,70	2,95	3	1,05	76,39	73,86	2,53
	Box 4	34,25	5,70	2,95	1	0,35	4,27	3,44	0,83
					<b>total:</b>	<b>6,68</b>	<b>225,54</b>	<b>212,80</b>	<b>12,74</b>
Marina table 545 (tabletop 870 mm)	Box 1	217,71	5,51	4,72	2	6,70	173,50	163,19	10,31
	Box 3	34,25	5,70	2,95	3	1,05	80,88	78,35	2,53
	Box 4	34,25	5,70	2,95	1	0,35	5,77	4,94	0,83
					<b>total:</b>	<b>8,10</b>	<b>260,15</b>	<b>246,48</b>	<b>13,67</b>
Marina table 615 (tabletop 720 mm)	Box 1	245,27	5,51	4,72	1	3,53	97,24	92,09	5,15
	Box 2	245,27	5,51	3,14	1	2,47	66,40	62,17	4,23
	Box 3	34,25	5,70	2,95	3	1,05	76,39	73,86	2,53
	Box 4	34,25	5,70	2,95	1	0,35	4,27	3,44	0,83
					<b>total:</b>	<b>7,40</b>	<b>244,30</b>	<b>231,56</b>	<b>12,74</b>
Marina table 615 (tabletop 870 mm)	Box 1	245,27	5,51	4,72	2	7,41	194,49	184,18	10,31
	Box 3	34,25	5,70	2,95	3	1,05	80,88	78,35	2,53
	Box 4	34,25	5,70	2,95	1	0,35	5,77	4,94	0,83
					<b>total:</b>	<b>8,81</b>	<b>281,14</b>	<b>267,47</b>	<b>13,67</b>
Marina table 685 (tabletop 720 mm)	Box 1	272,83	5,51	4,72	1	4,23	107,62	101,61	6,01
	Box 2	272,83	5,51	3,14	1	2,82	73,43	68,52	4,91
	Box 3	34,25	5,70	2,95	3	1,05	76,39	73,86	2,53
	Box 4	34,25	5,70	2,95	1	0,35	4,27	3,44	0,83
					<b>total:</b>	<b>8,45</b>	<b>261,71</b>	<b>247,43</b>	<b>14,28</b>
Marina table 685 (tabletop 870 mm)	Box 1	272,83	5,51	4,72	2	8,12	215,25	203,22	12,03
	Box 3	34,25	5,70	2,95	3	1,05	80,88	78,35	2,53
	Box 4	34,25	5,70	2,95	1	0,35	5,77	4,94	0,83
					<b>total:</b>	<b>9,52</b>	<b>301,90</b>	<b>286,51</b>	<b>15,39</b>
Marina Table 755 (tabletop 720 mm)	Box 1	300,39	5,51	4,72	1	4,59	118,01	111,16	6,85
	Box 2	300,39	5,51	3,14	1	3,17	80,49	74,90	5,59
	Box 3	34,25	5,70	2,95	3	1,05	76,39	73,86	2,53
	Box 4	34,25	5,70	2,95	1	0,35	4,27	3,44	0,83
					<b>total:</b>	<b>9,16</b>	<b>279,16</b>	<b>263,36</b>	<b>15,80</b>
Marina table 755 (tabletop 870 mm)	Box 1	300,39	5,51	4,72	2	9,18	236,02	222,31	13,71
	Box 3	34,25	5,70	2,95	3	1,05	80,88	78,35	2,53
	Box 4	34,25	5,70	2,95	1	0,35	5,77	4,94	0,83
					<b>total:</b>	<b>10,58</b>	<b>322,67</b>	<b>305,60</b>	<b>17,07</b>

Box dimensions (inch)		L	W	H	Qty (#)	Volume (ft <sup>3</sup> )	Gross weight (lb)	Net weight (lb)	Packaging weight (lb)
Marina table 825 (tabletop 720 mm)	Box 1	327,95	5,51	4,72	1	4,94	124,75	118,10	6,65
	Box 2	327,95	5,51	3,14	1	3,17	89,46	84,02	5,44
	Box 3	34,25	5,70	2,95	4	1,41	101,83	98,46	3,37
	Box 4	34,25	5,70	2,95	1	0,35	10,40	9,57	0,83
					<b>total:</b>	<b>9,87</b>	<b>326,44</b>	<b>310,15</b>	<b>16,29</b>
Marina table 825 (tabletop 870 mm)	Box 1	327,95	5,51	4,72	2	9,88	249,49	236,18	13,31
	Box 3	34,25	5,70	2,95	4	1,41	107,82	104,45	3,37
	Box 4	34,25	5,70	2,95	1	0,35	13,97	13,14	0,83
					<b>total:</b>	<b>11,64</b>	<b>371,28</b>	<b>353,77</b>	<b>17,51</b>
Marina table 895 (tabletop 720 mm)	Box 1	355,51	5,51	4,72	1	5,29	139,31	131,62	7,69
	Box 2	355,51	5,51	3,14	1	3,53	95,28	88,98	6,30
	Box 3	34,25	5,70	2,95	4	1,41	101,83	98,46	3,37
	Box 4	34,25	5,70	2,95	1	0,35	10,40	9,57	0,83
					<b>total:</b>	<b>10,58</b>	<b>346,82</b>	<b>328,63</b>	<b>18,19</b>
Marina table 895 (tabletop 870 mm)	Box 1	355,51	5,51	4,72	2	10,59	278,62	263,24	15,38
	Box 3	34,25	5,70	2,95	4	1,41	107,82	104,45	3,37
	Box 4	34,25	5,70	2,95	1	0,35	13,97	13,14	0,83
					<b>total:</b>	<b>12,35</b>	<b>400,41</b>	<b>380,83</b>	<b>19,58</b>
Marina table 965 (tabletop 720 mm)	Box 1	383,07	5,51	4,72	1	5,65	149,69	141,14	8,55
	box 2	383,07	5,51	3,14	1	3,88	102,33	95,35	6,98
	Box 3	34,25	5,70	2,95	4	1,41	101,83	98,46	3,37
	Box 4	34,25	5,70	2,95	1	0,35	10,40	9,57	0,83
					<b>total:</b>	<b>11,29</b>	<b>364,25</b>	<b>344,52</b>	<b>19,73</b>
Marina table 965 (tabletop 870 mm)	Box 1	383,07	5,51	4,72	2	11,65	299,38	282,21	17,17
	Box 3	34,25	5,70	2,95	4	1,41	107,82	104,45	3,37
	Box 4	34,25	5,70	2,95	1	0,35	13,97	13,14	0,83
					<b>total:</b>	<b>13,41</b>	<b>458,79</b>	<b>437,42</b>	<b>21,37</b>
Marina table 1035 (tabletop 720 mm)	Box 1	410,62	5,51	4,72	1	6,35	159,23	150,68	8,55
	Box 2	410,62	5,51	3,14	1	4,23	108,68	101,70	6,98
	Box 3	34,25	5,70	2,95	4	1,41	101,83	98,46	3,37
	Box 4	34,25	5,70	2,95	1	0,35	10,40	9,57	0,83
					<b>total:</b>	<b>12,34</b>	<b>380,14</b>	<b>360,41</b>	<b>19,73</b>
Marina table 1035 (tabletop 870 mm)	Box 1	410,62	5,51	4,72	2	12,36	318,47	301,37	17,10
	Box 3	34,25	5,70	2,95	4	1,41	107,82	104,45	3,37
	Box 4	34,25	5,70	2,95	1	0,35	13,97	13,14	0,83
					<b>total:</b>	<b>14,12</b>	<b>440,26</b>	<b>418,96</b>	<b>21,30</b>
Marina table 1105 (tabletop 720 mm)	Box 1	438,18	5,51	4,72	1	6,70	169,62	160,23	9,39
	Box 2	438,18	5,51	3,14	1	4,23	115,74	108,07	7,67
	Box 3	34,25	5,70	2,95	4	1,41	101,83	98,46	3,37
	Box 4	34,25	5,70	2,95	1	0,35	10,40	9,57	0,83
					<b>total:</b>	<b>12,69</b>	<b>397,59</b>	<b>376,33</b>	<b>21,26</b>
Marina table 1105 (tabletop 870 mm)	Box 1	438,18	5,51	4,72	2	13,06	339,24	320,46	18,78
	Box 3	34,25	5,70	2,95	4	1,41	107,82	104,45	3,37
	Box 4	34,25	5,70	2,95	1	0,35	13,97	13,14	0,83
					<b>total:</b>	<b>14,82</b>	<b>461,03</b>	<b>438,05</b>	<b>22,98</b>

Box dimensions (inch)		L	W	H	Qty (#)	Volume (ft <sup>3</sup> )	Gross weight (lb)	Net weight (lb)	Packaging weight (lb)
Marina table 1175 (tabletop 720 mm)	Box 1	465,74	5,51	4,72	1	7,06	169,62	160,23	9,39
	Box 2	465,74	5,51	3,14	1	4,59	115,74	108,07	7,67
	Box 3	34,25	5,70	2,95	5	1,76	127,29	123,08	4,21
	Box 4	34,25	5,70	2,95	1	0,35	16,53	15,70	0,83
	<b>total:</b>				<b>13,76</b>		<b>429,18</b>	<b>407,08</b>	<b>22,10</b>
Marina table 1175 (tabletop 870 mm)	Box 1	465,74	5,51	4,72	2	14,12	361,09	342,31	18,78
	Box 3	34,25	5,70	2,95	5	1,76	134,79	130,58	4,21
	Box 4	34,25	5,70	2,95	1	0,35	22,17	21,34	0,83
	<b>total:</b>				<b>16,23</b>		<b>518,05</b>	<b>494,23</b>	<b>23,82</b>

### Extended tabletop

Dimensions (inch)	$l_1$	$l_2$
Extended tabletop (1 side)	29,52	/
Extended tabletop (2 side)	29,52	29,52

Extended tabletop (1 side): On one side, an extra 21,65 inch is added to the Marina table.  
 Extended tabletop (2 sides): On both sides, an extra 21,65 inch is added to the Marina table (1100 mm in total).

### Desk

Dimensions (inch)	W	H	$w_1$
Marina desk standard gap	56,45	29,52	0,19
Marina desk small gap	57,67	29,52	0,98
Marina desk wide gap	58,66	29,52	1,96

## Bench

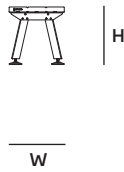
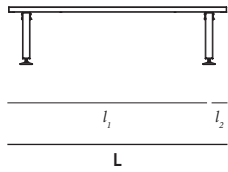

Dimensions (inch)	L	W	H	$l_1$	$l_2$
Marina bench 110	43,30	16,92	17,71	32,48	5,41
Marina bench 170	66,92	16,92	17,71	56,10	5,41

BOX 1: PROFILES



BOX 2: 1 SET FOR TABLE LEG + END PIECES



Box dimensions (inch)		L	W	H	Qty (#)	Volume (ft <sup>3</sup> )	Gross weight (lb)	Net weight (lb)	Packaging weight (lb)
Marina bench 110	Box 1	46,45	5,51	4,72	1	0,70	22,72	20,94	1,78
	Box 2	34,25	5,70	2,95	1	0,35	32,45	31,40	1,05
					<b>total:</b>	<b>1,05</b>	<b>55,17</b>	<b>52,34</b>	<b>2,83</b>
Marina bench 170	Box 1	70,07	5,51	4,72	1	1,05	30,90	29,12	1,78
	Box 2	34,25	5,70	2,95	1	0,35	32,45	31,40	1,05
					<b>total:</b>	<b>1,40</b>	<b>63,35</b>	<b>60,52</b>	<b>2,83</b>

## Bistro

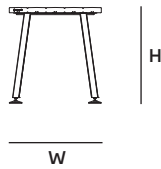
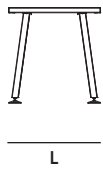

Dimensions (inch)	L	W	H
Marina bistro 72	28,34	28,34	29,52
Marina bistro 144	56,69	28,38	29,52

BOX 1: 3 PROFILES



BOX 2: 2 PROFILES



BOX 3: TABLE LEGS + END PIECES



Box dimensions (inch)		L	W	H	Qty (#)	Volume (ft <sup>3</sup> )	Gross weight (lb)	Net weight (lb)	Packaging weight (lb)
Marina bistro 72	Box 1	31,49	5,51	4,72	1	0,35	13,66	12,72	0,94
	Box 2	31,49	5,51	3,14	1	0,35	8,37	7,60	0,77
	Box 3	27,55	27,55	5,70	1	2,47	26,85	25,53	1,32
					<b>total:</b>	<b>3,17</b>	<b>48,88</b>	<b>45,85</b>	<b>3,03</b>
Marina bistro 144	Box 1	59,84	5,51	4,72	1	1,05	27,33	25,68	1,65
	Box 2	59,84	5,51	3,14	1	0,70	16,75	15,43	1,32
	Box 3	27,55	27,55	5,70	1	2,47	26,85	25,53	1,32
					<b>total:</b>	<b>4,22</b>	<b>70,93</b>	<b>66,64</b>	<b>4,29</b>

## Materials & colours



Materials	Key facts	Thickness	Layer thickness	Density	In/outdoor	Water	UV colour fastness	Flame retarding
		inch	micron					
Fibre glass tabletop	<ul style="list-style-type: none"> <li>Made with pultrusion technique: a non-stop process of fibre glass wires pulled through a bath of polyester</li> <li>Strong</li> <li>Lightweight</li> </ul>	0,10	n.a.	0,11 10 <sup>3</sup> lb/ft <sup>3</sup>	Outdoor & indoor	n.a.	The white hue can change to some extent when exposed to UV	/
Powder-coated electro galvanised steel legs	<ul style="list-style-type: none"> <li>Easy to clean</li> <li>Electro galvanised (for extra protection against rust), then powder-coated</li> </ul>	0,11	100	0,47 10 <sup>3</sup> lb/ft <sup>3</sup>	Outdoor & indoor	n.a.	Very good: the white hue can change to some extent when exposed to UV	NEN-EN13501-1 A1 *
Polyamide feet	<ul style="list-style-type: none"> <li>Injection-moulded nylon</li> <li>Adjustable in height and surface</li> </ul>	n.a.	n.a.	0,07 10 <sup>3</sup> lb/ft <sup>3</sup>	Outdoor & indoor	n.a.	Very good	/

\* NEN-EN13501-1 A1

Class A1 products will not contribute to fire in any stage, including fully developed fire. For this reason, they are assumed to be capable of satisfying all requirements of all lower classes as well.

WE STRONGLY ADVISE AGAINST USING POWER TOOLS GIVEN THE RISK OF THREAD GALLING ON THE STAINLESS STEEL BOLTS.

FOR TABLES WITH 3 LEGS OR MORE, WE RECOMMEND USING TRESTLES TO ATTACH THE TABLE LEG ASSEMBLIES TO THE TABLETOP, INSTEAD OF KEEPING IT UPSIDE DOWN.

WE STRONGLY ADVISE YOU AGAINST STANDING ON TOP OF THE TABLE! A CONCENTRATED LOAD CAN CAUSE SMALL PERCEPTIBLE CRACKS IN THE PROFILES THAT MIGHT BE VISUALLY ANNOYING, ALTHOUGH THEY DO NOT AFFECT THE STRENGTH OF THE TABLE IN ANY WAY.

STAINS SHOULD BE REMOVED IMMEDIATELY WITH A CLEAN, SOFT CLOTH, PARTICULARLY IN CASE OF DARK-COLOURED LIQUIDS SUCH AS WINE, INK, COFFEE, COKE, OIL OR BIRD DROPPINGS. IF LEFT TO DRY, THESE LIQUIDS MAY CAUSE PERMANENT DAMAGE!



## Applications

**Residential:** on terraces, patios, courtyards. Indoor or outdoor, as a dining table, desk, ...

**Project:** hotel and catering industry, company terraces, public spaces, offices, meeting rooms, bars, ...

Marina table combines perfectly with Captain's Chairs & Marina benches.



## Floor fastening

Marina table comes with an optional floor fastening set.

Find more instructions in the manual.



## Assembly

- Do not use power tools to assemble your Marina table.
- Only to be mounted with no. 10 - 17 spanner and no. 3 - 4 hex key.

## F.a.q.

**Q: What is the biggest size possible?**

**A:** We even produced a 1181,10 inch table, the only problem is transport. We can deliver tables up to 275,59 inch without extra costs.

**Q: What about UV-resistance?**

**A:** By adding special additives, the material of the Marina picnic has a much higher UV-resistance than other white synthetics. It goes without saying that white will not stay brilliantly white.

**Q: Are the legs corrosion-resistant?**

**A:** Legs are first galvanised, and powder-coated afterwards. This way, we have a double protection layer.

## Good to know

- 27,55 inch / person.
- Additional transport costs are applicable for products that exceed 275,59 inch.
- Fibre glass reinforced polyester resin material is made with the so-called pultrusion technique. Pultrusion is a non-stop process of pulling fibre glass wires through a bath of polyester resin and letting them harder in a matrix afterwards to get their final shape.
- Main advantages of this material are its strength and low weight.

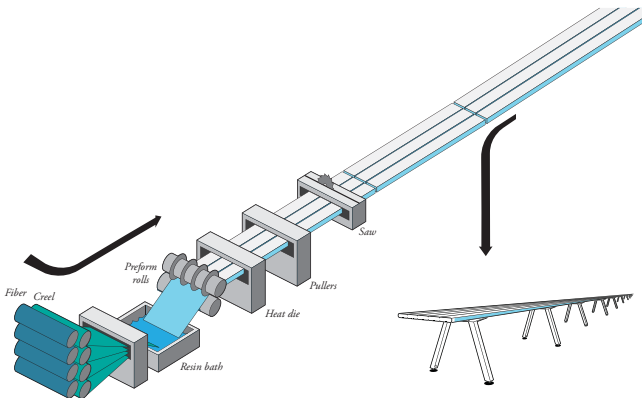

## Maintenance

Find maintenance instructions at the downloads section of [extremis.com](http://extremis.com) for:

### FIBRE GLASS PROFILES

- Stains should be removed immediately with a clean, soft cloth, particularly in case of dark-coloured liquids such as wine, ink, coffee, coke, oil and bird droppings. If left to dry, these liquids may cause permanent damage!
- Use common kitchen cleaning products. Avoid using aggressive products. These surfaces are best cleaned with a neutral cleaning product diluted in water.
- In case of stubborn stains, we recommend using a magic sponge.
- Stubborn stains can also be removed using acetone.

### POWDER-COATED PARTS

- White powder-coating requires more maintenance obviously
- Cleaning stains with a magic eraser

## Website

[www.extremis.com/marinatable](http://www.extremis.com/marinatable)

## Awards

