

Marina combo

© design by Metrica

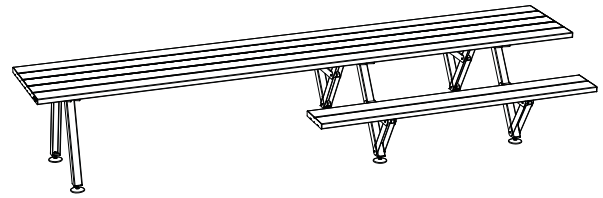

- 3 legs
- 4 legs
- 5 legs
- Floor fastening

Marina combo

| | | | | | | | | | | | | | | |
|--------------------------|----------|------------------------------|------------------------------|----------|----------------------|----------------------|----------------------|----------------------|--------------------------------|--------------------------------|--------------------------------|--------------------------------|----------------------|----------------------|
| | | | | | | | | | | | | | | |
| Dimensions (inch) | L | W_(5 prof.) | W_(6 prof.) | H | <i>l₁</i> | <i>l₂</i> | <i>l₃</i> | <i>l₄</i> | <i>l₅</i> | <i>l₆</i> | <i>w_{1 (5 prof.)}</i> | <i>w_{1 (6 prof.)}</i> | <i>w₂</i> | <i>h₁</i> |
| Marina combo 360 | 141,73 | 60,62 | 66,92 | 29,52 | 64,96 | 76,77 | 10,82 | 43,30 | 65,94 | 10,82 | 28,34 | 34,25 | 11,22 | 17,71 |
| Marina combo 415 | 163,38 | 60,62 | 66,92 | 29,52 | 86,61 | 76,77 | 21,65 | 43,30 | 65,94 | 10,82 | 28,34 | 34,25 | 11,22 | 17,71 |
| Marina combo 470 | 185,03 | 60,62 | 66,92 | 29,52 | 108,26 | 76,77 | 21,65 | 64,96 | 65,94 | 10,82 | 28,34 | 34,25 | 11,22 | 17,71 |
| Marina combo 485 | 190,94 | 60,62 | 66,92 | 29,52 | 86,61 | 104,33 | 21,65 | 43,30 | 93,50 | 10,82 | 28,34 | 34,25 | 11,22 | 17,71 |
| Marina combo 595 | 234,25 | 60,62 | 66,92 | 29,52 | 129,92 | 104,33 | 21,65 | 86,61 | 93,50 | 10,82 | 28,34 | 34,25 | 11,22 | 17,71 |
| | | | | | | | | | | | | | | |
| Dimensions (inch) | L | W_(5 prof.) | W_(6 prof.) | H | <i>l₁</i> | <i>l₂</i> | <i>l₃</i> | <i>l₄</i> | <i>w_{1 (5 prof.)}</i> | <i>w_{1 (6 prof.)}</i> | <i>w₂</i> | <i>h₁</i> | | |
| Marina combo 595 | 234,25 | 60,62 | 66,92 | 29,52 | 64,96 | 104,33 | 10,82 | 43,30 | 28,34 | 34,25 | 11,22 | 17,71 | | |
| | | | | | | | | | | | | | | |
| Dimensions (inch) | L | W_(5 prof.) | W_(6 prof.) | H | <i>l₁</i> | <i>l₂</i> | <i>l₃</i> | <i>l₄</i> | <i>l₅</i> | <i>w_{1 (5 prof.)}</i> | <i>w_{1 (6 prof.)}</i> | <i>w₂</i> | <i>h₁</i> | |
| Marina combo 665 | 261,81 | 60,62 | 66,92 | 29,52 | 64,96 | 131,88 | 10,82 | 43,30 | 65,94 | 28,34 | 34,25 | 11,22 | 17,71 | |
| Marina combo 775 | 305,11 | 60,62 | 66,92 | 29,52 | 86,61 | 131,88 | 21,65 | 43,30 | 65,94 | 28,34 | 34,25 | 11,22 | 17,71 | |
| Marina combo 1205 | 474,40 | 60,62 | 66,92 | 29,52 | 129,92 | 214,56 | 21,65 | 86,61 | 108,26 | 28,34 | 34,25 | 11,22 | 17,71 | |

extremis®

The content of this document, in particular the mentioned models, is protected by copyrights and/or design rights. The present document and its content is communicated to you for information purposes only. Any partial or total reproduction or any other use without our prior written permission is strictly prohibited. This technical sheet remains subject to possible changes. **All dimensions are in inch**, unless mentioned otherwise. Extremis is not responsible for the errors in the documentation of products. All measurements are approximate and are provided for informational purposes only.

**Tech
sheet**
20170929



BOX 1: 3 PROFILES FOR TABLETOP



BOX 2: 2 PROFILES FOR TABLETOP



BOX 3: 2 PROFILES FOR BENCHES



BOX 4: 1 SET PICNIC LEGS



BOX 5: 1 SET TABLE LEGS



BOX 6: ENDCAPS (+ REINFORCEMENT PROFILES)



| Box dimensions (inch) | | L | W | H | Qty (#) | Volume (ft ³) | Gross weight (lb) | Net weight (lb) | Packaging weight (lb) |
|------------------------------------|---------------|--------|------|------|---------|---------------------------|-------------------|-----------------|-----------------------|
| Marina combo 360 (tabletop 720 mm) | Box 1 | 144,88 | 5,51 | 4,72 | 1 | 2,11 | 59,81 | 56,33 | 3,48 |
| | Box 2 | 144,88 | 5,51 | 3,14 | 1 | 1,41 | 40,38 | 37,54 | 2,84 |
| | Box 3 | 68,11 | 5,51 | 3,14 | 2 | 1,41 | 39,85 | 37,47 | 2,38 |
| | Box 4 | 34,25 | 8,58 | 2,95 | 2 | 1,05 | 80,60 | 78,51 | 2,09 |
| | Box 5 | 34,25 | 5,70 | 2,95 | 1 | 0,35 | 25,46 | 24,63 | 0,83 |
| | Box 6 | 34,25 | 5,70 | 2,95 | 1 | 0,35 | 6,92 | 6,09 | 0,83 |
| | total: | | | | | 6,68 | 6,68 | 253,02 | 240,57 |
| Marina combo 360 (tabletop 870 mm) | Box 1 | 144,88 | 5,51 | 4,72 | 2 | 4,23 | 119,60 | 112,66 | 6,94 |
| | Box 3 | 144,88 | 5,51 | 3,14 | 2 | 1,41 | 40,30 | 37,92 | 2,38 |
| | Box 4 | 34,25 | 8,58 | 2,95 | 2 | 1,05 | 83,59 | 81,50 | 2,09 |
| | Box 5 | 34,25 | 5,70 | 2,95 | 1 | 0,35 | 26,96 | 26,13 | 0,83 |
| | Box 6 | 34,25 | 5,70 | 2,95 | 1 | 0,35 | 8,42 | 7,59 | 0,83 |
| | total: | | | | | 7,39 | 7,39 | 278,87 | 265,80 |
| Marina combo 415 (tabletop 720 mm) | Box 1 | 166,53 | 5,51 | 4,72 | 1 | 2,47 | 69,15 | 65,67 | 3,48 |
| | Box 2 | 166,53 | 5,51 | 3,14 | 1 | 1,76 | 46,62 | 43,78 | 2,84 |
| | Box 3 | 89,76 | 5,51 | 3,14 | 2 | 1,76 | 55,93 | 52,85 | 3,08 |
| | Box 4 | 34,25 | 8,58 | 2,95 | 2 | 1,05 | 80,60 | 78,51 | 2,09 |
| | Box 5 | 34,25 | 5,70 | 2,95 | 1 | 0,35 | 25,46 | 24,63 | 0,83 |
| | Box 6 | 34,25 | 5,70 | 2,95 | 1 | 0,35 | 6,92 | 6,09 | 0,83 |
| | total: | | | | | 7,74 | 7,74 | 284,69 | 271,53 |
| Marina combo 415 (tabletop 870 mm) | Box 1 | 166,53 | 5,51 | 4,72 | 2 | 4,94 | 138,27 | 131,33 | 6,94 |
| | Box 3 | 89,76 | 5,51 | 3,14 | 2 | 1,76 | 55,93 | 52,85 | 3,08 |
| | Box 4 | 34,25 | 5,58 | 2,95 | 2 | 1,05 | 83,59 | 81,50 | 2,09 |
| | Box 5 | 34,25 | 5,70 | 2,95 | 1 | 0,35 | 26,96 | 26,13 | 0,83 |
| | Box 6 | 34,25 | 5,70 | 2,95 | 1 | 0,35 | 8,42 | 7,59 | 0,83 |
| | total: | | | | | 8,45 | 8,45 | 313,17 | 299,40 |

| Box dimensions (mm) | | L | W | H | Qty (#) | Volume (m ³) | Gross weight (kg) | Net weight (kg) | Packaging weight (kg) |
|------------------------------------|-------|--------|------|------|---------------|--------------------------|-------------------|-----------------|-----------------------|
| Marina combo 470 (tabletop 720 mm) | Box 1 | 188,18 | 5,51 | 4,72 | 1 | 2,82 | 77,49 | 73,17 | 4,32 |
| | Box 2 | 188,18 | 5,51 | 3,14 | 1 | 1,76 | 52,29 | 48,77 | 3,52 |
| | Box 3 | 111,41 | 5,51 | 3,14 | 2 | 2,11 | 66,57 | 62,83 | 3,74 |
| | Box 4 | 34,25 | 8,58 | 2,95 | 2 | 1,05 | 80,60 | 78,51 | 2,09 |
| | Box 5 | 34,25 | 5,70 | 2,95 | 1 | 0,35 | 25,46 | 24,63 | 0,83 |
| | Box 6 | 34,25 | 5,70 | 2,95 | 1 | 0,35 | 6,94 | 6,11 | 0,83 |
| | | | | | total: | 8,44 | 309,35 | 294,02 | 15,33 |
| Marina combo 470 (tabletop 870 mm) | Box 1 | 188,18 | 5,51 | 4,72 | 2 | 5,65 | 154,96 | 146,32 | 8,64 |
| | Box 3 | 111,41 | 5,51 | 3,14 | 2 | 2,11 | 66,57 | 62,83 | 3,74 |
| | Box 4 | 34,25 | 8,58 | 2,95 | 2 | 1,05 | 83,59 | 81,50 | 2,09 |
| | Box 5 | 34,25 | 5,70 | 2,95 | 1 | 0,35 | 26,96 | 26,13 | 0,83 |
| | Box 6 | 34,25 | 5,70 | 2,95 | 1 | 0,35 | 8,42 | 7,59 | 0,83 |
| | | | | | total: | 9,51 | 340,50 | 324,37 | 16,13 |
| Marina combo 485 (tabletop 720 mm) | Box 1 | 194,09 | 5,51 | 4,72 | 1 | 2,82 | 82,36 | 78,04 | 4,32 |
| | Box 2 | 194,09 | 5,51 | 3,14 | 1 | 1,76 | 55,55 | 52,03 | 3,52 |
| | Box 3 | 89,76 | 5,51 | 3,14 | 2 | 1,76 | 55,93 | 52,85 | 3,08 |
| | Box 4 | 34,25 | 8,58 | 2,95 | 2 | 1,05 | 80,60 | 78,51 | 2,09 |
| | Box 5 | 34,25 | 5,70 | 2,95 | 1 | 0,35 | 25,46 | 24,63 | 0,83 |
| | Box 6 | 34,25 | 5,70 | 2,95 | 1 | 0,35 | 6,94 | 6,11 | 0,83 |
| | | | | | total: | 8,09 | 306,84 | 292,17 | 14,67 |
| Marina combo 485 (tabletop 870 mm) | Box 1 | 194,09 | 5,51 | 4,72 | 2 | 6,00 | 164,75 | 156,11 | 8,64 |
| | Box 3 | 89,76 | 5,51 | 3,14 | 2 | 1,76 | 55,93 | 52,85 | 3,08 |
| | Box 4 | 34,25 | 8,58 | 2,95 | 2 | 1,05 | 83,59 | 81,50 | 2,09 |
| | Box 5 | 34,25 | 5,70 | 2,95 | 1 | 0,35 | 26,96 | 26,13 | 0,83 |
| | Box 6 | 34,25 | 5,70 | 2,95 | 1 | 0,35 | 8,42 | 7,59 | 0,83 |
| | | | | | total: | 9,51 | 339,65 | 324,18 | 15,47 |
| Marina combo 595 (tabletop 720 mm) | Box 1 | 237,40 | 5,51 | 4,72 | 1 | 3,53 | 95,34 | 90,19 | 5,15 |
| | Box 2 | 237,40 | 5,51 | 3,14 | 1 | 2,47 | 64,35 | 60,12 | 4,23 |
| | Box 3 | 133,07 | 5,51 | 3,14 | 2 | 2,82 | 77,29 | 72,82 | 4,47 |
| | Box 4 | 34,25 | 8,58 | 2,95 | 2 | 1,05 | 80,60 | 78,51 | 2,09 |
| | Box 5 | 34,25 | 5,70 | 2,95 | 1 | 0,35 | 25,46 | 24,63 | 0,83 |
| | Box 6 | 34,25 | 5,70 | 2,95 | 1 | 0,35 | 6,94 | 6,11 | 0,83 |
| | | | | | total: | 10,57 | 349,98 | 332,38 | 17,60 |
| Marina combo 595 (tabletop 870 mm) | Box 1 | 237,40 | 5,51 | 4,72 | 2 | 7,06 | 190,72 | 180,39 | 10,33 |
| | Box 3 | 133,07 | 5,51 | 3,14 | 2 | 2,82 | 77,29 | 72,82 | 4,47 |
| | Box 4 | 34,25 | 8,58 | 2,95 | 2 | 1,05 | 83,59 | 81,50 | 2,09 |
| | Box 5 | 34,25 | 5,70 | 2,95 | 1 | 0,35 | 26,96 | 26,13 | 0,83 |
| | Box 6 | 34,25 | 5,70 | 2,95 | 1 | 0,35 | 8,42 | 7,59 | 0,83 |
| | | | | | total: | 11,63 | 386,98 | 368,43 | 18,55 |

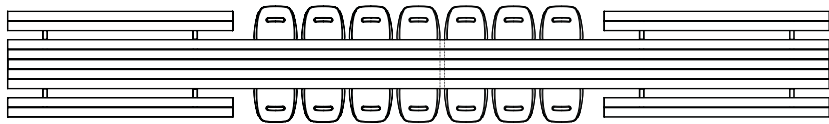
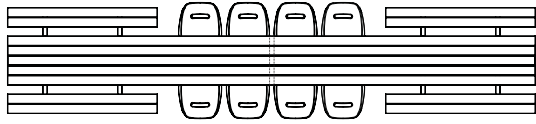
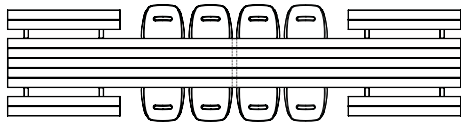
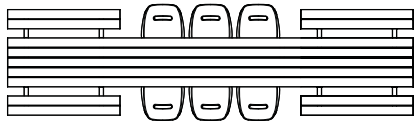
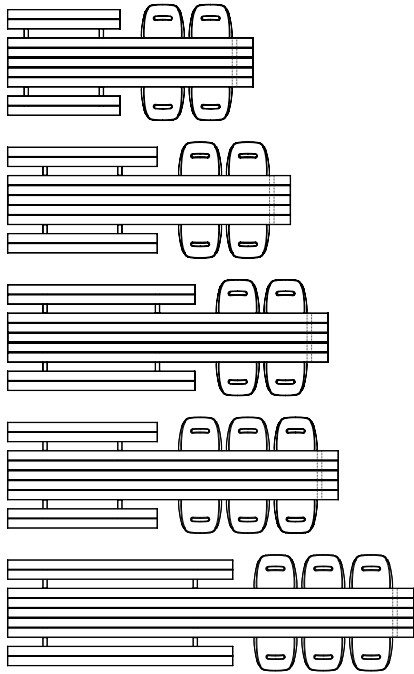

Materials & colours

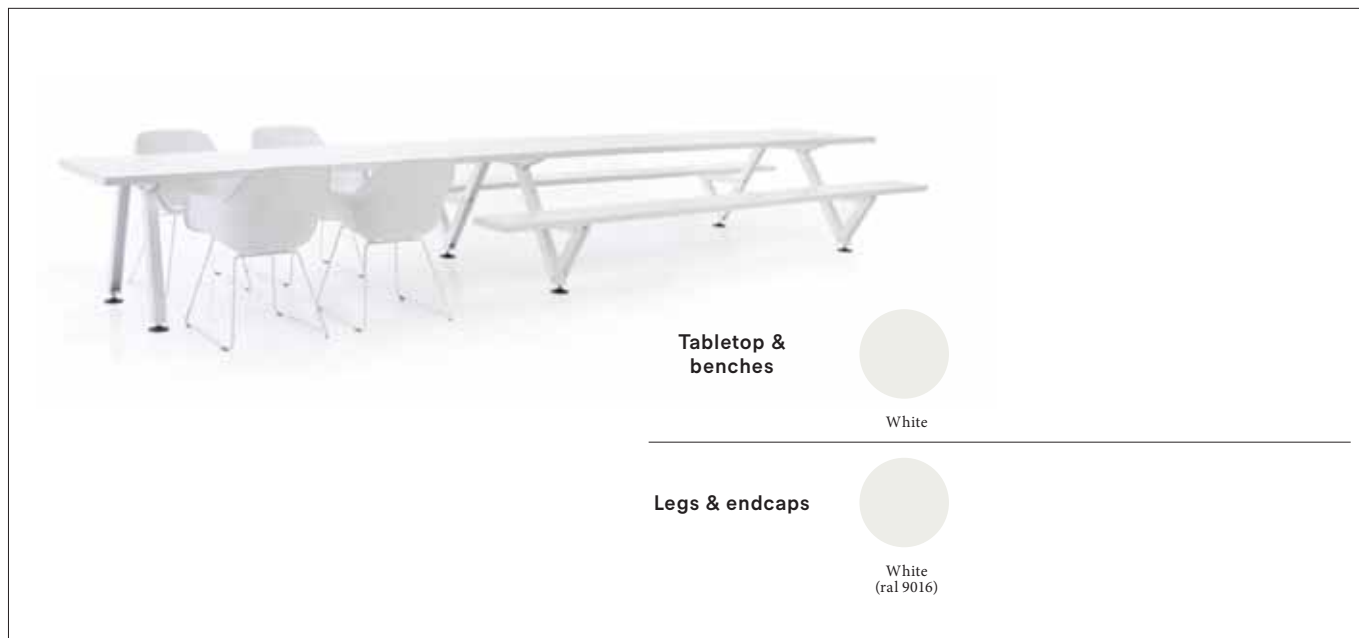

| Materials | Key facts | Thickness | Layer thickness | Density | In/outdoor | Water | UV colour fastness | Flame retarding |
|---------------------------------------------|---------------------------------------------------------------------------------------------------------------------------------------------------------------------------------------------------|-----------|-----------------|-----------------------------------------|------------------|-------|-----------------------------------------------------------------------|--------------------|
| | | inch | micron | | | | | |
| Fibre glass tabletop & benches | <ul style="list-style-type: none"> Made with pultrusion technique: a non-stop process of fibre glass wires pulled through a bath of polyester Strong Lightweight | 0,10 | n.a. | 0,11 10 ³ lb/ft ³ | Outdoor & indoor | n.a. | The white hue can change to some extent when exposed to UV | / |
| Powder-coated electro galvanised steel legs | <ul style="list-style-type: none"> Easy to clean Electro galvanised (for extra protection against rust), then powder-coated | 0,11 | 100 | 0,47 10 ³ lb/ft ³ | Outdoor & indoor | n.a. | Very good: the white hue can change to some extent when exposed to UV | NEN-EN13501-1 A1 * |
| Polyamide feet | <ul style="list-style-type: none"> Injection-moulded nylon Adjustable in height and surface | n.a. | n.a. | 0,07 10 ³ lb/ft ³ | Outdoor & indoor | n.a. | Very good | / |

* NEN-EN13501-1 A1

Class A1 products will not contribute to fire in any stage, including fully developed fire. For this reason, they are assumed to be capable of satisfying all requirements of all lower classes as well.

WE STRONGLY ADVISE AGAINST USING POWER TOOLS GIVEN THE RISK OF THREAD GALLING ON THE STAINLESS STEEL BOLTS.

FOR TABLES WITH 3 LEGS OR MORE, WE RECOMMEND USING TRESTLES TO ATTACH THE TABLE LEG ASSEMBLIES TO THE TABLETOP, INSTEAD OF KEEPING IT UPSIDE DOWN.

WE STRONGLY ADVISE YOU AGAINST STANDING ON TOP OF THE TABLE! A CONCENTRATED LOAD CAN CAUSE SMALL PERCEPTIBLE CRACKS IN THE PROFILES THAT MIGHT BE VISUALLY ANNOYING, ALTHOUGH THEY DO NOT AFFECT THE STRENGTH OF THE TABLE IN ANY WAY.

STAINS SHOULD BE REMOVED IMMEDIATELY WITH A CLEAN, SOFT CLOTH, PARTICULARLY IN CASE OF DARK-COLOURED LIQUIDS SUCH AS WINE, INK, COFFEE, COKE, OIL OR BIRD DROPPINGS. IF LEFT TO DRY, THESE LIQUIDS MAY CAUSE PERMANENT DAMAGE!



Applications

Residential: on terraces, patios, courtyards, shared gardens. Indoor or outdoor, as a dining table, ...

Project: hotel and catering industry, company terraces, public spaces, offices, meeting rooms, bars, ...

Good to know

- 55 cm bench space / person.
- Additional transport costs are applicable for products that exceed 7m.
- The average transport volume is 6,00 ft³ / person, which is really low.
- Fibre glass reinforced polyester resin material is made with the so-called pultrusion technique. Pultrusion is a non-stop process of pulling fibre glass wires through a bath of polyester resin and letting them harder in a matrix afterwards to get their final shape.
- Main advantages of this material are its strength and low weight.

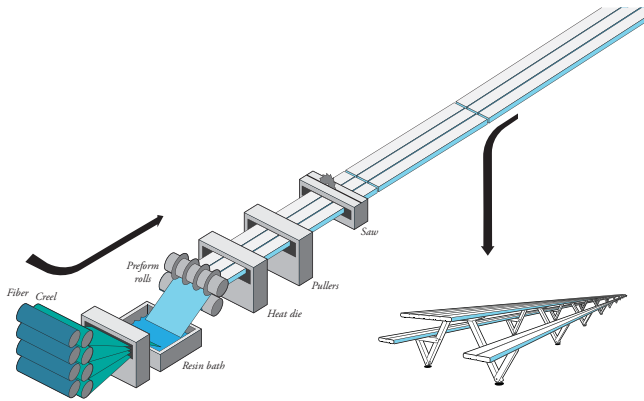

Awards



Floor fastening

Marina combo comes with an optional floor fastening set.

Find more instructions in the manual.



Assembly

- Do not use power tools to assemble your Marina combo.
- Only to be mounted with no. 10 - 17 spanner and no. 3 - 4 hex key.

F.a.q.

Q: What is the biggest size possible?

A: We even produced a 30m table, the only problem is transport. We can deliver tables up to 7m without extra costs.

Q: What about UV-resistance?

A: By adding special additives, the material of the Marina picnic has a much higher UV-resistance than other white synthetics. It goes without saying that white will not stay brilliantly white.

Q: Are the legs corrosion-resistant?

A: Legs are first galvanised, and powder-coated afterwards. This way, we have a double protection layer.

Q: Can we make different combinations?

A: The combinations on the previous pages are only suggestions. The only limit is your own imagination.

Maintenance

Find maintenance instructions at the downloads section of extremis.com for:

FIBRE GLASS PROFILES

- Stains should be removed immediately with a clean, soft cloth, particularly in case of dark-coloured liquids such as wine, ink, coffee, coke, oil and bird droppings. If left to dry, these liquids may cause permanent damage!
- Use common kitchen cleaning products. Avoid using aggressive products. These surfaces are best cleaned with a neutral cleaning product diluted in water.
- In case of stubborn stains, we recommend using a magic sponge.
- Stubborn stains can also be removed using acetone.

POWDER-COATED PARTS

- White powder-coating requires more maintenance obviously
- Cleaning stains with a magic eraser

Website

www.extremis.com/marinacombo