

NEW LINER design_Gianluigi Landoni

177



IT_Descrizione prodotto

Divani, Divani componibili, Terminali lineari, Pouf

Caratteristiche tecniche

Struttura: Massello di abete.
Molleggio: Nastri elastici intrecciati.
Imbottitura: Poliuretano espanso.
Cuscini seduta: Poliuretano espanso a quote differenziate ricoperto in termofalda.
Cuscini schienale: Piuma lavata e sterilizzata mista a fibra poliestere siliconata.
Piedi: Legno noce canaletto o alluminio lucido.
Rivestimento: Rivestimento in tessuto o in pelle. Rivestimento in tessuto completamente sfoderabile.

EN_Description of the product

Sofas, Unit sofas, Linear end elements, Ottoman

Technical features

Frame: Solid fir-wood.
Springing: Interlaced elastic bands.
Padding: Polyurethane foam.
Seat cushions: Polyurethane foam with different densities covered with heated bonded polyester fibre.
Back cushions: Sterilized and washed feather mixed with silicone polyester fibre.
Feet: Canaletto walnut or bright aluminium.
Cover: Fabric or leather cover. Fabric cover completely removable.

- B - Espanso densità portante / Foam supporting density
- C - Espanso densità soft / Foam soft density
- L - Fusto in legno / Wooden frame
- PF - Piuma con fibra siliconata/ Feather mixed with silicon fibre
- R - Resinato / Heated bonded polyester fibre

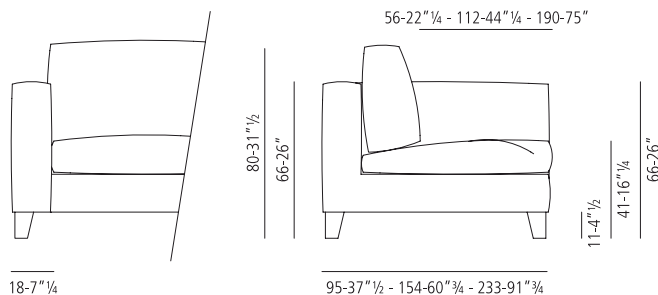
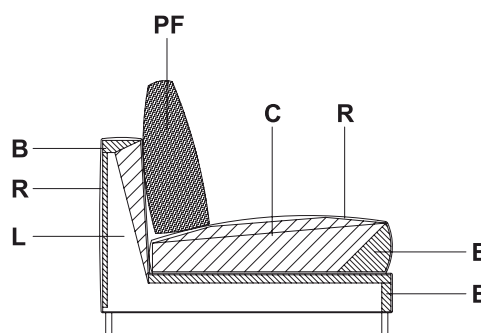

_bracciolo
_arm

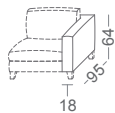

_poltrona 70 senza braccioli
_armchair 70 without arms

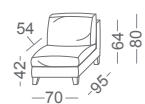

_poltrona 80 senza braccioli
_armchair 80 without arms

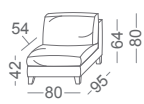

_poltrona 90 senza braccioli
_armchair 90 without arms

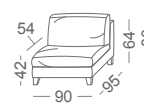

_divano 138 senza braccioli
_sofa 138 without arms

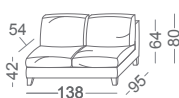

_divano 158 senza braccioli
_sofa 158 without arms

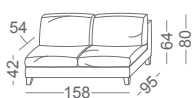

_divano 178 senza braccioli
_sofa 178 without arms



_divano 206 senza braccioli
_sofa 206 without arms

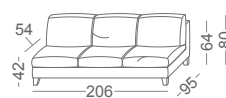

_divano 236 senza braccioli
_sofa 236 without arms

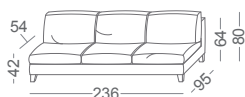

_angolo 95
_corner 95

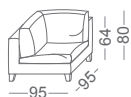

_angolo 174 dx/sx
_corner 174 l/r



_angolo 252 dx/sx
_corner 252 l/r

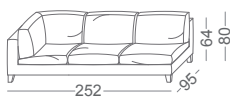

_terminale lineare 154 con bracciolo dx/sx
_linear end element 154 l/r with arm



_terminale lineare 233 con bracciolo dx/sx
_linear end element 233 l/r with arm



_pouf 95
_ottoman 95

