

CO507 01/05
CO508 05/01

SERIE HELEN

grupoKassandra

ES INSTRUCCIONES DE MONTAJE
GB INSTALLATION INSTRUCTIONS

FR INSTRUCTIONS D'INSTALLATION
DE MONTAGEANLEITUNG

ESQUEMA/SCHEME/SCHÉMA/SCHEMA

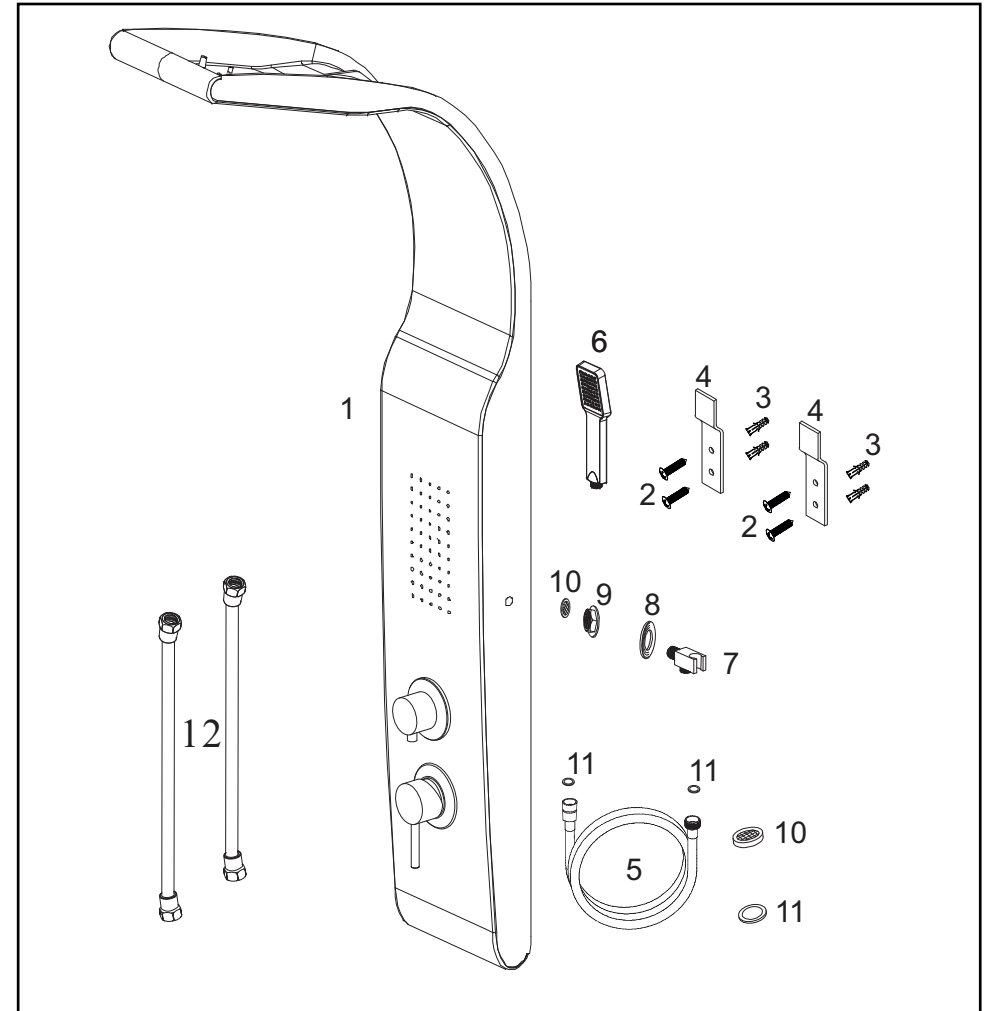

HERRAMIENTAS/TOOLS/OUTILLAGE/WERKZEUGE

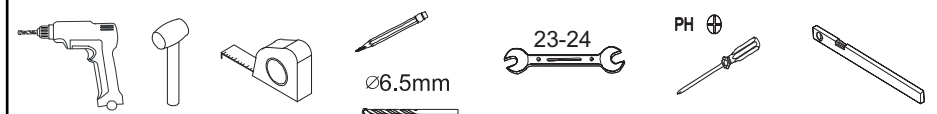















CO507 01/05
CO508 05/01

SERIE HELEN

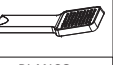
grupoKassandra

HERRAJES / FITTINGS / FERRURE / ZUBEHÖRTEILE

Nº	DIBUJO Y CODIGO	DESCRIPCION	UDS	UDS/ MAMP.	Nº	DIBUJO Y CODIGO	DESCRIPCION	UDS	UDS/ MAMP.	
1	 BLANCO-NEGRO CO5070100S131020	COLUMNA COLUMN COLONNE SPALTE	Uds Units Pcs Stk	1	10	 22HCOJUTOS002005	JUNTA CON MALLA BOARD WITH MESH CONSEIL D'UN MAILLAGE BOARD MIT MESH	Uds Units Pcs Stk	1	
	NEGRO-BLANCO CO5080500S131020					11	 22HCOJUTOS004005	JUNTA PARA FLEXO BOARD FOR SHOWER HOSE CONSEIL POUR TUYAU DE DOUCHE FÜR DUSCHE SCHLAUCH	Uds Units Pcs Stk	2
	 CG4070000S000040						CARTUCHO MONOMANDO 40 MM SINGLE LEVEL CARTRIDGE 40 MM CARTOUCHE À LEVIER UNIQUE 40 MM EINHEBEL-PATRONE 40 MM	Uds Units Pcs Stk	1	
2	 CG5100000S000035	CARTUCHO DESVIADOR 35 MM DIVERTER CARTRIDGE 35 MM CARTOUCHE DE DÉVIATION 35 MM UMLENK-PATRONE 35 MM	Uds Units Pcs Stk	1	12	 22HCOLAHIS002099	LATIGUILLAS 1/2" 50 cm FLEXIBLE TUBE 1/2" 50 cm TUBES ET TUYAUX FLEXIBLES 1/2" 50 cm SCHLÄUCHE 1/2" 50 cm	Uds Units Pcs Stk	2	
	 22MAATORNS539030	TORNILLO ST 3.9X30 SCREW ST 3.9X30 VIS ST 3.9X30 SCHRAUBE ST 3.9X30	Uds Units Pcs Stk	4		 PIEZAS MONTADAS				
3	 22MATACOS001006	TACO S-6 RAWLPLUG S-6 CHEVILLES S-6 DÜBEL S-6	Uds Units Pcs Stk	4						
4	 22HCOSOPAS011012	SOPORTE A PARED WALL OPORTE À PAROI WAND	Uds Units Pcs Stk	2						
5	 22HCOFLDUS012012	FLEXO SHOWER HOSE TUYAU DE DOUCHE DUSCHE SCHLAUCH	Uds Units Pcs Stk	1						
6	 BLANCO 22HCOMADUS013001	MANGO DE DUCHA TELEPHONE SHOWER TÉLÉPHONE DE DOUCHE TELEFON DUSCHE	Uds Units Pcs Stk	1	7		 22HCOSOMAS014012	SOPORTE MANGO DE DUCHA PHONE SUPPORT SHOWER SUPPORT TÉLÉPHONE DE DOUCHE SUPPORT PER TELEFON DUSCHE	Uds Units Pcs Stk	1
	NEGRO MATE 22HCOMADUS013005						8	 22HCOJUNTS001000	JUNTA PARA SOPORTE BOARD FOR SUPPORT CONSEIL POUR SOUVENIR BOARD FÜR SUPPORT	Uds Units Pcs Stk
9	 22MCOTUERS001000	TUERCA SCREW VISSER SCHRAUBEN	Uds Units Pcs Stk	1						

