



Access  
the  
inaccessible®

## CALL FOR INSPECTION FOR THE PETZL ASTRO AND CANYON GUIDE HARNESSSES

Request for inspection of ASTRO and CANYON GUIDE harnesses following the detection of a defect on the gated opening attachment point of an ASTRO harness. Due to the risk of unintentional opening of this attachment point, which could result in a life-threatening situation, we ask you to stop any use of these harnesses and to carry out immediately the following inspection.



ASTRO BOD FAST







ASTRO SIT FAST



CANYON GUIDE

Models covered by this request for inspection

Product name	Picture	Model/ References	Serial numbers concerned
<p><b>ASTRO BOD FAST european version</b></p>		<p>C083AA00 C083AA01 C083AA02</p>	<p>All serial numbers up to <b>23J 000000 000</b> included</p>
<p><b>ASTRO BOD FAST international version</b></p>		<p>C083BA00 C083BA01 C083BA02  C083BA03 C083BA04 C083BA05</p>	<p>All serial numbers up to <b>23J 000000 000</b> included</p>
<p><b>ASTRO SIT FAST</b></p>		<p>C085AA00 C085AA01 C085AA02</p>	<p>All serial numbers up to <b>23J 000000 000</b> included</p>
<p><b>CANYON GUIDE</b></p>		<p>C086BA00 C086BA01</p>	<p>All serial numbers up to <b>23J 000000 000</b> included</p>

## Origin and consequences of the defect

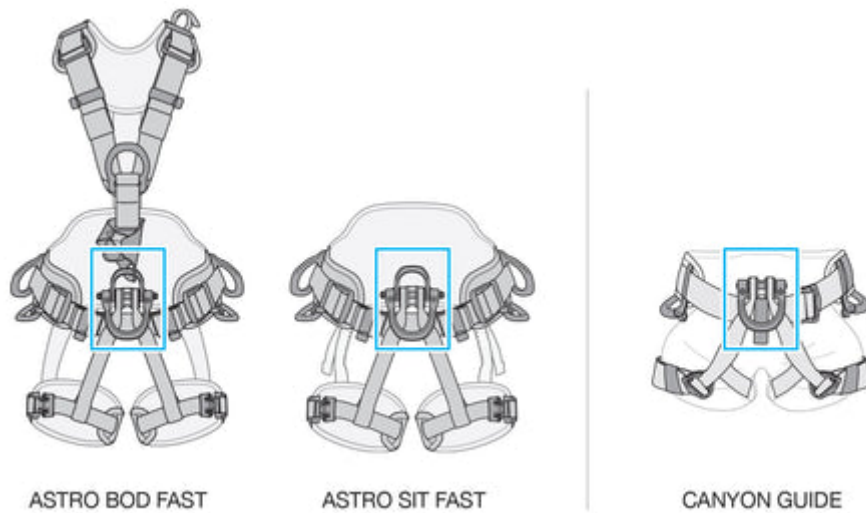



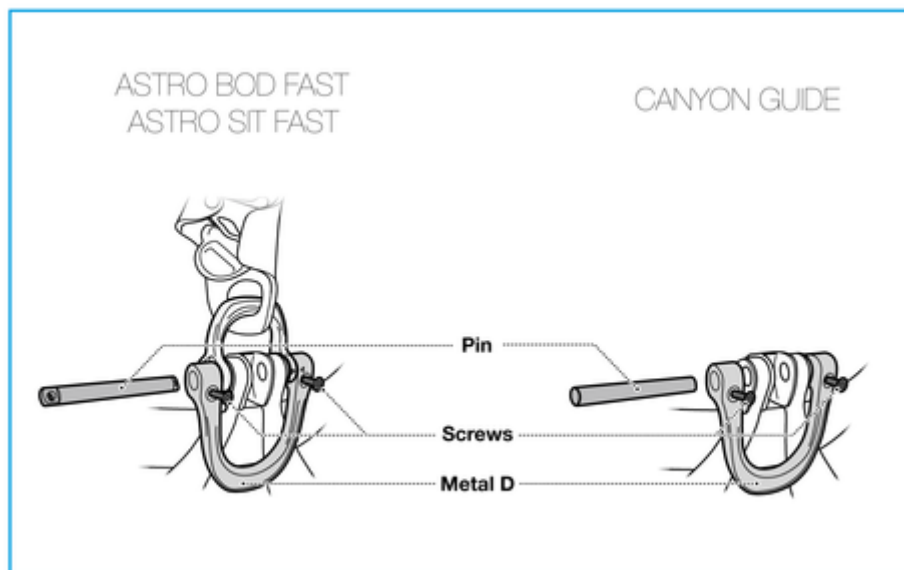



Components of the gated ventral attachment point:

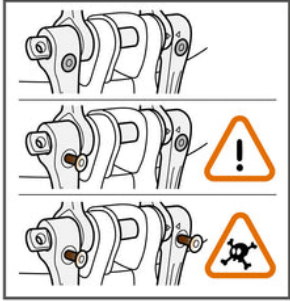
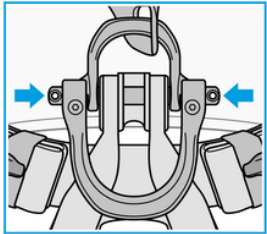

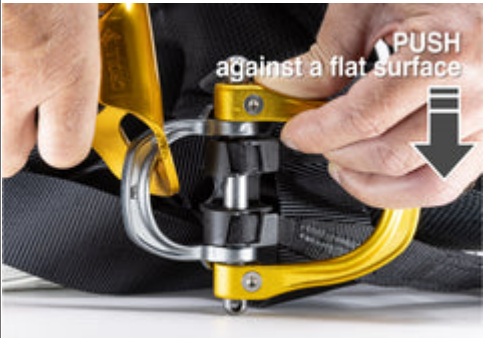
The defect is due to a poor machining process of the metal D. This can cause the pin to slide completely sideways, despite the presence of the 2 screws. This situation presents a risk of death due to strangulation or falling from a height.

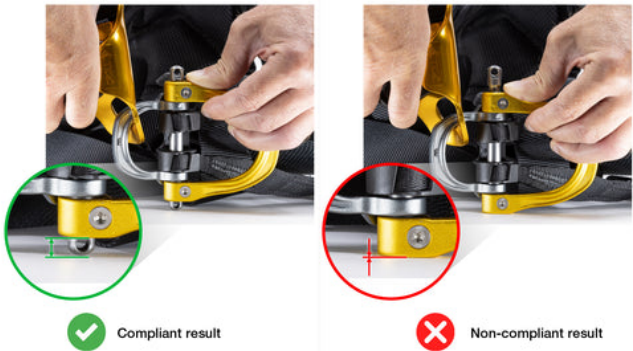
# Inspection and Test Procedure

ASTRO BOD FAST & ASTRO SIT FAST	CANYON GUIDE
<p><b>1) Prepare for the test:</b></p> <p>In accordance with the instructions for use, check that the 2 screws are present and correctly installed.</p>  <p>Remove any accessories mounted in the shackle connection holes.</p> 	<p><b>1) Prepare for the test:</b></p> <p>In accordance with the instructions for use, check that the 2 screws are present and correctly installed.</p> 
<p><b>2) Perform the test below:</b></p> 	<p><b>2) Perform the test below:</b></p> 
<p>The pin does not slide:      The pin slides out completely:</p> 	<p>The pin does not slide:      The pin slides out completely:</p> 

### 3) Test assessment:

#### A) Compliant result

1. Your product is not affected by this defect.
2. Go online using the button below and fill in the form below to enable Petzl to follow the progress of this request for inspection:

[Declaration Form](#)

#### B) Non-compliant result

1. Isolate the metal D.
2. Do not use this harness.
3. Quarantine it.
4. Contact your local Petzl support service via the form below. Our Support Team will then contact you with the relevant local support process, if you are in **Australia**, please use the relevant button below.

[END USER SUPPORT REQUEST](#)

OR

[STORE SUPPORT REQUEST](#)

#### C) If you have any doubts about how to perform the test

Please [contact your local support service team using this page](#).

## Safety Alert FAQ's

**Where can I find the serial number of my harness?**

The serial number is located on the plastic label inside the belt.

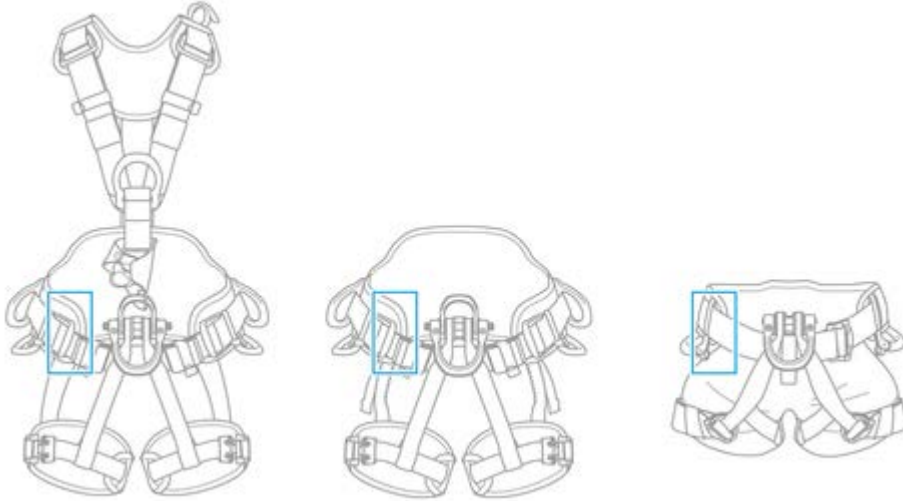

**Does this apply to all colours of metal D?**

Yes.

**Do I have to dismantle my gated ventral attachment point to perform this inspection?**

No.

**I have a lanyard installed on my harness. Do I have to remove it?**

No.

**Do I need to check that the screws are tightened to the correct torque?**

No, for this inspection, torque has no impact.

**I've never used my harness, do I need to inspect it?**

Yes.

**I'm already using my harness, do I need to inspect it?**

Yes.

**Is it necessary to apply high pressure on the pin to detect this defect?**

No, just a little pressure is necessary.

**During the test, the pin does not slide but I notice a slight play, is this normal?**

Yes, this is a normal functional play.

**Have there been any injuries with the products affected by this information?**

To date, no injuries have been reported.