

Date: _____ Location: _____
 Product: _____ Project: _____
 Quantity: _____ Catalog #: _____

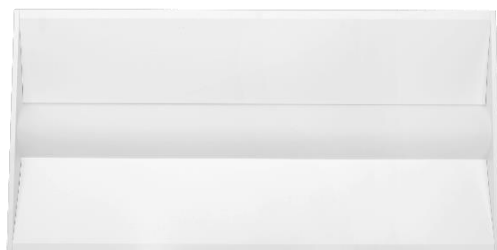

1x4
15W, 19W, 24W and 29W



2x4
24W, 29W, 32W and 39W

LED Multi Watt Multi CCT Troffer Series



2x2
15W, 19W, 24W and 29W

FEATURES

- Default Wattage is the highest wattage
 - 2x4 – 39W
 - 2x2 – 29W
 - 1x4 – 29W
- Default CCT: 5,000K
- Glare-free lighting
- 100,000 hours lifetime

SUITABLE APPLICATIONS

- Warehouses
- Schools
- Factories
- Offices
- Supermarkets
- Logistic Centers
- Exhibition Halls

CONSTRUCTION:

Steel and Aluminum frame. Matte white finish. The entire fixture functions as a heat sink to keep the LEDs cooler to prolong the life of the light.

OPTICAL SYSTEM:

Samsung 2835 LED chips. 150° beam angle.

WARRANTY:

5-year limited warranty. Actual performance may differ as a result of end-user environment and application.

ELECTRICAL:

120-277V input standard.
-20°C to 50°C, -4°F to 122°F

INSTALLATION & MOUNTING:

Fits most preexisting troffers. Surface mount kit and recessed kit.

CONTROLS & DIMMING:

0-10V dimming comes standard. Suitable for use with LED dimmers.



MODEL NUMBER – 3,500K, 4,000K and 5,000K	SIZE	WATTAGE	LUMENS	EFFICACY	CRI	POWER FACTOR	THD	REPLACES
LOC-14TROF-DMWMCCT	1x4	15W	2,118.9LM	141.26LM/W	82.2	0.9787	10.5%	150W HID
LOC-14TROF-DMWMCCT	1x4	19W	2,683.94LM	141.26LM/W				150W HID
LOC-14TROF-DMWMCCT	1x4	24W	3,390.24LM	141.26LM/W				150W HID
LOC-14TROF-DMWMCCT	1x4	29W	4,095.8LM	141.26LM/W				150W HID
LOC-22TROF-DMWMCCT	2x2	15W	2,109.75LM	140.65LM/W	82.1	0.9771	10.6%	150W HID
LOC-22TROF-DMWMCCT	2x2	19W	2,672.35LM	140.65LM/W				150W HID
LOC-22TROF-DMWMCCT	2x2	24W	3,375.6LM	140.65LM/W				150W HID
LOC-22TROF-DMWMCCT	2x2	29W	4,078.1LM	140.65LM/W				150W HID
LOC-24TROF-DMWMCCT	2x4	24W	3,262.32LM	135.93LM/W	82.6	0.9637	7.12%	200W HID
LOC-24TROF-DMWMCCT	2x4	29W	3,941.97LM	135.93LM/W				200W HID
LOC-24TROF-DMWMCCT	2x4	32W	4,349.76LM	135.93LM/W				200W HID
LOC-24TROF-DMWMCCT	2x4	39W	5,296.5LM	135.93LM/W				200W HID

Series	Size	Dimming	1x4 Wattage	2x2 Wattage	2x4 Wattage	Color Temperature
LOC-TROF	14 = 1x4 22 = 2x2 24 = 2x4	D = Dimmable	15W 19W 24W 29W	15W 19W 24W 29W	24W 29W 32W 39W	3500K 4000K 5000K

MEASUREMENTS

1x4

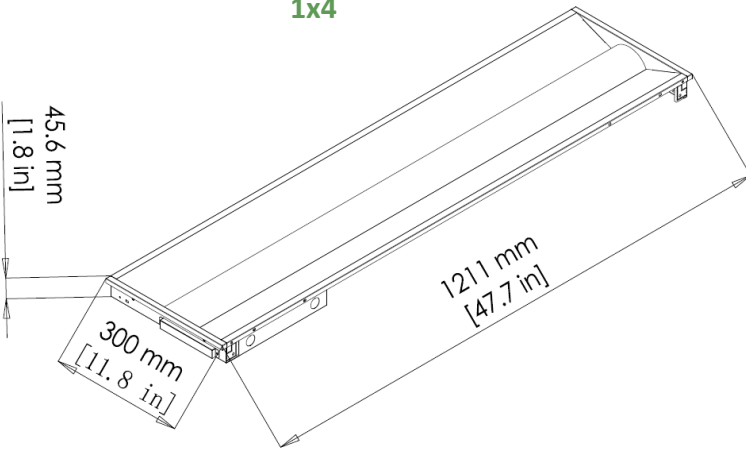

2x2

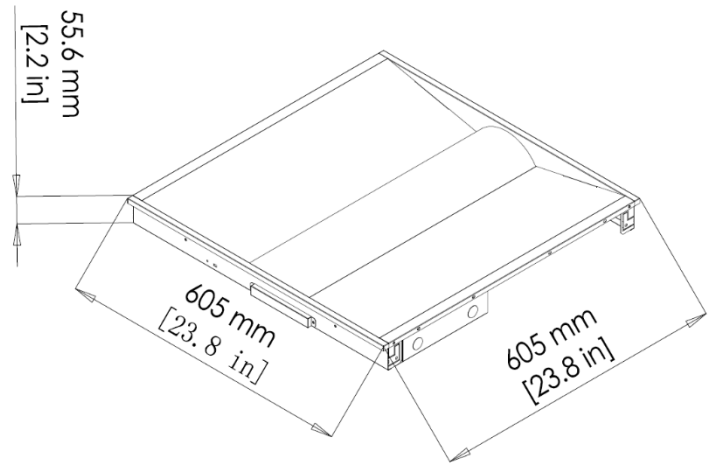

2x4

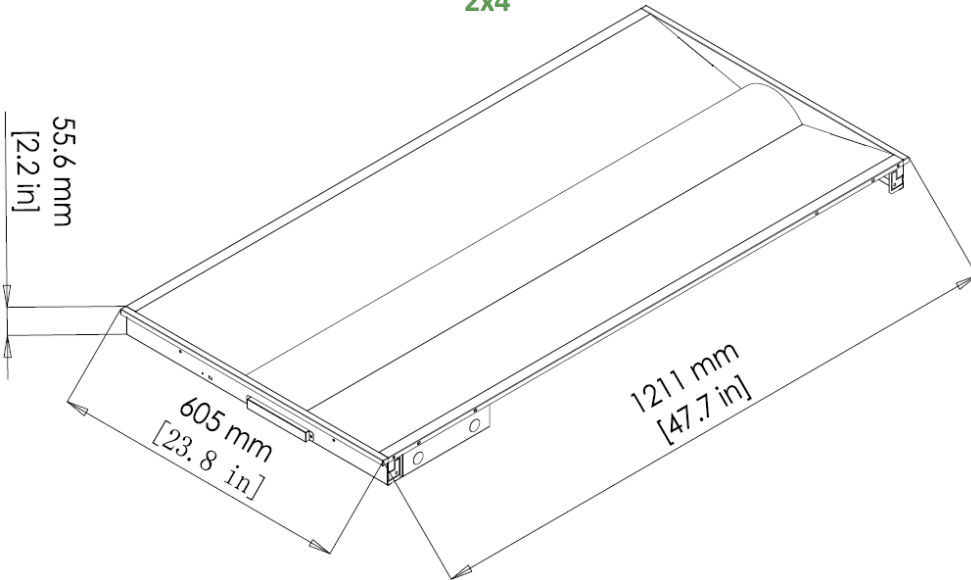

MODEL	QUANTITY	WEIGHT	UPC CODE
LOC-14TROF-DMWMCCT	1	lbs	00815586029921
LOC-22TROF-DMWMCCT	1	7.4 lbs	00815586020638
LOC-24TROF-DMWMCCT	1	11.15 lbs	00815586020553

1x4 15W

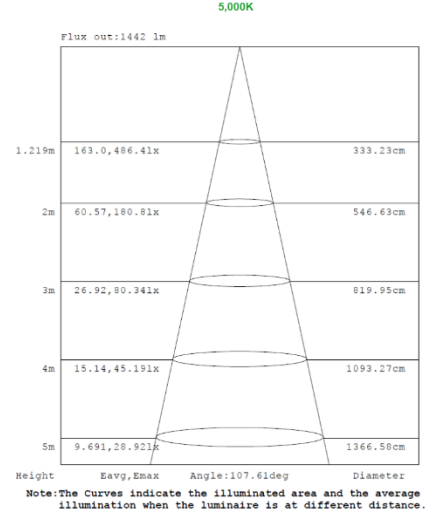
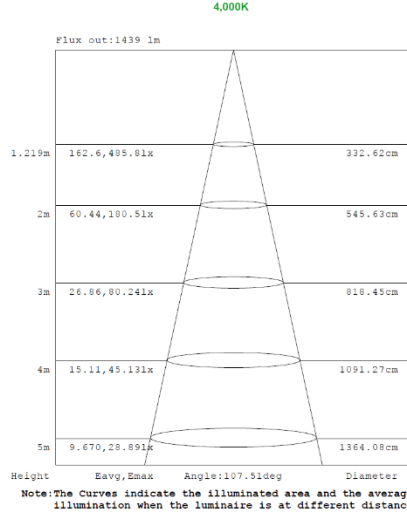
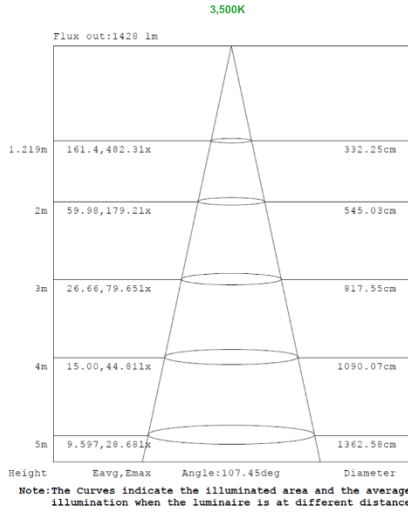
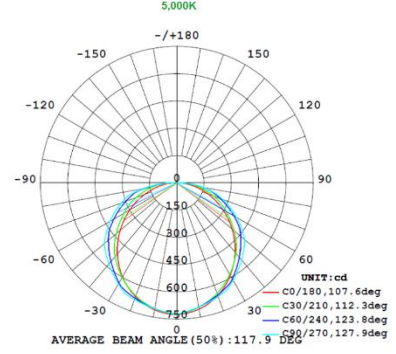
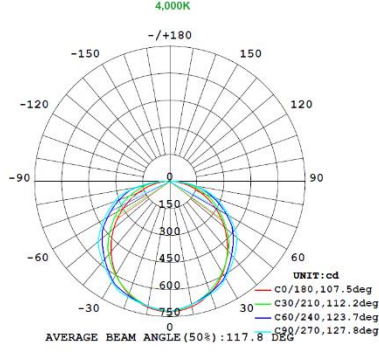
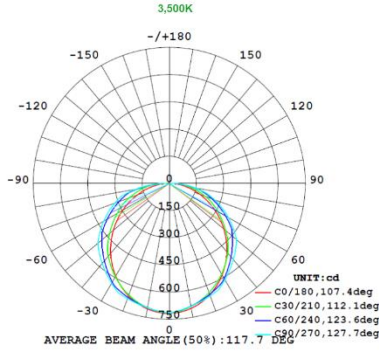

1x4 19W

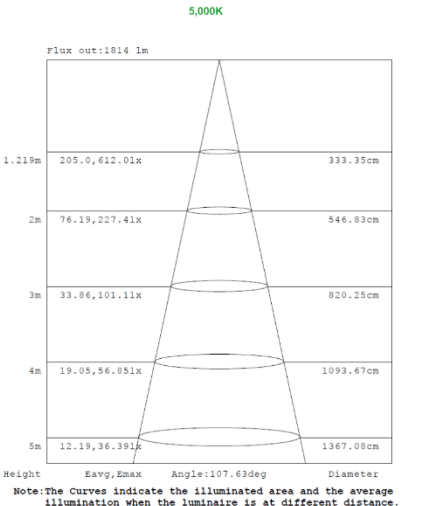
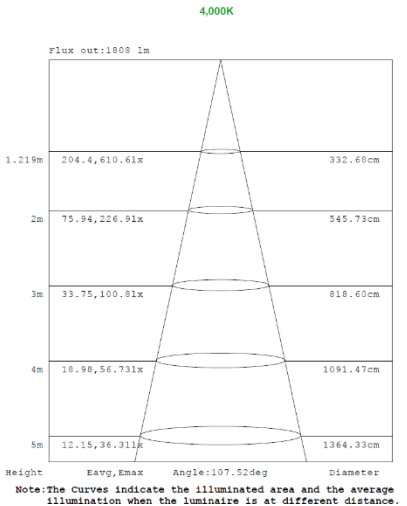
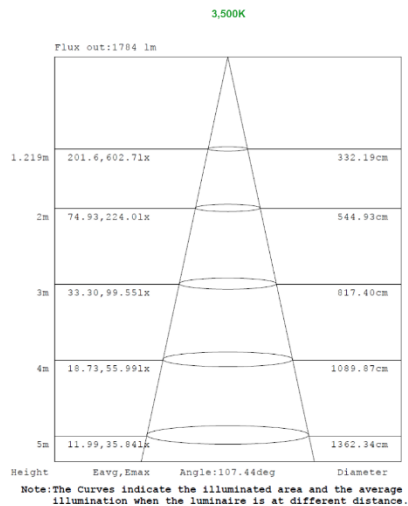
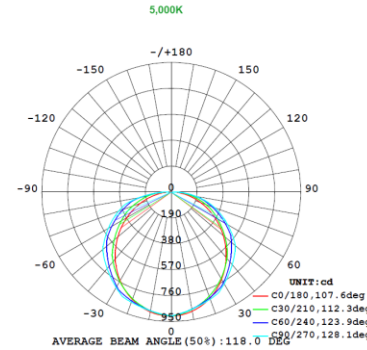
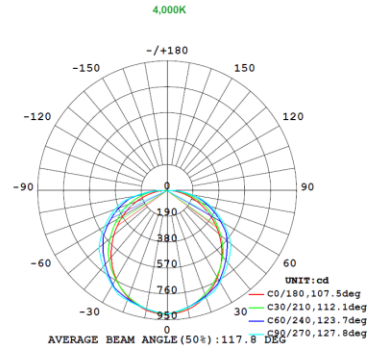
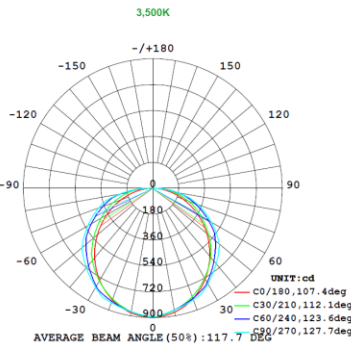

1x4 24W

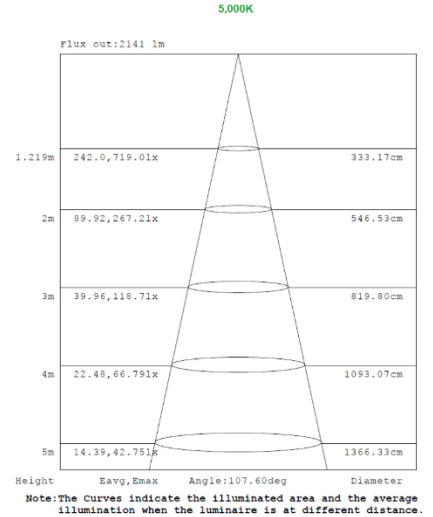
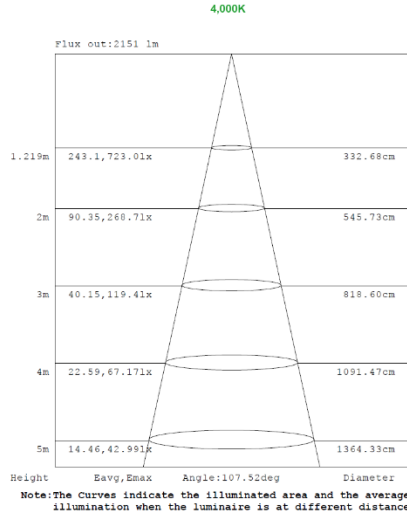
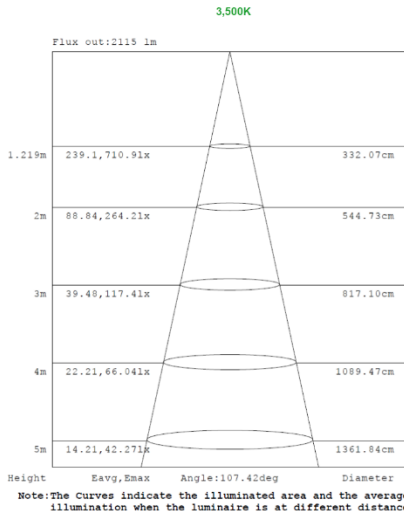
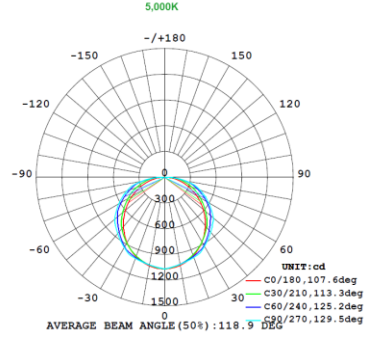
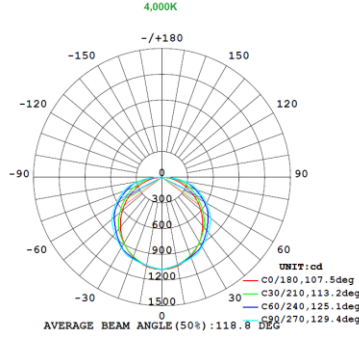
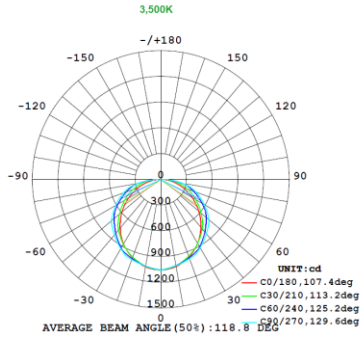

1x4 29W

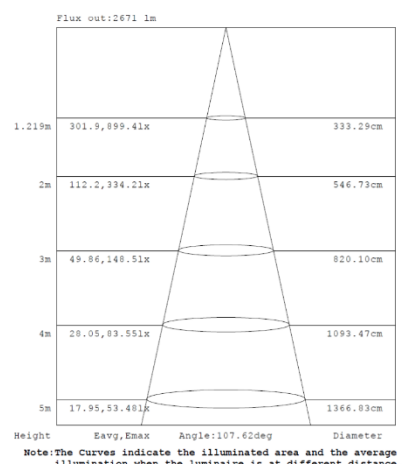
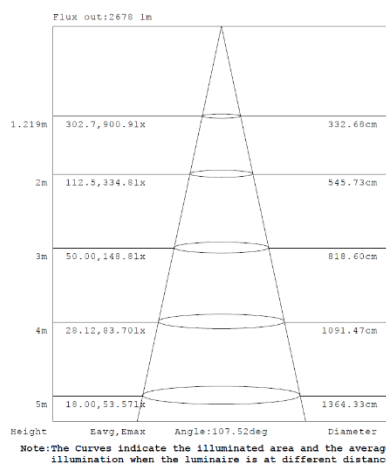
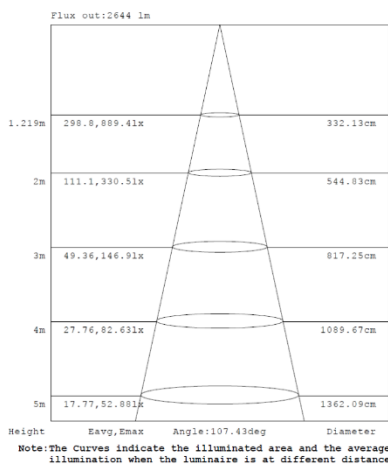
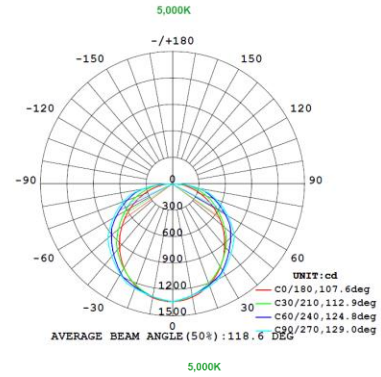
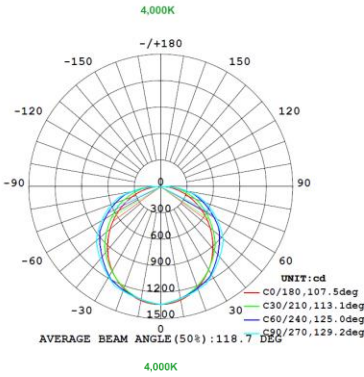
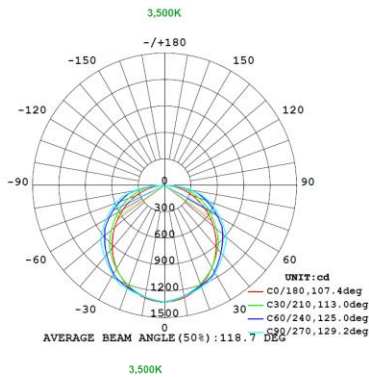

2x2 15W

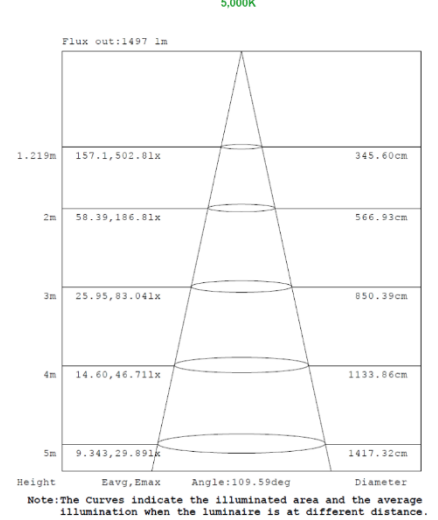
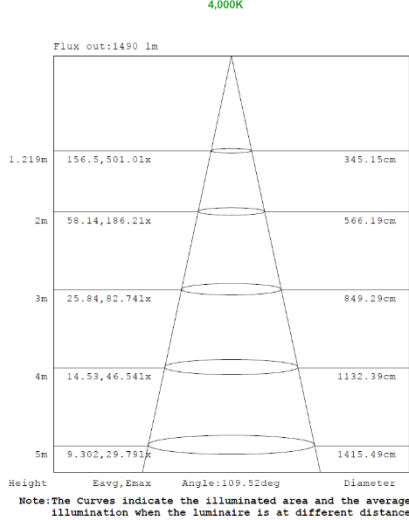
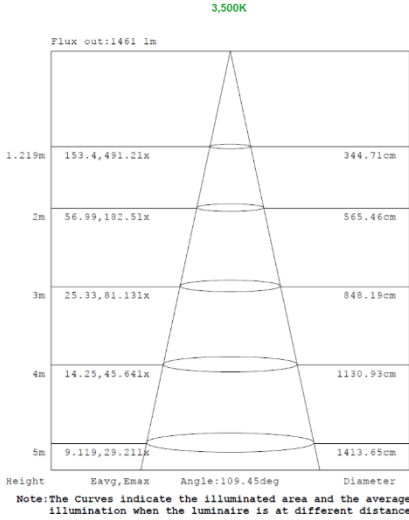
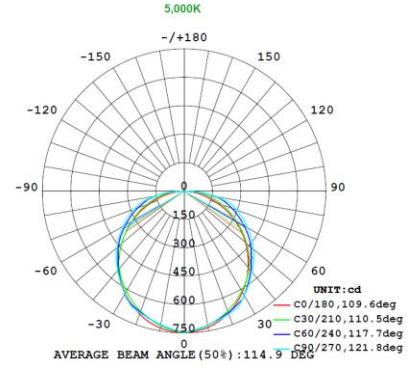
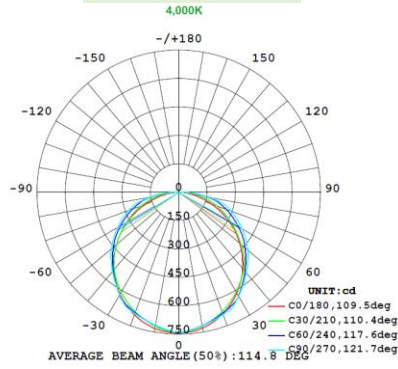
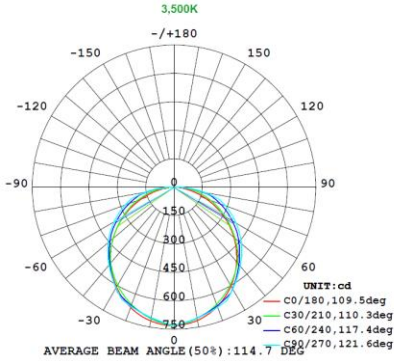

2x2 19W

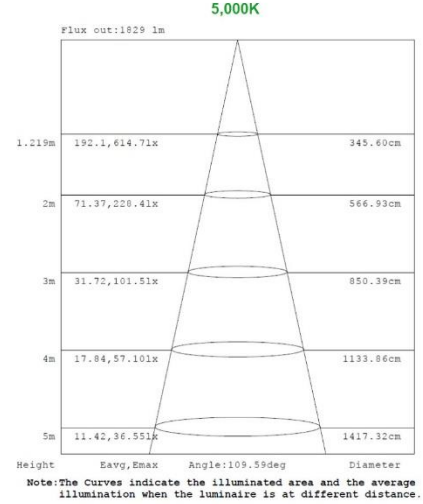
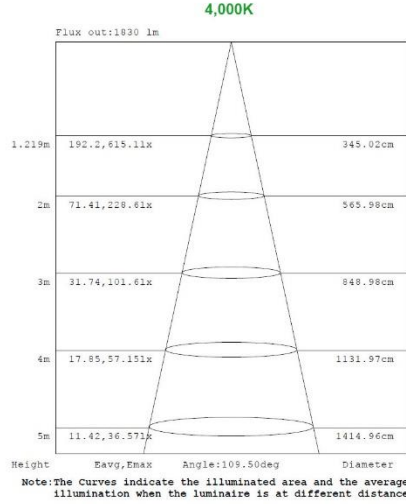
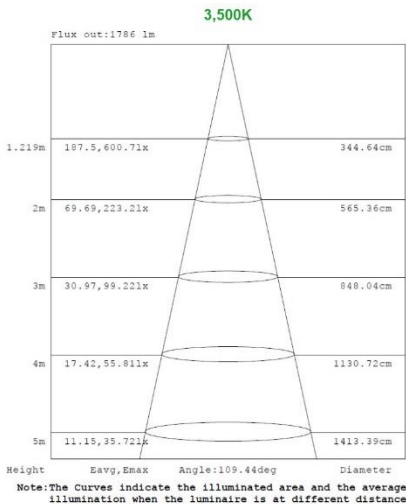
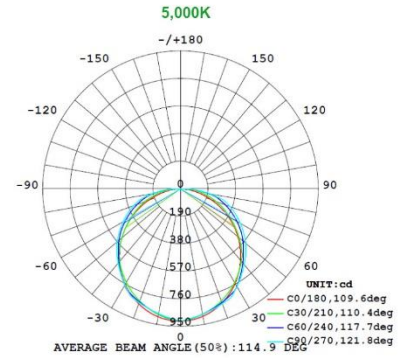
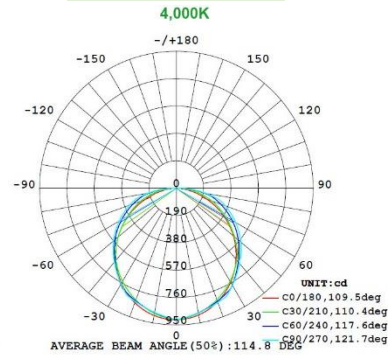
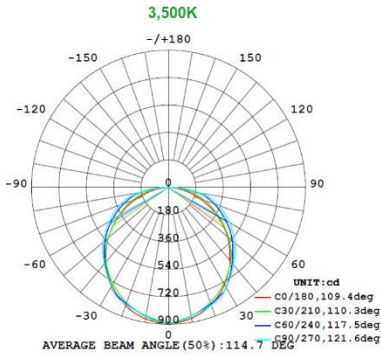

2x2 24W

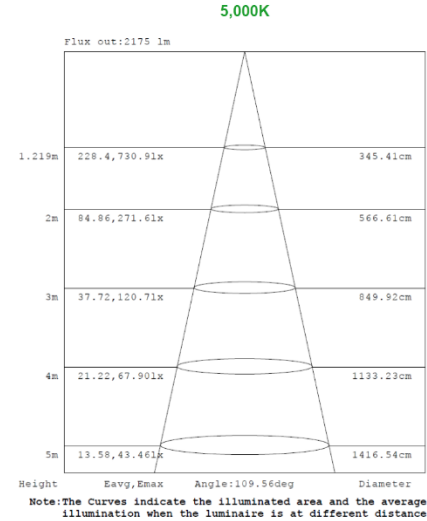
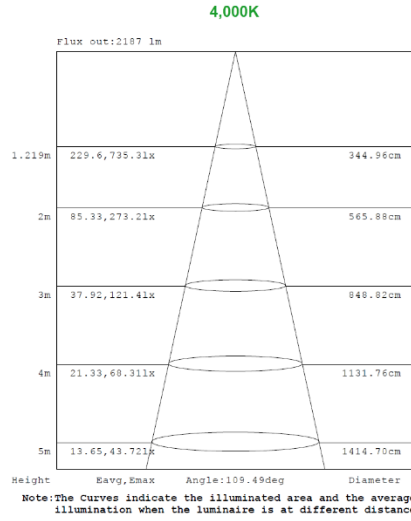
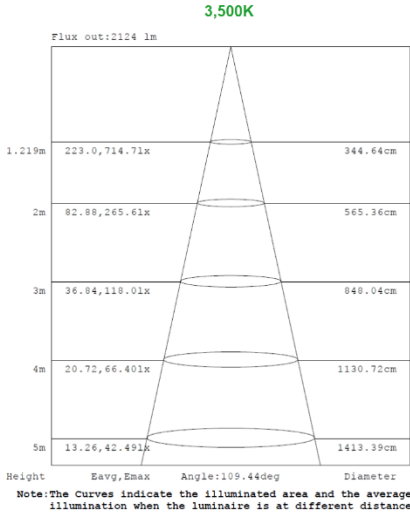
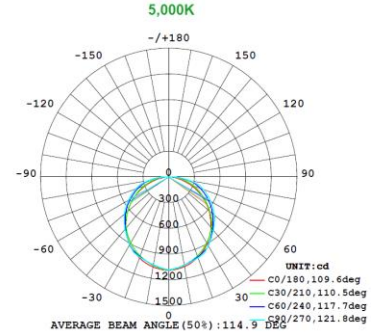
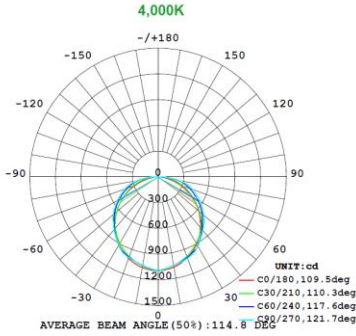
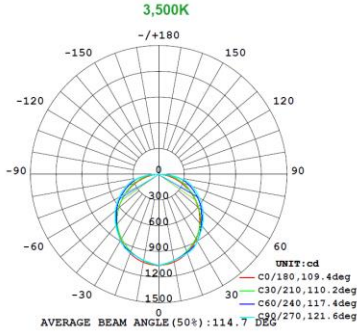

2x2 29W

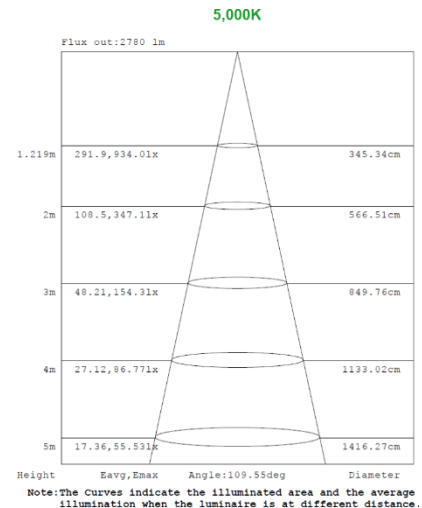
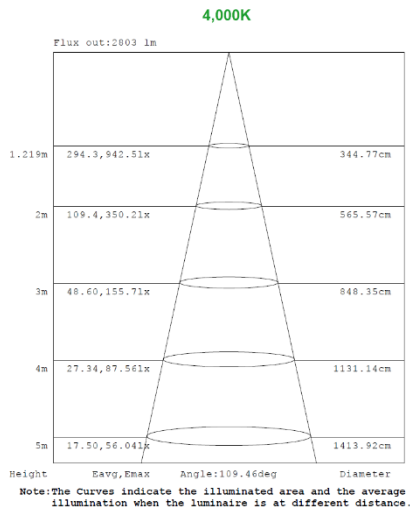
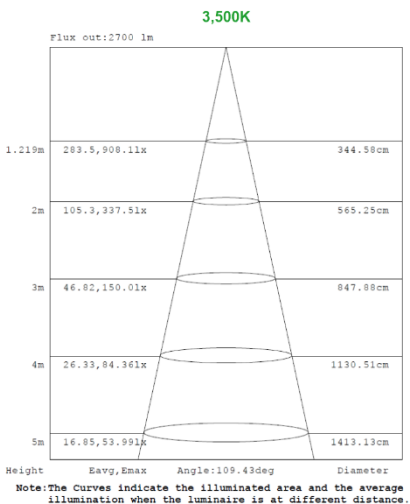
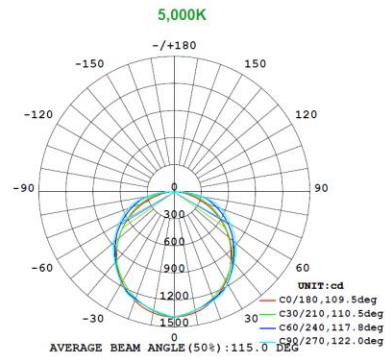
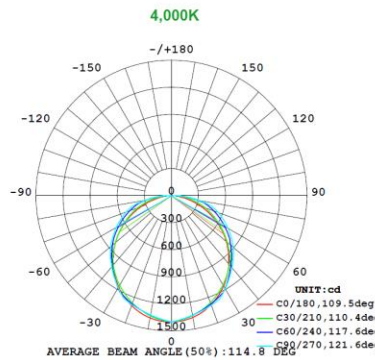
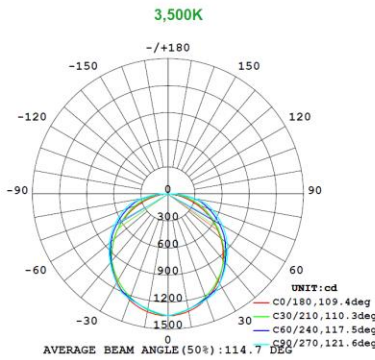

2x4 24W

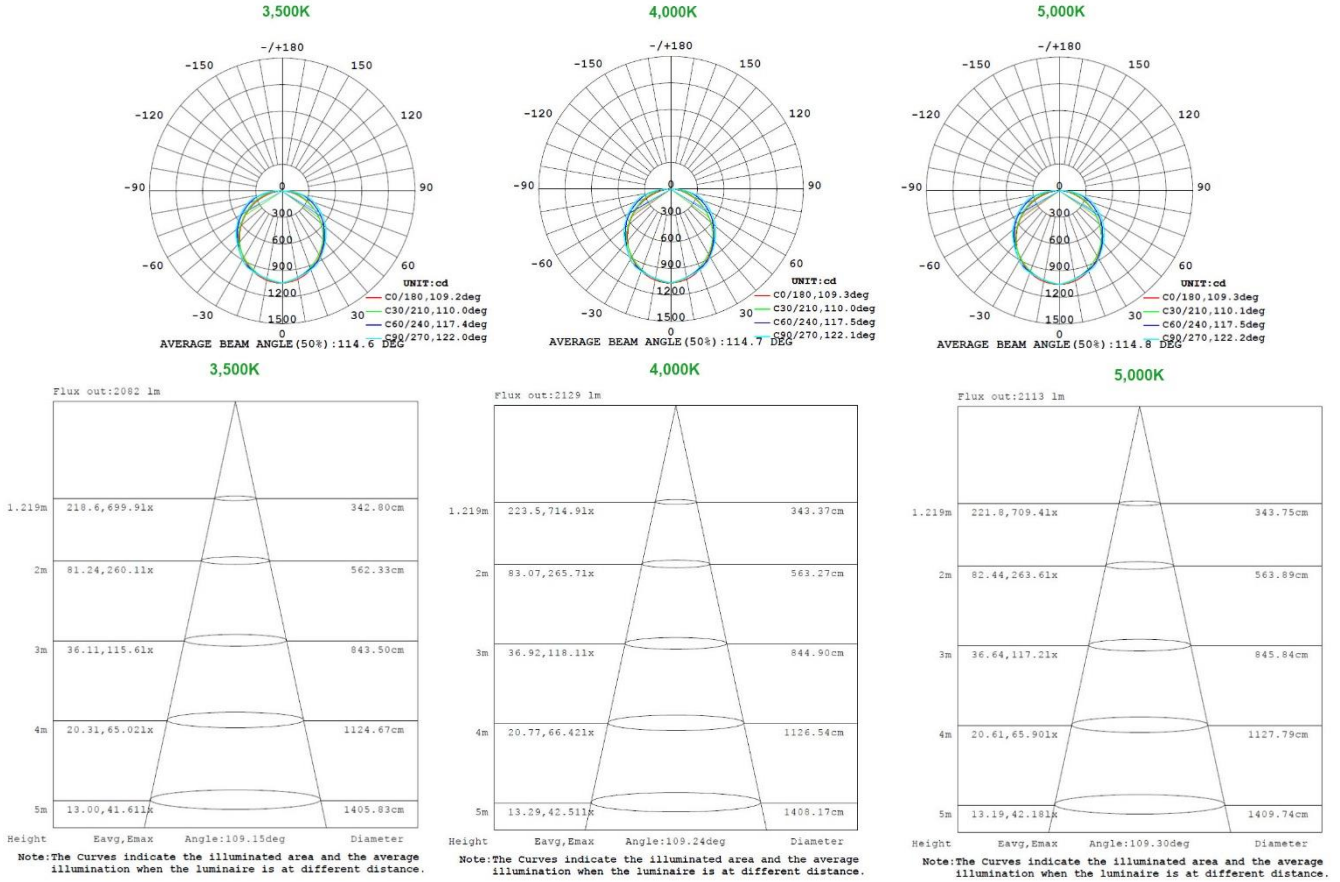

2x4 29W

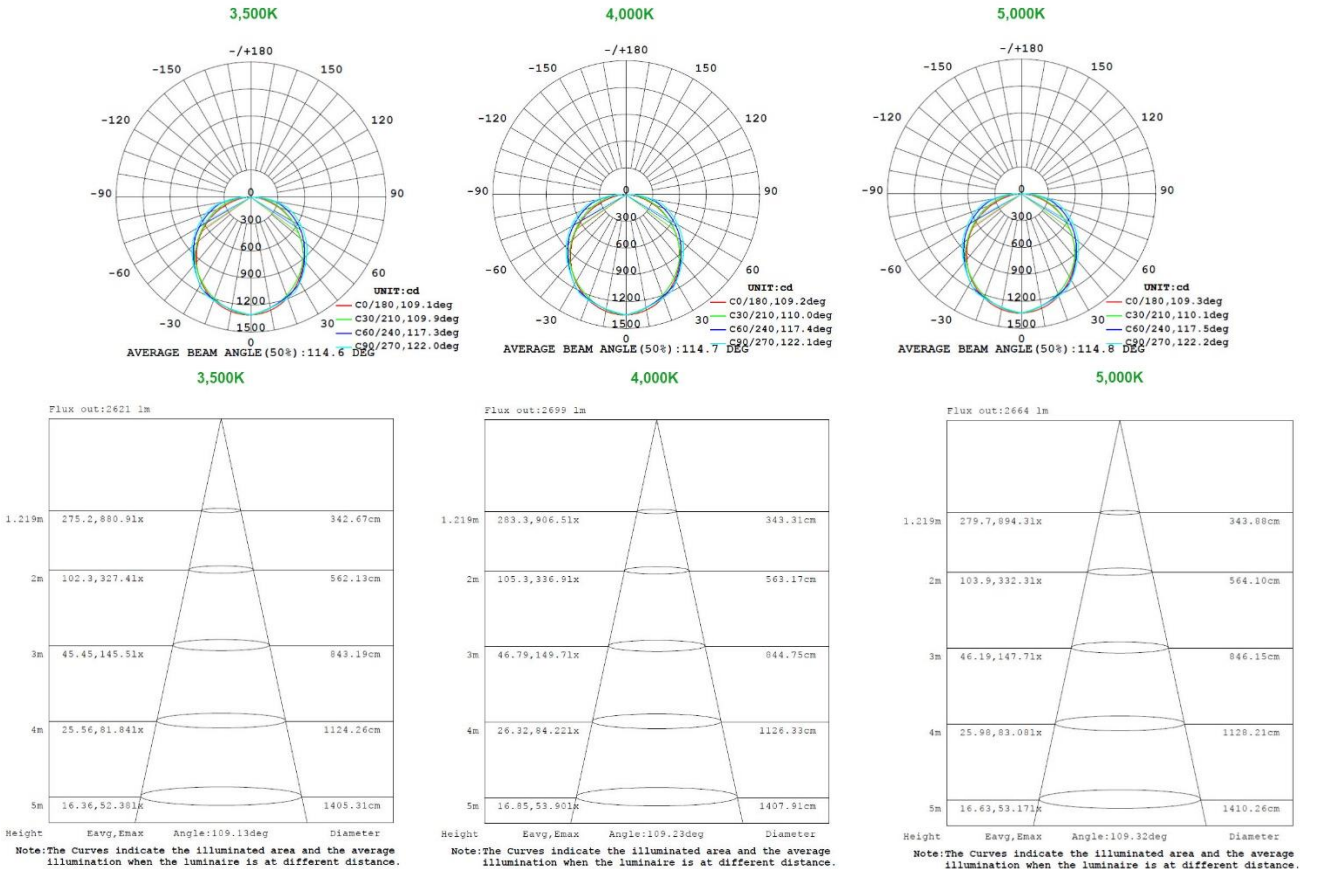

2x4 32W

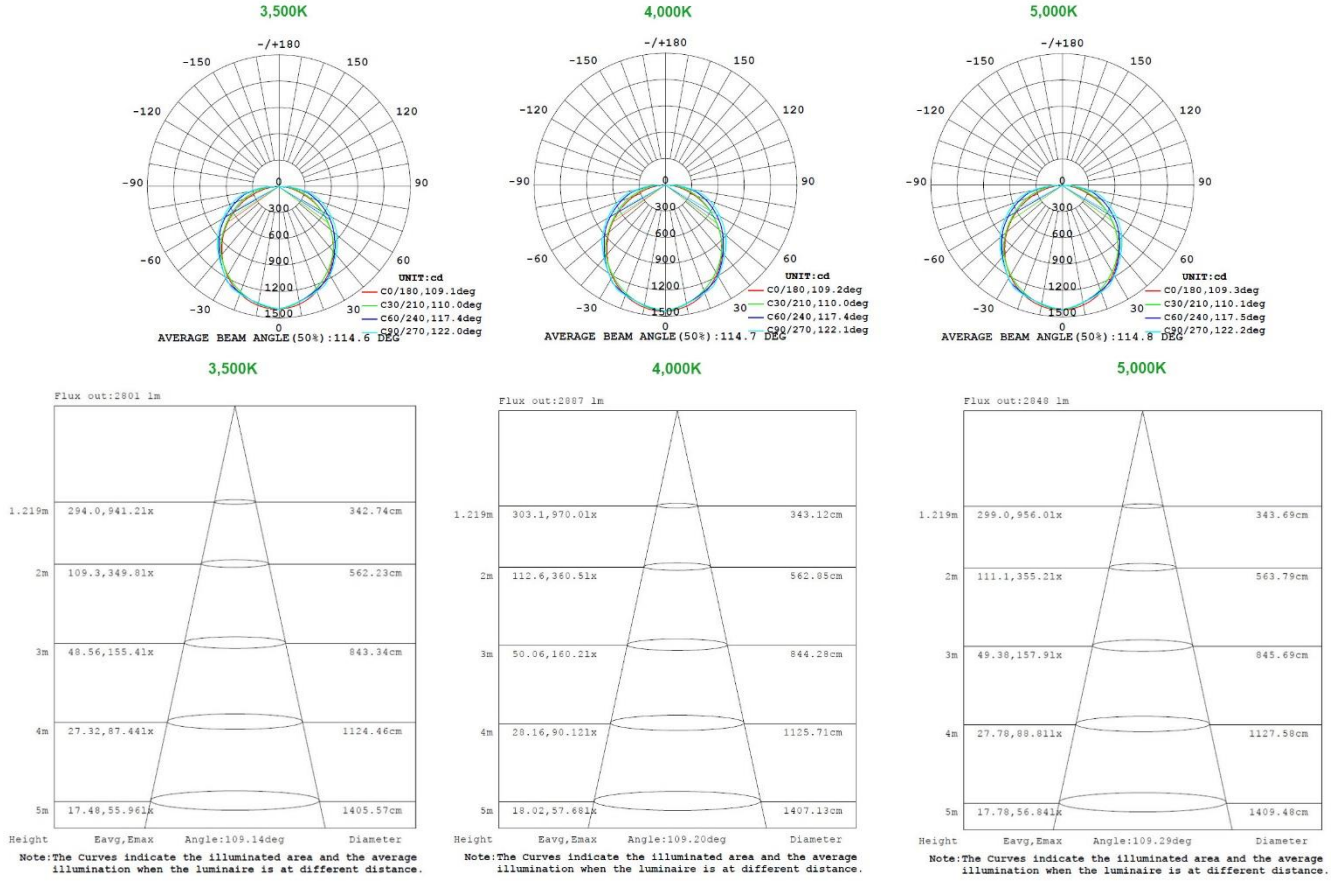

2x4 39W

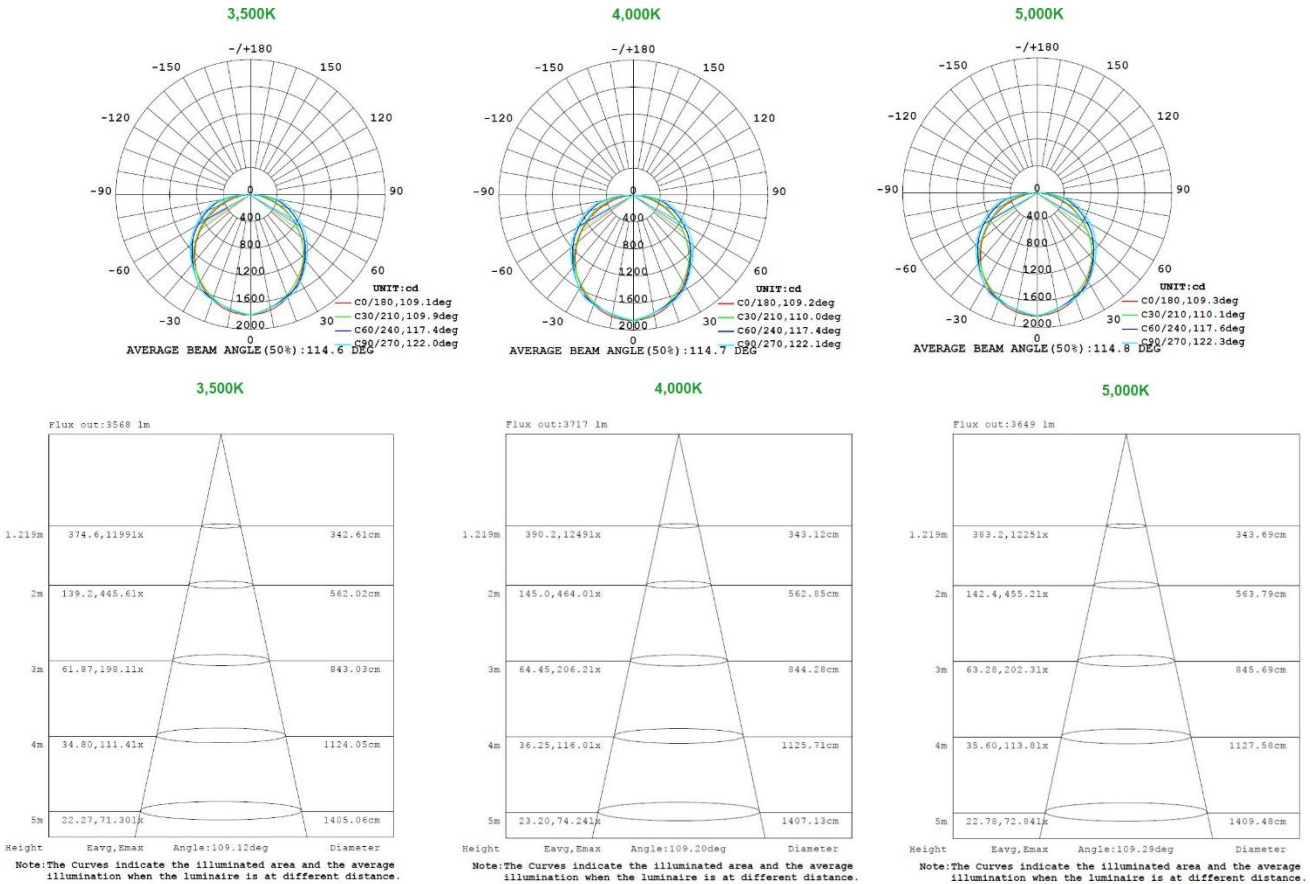

MOUNTING OPTIONS

Surface Mount

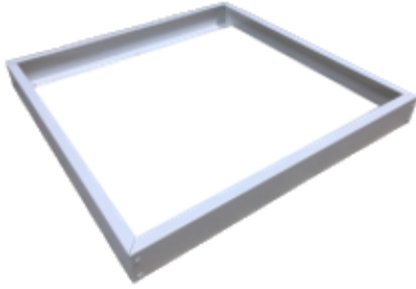

Recessed Mount



OPTIONAL ACCESSORIES



LOD-EXTED-M20W



LOC-AC-MS-QBL-DH-01
Bi-level daylight harvesting
microwave sensor

