

LawnMaster®

Instruction Manual

18cm 20V MAX* Lithium-Ion Cordless Robotic Lawnmower L10

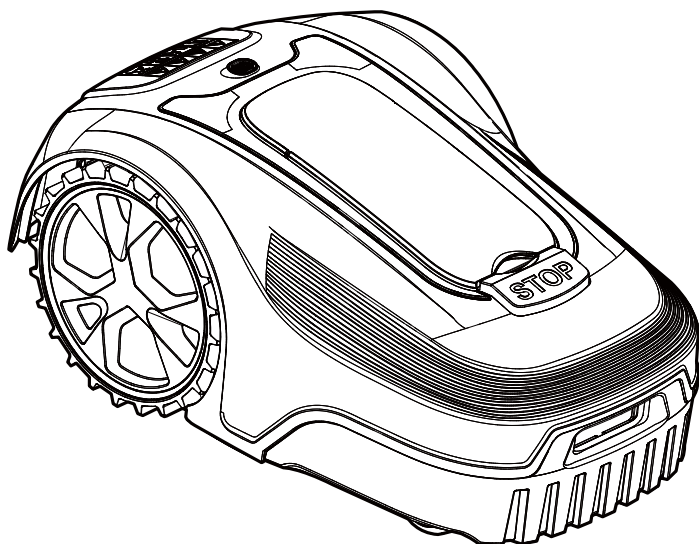

Original Instructions



WARNING: Read all safety instructions carefully before assembling and operating this machine. Ensure the machine has been assembled correctly and safely. Keep the instructions safe and pass them on to any subsequent user so that the information is always available.



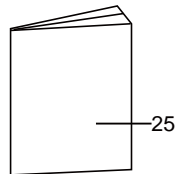
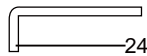
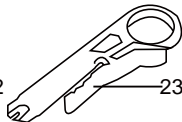
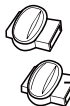
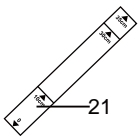
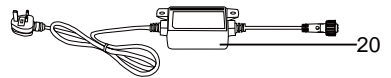
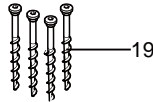
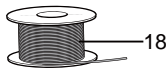
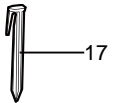
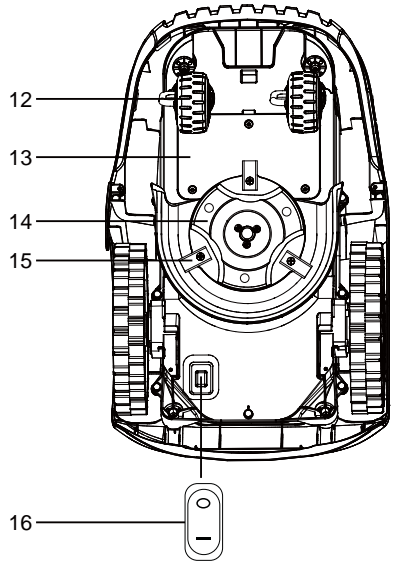
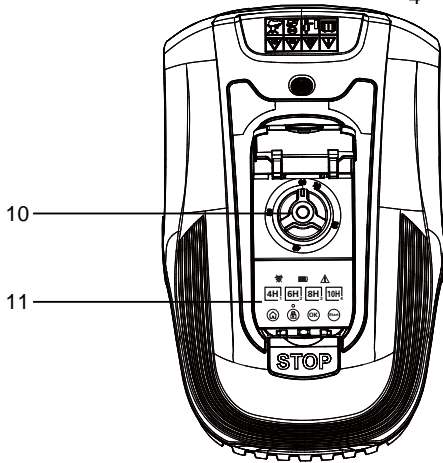
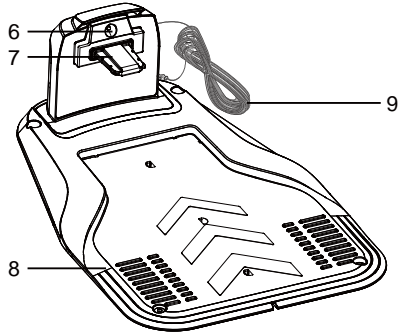
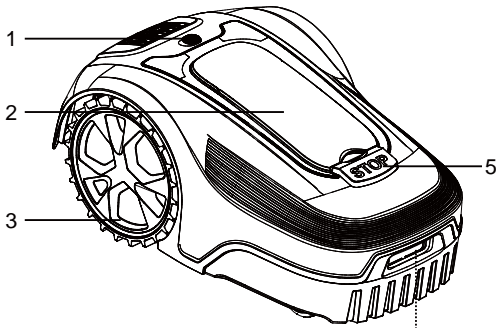

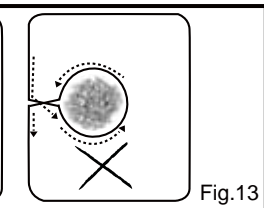
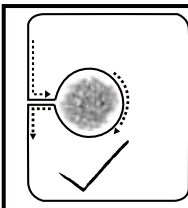
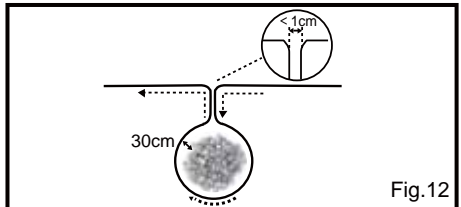
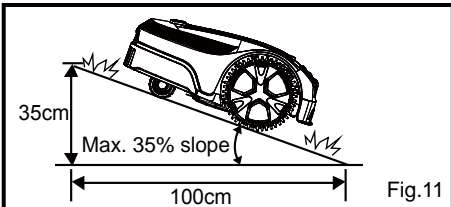
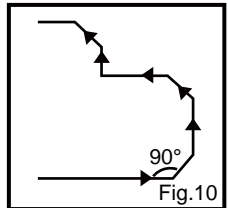
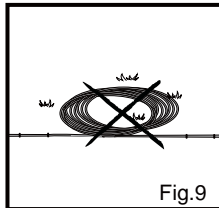
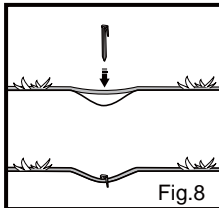
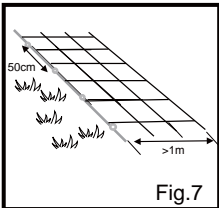
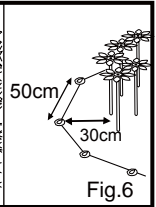
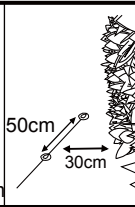
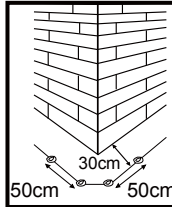
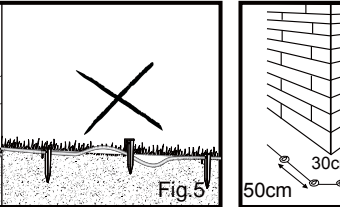
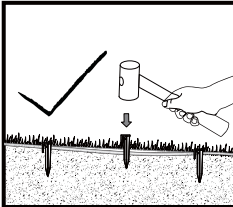
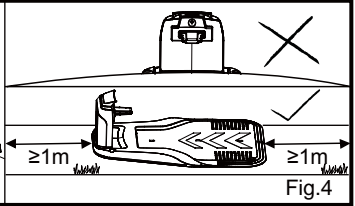
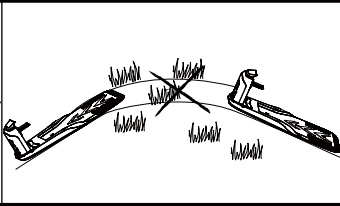
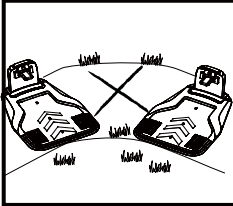
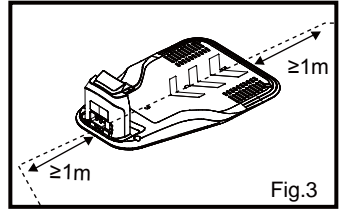
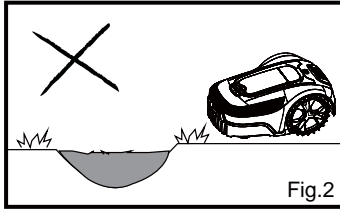
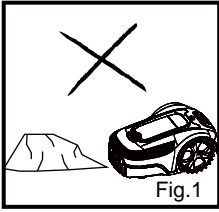

TABLE OF CONTENTS

| Section | Page |
|------------------------|-------------|
| Symbols | 5-6 |
| Safety Information | 7-12 |
| In the Box | 13 |
| Assembly | 14-19 |
| Operation | 20-25 |
| Maintenance | 26-28 |
| Troubleshooting | 29-34 |
| Specifications | 35-36 |
| Recycling and Disposal | 36 |

About This Product











Thank you for choosing the LawnMaster® L10 robotic lawnmower. This product independently mows the lawn in a random pattern before returning to the base station to charge the battery by navigating along the boundary wire. The boundary wire both helps the mower to find the charging station and enables the mower to understand where to mow in the garden. The mower will alternately mow and charge for the working time selected, before returning to the base station to standby until the next day.

Because the product mows little and often, small pieces of grass are returned to the surface of the grass. These clippings return nutrients back to the ground and cannot be seen by eye when regular use is in effect, giving the double benefit of both feeding the lawn and removing the need to dispose of grass clippings.







FOR YOUR SAFETY: CAREFULLY READ AND UNDERSTAND ALL INSTRUCTIONS.

SYMBOLS

The following warning symbols appear throughout this manual and indicate the appropriate safety measures you should take when operating and maintaining the appliance.

| SYMBOL | DESIGNATION/EXPLANATION |
|---|--|
|  | WARNING - The robotic lawnmower can be dangerous if used incorrectly. |
|  | Read instruction manual before operating the machine. |
|  | Keep bystanders away. |
|  | Remove the disabling device before working on or lifting the machine. |
|  | Operate the disabling device before working on or lifting the machine. |
|  | Do not ride on the machine. |
|  | Wait until all moving parts have stopped completely before touching them. The blade may continue to rotate after the machine is switched off, a rotating blade can cause injury. |
|  | Do not wash the machine with a high pressure washer. |
|  | WARNING! Beware of electric shocks. |
|  | Protection class II (Double insulation) |
|  | Class III machines. |

SYMBOLS

| SYMBOL | DESIGNATION/EXPLANATION |
|---|--|
|  | <p>The power cord must not be shortened, extended or spliced. Do not use a trimmer near the power cord. Be careful when trimming edges where the cables are placed. Operate the disabling device before you use or lift the product.</p> |
|  | <p>Electrical appliances must not be disposed of with the domestic waste.</p> |
|  | <p>Batteries contain Lithium-ion. Do not dispose of batteries in household waste.</p> |
|  | <p>Do not dispose of battery packs in rivers or immerse in water.</p> |
|  | <p>Do not dispose of battery packs in fire.</p> |
|  | <p>Do not subject the battery to direct sunlight over long periods and do not leave it on or near a heat source (max. 60°C).</p> |
|  | <p>Recycle electrical waste products in an environmentally safe way where facilities exist.</p> |

WARNING

To avoid serious personal injury, do not attempt to use this product until you read thoroughly and understand completely the instruction manual.

If you do not understand the warnings and instructions in the instruction manual, do not use this product.

SAFETY INFORMATION

IMPORTANT !

READ CAREFULLY BEFORE USE. KEEP FOR FUTURE REFERENCE

Training

- Read the instructions carefully. Be familiar with the controls and the proper use of the machine.
- Never allow people unfamiliar with these instructions or children to use the machine. Local regulations may restrict the age of the operator.
- The operator or user is responsible for accidents or hazards occurring to other people or their property.
- The operator or user is responsible for informing neighbours about the risks. Keep a safe distance from the machine when operating.
- If your lawn is open to the street and/or your neighbours, you must be present during the mower's operation to prevent others from accessing your lawn. Alternatively, you must protect / fence your lawn so that others do not access the mower during operation.
- This appliance is not intended for use by persons (including children) with reduced physical, sensory or mental capabilities, or lack of experience and knowledge, unless they have been given supervision or instruction concerning use of the appliance by a person responsible for their safety. Children should be supervised to ensure that they do not play with the appliance.

WARNING

The robotic lawnmower can be dangerous if used incorrectly.

SAFETY INFORMATION

WARNING

Never use the robotic lawnmower when people, especially children or pets, are in the cutting area.

Preparation

- Ensure the correct installation of the boundary wire as instructed.
- Periodically inspect the area where the machine is to be used and remove all stones, sticks, wires, pet toys, and other foreign objects.
- Periodically visually inspect to see that the blades, blade bolts and cutter assembly are not worn or damaged. Replace worn or damaged blades and bolts in sets to preserve balance.
- On multi-spindle machines, take care as rotating one blade can cause other blades to rotate.

Operation

- Do not leave the machine to operate unattended if you know that there are pets, children or people in the vicinity.
- Never operate the machine with defective guards, or without safety devices, for example deflectors in place.
- Do not put hands or feet near or under rotating parts. Do not touch moving hazardous parts before these have come to a complete stop. Keep clear of the discharge opening at all times.
- Never pick up or carry a machine while the motor is running.
- Always switch off the On/Off switch:

SAFETY INFORMATION

- Before clearing a blockage;
- Before checking, cleaning or working on the machine.
- It is recommended not to connect a damaged cord to the supply or touch a damaged cord before it is disconnected from the supply as this can lead to contact with live parts.
- It is not permitted to modify the original design of the mower. All modifications are made at your own risk.
- Keep extension cords away from moving hazardous parts to avoid damage to the cords which can lead to contact with live parts.
- Recommendations
 - To connect the machine and/or its peripherals only to a supply circuit protected by a residual current device (RCD) with a tripping current of not more than 30 mA,
 - To avoid using the machine and its peripherals in bad weather conditions especially when there is a risk of lightning;
- Disconnect the machine or its peripherals from the mains, if the cord becomes damaged or entangled during use.
- Do not use the mower for any purpose other than cutting lawn.
- In the event of accident or breakdown whilst the mower is operating, immediately press the STOP button.
- Do not put anything on top of the mower or its base station.
- Do not use the mower if the On/Off switch does not work.
- Always switch off the mower using the On/Off Switch when the mower is not in use.
- Metal objects in the ground (for example reinforced concrete or anti-mole nets) can result in a stoppage. The metal objects can cause interference with the loop signal

SAFETY INFORMATION

which then can lead to a stoppage.

- The robotic lawnmower must never be stored, operated or charged in temperatures below 0 °C or above 50 °C. This might cause damage to the product.
- Mow only in daylight or in good artificial light.
- Avoid operating the machine in wet grass.
- Do not operate the machine when barefoot or wearing open sandals. Always wear substantial footwear and long trousers.
- Always be sure of your footing on slopes.
- Always switch on the motor according to instructions with feet well away from the blade(s).

Maintenance and storage

- Keep all nuts, bolts, and screws tight to be sure the machine is in safe working condition.
- Replace worn or damaged parts for safety.
- Ensure that only replacement blades of the right type are used.
- In the event of leakage of electrolyte flush with water/ neutralizing agent, seek medical help if it comes into contact with the eyes, etc.
- Servicing of the machine should be according to manufacturers' instructions.
- In case of abnormal vibrations, stop the mower, switch off the On/Off switch and check for any damage of the blade. Replace a worn or damaged blade to preserve balance. If the vibration continues, call for service.
- Use heavy gloves when inspecting or servicing blades.
- Use only original equipment and accessories. It is not

SAFETY INFORMATION

permitted to modify the original design of the mower. All modifications are made at your own risk.

WARNING

Do not lift the mower when it is parked in the base station. It can damage the base station and/or the mower. Press STOP button and pull the mower out of the base station before lifting it.

WARNING

Disconnect all connections to the base station (power supply and boundary wire) if there is a risk of a thunderstorm.

Transportation

Within the working area:

- Press the STOP button to stop the mower. Use both hands to carry the mower at the front and rear sections under the mower. Carry the mower with the blade disc away from the body.

Long distances:

- When transporting your mower over long distances, press the STOP button and flip the On/Off switch to the “O” OFF position.
- **IMPORTANT!** It is recommended to keep the original packaging to avoid damage during transportation over long distances.

SAFETY INFORMATION

Battery

- Do not open up the battery and avoid mechanical damage to the battery.
- Under extreme usage or temperature conditions, battery leakage may occur. If liquid comes in contact with your skin, wash immediately with soap and water. If liquid gets into your eyes, flush them with clean water for at least 10 minutes, then seek immediate medical attention.
- Ensure that the battery is charged using the correct charger recommended by the manufacturer. Incorrect use may result in electric shock, overheating or leakage of corrosive liquid from the battery.

Product end of use

- The mower and its accessories should be collected separately at the end of their life to prevent waste electrical and electronic equipment from ending up in landfill sites, and to protect and improve the quality of the environment.
- Do not dispose of the mower or any other of its parts (including the Power Supply and Base Station) as unsorted municipal waste - they should be collected separately.
- Ask your local distributor/dealer about return and collection systems availability.
- Do not dispose of the battery pack in a fire, and do not place used batteries in your household trash.
- Dispose of batteries in accordance with the local regulations where they will be recycled in an environmentally friendly manner.

IN THE BOX (Refer to Page 2)

1. Rain Sensor
2. Hatch to Control Panel
3. Rear Wheel
4. Charging Strips
5. STOP Button
6. LED on the Base Station
7. Contact Strip
8. Base Station
9. Power Cord
10. Cutting Height Adjustment Knob
11. Control Panel
12. Front wheel
13. Battery Cover
14. Blade Turning Disc
15. Blade
16. On/Off Switch
17. Wire Peg (x250)
18. Boundary Wire
19. Base Station Fixing Screw (x4)
20. Power Adaptor
21. Measurement Gauge on the Box
22. Couplers for Boundary Wire (x2)
23. Wire Stripper
24. Hex Key
25. Instruction Manual

ASSEMBLY

Preparation

- Carefully remove all contents from the product packaging.
- Ensure you have all the accessories and tool(s) needed for assembly and operation. This also includes suitable personal protective equipment.
- During installation of the base station and the boundary wire, you will also need: rubber mallet and pliers (not included in the box).

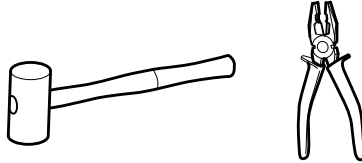

Know Your Lawn (See Figs. 1-2)

Understanding your lawn will reduce unnecessary mistakes and make the whole installation process easier and smoother.

- If there are stones on the lawn that may damage the mower, they should be removed or excluded from the working area (Fig. 1).
- Inspect the lawn for holes or hollows. Fill them with topsoil to prevent rainwater from forming pools of water on the lawn and to prevent mower from becoming stuck. The mower may be damaged if it is operated in pools of water (Fig. 2).
- Before laying the boundary wire, it is recommended to use the old lawn mower or grass trimmer to cut the grass very low on your lawn. This will help insert wire pegs easier, and the boundary wire can be laid as close as possible to the ground to protect the boundary wire from being cut by the mower.

Select the Proper Base Station Location (See Figs. 3-4)

The base station sends safe, low voltage control signals along the boundary wire and charges the robotic mower. It is important to select a proper location for the base station.

- Make sure a minimum 1m of straight wire is laid in front of the edge of the plate and behind the base station to allow smooth docking (Fig. 3).
- The whole power cord is no more than 10m. Make sure the base station is near a wall outlet.
- The level surface to place the base station on is free of any sharp objects.
- The mower can be operated in multi-zone lawns. Place the base station in the largest zone if there are additional zones in your lawn.
- The surface the base station is located on should be shady, even and flat.
- It is recommended to place the base station in a dry and sheltered location.

NOTE: The base station should be placed on relatively level ground. The ground on each side of the base station should be level for minimum 1m without corners, slopes or obstacles to ensure proper docking (Fig. 4).

ASSEMBLY

NOTE: If desired, to save initial set-up time the robotic mower can be charged in the unsecured base station while the boundary wire is laid. Make sure the contact strip on the base station and the charging strips on the mower are connected properly. The robotic mower will be ready to mow immediately after connecting the boundary wire to the base station. Ensure that the base station is disconnected from the power source when connecting the boundary wires to the terminals. Refer to page 18 for connecting the base station to the power source.

Lay the Boundary Wire (See Figs. 5-17)

Use the boundary wire to define the mower's working area. The boundary wire will also guide the mower to its base station.

NOTE: If your neighbour uses a robotic mower, keep a space of at least 1m between your boundary wire and your neighbour's.

After a few weeks the grass will have grown over the boundary wire making it invisible. Use the plier to pull out the pegs to release the boundary wire if you need to make adjustments to the boundary loop.

Planning where to lay the boundary wire

Before laying the boundary wire, walk along the edge of the lawn and plan where and how to set up the boundary wire. Take note of all obstacles and slopes if necessary.

NOTE:

- Use original boundary wire to form a loop around the working area. It is specially designed to be moisture-proof.
- The maximum permitted length for the boundary wire is 150m.

Laying the boundary wire

Follow the instructions listed as below to lay the boundary wire around the working area and around obstacles. Use the supplied measurement gauge to lay the boundary wire properly.

NOTE: The boundary wire must be laid anti-clockwise around the lawn.

NOTE: The boundary wire is powered with a very low voltage, and it is safe for humans and pets.

NOTE: Start at the rear of the base station to lay the boundary wire anti-clockwise around the lawn. End the boundary wire at the front of the base station, leaving enough wire to go underneath the base station to the terminal at the rear. Refer to section 5 "Connect and Install the Base Station" for more information.

- Secure the boundary wire to the ground with supplied wire pegs. Each peg should be placed around 50cm apart. Use the provided measurement gauge to ensure the proper distance. Keep the boundary wire straight and tight. There should be no slack wire between the pegs (Fig. 5).
- When laying the boundary wire, use the measurement gauge to keep a 30cm space between

ASSEMBLY

the boundary wire and the boundary (Fig. 6).

- If the lawn is bordered by a level surface (e.g. a path or driveway) that is level with the lawn, the boundary wire can be laid along the edge of the path or driveway, so that the mower can cut right over the edges. Make sure the width of the path or driveway must be more than 1m (Fig. 7).



WARNING

The mower must not run over gravel or similar material which can damage the blades.

- It is possible to let the boundary wire cross the working area if there is a small dip. Use a peg to secure the boundary wire into the ground, and make sure the wire is as close as possible to the ground. This ensures the blades of the mower never come in contact with the boundary wire (Fig. 8).

NOTE: Extra boundary wire should be cut off to avoid disrupting the robotic lawnmower. Extra wire must not be placed in coils outside the boundary wire (Fig. 9).

Smooth turns

Maintain at least 90° angle at all left-turn corners when laying the boundary wire along the boundary. Secure the boundary wire with pegs at every turning point.

Do not lay the boundary wire at sharp angles, or it will be difficult for the robotic lawnmower to follow the boundary wire (Fig. 10).

Slopes

The robotic mower has the ability to safely climb slopes of 35%, and areas that are steeper than this should be isolated with the boundary wire (Fig. 11).

To calculate the slope of your lawn, see Fig. 11. The slope would be:

$$\frac{35\text{cm (Elevation)}}{100\text{cm (Length)}} = 35\% \text{ (slope)}$$

Perimeter islands

If there are flower beds, ponds or small trees in the lawn, create perimeter islands to protect them. Lay the boundary wire clockwise around the obstacle to make sure the mower can work properly around it. Between the two parallel boundary wires, it should be less than 1cm wide (Fig. 12).



WARNING

The boundary wire must not be crossed on its way to and from an island (Fig. 13).

Where the distance between two islands is more than 1m, the boundary wire is suggested to be laid out as illustrated (Fig. 14).

ASSEMBLY

In the case that two islands are too close, the width between two islands no more than 1m, it is recommended to lay out the boundary wire as illustrated (Fig. 15).

How to wire a sub zone

If there are additional zones in your lawn:

- To allow the mower to drive through the narrow passage smoothly, the narrow passage that connects the main zone and sub zone should be at least 1m wide and at most 5m long (Fig. 16).
- Make sure the narrow passage is firm, level and smooth.
- If the narrow passage that connects two areas is too narrow for the robotic lawnmower to navigate, lay the boundary wire around the sub zone so that it forms an island outside of the main zone (Fig. 17). Carry the mower manually to the sub zone. The mower will mow until the battery runs out. Then take the mower back to the base station in the main zone for recharge.

Connect and Install the Base Station (See Figs. 18-22)

NOTE: Start at the base station's location to lay the boundary wire anti-clockwise around the lawn.

NOTE: The boundary wire must be laid and connected to the base station before securing the base station to the ground.

- Place the base station on the ground in the desired position. Follow the instructions in the "Select the Proper Base Station Location" section. Do not connect the base station to the mains or fix into place.
- Peg the starting end (①) of the boundary wire into place at position 1 as illustrated (close to the terminals at the rear of the base station), leaving 20cm length for connection later (Fig. 18).
- Install the boundary wire anti-clockwise around the lawn as described in the "Lay the Boundary Wire" section.
- Run the end (②) of the boundary wire through the slot under the base station, leaving 20cm length for connection later (Fig. 18).
- With the wire stripper provided, strip 10-15mm of insulation material from the ends of the boundary wire for connection to the base station (Fig. 19).
- Before connecting the boundary wire to the base station, ensure the base station power supply is disconnected from the mains.
- Insert the wire ends into terminals at the rear of the base station. Run the starting wire (①) through the hole (C) in the base station and connect it to the red terminal (A). The end of the wire (②) that runs under the base station connects to the black terminal (B). To insert the wire end into the terminal, press down on the tab of the terminal until the terminal hole is visible, fully insert the wire end into the corresponding terminal, and then release the tab to secure the wire end. Gently pull the wires once they are connected and make sure they are connected firmly into place. This is important to ensure correct signal of the boundary wire (Fig. 20).

ASSEMBLY

NOTE: Make sure the boundary wire is straight and tight between the hole (C) and terminal (A). Extra boundary wire should be cut off to avoid disrupting the robotic lawnmower (Fig. 20).

NOTE: The boundary wire should not be crossed when connecting to the base station. The starting end of the boundary wire must be connected to the OUT-wire terminal (red) and the end of the boundary wire to the IN-wire terminal (black).

- Attach the base station to the ground, and secure it with the supplied four screws (Fig. 21).
-

WARNING

Do not make new holes in the plate of the base station. Only use the existing holes in the base station to secure it to the ground.

WARNING

Do not tread or walk on the plate of the base station (Fig. 22).

Connect the Base Station to the Power Source (See Figs. 23-25)

- To connect the base station's power cord to the power adaptor, align the notch on the power cord (①) with the groove on the adaptor (②) and turn the locking sleeve (③) clockwise to lock into place (Fig. 23 & 24).
 - Position the power adaptor on the ground as shown to protect from water. Alternatively, to keep it away from standing water, the power adaptor can be wall mounted by screwing it to the wall through the holes provided (Fig. 25).
 - Connect the power adaptor to a 100-240V wall socket. If the power supply is connected to an electrical outlet outdoors, make sure the electrical outlet is always in a dry place and the wattage is compatible with the mower.
-

WARNING

Do not put the power cord in the working area defined by the boundary wire, or the mower may cut the power cord.

WARNING

Recharge the mower only with the base station specified by the manufacturer. Incorrect use may result in electric shock, overheating or leakage of corrosive liquid from the battery.

When the boundary wire and base station are connected successfully and the power adaptor is connected to an electrical outlet, the LED on the base station will turn on green continuously.

ASSEMBLY

Check the LED status as below to make sure the connection between the base station and boundary wire is OK.

| LED on the Base Station | Status | Action |
|-------------------------|---|---|
| Green, continuous | Boundary wire and base station are connected successfully; the robotic mower is fully charged. | / |
| Green, flashing | The robotic mower is charging. | / |
| Off | No power supply. | Check the power adaptor, cord, breakers, and fuses. |
| Red, flashing | Power adaptor is connected successfully, while the boundary wire is connected unsuccessfully to the base station. | Check the boundary wire for correct connection to the base station. |

NOTE: The boundary wire must be laid anti-clockwise around the lawn. If the boundary wire is laid clockwise around the lawn, the LED on the base station still be green continuous, but the mower is not able to work within the boundary area.

Splice the Boundary Wire (See Figs. 26-27)

Use a coupler to extend and splice the boundary wire as needed. The coupler is waterproof and provides optimal connection.

- Insert both wire ends in any two of the three holes of the coupler (Fig. 26).
- Verify that the wires are fully inserted and both wire ends are visible on the other side of the coupler (Fig. 26).
- Use a pair of pliers to press the coupler together (Fig. 27).

OPERATION

Switching On/Off

| Position | Status |
|----------|--------|
| I | on |
| O | off |

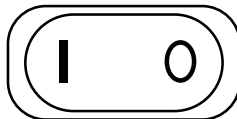

Control Panel (See Fig. 28)

① Signal Indicator

| Signal Indicator | Status |
|------------------|------------------------------------|
| Off | Signal of boundary wire is normal. |
| Red, Flashing | Signal lost. |

② Battery Indicator

| Battery Indicator | Status |
|-------------------------------------|--|
| Green, Continuous | Sufficient power for mowing/ fully charged. |
| Green, Flashing | Charging; battery capacity is more than 40%. |
| Yellow, Flashing | Charging; battery capacity is less than 40%. |
| Red, Continuous | Recharge required. |
| Red, Flashing | The temperature of battery pack is abnormal, or the electric core fault. |
| Green and Red, Alternately Flashing | The mower is on the base station while the On/Off switch is on the "O" OFF position. |

③ Error Indicator

| Error Indicator | Status |
|--------------------|---|
| Off | The mower is in normal operation. |
| Red, Continuous | Hardware issue. |
| Yellow, Flashing | The rain sensor is activated. |
| Yellow, Continuous | The lift sensor, drop sensor, boundary sensor, or bump sensor is activated. |

④ Time Setting Indicators

When a time setting is selected, the corresponding indicator will be green continuous.

⑤ Time Setting Buttons

Make sure the control panel is unlocked. Press the time setting button to set the working time. Then press the OK button.

The mower will start at the same time as the first working session, every day.

OPERATION

| Time Setting Button | Daily Working Schedule |
|---------------------|---|
| 4H | 4 hours of working time (mowing and charging included), and 20 hours on standby on the base station. |
| 6H | 6 hours of working time (mowing and charging included), and 18 hours on standby on the base station. |
| 8H | 8 hours of working time (mowing and charging included), and 16 hours on standby on the base station. |
| 10H | 10 hours of working time (mowing and charging included), and 14 hours on standby on the base station. |

⑥ UNLOCK Indicator

| UNLOCK Indicator | Status |
|-------------------|------------------------|
| Green, Continuous | The mower is unlocked. |
| Red, Flashing | The mower is locked. |

⑦ Start Button

Start mowing.

⑧ OK Button

Confirm any setting.

⑨ UNLOCK Button

Unlock/lock the mower.

⑩ HOME Button

Press the STOP button. Unlock the control panel. Press the HOME button.

The mower will follow the boundary wire and return to the charging station. The mower will restart automatically on the next scheduled working window.

Starting/Stopping the Mower (See Fig. 29)

The robotic lawnmower is capable of working on its own. The mower knows when it needs to return to its base station to charge. It can stop automatically when sensing a problem. When it bumps into something blocking its path, it knows to stop, draw back, and turn around. For this reason, it is important to level any deep holes or dips and to remove potential obstacles and debris from the lawn surface. The robotic lawnmower will also automatically stop its blade turning disc from rotating if it is lifted off the ground to prevent an accident.

OPERATION

WARNING

Read the safety instructions carefully before you start your robotic lawnmower.

WARNING

Keep your hands and feet away from the rotating blades. Never put your hands or feet close to or under the mower when the motor is running.

WARNING

Never use the robotic lawnmower when people, especially children, or pets, are in the cutting area.

- Put the robotic lawnmower in the working area defined by the boundary wire.
- Press the On/Off switch to the “I” ON position.
- Open the top hatch to reveal the control panel.
- To unlock the mower, press the UNLOCK button until you hear a beep sound, and then input the security code by pressing the corresponding time setting button of each digit (①). Press the OK button. The control panel is unlocked (Fig. 29).

NOTE: The default security code is 2323.

- To start the mower, unlock the mower and then immediately press the Start button. The robotic lawnmower will begin to mow. The default daily working schedule includes 8 hours of working time (mowing and charging included), and 16 hours on standby on the base station.
- When charging is required, the robotic lawnmower will follow the boundary wire to return to the base station. It takes around 40~45 minutes to be fully charged. Then the robotic mower will resume mowing. When the 8 hours of working time is over, it will return to the base station and remain on standby on the base station for the working schedule next day.
- To stop the mower manually during operation, press the STOP button.
- To turn off the mower, press the On/Off switch to the “O” OFF position.



NOTE: If the signal of the boundary has been lost for 25 minutes or the temperature of battery pack has been higher or lower than the threshold for 25 minutes, it will automatically enter sleep mode (all the lights on the robot will turn off). Press the On/Off switch to the “O” OFF position to turn off the mower. Then turn on the mower again.

NOTE: If the operating temperature is over 65°C, the battery indicator will flash red, and the robotic mower will follow the boundary wire to return to the base station. Allow the machine to cool down to reach a normal temperature. Then restart the mower, it will work again.

OPERATION

Working Time

The mower's default daily working schedule includes 8 hours of working time (mowing and charging included), and 16 hours on standby on the base station. The working schedule is illustrated as below.

The start time of the daily working schedule is the same time as when the mower was started for the first mowing. In the following days, the mower will start again at the same time for the selected working duration.

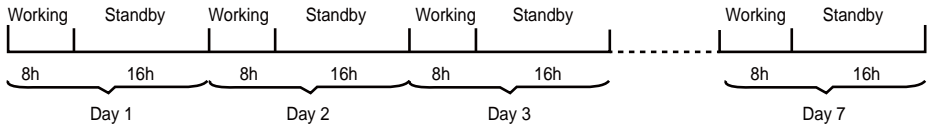

To change the working time:

Press the STOP button. Unlock the control panel. Press the time setting button to set the desired working time, and then press the OK button, you will hear two beeps.

Set schedule for “every other day”

If the lawn is small or you would like the mower to go out less often, it is possible to set it to cut every other day.

To do this:

Press the STOP button. Unlock the control panel (unlock button, enter PIN, press OK). Hold down the time setting button for at least 6s. Two beeps will sound and the time setting button will flash. Press the OK button, you will hear two beeps. The mower will now work on alternate days.

To change the start time:

At the time you wish the mower to begin mowing every day, press the On/Off switch to the “O” OFF position to turn off the mower. Then turn on the mower and restart it. The new start time is also set successfully.

NOTE: If the mower On/Off switch has been turned to the “O” Off position, the start time of the mowing window has been interrupted and must be re-set. Restart the mower using the switch at the desired start time.

OPERATION

Mowing the Edge (See Figs. 30-31)

Your robotic lawnmower is capable of following the boundary wire to mow the edge of your lawn.

For automatically mowing the edge:

After finishing two days' random working, the robotic mower will follow the boundary wire to cut the grass at beginning of the third day.

For manually mowing the edge:

Press the STOP button to stop the mower. Put the mower on the base station with its front facing towards to the base station (Fig. 30). Then unlock the mower and press the Start button to start it. The robotic lawnmower will move backwards, turn around and begin to follow the boundary wire to mow the edge (Fig. 31).

Locking the Mower with a Security Code

The mower will be locked automatically after 1 minute without any operation to prevent anyone from using the mower unless he/she has a valid code to enter. You will be prompted to enter a four digit number of your choice to use as your personal security code. This feature is to prevent operation of the mower by children or people who are unfamiliar with the mower or not permitted to use it.

NOTE: If the wrong code is entered, you will hear four beeps. Re-enter the correct security code.

NOTE: If you forget the security code, contact the after sales helpline.

For manually locking the mower:

Press the UNLOCK button until you hear a long beep sound. The UNLOCK indicator will be red flashing and the control panel is locked.

Changing the Security Code

The default security code is 2323.

To change the security code:

- Unlock the mower.
- Press the HOME button and Start button simultaneously for around 3 seconds until you hear a beep sound and all time setting indicators flash one time.
- Input the new security code and press the OK button. You will hear two beeps. The new security code is set successfully.

OPERATION

Setting the Cutting Height (See Fig. 32)

WARNING

Do not make any adjustment to the lawn mower without first stopping the motor. Keep your feet away from the blade turning disc when adjusting its height.

The cutting height of the mower can be adjusted from MIN (20 mm) to MAX (60 mm) (Fig. 32). During the first weeks after installation, always select the cutting height (40 mm) to avoid damaging the boundary wire. After this, the cutting height can be lowered step by step every week until the desired cutting height has been reached.

- Press the STOP button to stop the robotic lawnmower.
- Open the hatch.
- Turn the cutting height adjustment knob to set the cutting height.
 - Turn clockwise to raise the cutting height.
 - Turn anti-clockwise to lower the cutting height..
- For the first cut each season, a higher cutting setting should be selected. **USING A CUTTING HEIGHT THAT IS TOO LOW IN LONGER GRASS WILL USE MORE POWER AND REDUCE BATTERY RUN TIME.**
- Before you begin to mow, check to ensure that the blade is not blunt and that none of the fasteners are damaged. To prevent any imbalance, replace blunt and/or damaged blades. To carry out this check, first switch off the mower using the On/Off switch.

Rain Sensor (See Fig. 33)

The robotic mower is equipped with a rain sensor. When it rains, the rain sensor will be activated, and the error indicator will flash yellow. The mower will stop moving and follow the boundary wire to return to the base by itself.

When the rain sensor has been activated within the working time, it will remain on standby for the rest of the day and will go out to mow the next day as scheduled, provided the sensor is dry. If the mower has been set to mow on alternate days, it will wait until the next working day.

MAINTENANCE

WARNING

Always switch the product off before performing inspection, maintenance and cleaning work!

WARNING

If a part becomes worn or damaged, use recommended manufacture replacement parts. Use of any other parts may create a hazard or cause product damage.

WARNING

Always wear safety goggles or glasses with side shields during operation. If operation is dusty, it is advised to also wear a dust mask.

WARNING

Do not use any attachments or accessories not recommended by the manufacturer of this product. The use of attachments or accessories not recommended can result in serious personal injury.

General Maintenance

- Check the boundary wire and add pegs for adequate tightness to the ground.
- Periodically check all nuts and bolts for proper tightness to ensure safe operation of the mower.
- Remove any buildup of grass and leaves on or around the mower and base station. Wipe the mower clean with a dry cloth occasionally.
- Inspect the base station and clean it from mud and debris to allow proper docking.

Replacing the Mower Blade (See Figs. 34-35)

WARNING

Always wear protective, heavy gloves and/or wrap the cutting edges of the blade with rags when performing blade maintenance. Failure to heed this warning could result in serious personal injury.

Always check to see if the blades are in good condition. If the blades are blunt, damaged or showing signs of imbalance, they must be replaced. Only use recommended replacement blades. Make certain ALL 3 blades and screws are replaced at the same time to keep a balanced cutting system. Additional blades can be purchased from www.cleva-europe.com.

To replace the blades

- Press the STOP button and allow the blade to come to a complete stop.
 - Press the On/Off switch to the "O" OFF position.
-

MAINTENANCE

- Slowly turn the mower over. Place it on a soft and clean surface.
- Use a suitable tool (e.g., a screwdriver) to insert into one of three holes in the blade turning disc to fix the blade turning disc. This ensures the blade turning disc is not turning when replacing the blades to avoid personal injury.
- Wear protective gloves and remove all three screws and blades with a screwdriver (Fig. 34).
- Secure the new blades with new screws.
- Make sure all blades can spin freely.

Cleaning the Underside

It is recommended to check and clean the underside of the mower regularly.

- Press the STOP button and allow the blade to come to a complete stop.
- Press the On/Off switch to the "O" OFF position.

NOTE: If the mower On/Off switch has been turned to the "O" Off position, the start time of the mowing window has been interrupted and must be re-set. Restart the mower using the switch at the desired start time.

- Slowly turn the mower over. Place it on a soft and clean surface.
- Wash the underside of the mower with water. Clean it by using a regular garden hose if it is very dirty.

IMPORTANT: Do not wash the mower with a high-pressure washer!

- Wear safety gloves to clean the blade turning disc, the chassis, and the front and rear wheels thoroughly with a soft brush or damp cloth. Remove any lodged debris around them.
- Make sure the blade turning disc can rotate freely and all blades can spin freely.

Storing the Mower

It is recommended to store the mower indoors during the winter.

- To optimise the battery longevity, ensure the mower is fully charged before storage during winter.
- Turn the On/Off switch to the "O" OFF position.
- Clean the mower thoroughly.
- Use both hands to carry the mower at the front and rear sections under the mower. Carry the mower with the blade disc away from the body (Fig. 35).
- Store the mower indoors in a clean, dry place out of the reach of children.

IMPORTANT: Protect the underside of mower from standing water. NEVER store the mower upside down outdoors.

Storing the Base Station

If the base station is left outside for the winter, leave the boundary wire connected.

- Disconnect the power adaptor from the power outlet.
- The base station and the boundary wire can be left outside in the winter.
- It is recommended to place the base station in a dry and sheltered location.

MAINTENANCE

Updating the Software (See Fig. 36)

The software of the mower can be updated if necessary.

NOTE: Make sure the USB flash drive works normally and the On/Off switch is in the "I" ON position during updating.

NOTE: Make sure the battery indicator is green and the mower has sufficient power for updating the software.

- Download the robotic mower's latest software from our support website www.cleva-europe.com onto a USB flash drive device.

- Stop the mower and turn the On/Off switch to the "O" OFF position.

NOTE: If the mower On/Off switch has been turned to the "O" Off position, the start time of the mowing window has been interrupted and must be re-set. Restart the mower using the switch at the desired start time.

- Turn the mower upside-down. Wear protective gloves and remove all six screws with a screwdriver.

- Remove the battery cover. The USB port (①) is located on the bottom of the mower (Fig. 36).

- Turn the On/Off switch to the "I" ON position. After hearing two beeps insert the USB flash drive into the USB port, then you will hear four beeps. The software is updating when all four time setting indicators are flashing.

- After finishing the updating of the software, you will hear continuous beeping and the entire time setting indicator will be green continuous. Remove the USB flash drive. When you hear two beeps, the update is complete.

- Turn the On/Off switch to the "O" OFF position. Place the battery cover back to the mower and secured with six screws.

NOTE: If the mower On/Off switch has been turned to the "O" Off position, the start time of the mowing window has been interrupted and must be re-set. Restart the mower using the switch at the desired start time.

TROUBLESHOOTING

WARNING

Only perform the steps described within these instructions! All further inspection, maintenance and repair work must be performed by a qualified specialist.

Gloves and appropriate protective clothing must be worn when performing these instructions.

Always turn off the mower before making any adjustment. Parts can be purchased from www.cleva-europe.com.

| PROBLEM | POSSIBLE CAUSE | SOLUTION |
|---|---|--|
| The robotic lawnmower is stuck during mowing. | Grass or other debris is wrapped around the wheels. | Check wheels and remove the grass or objects. |
| | Grass or other debris is wrapped around the blade turning disc. | Check the blade turning disc and remove the grass or objects (always wear gardening gloves). |
| | The blade disc lies in a pool of water. | Move the robotic lawnmower and prevent the collection of water in the working area. |
| | The robotic lawnmower has got caught in something. | Free the mower and remove the obstacle. |
| | The robotic lawnmower is stuck behind a number of obstacles. | Check if there are any obstacles which make it hard for the robotic lawnmower to move on from this location. Remove the obstacles. |
| | The mower is stuck in an uneven dip or hollow in the lawn. | Ensure that dips and holes in the lawn are leveled with topsoil and over-seeded with grass seed. |
| | The lift sensor has been activated as the mower has become trapped. | Free the mower. |
| No boundary wire signal. | No power. | Make sure the power cord is connected properly to the power adaptor and the power adaptor is connected to a suitable power supply. Check the wall socket connection and whether an earth-fault breaker has tripped or not. |

TROUBLESHOOTING

| | | |
|--|--|---|
| | The boundary wire is not connected to the base station. | Check the boundary wire for proper connection to the base station. Refer to the Connect and Install the Base Station section on page 17. |
| | The boundary wire is damaged | Repair the damaged boundary wire section with spare wire. Refer to the Splicing the Boundary Wire section on page 19. Or buy new boundary wire from aftersales to replace the entire boundary wire. |
| | The boundary wire is broken. | Check the boundary wire and replace the damaged section with a new boundary wire using an original coupler. Available from www.cleva-europe.com . |
| | The boundary wire is crossed on its way to and from an island. | Make sure the boundary wire is laid properly. Refer to the Lay the Boundary Wire section on page 15-17. |
| | The signal is affected by metal objects (fences, reinforcement steel) or buried cables close by. | Adjust the boundary wire according to instructions. |
| | The connection between the robotic lawnmower and the base station has been broken. | Place the robotic lawnmower in the base station and generate a new loop signal. |
| The robotic lawnmower runs outside working area. | The boundary wire is laid clockwise around the lawn. | Make sure to start at the base station's location and lay the boundary wire anti-clockwise around the lawn. |
| | The boundary wire is crossed when connecting to the base station. | Check the boundary wire for proper connection to the base station. Refer to the Connect and Install the Base Station section on page 17. |
| | The boundary wire is too close to the edge of the working area. | Make sure the boundary wire is laid according to instructions. Refer to the Lay the Boundary Wire section on page 15-17. |
| | The working area is steeper than 35%. | |
| | The boundary wire is laid incorrectly around the obstacle. | |

TROUBLESHOOTING

| | | |
|---|---|--|
| | The signal is affected by metal objects (fences, reinforcement steel) or buried cables close by. | Adjust the boundary wire according to instructions. |
| | There are obstacles too close to the edge of the boundary wire. | |
| | The robotic lawnmower is affected by the signal from another robotic lawnmower installation close by. | |
| Empty battery. | The robotic lawnmower cannot find the base station. | Check the boundary wire for proper connection to the base station. |
| | The battery has a fault. | Contact the After Sales Helpline. |
| The robotic lawnmower has difficulty docking. | The base station is on a slope. | Place the base station on a surface that is entirely level. |
| | Poor connection caused by debris on the charging strips. | Clean the contact strip located on the base station and the charging strips on the mower using a cloth. |
| | Environmental influences. | Restart the mower. |
| The robotic lawnmower is stuck in the base station. | There is an object in the way of the robotic lawnmower preventing it from leaving the base station. | Remove the object. |
| The robotic lawnmower is upside down. | The robotic lawnmower is leaning too much or has turned over. | Turn the robotic lawnmower the right way up and rectify the reason for it getting turned over. |
| Collision sensor problem, front/rear. | Mower body cannot move freely around its chassis. | Check that the mower body can move freely around its chassis. If the problem remains, contact the After Sales Helpline. |
| Safety function faulty | Temporary electronic or software related issue in the mower. | Switch off the mower. Restart the mower. Download and install the latest software update from www.cleva-europe.com . If the problem remains, contact the After Sales Helpline. |
| Electronic problem | | |
| Charging system problem | | |
| Temporary problem | | |
| The robotic lawnmower runs to the base station, but the blade disc does not rotate. | The robotic lawnmower searches for the base station. | This is normal. The mower needs to recharge. The blade disc does not rotate while it is searching for the base station automatically. |

TROUBLESHOOTING

| | | |
|---|---|--|
| The robotic lawnmower vibrates. | Cutting blades are damaged. | Replace the blades. Refer to Replacing the Mower Blade section on page 26-27. Blades are available from www.cleva-europe.com . |
| | Too many blades in the same position lead to imbalance in the cutting system. | Check that only one blade is fitted at each screw. |
| | Different versions (thickness) of blades are used. | Check if the blades are of different versions (thickness). |
| | The blade screw is loose. | Tighten the blade screws. |
| Grass is being cut unevenly. | Working area is too big. | Adjust the boundary to decrease the size of the mowing area or add more working time. |
| | Blades are dull. | Replace all the blades and screws. Refer to Replacing the Mower Blade section on page 26-27. Blades are available from www.cleva-europe.com . |
| | Height of cut is too low. | Increase the height of cut. |
| | The blade turning disc is wrapped around by grass or other object. | Check underneath the mower and clear as necessary (always wear gardening gloves). |
| The charging time is much longer than 45 min. | The charging strips and contact strip are obstructed by debris. | Use a cloth to clean the contact strip located on the base station and the charging strips on the mower. |
| | Charging protector has activated due to high temperature. | Place the base station in a shady area or wait until the temperature has cooled down. |
| Mower does not charge. | No power. | Make sure the power cord is connected properly to the power adaptor and the power adaptor is connected to a suitable power supply. Check the wall socket connection and whether an earth-fault breaker has tripped or not. |
| | The charging strips and contact strip are contaminated. | Use a cloth to clean the contact strip located on the base station and the charging strips on the mower. |
| | The battery has a fault. | Contact the After Sales Helpline. |

TROUBLESHOOTING

| | | |
|---|---|--|
| | Socket outlet, fuse, mains cable or base station is defective. | Check the mains voltage and fuse, if necessary have the base station checked by qualified personnel. |
| Area of cut (battery duration) is not large enough. | Height of cut is too low, or the grass is too high. | Increase the height of cut. |
| | The grass is wet or damp. | Wait until the grass is dry. |
| | The grass is dense. | Increase the height of cut and add more working time. |
| The cutting blade is not rotating while the mower is switched on. | The cutting blade is obstructed. | Switch off the mower and clear obstruction (always wear gardening gloves). |
| | The blade screw is loose. | Tighten the blade screws. |
| LED on the base station does not turn on. | No power supply. | Check the power adaptor, cord, breakers, and fuses. |
| LED on the base station is flashing red. | Power adaptor is connected successfully, while the boundary wire is connected unsuccessfully to the base station. | Check the boundary wire for correct connection to the base station. |
| Error indicator is red continuous. | Lift sensor fault. | Switch off the mower. Restart the mower. If the problem remains, contact the After Sales Helpline. |
| | Drop sensor fault. | |
| | Boundary sensor fault. | |
| | Bump sensor fault. | |
| | STOP button fault. | |
| | Control panel fault. | |
| | Security self-test program fault. | |
| | Battery pack voltage is lower than critical voltage. | |
| | Left or right wheel motor fault. | |
| | Blade motor fault. | |

TROUBLESHOOTING

| | | |
|--|--|---|
| Error indicator is yellow continuous. | Loss of traction for over 7 minutes. | Unlock the mower and press the Start button to start it. |
| | The mower is tilted more than 70 °. | Free the mower. Then unlock the mower and press the Start button to start it. |
| | The mower is tilted more than 30 ° for more than 10 seconds. | |
| | The mower is lifted for more than 10 seconds. | |
| | The mower bumps for more than 10 seconds. | Free the mower and remove the obstacle. Then unlock the mower and press the Start button to start it. |
| The battery indicator is red flashing. | The temperature of battery pack is abnormal. | Allow the machine to cool down to reach a normal temperature. Then unlock the mower and press the Start button to start it. If the problem remains, contact the After Sales Helpline. |
| | Electric core fault. (The error indicator is red continuous at the same time.) | Switch off the mower. Restart the mower. If the problem remains, contact the After Sales Helpline. |

SPECIFICATIONS

DIMENSIONS

| | |
|-----------------------|---------|
| Length | 55.6 cm |
| Width | 34.6 cm |
| Height | 23.4 cm |
| Weight (With Battery) | 8.1 kg |

ELECTRICAL SYSTEM

| | |
|--|------------------------------|
| Battery Type | 20 V Max Lithium-Ion, 2.0 Ah |
| Power Supply | 100-240 V |
| Charger Current | 1.5 A |
| Power Cable Length | 10 m |
| Charging Period (Battery Fully Discharged) | 40~45 min |
| Boundary Wire Length | 150 m |
| Boundary Wire Frequency Range | 0-148.5 kHz |
| Boundary Wire Magnetic Field Strength | 60 dbuA/m |

NOISE EMISSIONS MEASURED IN THE ENVIRONMENT AS SOUND POWER

| | |
|---|----------|
| Sound Power Level (L_{WA}) Measured | 59 dB(A) |
| Noise Emissions Uncertainties K_{WA} | 3 dB(A) |
| Sound Power Level (L_{WA}) Guaranteed | 62 dB(A) |
| Sound Pressure Level (L_{PA}) at the Operator's Ear | 48 dB(A) |

The noise emission declarations conforms to EN 50636-2-107:2015

Noise emissions in the environment measured as sound power (L_{WA}) in conformity with EC directive 2000/14/EC. The guaranteed sound power level includes variation in production as well as variation from the test code with 1-3 dB(A).

Sound pressure noise uncertainties K_{PA} , 2-4 dB (A)

SPECIFICATIONS

MOWING

| | |
|---|--------------------------|
| Voltage | 18 V === |
| No Load Speed | 3400-3500 /min |
| Cutting System | 3 Pivoted Cutting Blades |
| Blade Motor Speed | 3500 rpm |
| Cutting Width | 18 cm |
| Cutting Height Adjustment | 20-60mm (5 Positions) |
| Narrowest Possible Passage | ≥1 m |
| Power Consumption during Cutting | 25 W±20 % |
| Maximum Slope for Boundary Wire | 17% |
| Maximum Slope for Cutting Area | 35% |
| Working Capacity (Depending on Product Specification) | < 500 m ² |
| Average Mowing Time | 60 min |

IP-CLASSIFICATION

| | |
|-------------------|------|
| Robotic Lawnmower | IPX5 |
| Base Station | IPX4 |
| Power Adaptor | IPX5 |

RECYCLING AND DISPOSAL



This marking indicates that this product should not be disposed with other household wastes throughout the EU. The machine must be delivered in rigid packaging to avoid damage during transportation. The packaging and the machine itself are manufactured from recyclable materials and should be disposed of accordingly.



This appliance contains Lithium-ion battery. Do not dispose of batteries in household waste, fire or water. Dispose of batteries in accordance with the local regulations where they will be recycled in an environmentally friendly manner.

Li-ion

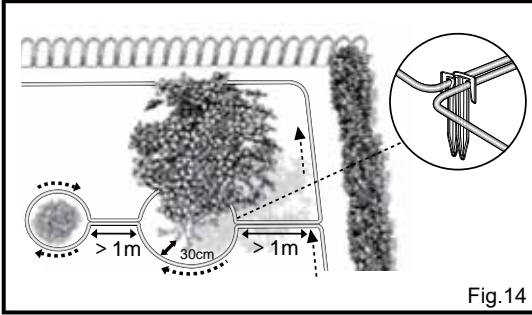

Fig.14

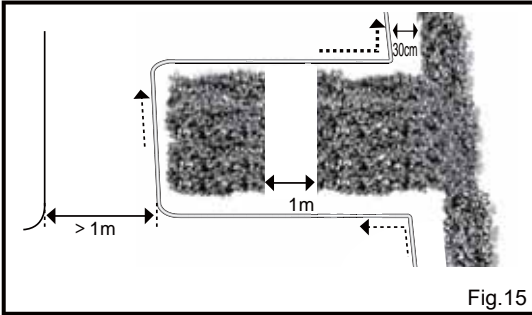

Fig.15

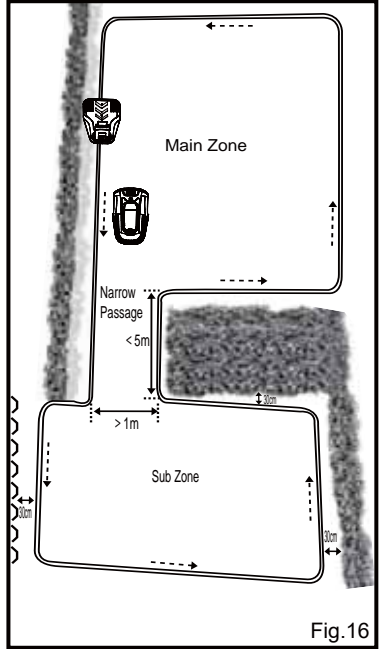

Fig.16

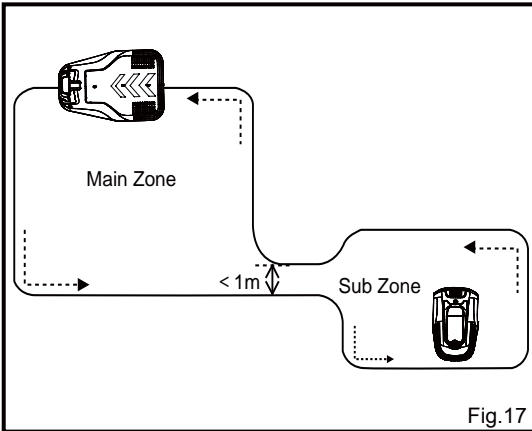

Fig.17

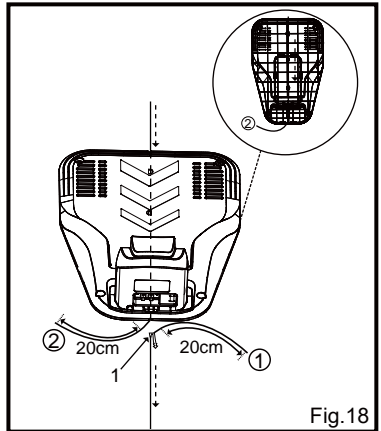

Fig.18

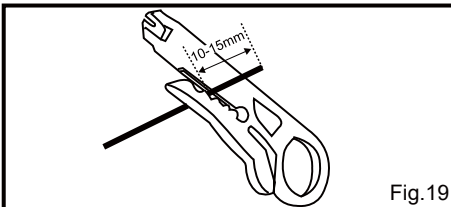

Fig.19

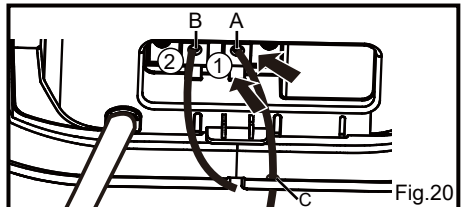

Fig.20

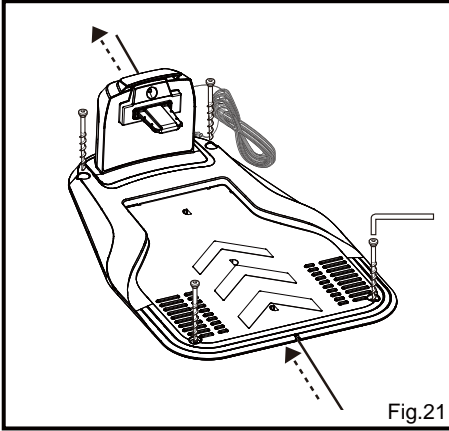

Fig. 21

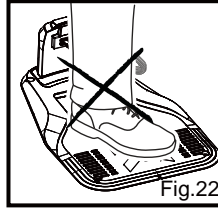

Fig. 22

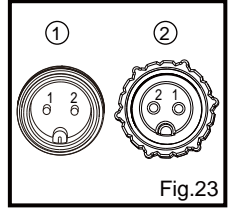

Fig. 23

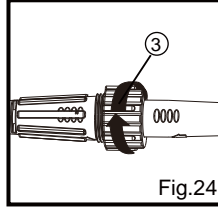

Fig. 24

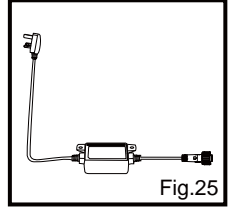

Fig. 25

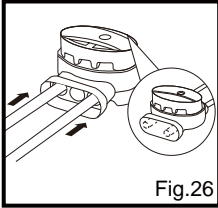

Fig. 26

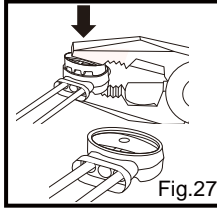

Fig. 27

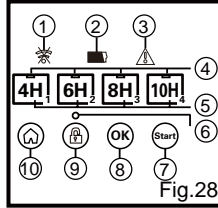

Fig. 28

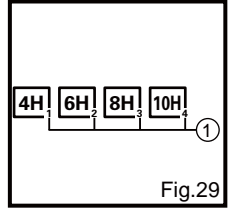

Fig. 29

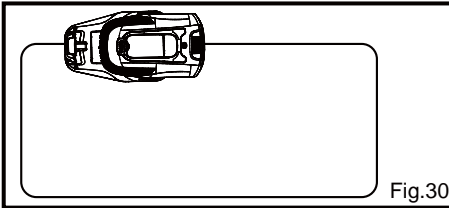

Fig. 30

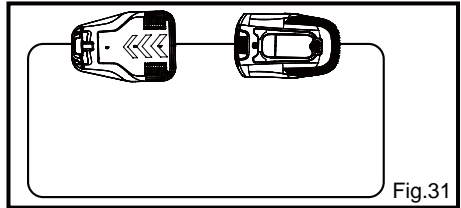

Fig. 31

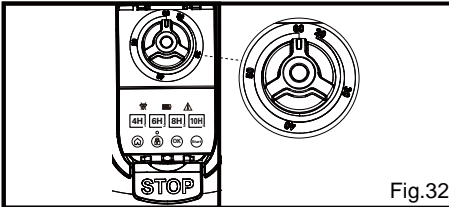

Fig. 32

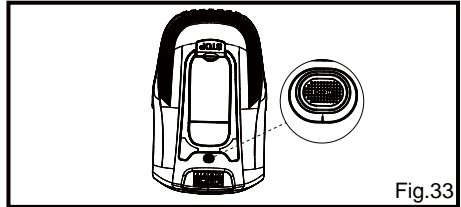

Fig. 33

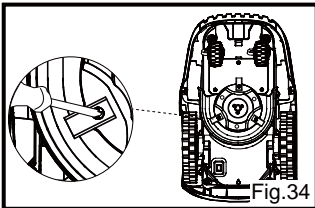

Fig. 34

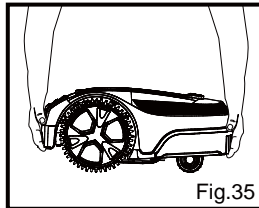

Fig. 35

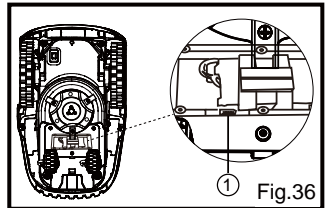

Fig. 36

L10

Suzhou Cleva Precision Machinery & Technology Co., Ltd.
No.18, Huahong Street, Suzhou Industrial Park,
215026 Suzhou P.R.China
www.cleva-europe.com