

# LawnMaster<sup>®</sup>

## Instruction Manual

LawnMaster 40cm 1800W Electric Mower MEB1840M



Original Instructions



**WARNING:** Read all safety instructions carefully before assembling and operating this machine. Ensure the machine has been assembled correctly and safely. Keep the instructions safe and pass them on to any subsequent user so that the information is always available.





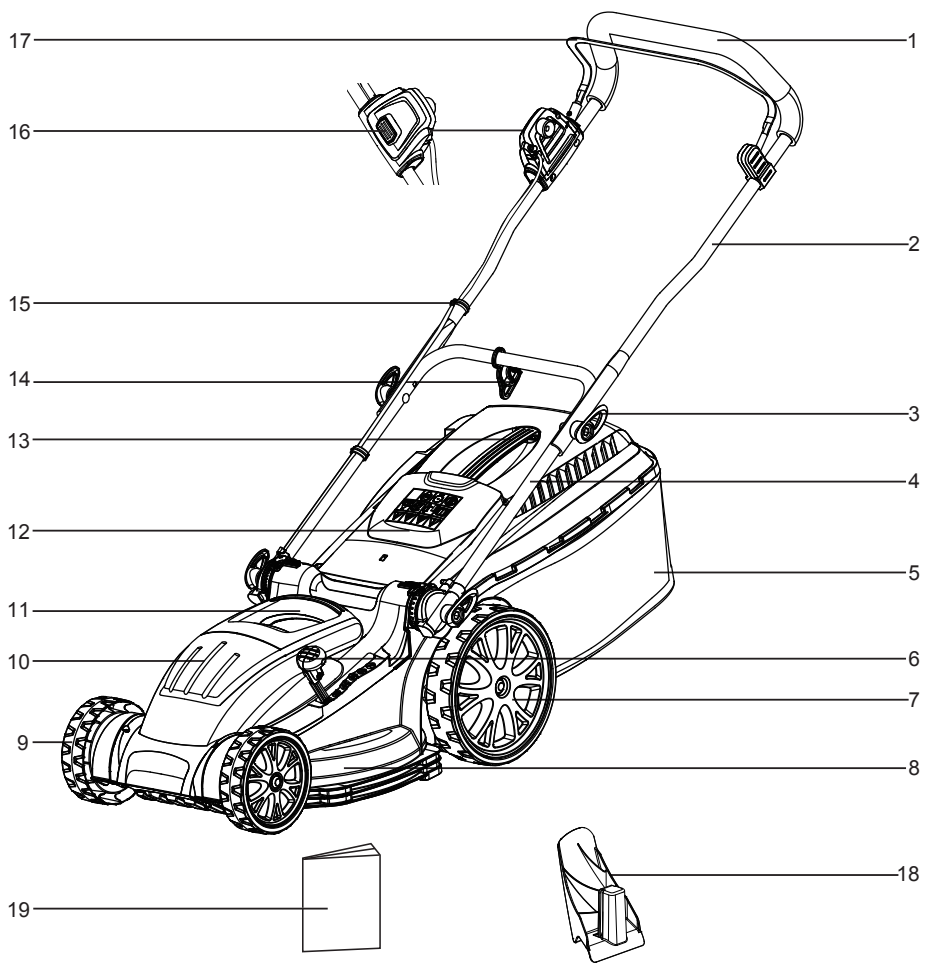















# TABLE OF CONTENTS

---

<b>Section</b>	<b>Page</b>
Symbols	5
Safety Information	6-13
In the Box	13
Assembly	14-16
Operation	17-19
Maintenance	20-21
Troubleshooting	22-23
Technical Data	24
Recycling and Disposal	24

# SYMBOLS

The following warning symbols appear throughout this manual and indicate the appropriate safety measures you should take when operating and maintaining the appliance.

SYMBOL	DESIGNATION/EXPLANATION
	Caution! Take extra care, beware of hazards.
	Read instruction manual.
	Do not expose the equipment to rain or leave outdoors. Do not work in the rain and do not cut wet grass.
	Risk of injury by objects thrown out of from the machine.
	Keep bystanders and pets at a safe distance while operating the mower.
	Caution! The lawnmower blade continues to run after switching off.
	Caution-sharp cutting blade! Keep feet and hands away. Risk of injury!
	Switch off the motor and disconnect the plug before carrying out maintenance or repair work, or if the power cable is caught or damaged.
	Wear eye and ear protection.
	Warning! Beware of electric shocks.
	Keep the power cable away from the cutting blade!
	Protection class II
	Noise level specification $L_{WA}$ in dB.
	Do not dispose of electrical equipment in domestic waste.
	Cutting diameter



## WARNING

To avoid serious personal injury, do not attempt to use this product until you read thoroughly and understand completely the instruction manual.

If you do not understand the warnings and instructions in the instruction manual, do not use this product.

## SAFETY INFORMATION

---



### IMPORTANT

**Read all safety regulations and instructions and keep in a safe place for future use.**

**Important!** When using equipment, the following safety precautions must be followed to avoid injuries and damage:

---

- Read all operating instructions carefully and comply with them. It is important to understand these instructions and to acquaint yourself with the machine, its correct usage and all safety requirements.
- Keep this manual in a safe place so that the information is available to the operator at all times.
- If you give the equipment to any other person, give them these operating instructions as well.
- We accept no liability for damage or accidents which result from non-compliance with these instructions.
- The device must not be used by people (including children) with limited physical, sensory or mental faculties or who lack the necessary experience and/or knowledge - other than they are supervised by a person responsible for safety or are being instructed to operate the appliance by such a person.
- Never allow children or people who are unfamiliar with these operating instructions to use the machine. Local regulations can restrict the age of the operator.
- Never operate the machine while people, especially children, or pets are nearby.
- Keep in mind that the operator or user is responsible for accidents or hazards occurring to other people or their property.

## SAFETY INFORMATION

---

- While operating the machine always wear substantial footwear and long trousers. Do not operate the machine when barefoot or wearing open toed sandals. Avoid wearing clothing that is loose fitting or that has hanging cords or ties.
- Thoroughly inspect the area where the machine is to be used and remove all objects which can be thrown by the machine.
- Before using, always visually inspect to see that the blade, blade bolt and the blade assembly are not worn or damaged. Replace worn or damaged components in sets to preserve balance. Replace damaged or unreadable labels.
- Before use check the power supply and extension cord for signs of damage or aging. If the cord becomes damaged during use, disconnect the cord from the supply immediately. **DO NOT TOUCH THE CORD BEFORE DISCONNECTING THE SUPPLY.** Do not use the machine if the cord is damaged or worn.
- Operate the machine only in daylight or in good artificial light.
- Avoid operating the machine in wet grass.
- Always be sure of your footing on slopes.
- Walk, never run.
- Mow across the face of slopes, never up and down.
- Exercise extreme caution when changing direction on slopes.
- Do not mow excessively steep slopes.
- Use extreme caution when reversing or pulling the machine towards you.

## SAFETY INFORMATION

---

- Stop the blade(s) if the machine has to be tilted for transportation when crossing surfaces other than grass, and when transporting the machine to and from the area to be used.
- Never operate the machine with defective guards or shields, or without safety devices, for example deflectors and/or grass collector, in place.
- Switch on the motor carefully according to instructions and with feet well away from the blade(s).
- Do not tilt the machine when switching on the motor, except if the machine has to be tilted for starting. In this case, do not tilt it more than absolutely necessary and lift only the part, which is away from the operator.
- Do not start the machine when standing in front of the discharge opening.
- Do not put hands or feet near or under rotating parts. Keep clear of the discharge opening at all times.
- Do not transport the machine while the power source is running.
- Stop the machine and remove plug from the socket. Make sure that all moving parts have come to a complete stop.
  - Whenever you leave the mower,
  - Before clearing blockages or unclogging chute,
  - Before checking, cleaning or working on the machine,
  - After striking a foreign object. Inspect the machine for damage and make repairs before restarting and operating the machine.
- If the machine starts to vibrate abnormally (check immediately)
  - Inspect for damage,



## SAFETY INFORMATION

---

- Replace or repair any damaged parts,
- Check for and tighten any loose parts.
- Keep all nuts, bolts and screws tight to be sure the machine is in safe working condition.
- Check the grass collector frequently for wear or deterioration.
- Be careful during adjustment of the machine to prevent entrapment of the fingers between moving blades and fixed parts of the machine.
- Always allow the machine to cool down before storing.
- When servicing the blades be aware that, even though the power source is switched off, the blades can still be moved.
- Replace worn or damaged parts for safety. Use only genuine replacement parts and accessories.
- The machine should be supplied via a residual current device (RCD) with a tripping current of not more than 30 mA.
- Ensure that the mains voltage matches the specifications on the rating plate.
- Use only authorised power cables of type H05VV-F, which are no more than 75 m long and suitable for outdoor use. The power cable wire cross section must be at least 2.5 mm<sup>2</sup>. Always completely unroll cable drums before use. Check the cable for damage.
- Keep the power cable away from the cutting tool when working. The cutting blades may damage the power cable and result in contact with live parts. Always run the power cable behind the operator. The extension cable can be accidentally cut. Risk of electric shock!
- Do not use the power cable to pull the plug from the socket. Protect the power cable from heat, oil and sharp edges.

## SAFETY INFORMATION

---

- Switch off the equipment and disconnect the plug from the socket if the power cable is damaged. If the power cable is damaged, it must be replaced by the manufacturer, the customer services of the same, or a qualified person, in order to avoid hazards.
- Do not connect a damaged power cable to the mains. Do not touch a damaged power cable when it is connected to the mains. A damaged power cable may result in contact with live parts.
- Do not attempt to repair the equipment yourself unless you have been trained to do so. Any work not specified in these instructions is to be carried out only by a qualified person.
- Use only spare parts and accessories supplied and recommended by the manufacturer. The use of non-original parts will immediately invalidate the guarantee.
- Before each use, carry out a visual inspection of the equipment. Do not use the equipment if protective devices (e.g. grass collection bag), parts of the cutting device or bolts are missing, worn or damaged. To avoid imbalance, damaged tools and bolts are to be replaced only in sets.
- Do not work with the equipment when tired, lacking concentration or under the influence of alcohol or drugs. Always take breaks in good time. Take a sensible approach to the work. A moment of carelessness when using the equipment can result in serious injury.
- Do not overload the equipment. Work only within the specified power range and do not change the regulator settings on the motor. Do not use low-powered machines for heavy work. Do not use your equipment for purposes other than those for which it is designed.

## **SAFETY INFORMATION**

---

- Do not work with equipment that is damaged, incomplete, or has been modified without the authorisation of the manufacturer. Do not use the equipment with damaged safety devices or screens or with missing safety equipment such as deflection and/or grass collection devices.
- Do not lift or carry the equipment when the motor is running. Risk of injury from cuts.
- Do not use the equipment near inflammable liquids or gases. Non-observance will result in a risk of fire or explosion.
- Keep the equipment in a dry location and out of reach of children.
- Always keep the grass ejection hole clean and clear. Remove cut material only when the equipment is stopped and disconnected from power supply.
- Do not leave the equipment unattended in the workplace.
- When servicing the blades, remember that they can move even if the power source is off.
- Handle the equipment with care. Keep tools sharp and clean, in order to facilitate better and safer work. Follow the maintenance instructions.

### **Double Insulation**

Double insulation is a concept in safety in electric power tools, which eliminates the need for the usual three-wire grounded power cord.

All exposed metal parts are isolated from the internal metal motor components with protecting insulation. Double insulated tools do not need to be grounded.

## SAFETY INFORMATION

---



### WARNING

The double insulated system is intended to protect the user from shock resulting from a break in the tool's internal insulation. Observe all normal safety precautions to avoid electrical shock.

---

**NOTE:** Servicing of a product with double insulation requires extreme care and knowledge of the system and should be performed only by a qualified technician.

### Electrical Connection

This product has a precision-built electric motor. It should be connected to a power supply that is 220-240V~50 Hz, AC only (normal household current). Do not operate this product on direct current (DC). A substantial voltage drop will cause a loss of power and the motor will overheat. If the product does not operate when plugged into an outlet, double-check the power supply.

### Extension Cords

When using a power tool at a considerable distance from a power source, be sure to use an extension cord that has the capacity to handle the current the product will draw. An undersized cord will cause a drop in line voltage, resulting in overheating and loss of power.

Before you connect the mower to the mains supply make sure that data on the rating plate are identical to the mains data. Before using any extension cord, inspect it for loose or exposed wires and cut or worn insulation.

# SAFETY INFORMATION

---



## WARNING

Keep the extension cord clear of the working area. Position the cord so that it will not get caught on other obstructions while you are working. Failure to do so can result in serious personal injury.

---

### Intended Use

This lawnmower is designed for domestic use only:

- This electric lawnmower is intended for mowing lawns in domestic and hobby gardens.
- This product is not to be used in wet weather conditions and may not be used to mow wet or unusually high grass.
- This product is intended for private domestic use only, not for any commercial trade use. It must not be used for any purposes other than those described. Any use of the machine that deviates from its intended use will invalidate the warranty.

### IN THE BOX

---

- |                                    |                                 |                             |
|------------------------------------|---------------------------------|-----------------------------|
| 1. Foam Grip                       | 8. Deck                         | 15. Cable Clip (x2)         |
| 2. Upper Handle                    | 9. Front Wheel                  | 16. Safety Button           |
| 3. Wing Knob (x4)                  | 10. Motor Housing               | 17. Start/Stop Switch Lever |
| 4. Lower Handle                    | 11. Carry Handle                | 18. Mulching Plug           |
| 5. Grass Collection Bag            | 12. Deflector Guard             | 19. Instruction Manual      |
| 6. Cutting Height Adjustment Lever | 13. Grass Collection Bag Handle |                             |
| 7. Rear Wheel                      | 14. Cord Retainer               |                             |

# ASSEMBLY

---

## Assembly Preparation

- Carefully remove all contents from the product packaging.
  - Ensure you have all the accessories and tool(s) needed for assembly and operation. This also includes suitable personal protective equipment.
- 



## WARNING

If any parts are damaged or missing do not operate this product until the parts are replaced. Failure to pay attention to this warning could result in serious personal injury.



## WARNING

Do not attempt to modify this product or create accessories not recommended for use with this product. Any such alteration or modification is misuse and could result in a hazardous condition leading to possible serious personal injury.



## WARNING

Do not connect to power supply until assembly is complete. Failure to comply could result in accidental starting and possible serious personal injury.



## WARNING

Never operate the mower without the proper safety devices in place and in correct working order. Never operate the mower with damaged safety devices. Failure to pay attention to this warning can result in serious personal injury. Make sure all packing is removed from product parts before starting assembly.

---

## Assembling the Lower Handle (See Fig. 1)

- Unfold the lower handle and adjust to the desired operating position. There are three possible positions (Fig. 1).
- Rotate the wing knobs clockwise to tighten (Fig. 1).

## Assembling the Upper Handle (See Fig. 2)

- Align the upper handle and lower handle and secure with the wing knobs and bolts (Fig. 2).
- There are two possible height positions. Choose the one most suitable to the operator's height.
- Secure the control cable against the handle frame with the supplied cable clips.

# ASSEMBLY

---

## Assembling the Grass Collection Bag (See Fig. 3)

- Fully insert the rods of the metal frame into the slots on either side of the plastic base of the grass collection bag. Secure the metal support rods into the fixing position on either side of the grass collection base. Ensure the side clamping sleeves are properly fixed onto the metal support frame (Fig. 3).
- There is a hole in the bottom of the grass collection bag to hang it up if required.

## Attaching/Removing the Grass Collection Bag (See Fig. 4)

**NOTE:** When using the grass collection bag, do not install the mulching plug. The mulching plug **MUST** be removed prior to installing the collection bag. The mulching plug is supplied fitted in the collection chute of the mower.

- Lift the deflector guard all the way up with one hand (Fig. 4).
- Attach the grass collection bag onto the mounting brackets provided at the back of the lawn mower. Align the bottom of the grass collection bag first ensuring the collection tongue is located fully within the discharge chute of the lawnmower (Fig. 4).
- Lower the deflector guard onto the grass collection bag - it will keep it in place.
- To remove the grass collection bag, lift the deflector guard and unhook the grass collection bag from the mounting brackets. Carefully release the deflector guard back down.

## Grass Collection Full Indicator (See Figs. 5-6)

The grass collection full indicator is a small flap located on the side of the grass collection bag.

- If the grass collection bag is empty or partially full, the grass full indicator flap will remain open (Fig. 5).
- When this flap remains closed it means that the grass collection bag is full and needs to be emptied (Fig. 6).

## Attaching/Removing the Mulching Plug (See Fig. 7)

---



# WARNING

Do not at any time make any adjustment to the lawnmower without first stopping the motor and disconnecting from power supply. Failure to comply could result in accidental starting and possible serious personal injury.

---

**NOTE:** The mulching plug **MUST** be removed if collection bag is used during mowing operation.

This mulching plug prevents grass from being collected by blocking the collection chute. This allows the grass clippings to be deposited back on the lawn during cutting. This finely cut grass acts as a nutrient for the lawn.

---

## ASSEMBLY

---

### To install the mulching plug:

- Lift the deflector guard and detach the grass collection bag.
- Lift and hold the deflector guard up with one hand.
- With other hand grasp the mulching plug by its upright handle and insert the plug into the rear discharge chute. Ensure that the locking latch snaps into place (Fig. 7).
- Release the deflector guard back into position during operation.

### To remove the mulching plug:

- Lift and hold the deflector guard up with one hand.
- With other hand squeeze the mulching plug's upright handle to release the locking latch. Pull the mulching plug up and out of the discharge chute.



## OPERATION

---

### **WARNING**

Do not allow familiarity with this type of product to make you careless. Always pay attention when operating this product, not doing so can result in serious injury.

### **WARNING**

Always wear safety goggles or safety glasses with side shields when operating this product. Failure to do so could result in objects being thrown into your eyes, resulting in possible serious injury.

### **WARNING**

Do not use any attachments or accessories not recommended by the manufacturer of this product. The use of attachments or accessories not recommended can result in serious personal injury.

---

### Setting the Cutting Height (See Fig. 8)

---

### **WARNING**

Switch off the equipment, disconnect the plug from the power supply and wait for the blade to come to a complete stop before adjusting the cutting height. A rotating blade can cause injury. Keep your feet away from the deck when adjusting its height.

---

Before using the mower for the first time, adjust the cutting position to the height best suited for your lawn. The mower can be set to 6 cutting heights between 20mm and 70mm. Choose the appropriate cutting height according to the types and conditions of the grass. For the first cut each season, a higher cutting setting should be selected.

Position	Cutting Height
1	20mm
2	30mm
3	40mm
4	50mm
5	60mm
6	70mm

# OPERATION

---

## To set the cutting height:

- To raise the cutting height, grasp the cutting height adjustment lever, disengage the lever from its current setting, and then move it towards the back of the mower and engage the lever in the desired cutting height position (Fig. 8).
- To lower the cutting height, grasp the cutting height adjustment lever, disengage the lever from its current setting, and then move it towards the front of the mower and engage the lever in the desired cutting height position (Fig. 8).

## Starting/Stopping the Mower (See Figs. 9-10)

- Make a loop in the power cord and hang the loop onto the cord retainer (Fig. 9).
- Connect the machine to a suitable power supply.
- Before switching the mower on, make sure that the working area is free from debris and foreign objects.
- Press and hold the safety button. Pull the switch lever towards the mower handle and hold in position (Fig. 10).
- Once started, release the safety button. Continue to hold the switch lever against the mower handle as you mow.
- To switch the mower off, release the switch lever.

**NOTE:** A high-pitched noise and sparking may occur as the electric motor decelerates. This is normal.

---



## WARNING

The blade may keep rotating for a few seconds after the device has been switched off. Do not touch the rotating blade. A rotating blade can cause injury.

---

## General Operation

Check the product, its power cord and accessories for damage before each use. Before use, ensure all power connections are in good working order prior to operation. If damage is present or observed, stop and have mower serviced before use. Do not use the product if it is damaged.

- Double check that the blade is properly installed.
  - Always hold the product by its handles. Keep the handle dry to ensure safe support.
  - Ensure that the air vents are always unobstructed and clear. Clean them if necessary with a soft brush. Blocked air vents may lead to overheating and damage the product.
  - Switch the product off immediately if you are disturbed while working by other people entering the working area.
  - Always let the product come to complete stop before removing the grass collection bag/mulching plug.
-

# OPERATION

---

- Always keep the power cord behind you and when you turn, move it to the side that has already been mowed.
- Do not overwork yourself. Take regular breaks to ensure you can concentrate on the work and have full control over the product.

## Mowing (See Fig. 11)

- Avoid cutting the power cord. It is advised to mow away from the plug socket and avoid twisting the power cord (Fig. 11). Mow at a normal walking pace and always overlap tracks by a few centimetres for a gap-free finish.
- Make sure the lawn is clear of stones, sticks, wires, and other objects that could damage the lawn mower blades or motor. Such objects could be accidentally thrown by the mower in any direction and cause serious personal injury to the operator and others.
- To reduce the likelihood of disconnecting the lawn mower from the power cord, be sure to use the cord retainer provided.
- When cutting thick grass, reduce walking speed in order to allow for a more effective cut and a proper discharge of the clippings.
- Never cut off more than one-third of the total length of the grass for a healthy lawn. If it is roughly 6cm long, the grass should not be shorter than 4cm once mowed. If the grass is higher, you should gradually cut it down to the desired length so as not to damage the grass. Cutting grass that is too long will result in poor collection performance and may overload the motor.
- Do not cut wet grass because it tends to stick to the underbody of the lawn mower, preventing the proper discharge of grass clippings resulting in poor collection performance.
- Slopes are a major factor related to slip and fall accidents that can result in severe injury. Mowing on slopes requires extra caution. If you feel uneasy on a slope, do not mow it. For your safety, do not attempt to mow slopes greater than 15 degrees.
- Mow across the face of slopes, not up and down. Exercise extreme caution when changing direction on slopes.
- Watch for holes, ruts, rocks, hidden objects, or bumps which can cause you to slip or trip. Tall grass can hide obstacles. Remove all objects such as rocks, tree limbs, etc., which could be tripped over or thrown by the blade.
- Always be sure of your footing. A slip and fall can cause serious personal injury. If you feel you are losing your balance, release the switch lever immediately.
- Do not mow near drop-offs, ditches, or embankments; you could lose your footing or balance.
- The mower is equipped with a rear roller, which leaves a striped finish on the lawn and helps to prevent scalping on borders and edges.

# MAINTENANCE

---



## WARNING

If a part become worn or damaged, use recommended manufacturers replacement parts. Use of any other parts may create a hazard or cause product damage.



## WARNING

Switch off the equipment before all maintenance and cleaning work, disconnect the plug and wait until the blade stops.



## WARNING

Do not use any attachments or accessories not recommended by the manufacturer of this product. The use of attachments or accessories not recommended can result in serious personal injury.

---

### General Maintenance

- Keep all safety devices, air vents and the motor housing free of dirt and dust. Avoid using solvents when cleaning plastic parts. Most plastics are susceptible to damage from various types of commercial solvents and may be damaged by their use. Use clean, dry cloths to remove dirt, dust, oil, grease, etc.
- Periodically check all nuts and bolts for proper tightness to ensure safe operation of the mower.
- Remove any buildup of grass and leaves on or around the motor cover. Wipe the mower clean with a dry cloth occasionally. Do not use water as this may damage any electrical components.

### Replacing the Mower Blade (*See Fig. 12*)

---



## WARNING

Always wear protective, heavy gloves and/or wrap the cutting edges of the blade with rags when performing blade maintenance. Failure to pay attention to this warning could result in serious personal injury.

---

- Stop the motor and disconnect the power supply. Allow the blade to come to a complete stop.
  - Turn the mower on its side.
  - Wear sturdy gloves and hold the blade firmly. Turn the blade screw anticlockwise off the motor spindle using a suitable wrench and remove it together with the blade (Fig. 12).
  - Replace the blade with a new one of the same type.
  - Reattach the blade onto the spindle, ensuring the blade's wings are angled upwards towards the mower deck. Ensure that the blade is positioned correctly and the screw tightened firmly.
  - Using a torque wrench, tighten the blade nuts to 20Nm max. to ensure the bolt is properly tightened.
-

# MAINTENANCE

---

## Storing the Mower (See Fig. 13)

The device features the following storage options to save space:

- Before storing your mower, ensure the product is disconnected from the power supply.
- Release the upper and lower wing knobs on both sides of the handle bars.
- Fold the upper handle and lower handle assembly over the device housing. Making sure that the cables do not become trapped (Fig. 13).
- The cable can be wrapped around the wing knobs for storage.
- Store the equipment in a cool, dry location and out of reach of children.
- Allow the motor to cool before storing the equipment in a confined space.
- Do not cover the equipment as moisture could build up.

## TROUBLESHOOTING

### **WARNING**

Only perform the steps described within these instructions! All further inspection, maintenance and repair work must be performed by a qualified specialist.

Gloves and appropriate protective clothing must be worn when performing these instructions.

Always turn off the machine and disconnect the plug and wait until the blade stops before making any adjustment.

PROBLEM	POSSIBLE CAUSE	SOLUTION
Handles are not in position.	The carriage bolts are not seated properly.	Adjust the height of the handle and make sure the carriage bolts are seated properly.
	The wing knobs are not tightened.	Tighten the wing knobs by rotating clockwise.
The mower does not start.	The power is off.	Check the socket, fuse, cable, wire and plug and have any repairs carried out by a qualified electrician.
	The power cord is not connected to power source.	Connect the power cord to a power source.
	Tripped circuit breaker in the house.	Reset house circuit breaker. If it trips again, call a qualified electrician.
	Defective switch lever or safety button.	Repair by a qualified person.
	The grass is too long.	Set a higher cutting height.
	Jammed blade.	Stop the mower and disconnect from the power supply, then remove the blockage.
The motor stops.	The mower is blocked by foreign object.	Remove the foreign object.
	Motor protection has engaged due to overheating.	Allow the mower to cool down. Cut long grass down in stages and avoid overloading the motor.

# TROUBLESHOOTING

The mower cuts grass unevenly or motor labours.	The lawn is rough or uneven or cutting height not set properly.	Adjust the cutting position to the height best suited for your lawn.
	The blade is blunt.	Replace the blade.
	The blade area is blocked.	Clean the blade area and remove the blockage.
	The blade is assembled incorrectly.	Install the blade correctly. Blade wings should be facing up away from the ground.
Poor collection performance.	The mowing conditions are not optimal.	Cut long grass down in stages by gradually lowering the height of cut. Wait for wet grass to dry.
	Mulching plug is inside collection chute.	Remove mulching plug.
The blade fails to rotate.	The blade is blocked by grass.	Remove the grass.
	The blade screw is loose.	Tighten the blade screw.
The mower vibrates at higher speed.	The blade screw is loose.	Tighten the blade screw.
	The blade is damaged.	Replace the blade.
	The motor shaft is bent.	Stop the motor, disconnect the power source, and inspect for damage. Have repaired made by a qualified personal.

## TECHNICAL DATA

Voltage	220-240V ~ 50Hz
Power	1800W
No Load Speed	3500/min
Cutting Width	40cm
Cutting Height Adjustment	20/30/40/50/60/70mm (6 Positions)
Grass Collection Bag Capacity	40L
Wheel Size	170/255mm
Weight	15.01kg
Protection Type	IPX4
Noise Level Specification ( $L_{WA}$ ) Guaranteed	96dB(A)
Vibration ( $a_n$ )	$3.6m/s^2$ $K=1.8m/s^2$
Protection Class	 / II

## RECYCLING AND DISPOSAL



This marking indicates that this product should not be disposed with other household wastes. The machine must be delivered in rigid packaging to avoid damage during transportation. The packaging and the machine itself are manufactured from recyclable materials and should be disposed of accordingly.





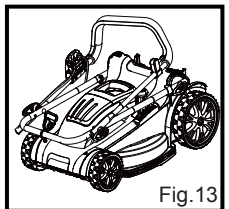
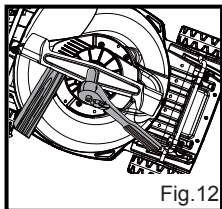
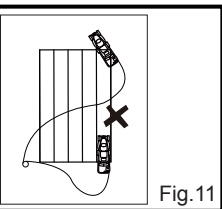
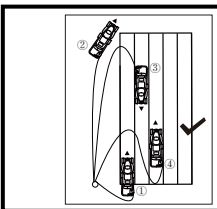
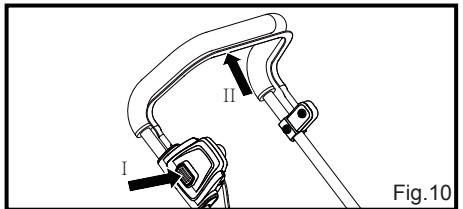
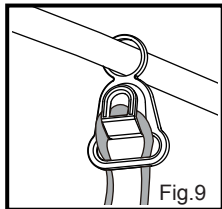
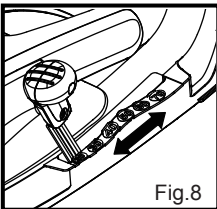
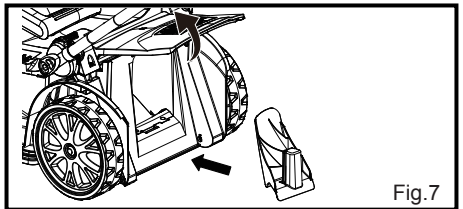
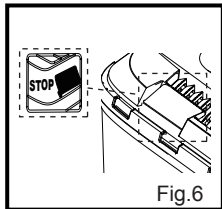
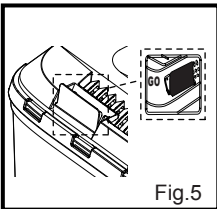
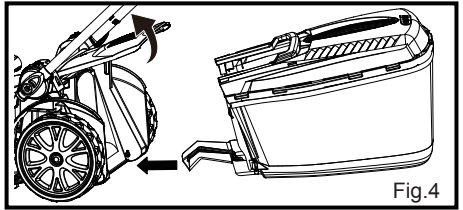
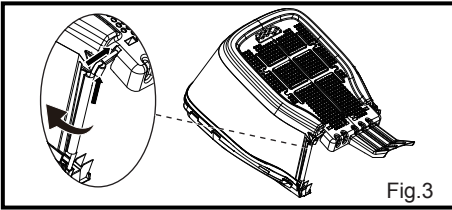
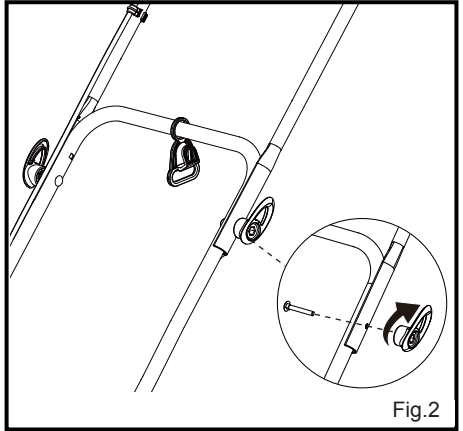
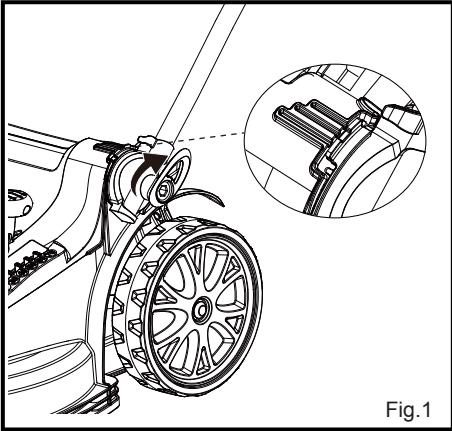



MEB1840M  
Suzhou Cleva Electric Appliance Co., Ltd.  
No.8 Ting Rong Street  
Suzhou Industrial Park, Suzhou  
Jiangsu Province, China  
[www.cleva-europe.com](http://www.cleva-europe.com)  
Made in P.R.C