

LawnMaster®

Instruction Manual

LawnMaster 33cm 1500W Electric Hover Mower MEH1533

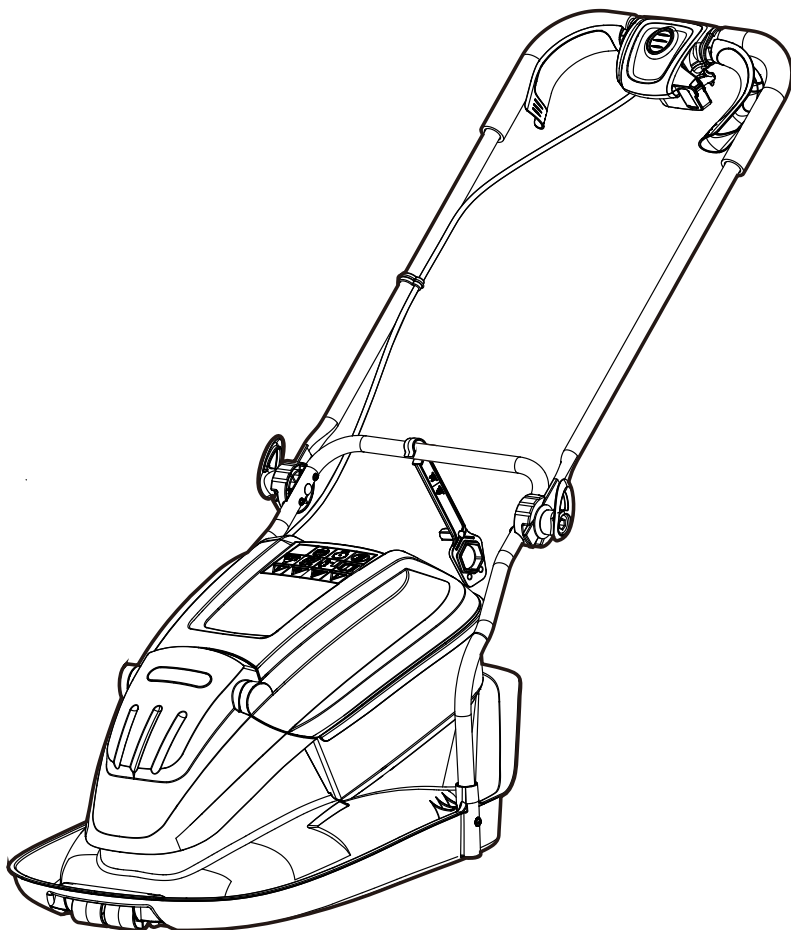

Original Instructions



WARNING: Read all safety instructions carefully before assembling and operating this machine. Ensure the machine has been assembled correctly and safely. Keep the instructions safe and pass them on to any subsequent user so that the information is always available.



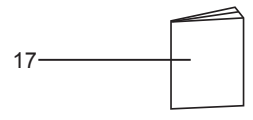
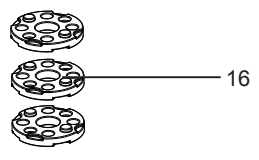
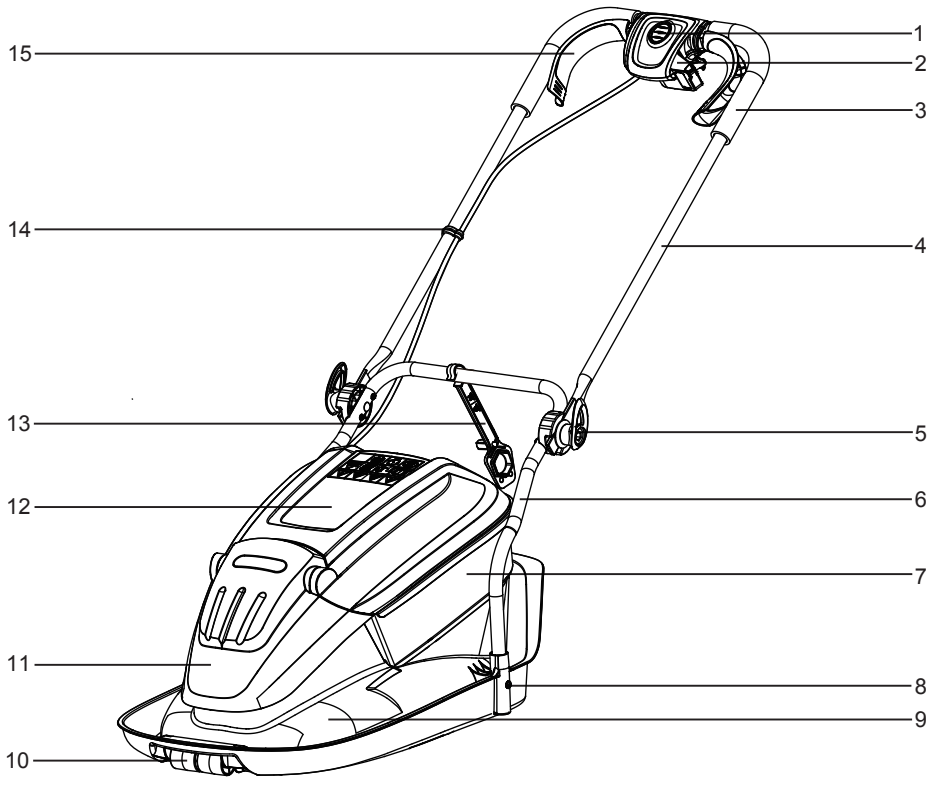

















TABLE OF CONTENTS

Section	Page
Symbols	5
Safety Information	6-13
In the Box	13
Assembly	14
Operation	15-18
Maintenance	19-20
Troubleshooting	21-22
Technical Data	22
Recycling and Disposal	22

SYMBOLS

The following warning symbols appear throughout this manual and indicate the appropriate safety measures you should take when operating and maintaining the appliance.

SYMBOL	DESIGNATION/EXPLANATION
	Caution! Take extra care, beware of hazards.
	Read instruction manual.
	Do not expose the equipment to rain or leave outdoors. Do not work in the rain and do not cut wet grass.
	Risk of injury by objects thrown out of from the machine.
	Keep bystanders and pets at a safe distance while operating the mower.
	Caution! The lawnmower blade continues to run after switching off.
	Caution-sharp cutting blade! Keep feet and hands away. Risk of injury!
	Switch off the motor and disconnect the plug before carrying out maintenance or repair work, or if the power cable is caught or damaged.
	Wear eye and ear protection.
	Warning! Beware of electric shocks.
	Keep the power cable away from the cutting blade!
	Protection class II
	Noise level specification L_{WA} in dB.
	Do not dispose of electrical equipment in domestic waste.
	Cutting diameter



WARNING

To avoid serious personal injury, do not attempt to use this product until you read thoroughly and understand completely the instruction manual.

If you do not understand the warnings and instructions in the instruction manual, do not use this product.

SAFETY INFORMATION



IMPORTANT

Read all safety regulations and instructions and keep in a safe place for future use.

Important! When using equipment, the following safety precautions must be followed to avoid injuries and damage:

- Read all operating instructions carefully and comply with them. It is important to understand these instructions and to acquaint yourself with the machine, its correct usage and all safety requirements.
- Keep this manual in a safe place so that the information is available to the operator at all times.
- If you give the equipment to any other person, give them these operating instructions as well.
- We accept no liability for damage or accidents which result from non-compliance with these instructions.
- The device must not be used by people (including children) with limited physical, sensory or mental faculties or who lack the necessary experience and/or knowledge - other than they are supervised by a person responsible for safety or are being instructed to operate the appliance by such a person.
- Never allow children or people who are unfamiliar with these operating instructions to use the machine. Local regulations can restrict the age of the operator.
- Never operate the machine while people, especially children, or pets are nearby.
- Keep in mind that the operator or user is responsible for accidents or hazards occurring to other people or their property.

SAFETY INFORMATION

- While operating the machine always wear substantial footwear and long trousers. Do not operate the machine when barefoot or wearing open toed sandals. Avoid wearing clothing that is loose fitting or that has hanging cords or ties.
- Thoroughly inspect the area where the machine is to be used and remove all objects which can be thrown by the machine.
- Before using, always visually inspect to see that the blade, blade bolt and the blade assembly are not worn or damaged. Replace worn or damaged components in sets to preserve balance. Replace damaged or unreadable labels.
- Before use check the power supply and extension cord for signs of damage or aging. If the cord becomes damaged during use, disconnect the cord from the supply immediately. **DO NOT TOUCH THE CORD BEFORE DISCONNECTING THE SUPPLY.** Do not use the machine if the cord is damaged or worn.
- Operate the machine only in daylight or in good artificial light.
- Avoid operating the machine in wet grass.
- Always be sure of your footing on slopes.
- Walk, never run.
- Mow across the face of slopes, never up and down.
- Exercise extreme caution when changing direction on slopes.
- Do not mow excessively steep slopes.
- Use extreme caution when reversing or pulling the machine towards you.

SAFETY INFORMATION

- Stop the blade(s) if the machine has to be tilted for transportation when crossing surfaces other than grass, and when transporting the machine to and from the area to be used.
- Never operate the machine with defective guards or shields, or without safety devices, for example deflectors and/or grass collector, in place.
- Switch on the motor carefully according to instructions and with feet well away from the blade(s).
- Do not tilt the machine when switching on the motor, except if the machine has to be tilted for starting. In this case, do not tilt it more than absolutely necessary and lift only the part, which is away from the operator.
- Do not start the machine when standing in front of the discharge opening.
- Do not put hands or feet near or under rotating parts. Keep clear of the discharge opening at all times.
- Do not transport the machine while the power source is running.
- Stop the machine and remove plug from the socket. Make sure that all moving parts have come to a complete stop.
 - Whenever you leave the mower,
 - Before clearing blockages or unclogging chute,
 - Before checking, cleaning or working on the machine,
 - After striking a foreign object. Inspect the machine for damage and make repairs before restarting and operating the machine.
- If the machine starts to vibrate abnormally (check immediately)
 - Inspect for damage,

SAFETY INFORMATION

- Replace or repair any damaged parts,
- Check for and tighten any loose parts.
- Keep all nuts, bolts and screws tight to be sure the machine is in safe working condition.
- Check the grass collector frequently for wear or deterioration.
- Be careful during adjustment of the machine to prevent entrapment of the fingers between moving blades and fixed parts of the machine.
- Always allow the machine to cool down before storing.
- When servicing the blades be aware that, even though the power source is switched off, the blades can still be moved.
- Replace worn or damaged parts for safety. Use only genuine replacement parts and accessories.
- The machine should be supplied via a residual current device (RCD) with a tripping current of not more than 30 mA.
- Ensure that the mains voltage matches the specifications on the rating plate.
- Use only authorised power cables of type H05VV-F, which are no more than 75 m long and suitable for outdoor use. The power cable wire cross section must be at least 2.5 mm². Always completely unroll cable drums before use. Check the cable for damage.
- Keep the power cable away from the cutting tool when working. The cutting blades may damage the power cable and result in contact with live parts. Always run the power cable behind the operator. The extension cable can be accidentally cut. Risk of electric shock!
- Do not use the power cable to pull the plug from the socket. Protect the power cable from heat, oil and sharp edges.

SAFETY INFORMATION

- Switch off the equipment and disconnect the plug from the socket if the power cable is damaged. If the supply cord is damaged, it must be replaced by a special cord or assembly available from the manufacturer or its service agent.
- Do not connect a damaged power cable to the mains. Do not touch a damaged power cable when it is connected to the mains. A damaged power cable may result in contact with live parts.
- Do not attempt to repair the equipment yourself unless you have been trained to do so. Any work not specified in these instructions is to be carried out only by a qualified person.
- Use only spare parts and accessories supplied and recommended by the manufacturer. The use of non-original parts will immediately invalidate the guarantee.
- Before each use, carry out a visual inspection of the equipment. Do not use the equipment if protective devices (e.g. grass collection box), parts of the cutting device or bolts are missing, worn or damaged. To avoid imbalance, damaged tools and bolts are to be replaced only in sets.
- Do not work with the equipment when tired, lacking concentration or under the influence of alcohol or drugs. Always take breaks in good time. Take a sensible approach to the work. A moment of carelessness when using the equipment can result in serious injury.
- Do not overload the equipment. Work only within the specified power range and do not change the regulator settings on the motor. Do not use low-powered machines for heavy work. Do not use your equipment for purposes other than those for which it is designed.

SAFETY INFORMATION

- Do not work with equipment that is damaged, incomplete, or has been modified without the authorisation of the manufacturer. Do not use the equipment with damaged safety devices or screens or with missing safety equipment such as deflection and/or grass collection devices.
- Do not lift or carry the equipment when the motor is running. Risk of injury from cuts.
- Do not use the equipment near inflammable liquids or gases. Non-observance will result in a risk of fire or explosion.
- Keep the equipment in a dry location and out of reach of children.
- Always keep the grass ejection hole clean and clear. Remove cut material only when the equipment is stopped and disconnected from power supply.
- Do not leave the equipment unattended in the workplace.
- When servicing the blades, remember that they can move even if the power source is off.
- Handle the equipment with care. Keep tools sharp and clean, in order to facilitate better and safer work. Follow the maintenance instructions.

Double Insulation

Double insulation is a concept in safety in electric power tools, which eliminates the need for the usual three-wire grounded power cord.

All exposed metal parts are isolated from the internal metal motor components with protecting insulation. Double insulated tools do not need to be grounded.

SAFETY INFORMATION



WARNING

The double insulated system is intended to protect the user from shock resulting from a break in the tool's internal insulation. Observe all normal safety precautions to avoid electrical shock.

NOTE: Servicing of a product with double insulation requires extreme care and knowledge of the system and should be performed only by a qualified technician.

Electrical Connection

This product has a precision-built electric motor. It should be connected to a power supply that is 220-240V~50 Hz, AC only (normal household current). Do not operate this product on direct current (DC). A substantial voltage drop will cause a loss of power and the motor will overheat. If the product does not operate when plugged into an outlet, double-check the power supply.

Extension Cords

When using a power tool at a considerable distance from a power source, be sure to use an extension cord that has the capacity to handle the current the product will draw. An undersized cord will cause a drop in line voltage, resulting in overheating and loss of power.

Before you connect the mower to the mains supply make sure that data on the rating plate are identical to the mains data. Before using any extension cord, inspect it for loose or exposed wires and cut or worn insulation.

SAFETY INFORMATION



WARNING

Keep the extension cord clear of the working area. Position the cord so that it will not get caught on other obstructions while you are working. Failure to do so can result in serious personal injury.

Intended Use

This hover lawnmower is designed for domestic use only:

- This electric hover lawnmower is intended for mowing lawns in domestic and hobby gardens.
- This product is not to be used in wet weather conditions and may not be used to mow wet or unusually high grass.
- This product is intended for private domestic use only, not for any commercial trade use. It must not be used for any purposes other than those described. Any use of the machine that deviates from its intended use will invalidate the warranty.

IN THE BOX

- | | | |
|-----------------------------|------------------------------|---|
| 1. Safety Button | 8. Screw (x2) | 15. Start/Stop Switch Lever |
| 2. Cable Strain-relief Hook | 9. Deck | 16. Spacer (x3) |
| 3. Foam Grip | 10. Roller | (1 spacer is pre-installed under the blade) |
| 4. Upper Handle | 11. Motor Housing | 17. Instruction Manual |
| 5. Wing Knob (x2) | 12. Grass Collection Box Lid | |
| 6. Lower Handle | 13. Spanner | |
| 7. Grass Collection Box | 14. Cable Clip (x3) | |

ASSEMBLY

Assembly Preparation

- Carefully remove all contents from the product packaging.
 - Ensure you have all the accessories and tool(s) needed for assembly and operation. This also includes suitable personal protective equipment.
-



WARNING

If any parts are damaged or missing do not operate this product until the parts are replaced. Failure to pay attention to this warning could result in serious personal injury.



WARNING

Do not attempt to modify this product or create accessories not recommended for use with this product. Any such alteration or modification is misuse and could result in a hazardous condition leading to possible serious personal injury.



WARNING

Do not connect to power supply until assembly is complete. Failure to comply could result in accidental starting and possible serious personal injury.



WARNING

Never operate the mower without the proper safety devices in place and in correct working order. Never operate the mower with damaged safety devices. Failure to pay attention to this warning can result in serious personal injury. Make sure all packing is removed from product parts before starting assembly.

Assembling the Lower Handle (See Figs. 1-2)

- Insert the lower handles into the slots of the deck (Fig. 1). Push down the lower handles until the screw holes are aligned.
- Secure the lower handles with screws (Fig. 2).

Assembling the Upper Handle (See Figs. 3-6)

- Align the screw holes on the upper handle and lower handle, press the upper handle to snap it into the groove (Fig. 3).
 - Secure the upper handle and lower handle with the wing knobs, washers and bolts (Fig. 4).
 - Secure the control cable against the handle frame with the supplied cable clips (Fig. 5).
 - The adjustment spanner can be easily stored on the lower handle cross bar as illustrated (Fig. 6).
-

OPERATION

WARNING

Do not allow familiarity with this type of product to make you careless. Always pay attention when operating this product, not doing so can result in serious injury.

WARNING

Always wear safety goggles or safety glasses with side shields when operating this product. Failure to do so could result in objects being thrown into your eyes, resulting in possible serious injury.

WARNING

Do not use any attachments or accessories not recommended by the manufacturer of this product. The use of attachments or accessories not recommended can result in serious personal injury.

Setting the Cutting Height (See Figs. 7-8)

WARNING

Switch off the equipment, disconnect the plug from the power supply and wait for the blade to come to a complete stop before adjusting the cutting height. A rotating blade can cause injury. Keep your feet away from the deck when adjusting its height.

WARNING

Always handle the blade with care, sharp edges could cause injury. USE GLOVES. Never use more than 3 cutting height spacers. Spacers must only be fitted between the blade and the fan and NEVER between the blade and the bolt.

Before using the mower for the first time, adjust the cutting position to the height best suited for your lawn. The mower can be set to 4 cutting heights between 12mm and 33mm. Choose the appropriate cutting height according to the types and conditions of the grass. For the first cut each season, a higher cutting setting should be selected (Fig. 7).

Position	Cutting Height
1 (0 spacer)	33mm
2 (1 spacer, pre-installed)	26mm
3 (2 spacers)	19mm
4 (3 spacers)	12mm

OPERATION

To set the cutting height:

- Remove the blade bolt, and blade as described in Blade Maintenance.
- For a lower cut, add spacers to a maximum of 3.
- Refit the blade as described in Blade Maintenance.
- The hover height and therefore cutting height of the lawnmower is approximate. Spacers provide the following approximate cutting heights. 0 spacer = 33mm, 1 spacer = 26mm, 2 spacers = 19mm, 3 spacers = 12mm.
- The blade is reversible and can be fitted either way up.

NOTE: Spacers that are not being used can be stored on the spanner to prevent loss (Fig. 8).

Starting/Stopping the Mower (See Figs. 9-10)

- Make a loop in the power cord and hang the loop onto the cable strain-relief hook (Fig. 9).
- Connect the machine to a suitable power supply.
- Before switching the mower on, make sure that the working area is free from debris and foreign objects.
- Press and hold the safety button. Pull the switch lever towards the mower handle and hold in position (Fig. 10).
- Once started, release the safety button. Continue to hold the switch lever against the mower handle as you mow.
- To switch the mower off, release the switch lever.

NOTE: A high-pitched noise and sparking may occur as the electric motor decelerates. This is normal.

NOTE: There are two start/stop switch levers fitted, either one can be used for starting the product.



WARNING

The blade may keep rotating for a few seconds after the device has been switched off. Do not touch the rotating blade. A rotating blade can cause injury.

OPERATION

Emptying the Grass Collection Box (See Fig. 11)

On top of the grass collection box lid is a clear view window through which user can observe the filling condition during the mowing process.

Empty the collection box in time when there is a sign that collection box is full or nearly full by observing the view window.



WARNING

Switch off the equipment, disconnect the plug from the power supply and wait for the blade to come to a complete stop before removing the grass collection box. A rotating blade can cause injury.

- Lift the collection box lid.
- Remove the grass collection box and empty grass clippings (Fig. 11).
- Lift the collection box lid and reinstall the collection box.

General Operation

Check the product, its power cord and accessories for damage before each use. Before use, ensure all power connections are in good working order prior to operation. If damage is present or observed, stop and have mower serviced before use. Do not use the product if it is damaged.

- Double check that the blade is properly installed.
- Always hold the product by its handles. Keep the handle dry to ensure safe support.
- Ensure that the air vents are always unobstructed and clear. Clean them if necessary with a soft brush. Blocked air vents may lead to overheating and damage the product.
- Switch the product off immediately if you are disturbed while working by other people entering the working area.
- Always let the product come to complete stop before removing the grass collection box.
- Always keep the power cord behind you and when you turn, move it to the side that has already been mowed.
- Do not overwork yourself. Take regular breaks to ensure you can concentrate on the work and have full control over the product.

OPERATION

Mowing (See Fig. 12)

- Avoid cutting the power cord. It is advised to mow away from the plug socket and avoid twisting the power cord (Fig. 12). Mow at a normal walking pace and always overlap tracks by a few centimetres for a gap-free finish.
- Make sure the lawn is clear of stones, sticks, wires, and other objects that could damage the lawn mower blades or motor. Such objects could be accidentally thrown by the mower in any direction and cause serious personal injury to the operator and others.
- To reduce the likelihood of disconnecting the lawn mower from the power cord, be sure to use the cord retainer provided.
- When cutting thick grass, reduce walking speed in order to allow for a more effective cut and a proper discharge of the clippings.
- Never cut off more than one-third of the total length of the grass for a healthy lawn. If it is roughly 6cm long, the grass should not be shorter than 4cm once mowed. If the grass is higher, you should gradually cut it down to the desired length so as not to damage the grass. Cutting grass that is too long will result in poor collection performance and may overload the motor.
- Do not cut wet grass because it tends to stick to the underbody of the lawn mower, preventing the proper discharge of grass clippings resulting in poor collection performance.
- Slopes are a major factor related to slip and fall accidents that can result in severe injury. Mowing on slopes requires extra caution. If you feel uneasy on a slope, do not mow it. For your safety, do not attempt to mow slopes greater than 15 degrees.
- Mow across the face of slopes, not up and down. Exercise extreme caution when changing direction on slopes.
- Watch for holes, ruts, rocks, hidden objects, or bumps which can cause you to slip or trip. Tall grass can hide obstacles. Remove all objects such as rocks, tree limbs, etc., which could be tripped over or thrown by the blade.
- Always be sure of your footing. A slip and fall can cause serious personal injury. If you feel you are losing your balance, release the switch lever immediately.
- Do not mow near drop-offs, ditches, or embankments; you could lose your footing or balance.

MAINTENANCE



WARNING

If a part becomes worn or damaged, use recommended manufacturers replacement parts. Use of any other parts may create a hazard or cause product damage.



WARNING

Switch off the equipment before all maintenance and cleaning work, disconnect the plug and wait until the blade stops.



WARNING

Do not use any attachments or accessories not recommended by the manufacturer of this product. The use of attachments or accessories not recommended can result in serious personal injury.

General Maintenance

- Keep all safety devices, air vents and the motor housing free of dirt and dust. Avoid using solvents when cleaning plastic parts. Most plastics are susceptible to damage from various types of commercial solvents and may be damaged by their use. Use clean, dry cloths to remove dirt, dust, oil, grease, etc.
- Periodically check all nuts and bolts for proper tightness to ensure safe operation of the mower.
- Remove any buildup of grass and leaves on or around the motor cover. Wipe the mower clean with a dry cloth occasionally. Do not use water as this may damage any electrical components.

Blade Maintenance (See Fig. 13)



WARNING

Always wear protective, heavy gloves and/or wrap the cutting edges of the blade with rags when performing blade maintenance. Failure to pay attention to this warning could result in serious personal injury.

- Stop the motor and disconnect the power supply. Allow the blade to come to a complete stop.
 - Turn the mower on its side.
 - Wear sturdy gloves and hold the blade firmly. Loosen the bolt with the spanner provided (Fig. 13).
 - Remove the blade bolt, blade, spacer and impeller.
 - Inspect for damage and clean as necessary. If necessary, replace the blade with a new one of the same type.
-

MAINTENANCE

- Reattach the impeller, spacer, blade and blade bolt. Ensure they are located correctly.
- Tighten down clockwise by hand. Hold the blade firmly and tighten the blade bolt with the spanner provided.

NOTE: Renew your metal blade after 50 hours mowing or 2 years whichever is the sooner-regardless of condition. If the blade is cracked or damaged replace it with a new one. Never use a blade bolt if the insulated head is damaged cracked or missing.

Storing the Mower (See Fig. 14)

The device features the following storage options to save space:

- Before storing your mower, ensure the product is disconnected from the power supply.
- Release the wing knobs on both sides of the handle bars.
- Fold the upper handle assembly over the device housing. Making sure that the cables do not become trapped (Fig. 14).
- Store the equipment in a cool, dry location and out of reach of children.
- Allow the motor to cool before storing the equipment in a confined space.
- Do not cover the equipment as moisture could build up.
- The mower may be transported on its roller.

TROUBLESHOOTING



WARNING

Only perform the steps described within these instructions! All further inspection, maintenance and repair work must be performed by a qualified specialist.

Gloves and appropriate protective clothing must be worn when performing these instructions.

Always turn off the machine and disconnect the plug and wait until the blade stops before making any adjustment.

PROBLEM	POSSIBLE CAUSE	SOLUTION
Handles are not in position.	The carriage bolts are not seated properly.	Adjust the height of the handle and make sure the carriage bolts are seated properly.
	The wing knobs are not tightened.	Tighten the wing knobs by rotating clockwise.
The mower does not start.	The power is off.	Check the socket, fuse, cable, wire and plug and have any repairs carried out by a qualified electrician.
	The power cord is not connected to power source.	Connect the power cord to a power source.
	Tripped circuit breaker in the house.	Reset house circuit breaker. If it trips again, call a qualified electrician.
	Defective switch lever or safety button.	Repair by a qualified person.
	The grass is too long.	Set a higher cutting height.
	Jammed blade.	Stop the mower and disconnect from the power supply, then remove the blockage.
The motor stops.	The mower is blocked by foreign object.	Remove the foreign object.
The mower cuts grass unevenly or motor labours.	The lawn is rough or uneven or cutting height not set properly.	Adjust the cutting position to the height best suited for your lawn.
	The blade is blunt.	Replace the blade.
	The blade area is blocked.	Clean the blade area and remove the blockage.

TROUBLESHOOTING

Poor collection performance.	The mowing conditions are not optimal.	Cut long grass down in stages by gradually lowering the height of cut. Wait for wet grass to dry.
	Mowing pattern is incorrect.	Mow in lines up and down the lawn. Do not swing side to side.
The blade fails to rotate.	The blade is blocked by grass.	Remove the grass.
	The blade bolt is loose.	Tighten the blade bolt.
The mower vibrates at higher speed.	The blade bolt is loose.	Tighten the blade bolt.
	The blade is damaged.	Replace the blade.
	The motor shaft is bent.	Stop the motor, disconnect the power source, and inspect for damage. Have repair made by a qualified person.

TECHNICAL DATA

Voltage	220-240V ~ 50Hz
Power	1500W
No Load Speed	4200/min
Cutting Width	33cm
Cutting Height Adjustment	12/19/26/33mm (4 Positions)
Grass Collection Box Capacity	20L
Roller Size	38mm
Weight	8.15kg
Protection Type	IPX4
Noise Level Specification (L_{WA}) Guaranteed	96dB(A)
Vibration (a_n)	<2.5m/s ²
Protection Class	□ / II

RECYCLING AND DISPOSAL



This marking indicates that this product should not be disposed with other household wastes. The machine must be delivered in rigid packaging to avoid damage during transportation. The packaging and the machine itself are manufactured from recyclable materials and should be disposed of accordingly.

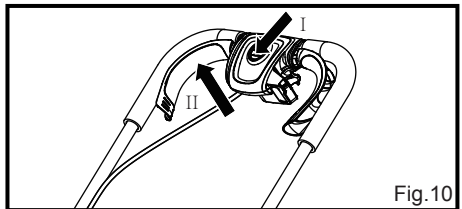
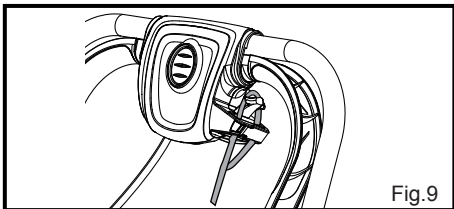
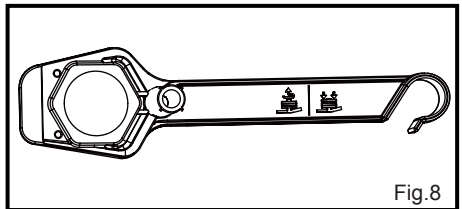
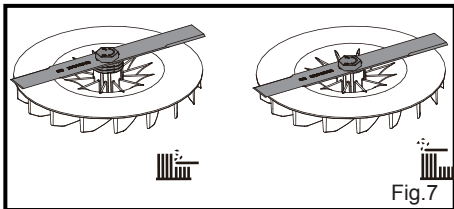
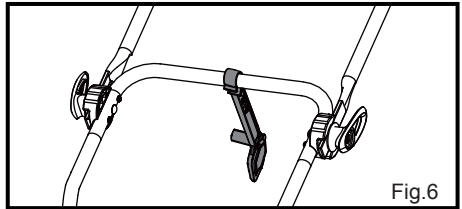
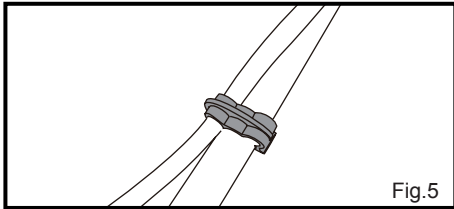
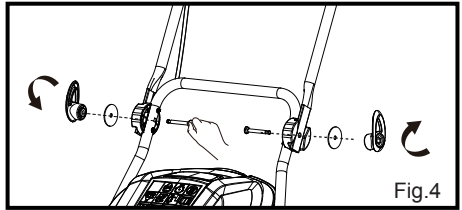
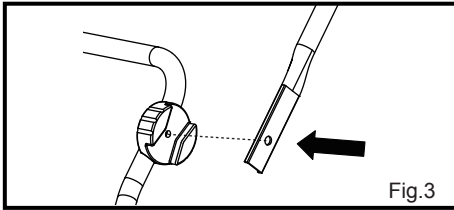
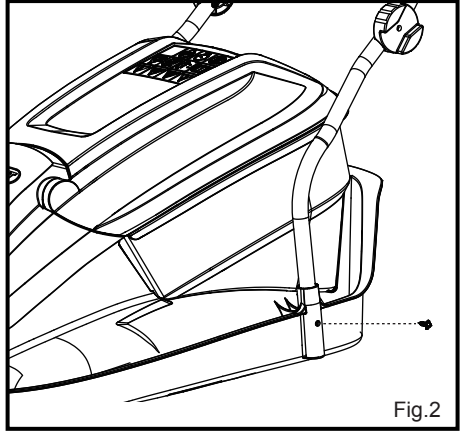
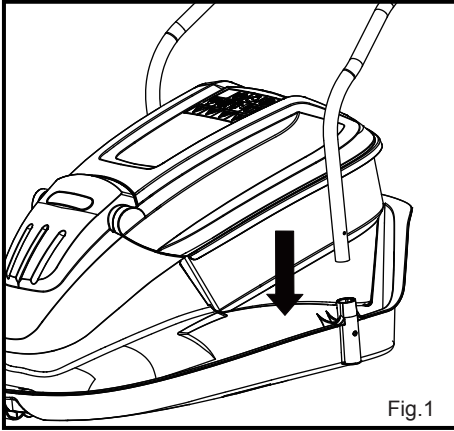

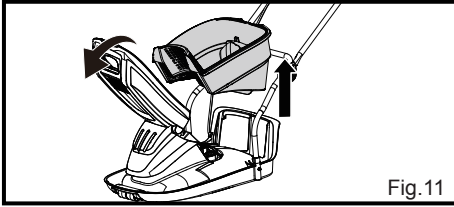

Fig. 11

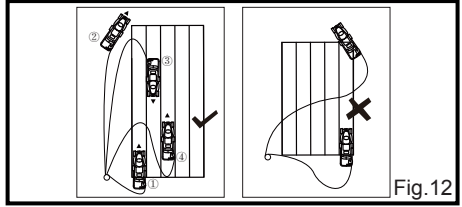

Fig. 12

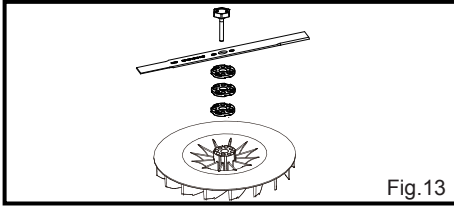

Fig. 13

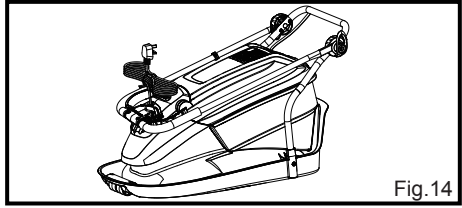

Fig. 14

MEH1533
Suzhou Cleva Electric Appliance Co., Ltd.
No.8 Ting Rong Street
Suzhou Industrial Park, Suzhou
Jiangsu Province, China
www.cleva-europe.com
Made in P.R.C