

LawnMaster®

Instruction Manual

24V Lithium-Ion Cordless Blower CLBL2406-1

CLBL2406-1 01 (With Battery and Charger)

CLBL2406-1-BARE (Battery and Charger Not Included)

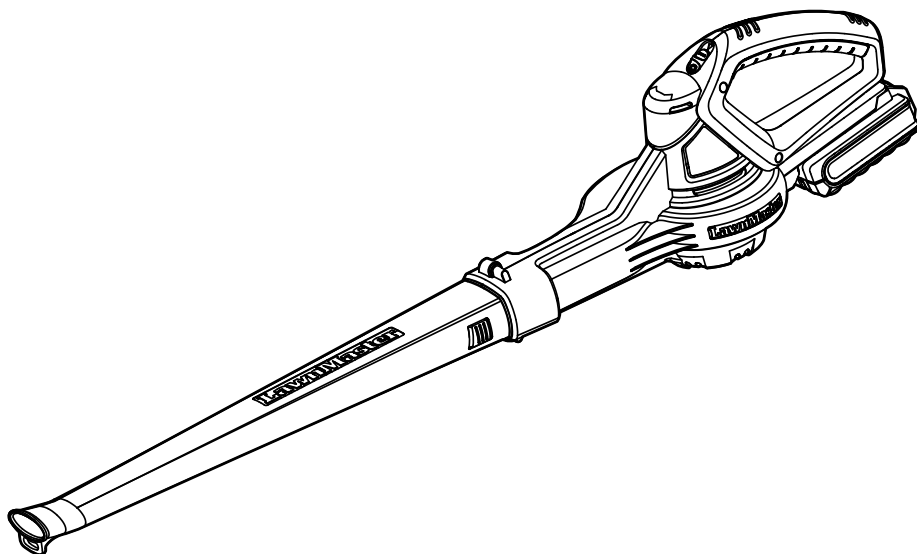

Original Instructions



WARNING: Read all safety instructions carefully before assembling and operating this machine. Ensure the machine has been assembled correctly and safely. Keep the instructions safe and pass them on to any subsequent user so that the information is always available.



UK
CA



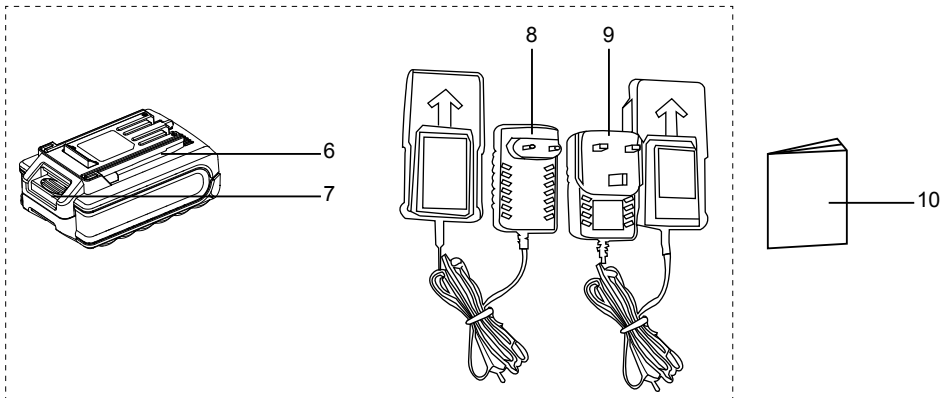
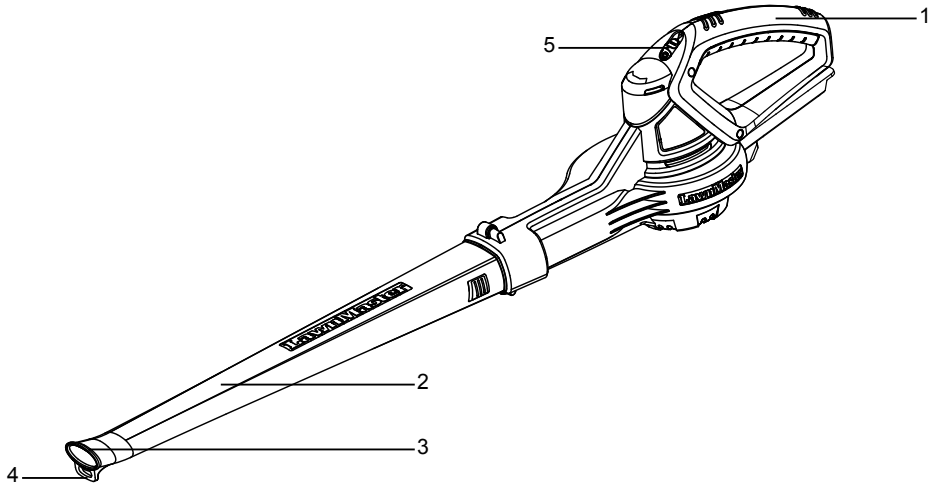

















Not included with CLBL2406-1-BARE

TABLE OF CONTENTS





Section	Page
Symbols	5-6
Safety Information	7-13
In the Box	13
Assembly	14
Operation	15-16
Maintenance	17
Troubleshooting	18
Technical Data	19
Recycling and Disposal	20

SYMBOLS

The following warning symbols appear throughout this manual and indicate the appropriate safety measures you should take when operating and maintaining the appliance.

SYMBOL	DESIGNATION/EXPLANATION
	Caution
	Read instruction manual.
	Keep bystanders away.
	
	Wear eye protection.
	Wear hearing protection.
	Do not use as a step.
	Do not expose to rain.
	Noise level specification L_{WA} in dB(A).
	Protection Class II.
	Keep hands away.
	
	Only recharge battery packs with the supplied charger indoors.
	Disconnect the battery pack before any repair or maintenance.
	Fuse.
	Do not dispose of electrical equipment in domestic waste.
	Batteries contain Li-ion, waste batteries should be sorted for ecofriendly disposal. Do not dispose of waste batteries as unsorted municipal waste.

SYMBOLS

SYMBOL	DESIGNATION/EXPLANATION
	Do not dispose of battery packs in rivers or immerse in water.
	Do not dispose of battery packs in fire.
	Do not subject the battery to direct sunlight over long periods and do not leave it on or near a heat source (max. 60°C).
	Recycle electrical waste products in an environmentally safe way where facilities exist.



WARNING

To avoid serious personal injury, do not attempt to use this product until you read thoroughly and understand completely the instruction manual.

If you do not understand the warnings and instructions in the instruction manual, do not use this product.

SAFETY INFORMATION



WARNING

READ CAREFULLY BEFORE USE. KEEP FOR FUTURE REFERENCE.

Training

- Read the instructions carefully. Be familiar with the controls and the correct use of the machine.
- Never allow children, persons with reduced physical, sensory or mental capabilities or lack of experience and knowledge or people unfamiliar with these instructions to use the machine, local regulations may restrict the age of the operator.
- Keep in mind, that the operator or user is responsible for accidents or hazards occurring to other people or their property.
- Do not allow the machine to be used as a toy. Close attention is necessary when used by or near children.
- Do not handle battery or blower with wet hands.
- Do not expose the blower to rain.

Preparation

- While operating the machine always wear substantial footwear and long trousers. Do not operate the machine when barefoot or wearing open sandals. Avoid wearing clothing that is loose fitting or that has hanging cords or ties.
- Operate the machine in a recommended position and only on a firm, level surface.
- Do not operate the machine on a paved or gravel surface

SAFETY INFORMATION

where ejected material could cause injury.

- Before using, always visually inspect to see, that the fasteners are secure, the housing is undamaged and that guards and screens are in place. Replace worn or damaged components in sets to preserve balance. Replace damaged or unreadable labels.
- Never operate the machine while people, especially children, or pets are nearby.
- Do not leave the blower working unattended .
- To prevent dust irritation the wearing of a face mask is recommended.

Operation

- Keep your face and body away from the air intake opening.
- Wear eye and hearing protection.
- Do not allow hands or any other part of the body or clothing near any moving part.
- Keep proper balance and footing at all times. Do not overreach.
- If the machine should start making any unusual noise or vibration, immediately stop the machine. Remove the battery pack and take the following steps before restarting and operating the machine:
 - i) inspect for damage;
 - ii) replace or repair any damaged parts;
 - iii) check for and tighten any loose parts.
- Keep the battery pack clean of debris and other accumulations to prevent damage to the battery pack or possible fire.
- Stop the machine, and remove the battery pack from the

SAFETY INFORMATION

blower. Make sure that all moving parts have come to a complete stop

- whenever you leave the machine,
- before checking, cleaning or working on the machine.
- Handle the unit with care. Clean the ventilation slots regularly; follow the maintenance instructions.
- Do not overload your device. Work only within the indicated range of performance. Do not use your device for purposes for which it has not been designed.
- Do not attempt to repair the Blower yourself unless you are qualified to do so.
- Turn off all controls before removing battery.

Maintenance and storage

- When the machine is stopped for servicing, inspection, or storage, or to change an accessory, Stop the machine, and remove the battery pack from the blower and make sure that all moving parts are come to a complete stop. Allow the machine to cool before making any inspections, adjustments, etc. Maintain the machine with care and keep it clean.
- Store the machine in a dry place out of the reach of children.
- Always allow the machine to cool before storing.
- Replace worn or damaged parts for safety. Only use replacement parts and accessories supplied and recommended by the manufacturer. Using third-party parts will immediately invalidate the guarantee.
- Store the blower, the charger and the battery at a temperature between 0°C and 25°C.

SAFETY INFORMATION

Battery Safety Information

- Recharge only with the charger specified by the manufacturer. A charger that is suitable for one type of battery pack may create a risk of fire when used with another battery pack. Incorrect use may result in electric shock, overheating or leakage of corrosive liquid from the battery.
- Do not place appliances or their batteries near fire or heat sources. Continuous intense sunlight, fire or other heat sources may cause an increased danger of explosion.
- Do not crush, drop or damage the battery pack. Do not use a battery pack or charger that has been dropped or received a sharp blow. A damaged battery is subject to explosion. Properly dispose of a dropped or damaged battery immediately.
- Batteries can explode in the presence of a source of ignition, such as a pilot light.
- To reduce the risk of serious personal injury, never use any cordless product in the presence of an open flame. An exploded battery can propel debris and chemicals. If exposed, flush with water immediately.
- Do not charge battery in a damp or wet location. Following this rule will reduce the risk of electric shock.
- For best results, your battery tool should be charged in a location where the temperature is more than 4°C but less than 40°C.
- Under extreme usage or temperature conditions, battery leakage may occur. If liquid comes in contact with your skin, wash immediately with soap and water. If liquid gets into your eyes, flush them with clean water for at least 10

SAFETY INFORMATION

minutes, then seek immediate medical attention.

- When the battery pack is not in use, keep it away from other metal objects like: paper clips, coins, keys, nails, screws, or other small metal objects that can make a connection from one terminal to another. Shorting the battery terminals together may cause sparks, burns, or a fire.
- Do not open up the battery and avoid mechanical damage to the battery. Risk of short circuit and fumes may be emitted. Ensure fresh air and seek medical assistance in the event of discomfort.
- Always remove battery pack before storing the device. When battery becomes fully charged, unplug the charger from the power supply and remove the battery pack from the charger.
- Keep battery pack dry, clean, and free from oil and grease. Always use a dry cloth when cleaning. Never use brake fluids, gasoline, petroleum-based products, or any solvents to clean battery pack.

Charger Safety Information

- Ensure the battery pack is charged indoors only, in a dry, cool and well ventilated environment.
- Do not use non-rechargeable batteries!
- Do not operate the charger with a damaged cord or plug, which could cause shorting and electric shock. If damaged, immediately discontinue use. Replace the charger with the identical unit as listed in the Product Specifications in this manual. If the power cord for this equipment is damaged, it must be replaced by the manufacturer, a customer service

SAFETY INFORMATION

agent of the same or a fully qualified person in order to prevent hazards.

- The plug of the charger must match the outlet. Never modify the plug in any way. Unmodified plugs and matching outlets will reduce the risk of electric shock.
- Allow a hot battery to cool before charging.
- Before each use, check the charger, cable and plug. Do not use a defective charger and do not disassemble the charger. Incorrect reassembly may result in the risk of fire, electric shock or electrocution.
- Protect the charger against moisture and wet conditions. There is a danger of electric shock.
- Operate the charger only with the appropriate original batteries. Charging other batteries may result in injuries and risk of fire.
- Keep the cord away from heat, oil, sharp edges or moving parts. Damaged or entangled cords increase the risk of electric shock.
- Do not use a charger that has been dropped or received a sharp blow.
- The voltage indicated on the charger rating plate must correspond to the voltage of the power source.
- Never touch the mains plug with wet hands.

Intended Use

This product is intended for private domestic use only, not for any commercial trade use.

It must not be used for any purposes other than those described. Any use of the machine that deviates from its intended use and is not included in these instructions is

SAFETY INFORMATION

considered unauthorised use and relieves the manufacturer from his or her legal liability.

IN THE BOX

- | | |
|-------------------------------|---|
| 1. Handle | 7. Release Button |
| 2. Blower Tube | 8. MX 24V Battery Charger with VDE plug
(included in mainland EU products only)* |
| 3. High Velocity Tip | 9. MX 24V Battery Charger with BS plug
(included in UK products only)* |
| 4. Storage Hook | 10. Instruction Manual |
| 5. Power Switch | |
| 6. MX 24V 2.0Ah Battery Pack* | |

* Not included with CLBL2406-1-BARE

ASSEMBLY

Assembly Preparation

- Carefully remove all contents from the product packaging.
- Ensure you have all the accessories and tool(s) needed for assembly and operation. This also includes suitable personal protective equipment.

Blower Assembly (See Fig. 1)

- Align the widest end of the blower tube with the front opening on the blower.
- Slide the blower tube over the blower outlet opening until the latch on the blower is inserted into the opening on the blower tube and snaps into place.

Installing/Removing the Battery Pack (See Fig. 2)

IMPORTANT! Before using the blower, read all safety precautions and follow the instructions in the Battery Pack and Charger section. If storing for a prolonged period of time, remove the battery.



WARNING

Follow these instructions in order to avoid injury and to reduce the risk of electric shock or fire:

- Replace the battery pack or the charger immediately if the battery case or charger cord is damaged.
 - Verify that the switch is in the OFF position before inserting or removing the battery pack.
 - Verify that the battery pack is removed and the switch is in the OFF position before inspecting, adjusting, or performing maintenance on any part of the blower.
 - Read, understand, and follow the instructions contained in the section entitled Battery Pack Operation and Charger Operation.
-

To Install the Battery Pack (Fig. 2)

- Align the support rails located on the battery chamber with the guide rails on the battery pack.
- Slide the battery pack fully towards the handle until the latch locks into place. Ensure it is secured.

To Remove the Battery Pack

Press the release button on the battery pack and remove it from the blower.

NOTE: The battery pack fits onto the blower snugly in order to prevent accidental dislodging.

OPERATION

Battery Pack Operation



WARNING

Use only with 24V Lawnmaster® Chargers: MX 24V HYCH0132400500B (EU), HYCH0132400500G (UK), 24LFC12-01 (UK) or 24LFC12-03 (EU).

The battery charger supplied is specifically designed for the lithium-ion battery used in this garden appliance and may cause risk of fire if used with a non-compatible battery pack.

Check the power voltage! Battery chargers operate on 100-240V AC.

Ensure the battery is charged between 4°C and 40°C. This ensures an optimum battery service life.

Protect the battery from heat, from continuous exposure to sun and keep away from radiation or other heat sources. Do not leave the battery in the blower in direct sunlight over long periods.

The battery is supplied partially charged. To ensure full capacity of the battery, charge the battery before using your appliance for the first time. The lithium-ion battery can be charged at any time without reducing its service life. Interrupting the charging procedure does not affect the battery.

Charger Operation (See Fig. 3)



WARNING

Use only with 24V Lawnmaster® MX 24V 24LB2004-C or MX 24V 24LB4005-C battery.

If any part of the charger is missing or damaged, do not operate it! Replace the charger with a new one. Failure to pay attention to this warning could result in possible serious injury.

Check the voltage! The voltage must comply with the information on the rating label.

- Align the battery pack to the slots on the charger. Slide the battery pack in until it locks into place (Fig. 3).
- Connect the charger to the power supply.
- After the battery is charged, it is suggested that the charger be disconnected from the power supply.
- Press the release button on the battery pack and remove it from the charger.

NOTE: It is normal for the battery pack and the charger to become warm during charging process. If the battery does not charge properly, check to make sure the electrical outlet is operational. Always charge the battery before storage!

OPERATION

■ Charger LED (①)

- If the battery is not connected to the charger, a **continuous green LED light** indicates that the plug is plugged into an outlet socket and the battery charger is ready for operation.
- Charging: a **continuous red LED** on the charger indicates that the battery is charging normally.
- Charged: a **continuous green LED** on the charger indicates that the battery is ready for use.
- **Charging Paused: a flashing red LED light** on the charger indicates that charging is paused. Battery temperature is not within the charging temperature range of 4°C and 40°C or the charging voltage is too low. As soon as the permitted temperature is reached, the battery charger will automatically switch to charging.
- After continuous or repeated charging cycles without interruption, the charger may warm up. This is normal and does not indicate a technical defect of the battery charger.

The indicator lights on the charger show the charger status:

INDICATOR LIGHT	STATUS
Red, continuous	Charging
Green, continuous	Fully charged / Connected to power supply (Standby)
Red, flashing	Charging paused

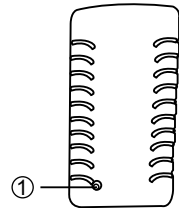

Starting / Stopping the Blower (See Fig. 4)

- Make sure that the battery is installed properly.
- To start the blower, switch the power switch to the "I" ON position.
- To turn off the blower, switch the power switch to the "O" OFF position.

Using the Blower (See Fig. 5)

- Once operational, direct airflow towards the subject you wish to clean.
- Your blower is designed to blow and clean all types of surfaces. From moving debris, leaves and grass clippings into piles or clearing driveways, garages and patios.

WARNING

Always wear eye protection with side shields marked to comply with ANSI Z87.1, along with hearing protection. Failure to do so could result possible serious injury.

MAINTENANCE



WARNING

When servicing, use only recommended replacement parts. Use of any other parts may create a hazard or cause product damage.



WARNING

To avoid serious personal injury, always remove the battery pack from the tool when cleaning or performing any maintenance.

General Maintenance

- Keep all safety devices, air vents and the motor housing free of dirt and dust. Avoid using solvents when cleaning plastic parts. Most plastics are susceptible to damage from various types of commercial solvents and may be damaged by their use. Use clean, dry cloths to remove dirt, dust, oil, grease, etc.
- Remove any buildup of grass and leaves on or around the motor cover. Wipe the blower clean with a dry cloth occasionally. Do not use water as this may damage any electrical components.
- To store the blower, remove the battery pack from the blower and use the convenient storage hook to hang your blower out of the way until next use.

Battery and Charger Maintenance

- Keep the battery and charger clean and clear of debris. Do not allow foreign material into the recessed cavity or on the contacts. Wipe with a dry cloth. Do not use solvents, water, or place in wet conditions.
- Always unplug the charger when there is no battery pack in it.
- Check that the charger and battery contacts have not been shorted by debris or foreign material. Always store away from metal objects which could create a connection with the terminals.
- Always remove the battery when storing the blower and keep in a cool dry place out of direct sunlight.
- Store the battery only within a temperature range between 0°C and 25°C and do not subject or store the battery pack to direct sunlight.
- It is recommended to store the lithium-ion battery pack in a 30%-50% charged condition.
- It is recommended to fully charge the lithium-ion battery pack after every six months of storage.

TROUBLESHOOTING



WARNING

ONLY PERFORM THE STEPS DESCRIBED WITHIN THESE INSTRUCTIONS!



WARNING

REMOVE THE BATTERY PACK BEFORE TROUBLESHOOTING.

PROBLEM	POSSIBLE CAUSE	SOLUTION
Blower will not start when power switch is depressed.	The battery is not secure.	To secure the battery pack, Make sure the latches on the bottom of the battery pack snap into place.
	The battery is not charged.	Charge the battery pack according to the instructions in the instruction manual.
	The battery is defective.	Replace with a new, charged battery.
	Defective power switch.	Contact the After Sales Helpline.
Blower will not blow.	The tube is blocked.	Remove battery and clear debris from in and around tube.
No charging procedure possible.	The battery contacts are contaminated.	Clean the battery contacts (e.g. by inserting and removing the battery several times) or replace the battery.
	Socket outlet, fuse, mains cable or battery charger are defective.	Check the mains voltage and fuse, if necessary have the battery charger checked by an authorised customer service station.
	The battery has a fault.	Contact the After Sales Helpline.

TECHNICAL DATA

24V Cordless Blower

Type	Cordless, Battery-powered
Voltage	24V $\equiv \equiv \equiv$
Max air volume	2.8m ³ /min
Max air speed	53m/s
Sound Pressure Level (L _{PA})	74dB(A) K=3dB
Sound Power Level (L _{WA}) Guaranteed	96dB(A)
Sound Power Level (L _{WA}) Measured	85.1dB(A) K=2dB
Vibration (a _v)	≤2.5m/s ²
Weight (Without 2.0Ah Battery)	1.11kg

CHARGER

Model No.	HYCH0132400500B (with BS Plug, included in UK products only)
	HYCH0132400500G (with VDE Plug, included in mainland EU products only)
Charger Input	100-240V ~ 50/60Hz 0.32A
Charger Output	24V $\equiv \equiv \equiv$ 0.5A
Charging Period (Battery Fully Discharged)	3-5H (For 24LB2004-C)
Weight of Charger	0.2kg
Insulation Protection of Charger	<input type="checkbox"/>

BATTERY

Model No.	24LB2004-C
Rated Voltage of Battery	24V $\equiv \equiv \equiv$
Capacity of Battery	2.0Ah
Battery Type	Lithium-Ion
Weight of Battery	0.41kg

RECYCLING AND DISPOSAL



This marking indicates that this product should not be disposed with other household wastes throughout the EU. The machine must be delivered in rigid packaging to avoid damage during transportation. The packaging and the machine itself are manufactured from recyclable materials and should be disposed of accordingly.



This appliance contains Lithium-ion battery. Do not dispose of batteries in household waste, fire or water. Dispose of batteries in accordance with the local regulations where they will be recycled in an environmentally friendly manner.

Li-ion

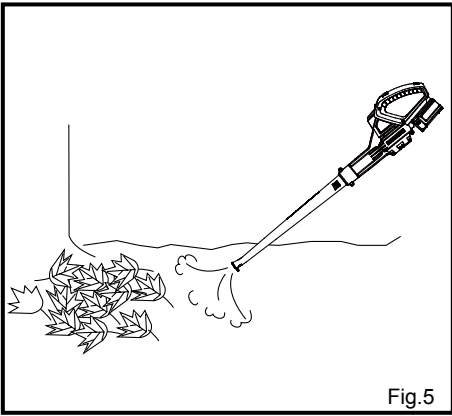
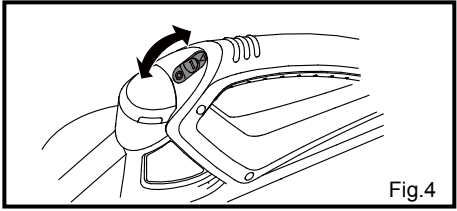
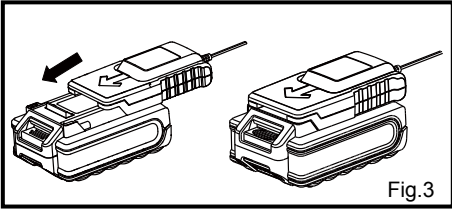
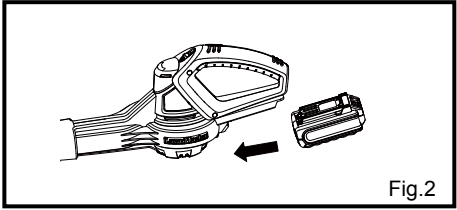
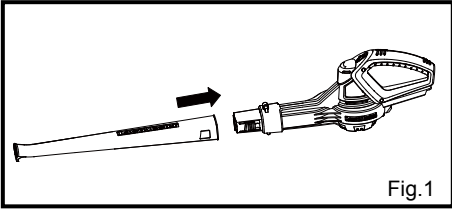

CLBL2406-1
Suzhou Cleva Electric Appliance Co. Ltd
8 Ting Rong Street,
Suzhou Industrial District
215122 Suzhou, Jiangsu Province, P.R.C
www.cleva-europe.com