

 **Vacmaster**[®]

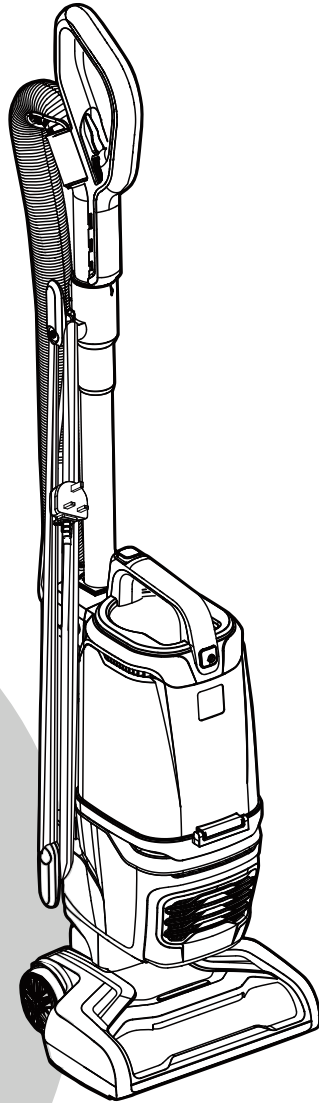

**UK
CA** 

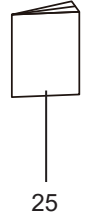
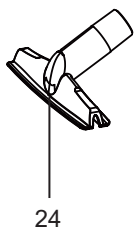
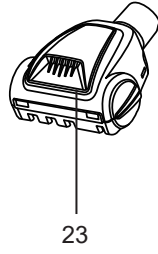
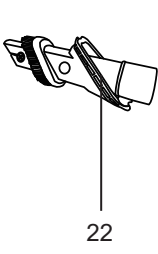
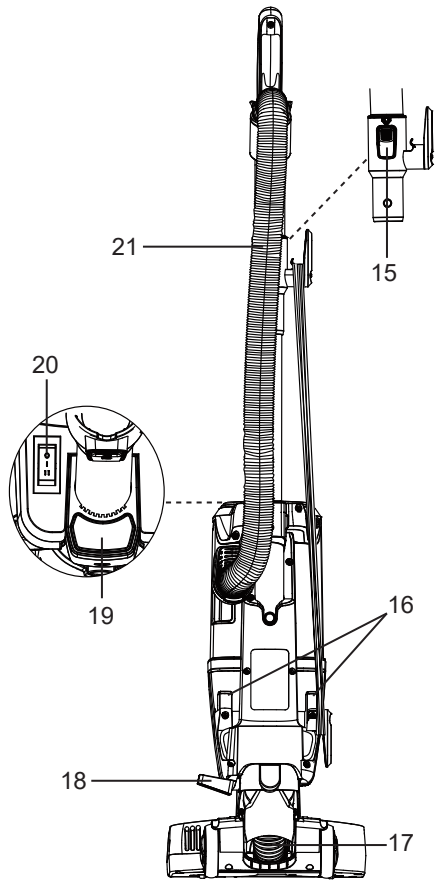
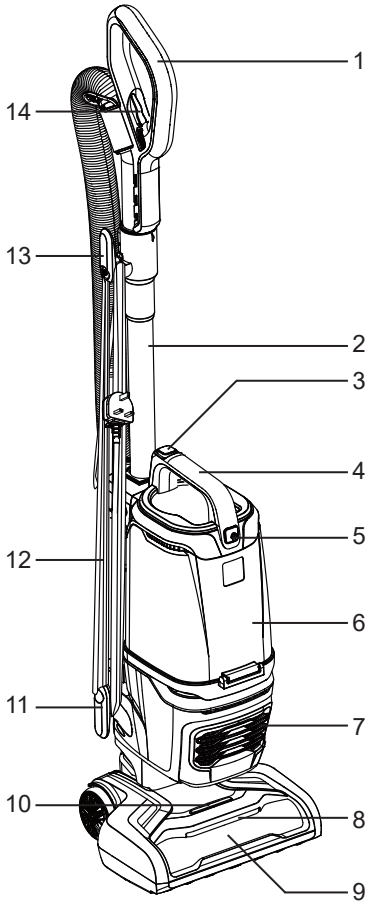





TABLE OF CONTENTS

SECTION	PAGE
Symbols	4
Safety Information	5
Unpacking and Product Features	7
Assembly	8
Operation	9
Maintenance	11
Troubleshooting	14
Technical Data	17
Recycling and Disposal	17
Guarantee	18

Thank you for purchasing this Vacmaster® vacuum cleaner. This is a vacuum cleaner intended for domestic use only and suitable for indoor use within a normal household environment for light, dry dust and debris.

FOR YOUR SAFETY: CAREFULLY READ AND UNDERSTAND ALL INSTRUCTIONS.

SYMBOLS

	Caution.
	Read instruction manual. Failure to follow the warnings and instructions may result in electric shock, fire and/or serious injury.
	Appliance in which protection against electric shock does not rely on basic insulation only but in which additional safety precautions are provided, such as double insulation or reinforced insulation, there being no provision for protective earthing or reliance upon installation conditions.
	Do not dispose of electrical equipment in domestic waste.

SAFETY INFORMATION

READ AND UNDERSTAND ALL INSTRUCTIONS BEFORE USING THIS VACUUM CLEANER.

When using the equipment, a few safety precautions must be observed to avoid injuries and damage. Please read the complete operating manual with due care. Keep this manual in a safe place so that the information is always available. If you give the equipment to any other person, give them these operating instructions as well. We cannot accept any liability for damage or accidents which arise due to a failure to follow these instructions and the safety information.

- This machine is for dry and indoor use only.
- Never leave the appliance switched on unattended, if you leave the work area, switch the appliance off or unplug it from the power supply.
- Do not vacuum or use this vacuum cleaner near flammable liquids, gases or explosive vapours like gasoline or other fuels, lighter fluids, cleaners, oil-based paints, natural gas, hydrogen, or explosive dusts like coal dust, magnesium dust, grain dust or gun powder, or toxic materials. Sparks inside the motor can ignite flammable vapours or dust. Do not vacuum toxic materials.
- This vacuum cleaner is not suitable for the vacuuming of asbestos or asbestos dust.
- Do not vacuum anything that is burning or smoking, such as cigarettes, matches, or hot ashes.
- Do not use the vacuum cleaner in a wet environment or to vacuum wet materials.
- Do not use steam cleaners, pressure washers or immerse in water to clean the vacuum cleaner.
- Ensure the hose and connections are always pointed away from the operators face, hair, ears and eyes during operation and never direct the nozzle towards persons or animals.
- Clear the working area of any items or possessions that you do not wish to be vacuumed before operation.
- Keep cord away from heated surfaces.
- Do not expose to rain. Store indoors only.

- Do not unplug by pulling on the cord. To unplug, grasp the plug, not the cord.
- Do not use with damaged cord, plug or other parts.
- Do not pull or carry by cord, use cord as handle, close a door on cord, or pull cord around sharp edges or corners.
- Do not handle the plug or vacuum cleaner with wet hands.
- Do not use or store near hazardous materials.
- Do not use this vacuum cleaner with a torn filter or without the filter installed.
- Do not allow to be used as a toy. Close attention is necessary when used near children. Do not allow the appliance to be used by children.
- Do not try to touch the brushroll while the vacuum cleaner is switched on and the brushroll is spinning.
- Unplug from power supply when not in use or before carrying out maintenance.
- Turn off vacuum cleaner before unplugging from power source.
- Do not cover the ventilation openings. Do not vacuum with any ventilation openings blocked; keep free of dust, lint, hair or anything that may reduce air flow.
- Keep hair, loose clothing, fingers, all parts of body away from openings and moving parts.
- If the supply cord is damaged, it must be replaced by the manufacturer, a qualified service agent or similarly qualified persons in order to avoid a hazard.
- This appliance is not intended for use by persons (including children) with reduced physical, sensory or mental capabilities, or lack of experience and knowledge, unless they have been given supervision or instruction concerning use of the appliance by a person responsible for their safety.
- Children should be supervised to ensure that they do not play with the appliance.
- Besides the operating instructions and the binding accident prevention regulations valid in the country of use, observe recognized regulations for safety and proper use.
- Before starting work, the operating staff must be informed on
 - use of the vacuum cleaner.
 - risks associated with the material to be picked up.
 - safe disposal of the picked up material.

UNPACKING AND PRODUCT FEATURES

1	Handle	14	Suction Control
2	Wand	15	Handle Release Button
3	Dust Bin Release Button	16	Accessory Storage
4	Carry Handle	17	Connection Hose
5	Dust Bin Lid Release Button	18	Lift Off Release Pedal
6	Dust Bin	19	Wand Release Button
7	Exhaust Filter Cover	20	On/Off Switch
8	Task Lights	21	Flexible Suction Hose
9	Motorised Floor Head	22	3-in-1 Combination Tool
10	Brushroll Status Indicator	23	Pet Mate Tool
11	Lower Cord Hook	24	Upholstery Tool
12	Power Cord	25	Instruction Manual
13	Upper Cord Hook		

ASSEMBLY

1. Remove all the contents from the packaging; make sure you have all contents as listed on page 7.
2. Insert the wand into the main body until you hear a 'click' (Fig. 1).
3. Insert the handle into the wand until you hear a 'click' (Fig. 2).
To remove: Press handle release button and pull up on handle.
4. Insert one end of the flexible suction hose into the main body as shown until you hear a 'click'.
Insert the other end of the hose into the handle until you hear a 'click' (Fig. 3).
5. Insert the combination tool and the upholstery tool onto the accessory storage located on the back of the main body (Fig. 4).
6. Wrap the power cord around the upper and lower cord hooks (Fig. 5).

NOTE: Make sure to wrap the power cord around the upper cord hook first, and then around the lower cord hook to avoid damaging the power cord.

7. Secure the plug to the power cord (Fig. 6).



WARNING: Wrapping the power cord too tightly with excessive stress on the cord may cause damage. A damaged cord is an electrical shock hazard and could cause personal injury or damage.

OPERATION



CAUTION: Moving parts! To reduce the risk of personal injury, DO NOT touch the brushroll when vacuum cleaner is turned on. Contacting the brushroll while it is rotating can cut, bruise or cause other personal injuries. Always turn off before maintenance. Use caution when operating near children or pets (Fig. 7).

1. Power Cord - Release & Use

- 1) Turn the upper cord hook to either side to release the power cord (Fig. 8).
- 2) Detach the power cord plug from the power cord.
- 3) Be sure the power cord is locked into the upper locking notch (①) as shown (Fig. 9).
- 4) Plug the power cord into a power outlet.
- 5) Move the On/Off switch to the desired cleaning operation. Refer to page 9.
- 6) Once you have completed vacuuming, move the On/Off switch to the Off 'O' position and unplug the power cord plug from the outlet.
- 7) Return the upper cord hook into the upright storage position and wrap the cord loosely.



WARNING: If any abnormality/failure occurs, stop using the product immediately and disconnect the power plug.

2. Operation Modes

UPRIGHT MODE

NOTE: Make sure the vacuum cleaner is correctly assembled and the dust bin is empty before using. Do not operate vacuum cleaner without filters in place.

- 1) Release the handle by placing a foot on the floor head nozzle and pull back (Fig. 10).
- 2) To turn the vacuum cleaner on, move the On/Off switch to the desired position (Fig. 11).
 - 'O' Power Off
 - 'I' Hard floor, small area rugs and delicate surfaces. NOTE: The brushroll will not spin in this position.
 - 'II' Carpets. NOTE: The brushroll will spin in this position.



CAUTION: Do not allow the vacuum cleaner to remain in one spot for any length of time when the brushroll is turning. Damage to carpet may occur.

NOTE: Brushroll does not rotate in either mode when handle is in fully upright position.

- 3) Once you have completed vacuuming, switch to the Off "O" position and unplug the power cord from the power outlet.

The brushroll indicator status light:

Colour	Status
Green	The brushroll is spinning and working as intended.
Red	There is a jam in the brushroll area. Turn off and unplug the vacuum. Remove any blockages in the nozzle.
No Light	The brushroll is not active.

ABOVE FLOOR MODE

- 1) Place the vacuum cleaner in the upright locked position.
- 2) Press the wand release button and lift up the wand for above floor cleaning (Fig. 12).
- 3) Choose the desired attachment and insert it into the wand (Fig. 13).



CAUTION: When using attachments, be careful not to over stretch the suction hose to avoid causing the vacuum cleaner to tip over.

LIFT OFF MODE

- 1) Place the vacuum cleaner in the upright locked position.
- 2) Press the Lift Off release pedal with foot to detach and raise vacuum body from floor head (Fig. 14).
- 3) Press the wand release button and lift up the wand for cleaning stairs or other hard to reach places.
- 4) Choose the desired attachment and insert it into the wand or handle (Fig. 15).

3. Attachments

NOTE: All accessories are compatible with both the wand and the handle (Fig. 16).

1) 3-in-1 Combination Tool

Use crevice tool for cleaning in tight spaces (Fig. 17).

Use the dusting brush mode by sliding the adapter towards the end of the tool (Fig. 18). Ensure the locking button (②) is engaged. Use the dusting brush for cleaning loose or delicate surfaces. Press the locking button to remove the tool adaptor. Remove and flip the adapter to use the upholstery brush (Fig. 19). Use in upholstery brush for cleaning fabric surfaces.

To return the combination tool to crevice tool mode, press the locking button and slide the adaptor back down the tool.

2) Pet Mate Tool

Use Pet Mate tool to pick up pet hair and loose debris. Rotating brushroll powerfully, deep cleans dander out of upholstery and other surfaces (Fig. 20).



WARNING: Never use the Pet Mate tool directly on pets.



CAUTION: Moving parts! To reduce the risk of personal injury, DO NOT touch the brushroll when vacuum cleaner is on. Contacting the brushroll while it is rotating can cut, bruise or cause other personal injuries.

3) Upholstery Tool

Use the upholstery tool for cleaning fabric surfaces such as fabric sofa and bedsheets (Fig. 21).

4. Suction Control

To assist with push/pull force of the vacuum on surfaces, the suction control valve can be opened to help reduce suction. Note that for best cleaning results, the suction control valve must be fully closed.

- 1) Slide to "Min" to open the suction control and decrease suction (Fig. 22).
- 2) Slide to "Max" to close the suction control and increase suction (Fig. 22).

MAINTENANCE

IMPORTANT! Unplug the power cord from the outlet before performing any maintenance. Failure to do so could result in electrical shock or personal injury.



WARNING: There are sharp edges inside the motorised floor head to prevent hair entanglement. Do not put any part of the body into the nozzle when servicing or cleaning, or it may cause personal injury.

1. Cleaning Exterior and Attachments

- 1) To clean exterior, or to reduce static electricity and dust build-up, wipe outer surface with a clean, dry, soft cloth.
- 2) Wash attachments in warm soapy water, rinse and air dry.

2. Vacuum Cleaner Storage

- 1) Replace suction hose and attachments in storage position if necessary (see page 8).
- 2) Wrap the power cord loosely around the upper and lower cord hooks. Lock plug retainer onto the power cord.
- 3) Store the vacuum cleaner in a dry, indoor area, on the floor with the handle locked in the upright position.

3. Emptying Dust Bin

When emptying any vacuum cleaner, it is difficult to avoid exposure to dust. To minimize this risk, please ensure that you encase the dust bin in a large bag to empty it and close the bag as tightly as possible round the bin. Remove the dust bin and close the bag as tightly and quickly as possible and dispose of this immediately. It is advisable to wear disposable gloves and a face mask while emptying the cleaner. If at all possible, ask a non-allergy sufferer to empty the dust bin when required.

For best performance, empty dust bin after each use. Never operate vacuum cleaner without dust bin and filters in place.

- 1) Press the dust bin release button to remove the dust bin from the main body (Fig. 23).
- 2) Remove any debris that might be located in the suction port (③) (Fig. 24).
- 3) Position dust bin over the waste receptacle. Press down on the dust release button (④) to open lid (Fig. 25).
- 4) To reinstall the dust bin, align the bottom of the bin with the slots on the bottom of the main body. Tilt back against the body until a click is heard (Fig. 26).

4. Pre-Filter

The pre-filter is located within the dust bin. It is recommended to clean the pre-filter every three months to optimize performance.

NOTE: Make sure dust bin is free of debris before opening.

- 1) Remove the dust bin.
- 2) Press the dust bin lid release button, and open the lid (Fig. 27).
- 3) Clean pre-filter (⑤) by gently tapping over a waste receptacle (Fig. 28).
- 4) Reinstall the dust bin into the main body.

5. Pre-Motor Filters

Regularly rinse the filters to maintain your vacuum's suction power.

Rinse filters with cold water only. Allow all filters to air-dry for at least 24 hours before reinstalling them to prevent liquid from being drawn into electronic parts.

NOTE: When the cleaning of filters no longer restores vacuum cleaner suction to full power, or the filters are worn or broken, replace the filters. To purchase filters, contact the After Sales Helpline.

It is recommended to clean the foam and felt filters with cold water every three months.

- 1) Remove the dust bin.
- 2) Remove the foam (⑥) and felt filters (⑦) (Fig. 29).
- 3) Wash with cold water only. DO NOT use detergent or soap. Squeeze by hand and allow to air dry before reinstalling.

NOTE: DO NOT operate without foam and felt filters installed.

DO NOT wash in the dishwasher.

DO NOT install foam and felt filters if damp.

- 4) Replace felt and foam filters into the vacuum cleaner (Fig. 30).
- 5) Reinstall the dust bin.

6. HEPA Exhaust Filter

It is recommended to clean the exhaust filter with cold water every year.

NOTE: When the cleaning of filters no longer restores vacuum cleaner suction to full power, or the filters are worn or broken, replace the filters. To purchase filters, contact the After Sales Helpline.

- 1) Remove the exhaust filter cover by pulling the tab outward at the bottom of the cover (Fig. 31).
- 2) Press the release tab (⑧) and remove the exhaust filter (⑨) from vacuum cleaner (Fig. 32).
- 3) Wash with cold water only. DO NOT use detergent or soap. Allow to air dry. Allow parts to dry 24 hours before putting back into vacuum cleaner.

NOTE: DO NOT operate without exhaust filter installed.

DO NOT wash in the dishwasher.

DO NOT install the filter if damp.

- 4) Reinstall the exhaust filter into the vacuum cleaner until a click is heard (Fig. 33).
- 5) Insert the exhaust filter cover tabs (10) into the upper slots (11) and lock the exhaust filter cover into place by pressing the lower part of the cover until a click is heard (Fig. 34).

NOTE: Make sure the exhaust filter cover is properly installed.

7. WrapFree™ Brushroll

The motorised floor head is fitted with a WrapFree™ brushroll, which actively removes the hair from the brushroll when vacuuming.

If you see any hair wrapped around the brushroll, continue cleaning, ensuring the On/Off switch is in 'II' position with the brushroll rotating on low pile carpets or tile floors. Hair will be removed from the WrapFree™ brushroll and be sucked into the dust bin.

If you hear a sound change when vacuuming, check for blockages or objects caught in the brushroll (Fig. 35).

- 1) Turn off the vacuum cleaner and unplug the power cord.
- 2) Check and rotate the brushroll counterclockwise to remove the blockage (Fig. 35).

NOTE: If any fibers remain wrapped around brushroll, carefully cut them and remove from the brushroll.

8. Pet Mate Tool



CAUTION: To reduce the risk of injury from moving parts, remove Pet Mate tool from the handle or wand before servicing.

Cut any tangled hair, carpet pile and lint entangled around brushroll (Fig. 36).

9. Checking for Blockages

CHECKING SUCTION HOSE & WAND FOR BLOCKAGES

- 1) Remove the suction hose ends from the main body and the handle by pressing the hose release buttons (12) (Fig. 37).
- 2) Release the wand from the body and make sure that attachments are removed from the wand (Fig. 38).
- 3) Check and remove any debris.

CHECKING CONNECTION HOSE FOR BLOCKAGES

- 1) Press the Lift Off release pedal and lift away the body (Fig. 39).
- 2) Check and remove any debris.

10. Thermal Protector

This vacuum cleaner has a thermal protector which automatically activates to protect the vacuum cleaner motor. If a clog prevents the normal flow of air to the motor, the thermal protector will turn the motor off automatically. This allows the motor to cool in order to prevent possible damage.

To reset thermal protector: Turn the vacuum cleaner off and unplug the power cord from the outlet to allow the vacuum cleaner to cool and the thermal protectors to reset.



CAUTION: Always return the vacuum cleaner to the upright position before using the hose and attachments. Failure to do so may result in overheating of the brushroll motor and can cause the thermal protectors to trip.

Check for and remove clogs, and empty dust bin if necessary. Also check and clean any clogged filters. Wait approximately 50 minutes before restarting vacuum cleaner.

TROUBLESHOOTING



WARNING: Disconnect electrical supply before performing maintenance to the vacuum cleaner. Failure to do so could result in electrical shock or personal injury.

Cleaning Performance

Vacmaster vacuum cleaners are tested for endurance. If your motor is operating, then the most likely cause for a loss in suction is a blockage or an opening in the vacuum.

To maintain a high cleaning performance from your machine, it is important to replace or clean filters as necessary. Empty full dust bin to prevent performance drops. A performance drop with clean filters can only be caused by a blockage in the tools or the hose.

PROBLEM	POSSIBLE CAUSE	SOLUTION
Vacuum cleaner will not run.	The plug is not plugged into the power source.	Plug in firmly, press the On/Off switch to "I" or "II" position.
	The On/Off switch is not pressed to start the vacuum cleaner.	Press the On/Off switch to "I" or "II" position.
	Motor overheating protection during use.	Unplug the power cord and let the vacuum cool down for 50 minutes before restarting it for use.
	Functional fault in the power cord, switch, or motor.	Have the damaged part checked by qualified personnel or contact the after sales helpline.

PROBLEM	POSSIBLE CAUSE	SOLUTION
Dirt pick-up is poor or suction power is weak.	The hose or attachments are not installed correctly.	Check the hose and attachments for correct installation and ensure they are firmly in place.
	Dust bin is not installed correctly.	Check dust bin for correct installation and ensure it is firmly in place.
	Full or clogged dust bin.	Empty the dust bin (page 11-12).
	There is a clog in the flexible suction hose or connection hose of the vacuum cleaner.	Check and remove all clogs. Follow instructions on page 13.
	Suction control is in open position.	Adjust the suction control to increase suction. Follow instructions on page 11.
	The foam filter, felt filter or exhaust filter needs to be cleaned or replaced.	Clean or replace the foam filter, felt filter or exhaust filter. Follow the foam filter and felt filter cleaning or exhaust filter cleaning instructions on page 12-13.
	The flexible suction hose is worn.	Replace the hose assembly. To purchase parts, contact the after sales helpline for assistance.
	The connection hose is worn.	Contact the after sales helpline for assistance.
	The brushroll is worn.	Contact the after sales helpline for assistance.
Dust escapes from the vacuum.	Dust bin is not installed correctly.	Position dust bin correctly and firmly in place.
	Exhaust filter is installed incorrectly.	Check exhaust filter for correct installation. Follow instructions on page 12-13.
	Foam filter, felt filter or exhaust filter is worn or broken.	Check and replace the foam filter, felt filter or the exhaust filter. To purchase parts, contact the after sales helpline for assistance.
Brushroll does not spin.	Handle is in fully upright position.	Move handle to operating position.
	Select the wrong mode.	Press the switch to the "II" position to start the brushroll.
	Brushroll is jammed.	Turn off and unplug vacuum cleaner, remove obstruction, then turn on the vacuum cleaner.
	The belt is worn or broken.	Contact the after sales helpline for assistance.
	Overheat protector of the motorised floor head is activated.	Wait the motorised floor head to cool down, and then restart.

PROBLEM	POSSIBLE CAUSE	SOLUTION
Sound changes.	Exhaust filter cover is installed incorrectly.	Position exhaust filter cover correctly. Follow instructions on page 12-13.
	Air path is blocked.	Check for and remove any clogs and clean the air path. Follow instructions on page 13.
	Attachments in use restrict air flow.	Check attachments for fuzz, lint, pet hair or other debris.
Vacuum turns off on its own.	The power cord plug is loose from the outlet when using the vacuum.	Reinsert the power cord plug fully into the outlet. Avoid pulling or dragging the power cord when using the vacuum.
	Thermal protector is activated.	Turn the vacuum cleaner off and unplug it. Check the air path and dust cup. Allow the vacuum cleaner to cool for a minimum of 50 minutes.
Brushroll status indicator light emits red.	There is a jam in the brushroll area.	Turn off and unplug the vacuum. Remove any blockages in the brushroll. See page 13.
	The brushroll is worn or broken.	Contact the after sales helpline for assistance.

TECHNICAL DATA

Model Number	UC0902EHUK
Voltage	220-240 V ~
Frequency	50-60 Hz
Power Input	800 W

RECYCLING AND DISPOSAL



This marking indicates that this product should not be disposed with other household wastes. The machine must be delivered in rigid packaging to avoid damage during transportation. The packaging and the machine itself are manufactured from recyclable materials and should be disposed of accordingly.

GUARANTEE

The following terms and conditions describe the prerequisites and the key terms associated with our manufacturer's guarantee only and do not affect your statutory rights or the obligations of your retailer and your contract with them.

All Vacmaster products are carefully checked, tested and are subject to our stringent quality control process.

Your Vacmaster appliance is automatically covered by an initial limited 2-year (24 month) guarantee against material and/or workmanship defects from the date of purchase. An extended 1-year (12 month) will be applied on top of the initial manufacturers guarantee period upon registering the product providing a total of 3-years (36 month) guarantee period at no additional cost. The extended warranty offer detailed is limited to residences within UK and Ireland.

The guarantee covers replacement parts and/or replacement of the product (at the manufacturer's discretion) within the guarantee period. All claims must be accompanied by a valid proof of purchase. This guarantee excludes (at the manufacturer's discretion) damage resulting from direct or indirect abuse, negligence, product misuse, accidents, unauthorised repairs or alteration and lack of maintenance.

How to register your extended Guarantee?

If you have purchased your Vacmaster product directly from our website, your product will automatically be registered for the full extended 3-year (36 month) period. If purchased from an independent retailer follow the information below.

To benefit from your products extended guarantee period, simply register your product within 28 days of purchase.

 cleva-europe.com/register

To register your extended guarantee, you will require the product's model number and serial number which are located on the product rating label located on the vacuum cleaner and proof of purchase.

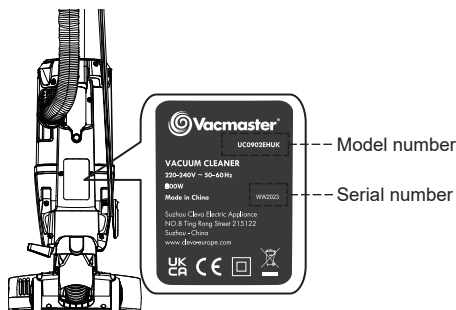

What is not covered by the guarantee?

- Guarantee applies to the original owner and is not transferable nor does it carry a cash value.
- Appliances purchased from an unauthorized dealer.
- Use of appliance not in accordance with the product instruction manual including careless operation or handling, misuse, abuse and/or lack of regular maintenance.
- Unauthorized use of the application or anything other than for domestic purposes e.g. For commercial or rental use.
- Accidental damage or faults caused by negligent use or care.
- Repairs or alterations carried out by unauthorised parties or agents.
- Normal wear and tear of parts and accessories, including normal wearing parts and consumables such as; Dust bin, Brush bar, filter(s) belt drive, fuses, batteries etc.
- Damage caused by blockages or other hazardous materials.
- The use of non-genuine parts and/or accessories.

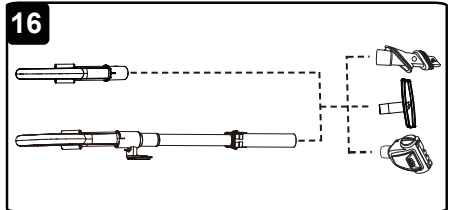
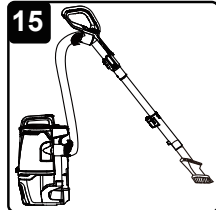
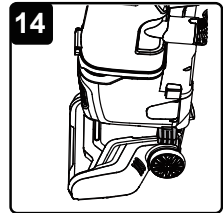
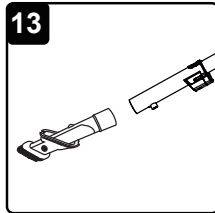
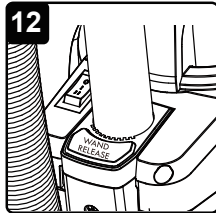
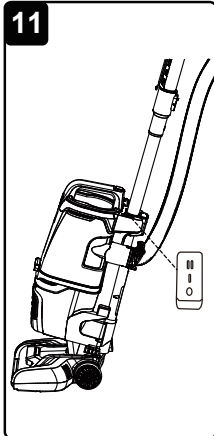
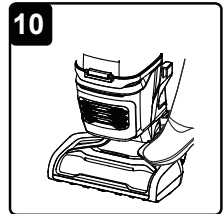
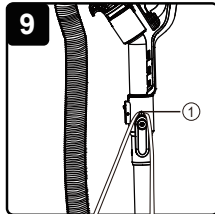
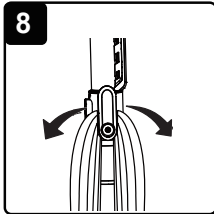
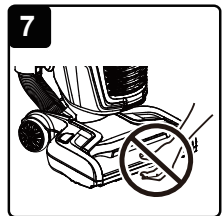
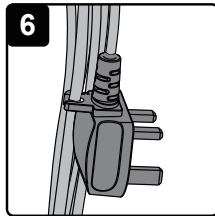
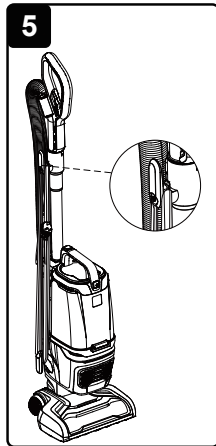
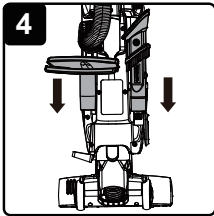
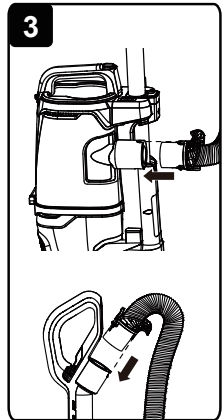
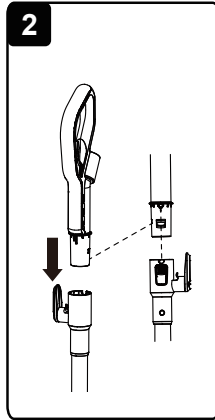
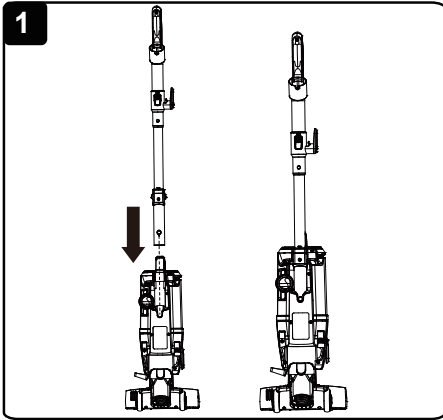

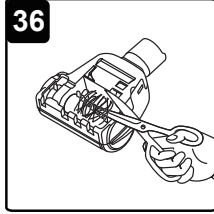
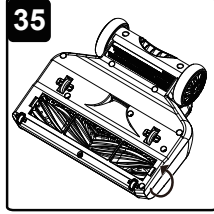
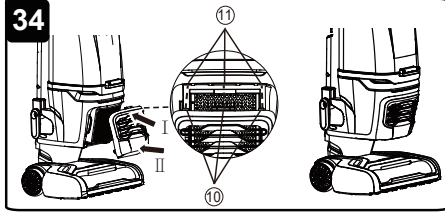
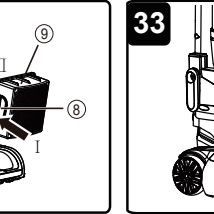
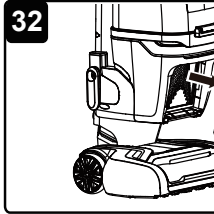
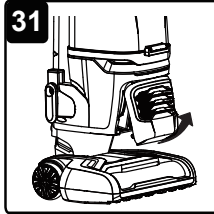
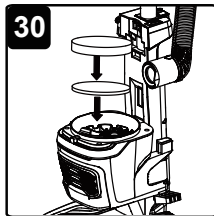
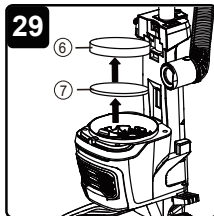
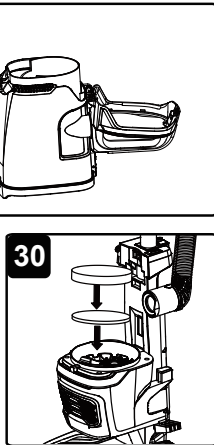
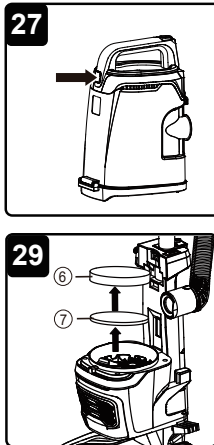
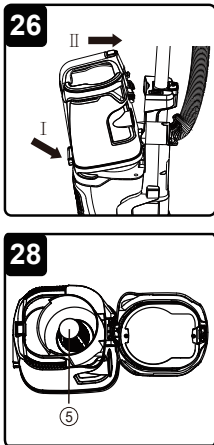
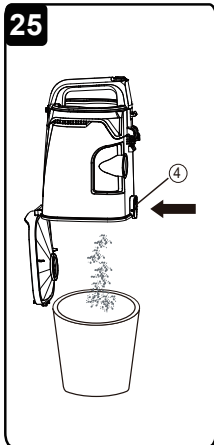
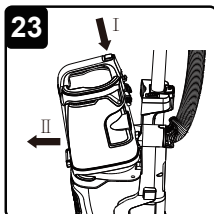
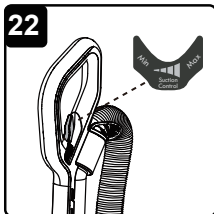
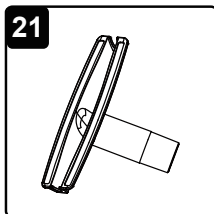
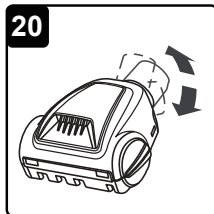
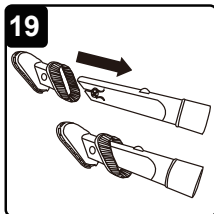
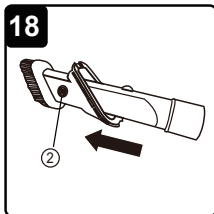
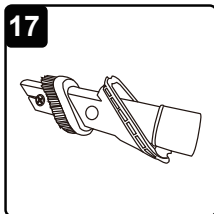

37

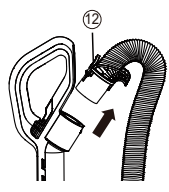
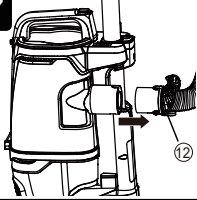

38

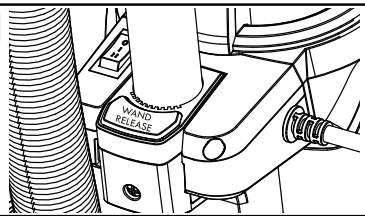

39

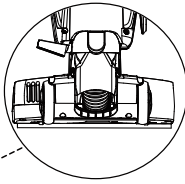
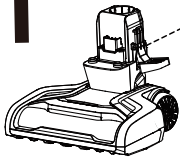
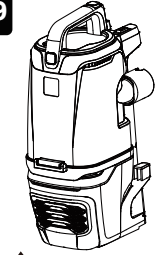



UC0902EHUK
Suzhou Cleva Electric Appliance Co., Ltd.
No.8 Ting Rong Street
Suzhou Industrial Park, Suzhou
Jiangsu Province, China
www.cleva-europe.com
Made in P.R.C