

## **JOEY™ 18V Lithium**

Cordless Vacuum Cleaner

Slimline Design and 2-in-1

Model Number - **VSA1802UK**

Thank you for choosing our JOEY™ cordless vacuum cleaner. This is a cordless vacuum cleaner intended for indoor use on light, dry household dust and debris.

## CONTENTS

Before Using Your New Vacuum Cleaner.....	1
Getting Help.....	1
Safety Information.....	2
Guarantee Information.....	4
Parts and Features.....	5
Assembly Instructions.....	6
Charging Instructions.....	7
Operating Instructions & Tips .....	8
Maintenance and Care.....	10
Troubleshooting.....	14
Technical Data .....	16
Disposal and Recycling .....	16

## BEFORE USING YOUR VACUUM CLEANER

- Please read this instruction manual. It will help you assemble and operate your new vacuum cleaner in the safest and most effective way.
- Keep this instruction book and your sales receipt in a safe place for future reference.

## GETTING HELP

For more information on this product, please visit our website.

**[cleva-uk.com](http://cleva-uk.com)**

## SAFETY INFORMATION

- This appliance can be used by children aged from 8 years and above and persons with reduced physical, sensory or mental capabilities or lack of experience and knowledge if they have been given supervision or instruction concerning use of the appliance in a safe way and understand the hazards involved. Children shall not play with the appliance. Cleaning and user maintenance shall not be made by children without supervision.
- This appliance should only be used for normal vacuuming in a domestic environment.
- Make sure the vacuum cleaner is stored in a dry place.
- Unplug the vacuum cleaner from the charger before cleaning or maintenance.
- Children should be supervised to ensure that they do not play with the appliance.
- Packaging material, e.g. plastic bags should not be accessible to children to avoid suffocation.
- Check that your supply voltage is the same as that stated on the rating plate on the charging adaptor.
- Each vacuum cleaner is designed for a specific charging voltage, use only the original charging adaptor supplied with this vacuum cleaner.
- While there is no shock hazard from electrical terminals located on the vacuum, a burn could result from metal objects being inserted into the terminal areas. Vacuum cleaner terminals should always be kept free of objects.
- Leaks from battery cells can occur under extreme usage or temperature conditions. If the liquid gets on skin, wash quickly with water. If liquid gets into the eyes, flush them immediately with clean water for a minimum of 10 minutes. Seek medical attention.
- Do not mutilate or incinerate batteries as they will explode at high temperatures.

## PROPER USE

- The appliance must only be stored and charged indoors.
- Do not leave the vacuum cleaner in direct sunlight.
- Avoid exposing the vacuum cleaner to strong heat.
- Do not expose the appliance to temperatures below 0 °C or above 40 °C.
- Keep the vacuum cleaner away from your head when using nozzles and tubes.
- Do not use a damaged charger or cable.
- When disconnecting the charging cable from the mains, pull the plug itself to remove it; do not pull on the power cord.
- Do not pull the charging cable over sharp edges or allow it to become trapped.
- If a fault is detected, switch off the appliance and disconnect it from the charging cable and the mains.
- For safety reasons, only authorised or experienced service personnel are permitted to carry out repairs.
- Do not try to touch the brush roll while the cleaner is switched on and the brush roll is turning.
- Switch off the appliance when it is not in use.
- The battery cells within must not be dismantled, short circuited, or placed against a metal surface.

## NEVER USE THIS VACUUM CLEANER

- In wet areas.
- On building rubble.
- Close to flammable gases, etc.
- When the product shows visible signs of damage.
- On sharp objects or fluids.
- On hot or cold cinders, lighted cigarette butts, etc.
- On fine dust, for instance from plaster, concrete, flour, hot or cold ashes.
- Without its filters.

Using the vacuum cleaner in the above circumstances may cause serious personal injury or damage to the product. Such injury or damage is not covered by the warranty or by CLEVA.

## GUARANTEE INFORMATION

Cleva take pride in engineering high quality, durable products.

This product is guaranteed against defects in workmanship and materials for two years from the date of purchase when it is assembled, operated and maintained according to all supplied instructions.

- This guarantee is void if this product is used for anything other than private household purposes.
- This guarantee does not apply to defects due to direct or indirect abuse, negligence, misuse, accidental damage, repairs or alterations or lack of maintenance.
- This guarantee provides benefits which are additional to your statutory rights as a consumer and does not affect your legal rights.

For more detailed information about your guarantee, please visit **[cleva-uk.com](http://cleva-uk.com)**

## PARTS AND FEATURES

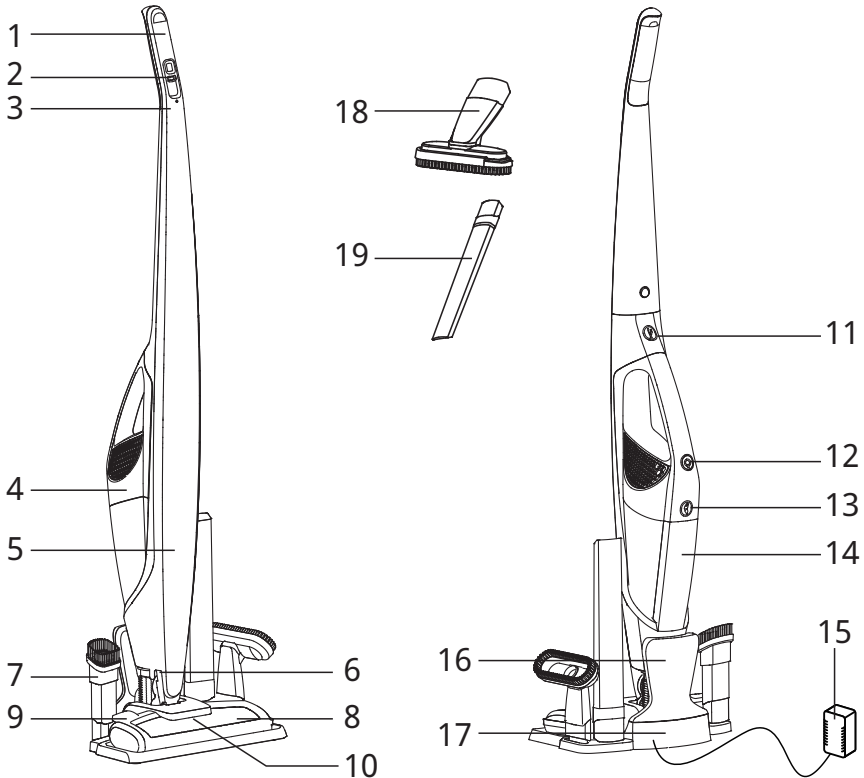

- 1 Handle
- 2 Power/Speed Switch
- 3 Battery Charging Indicator
- 4 Handheld Vacuum Cleaner
- 5 Main Body
- 6 Release Button
- 7 Combination Tool
- 8 Motorised Brush Head
- 9 Brush Cleaning Button
- 10 LED Lights

- 11 Handheld Vacuum Cleaner Release Button
- 12 Handheld Vacuum Cleaner Power Switch
- 13 Dust Bin Release Button
- 14 Dust Bin (Filter Inside)
- 15 Charging Adapter
- 16 Vacuum Cleaner Support
- 17 Charger Base
- 18 Upholstery Tool
- 19 Long crevice Tool

## ASSEMBLY INSTRUCTIONS

- Fit the vacuum cleaner body into the motorised brush head and lock into place (Fig.1).
- Insert the handle into the top of the main body as illustrated and lock into place (Fig.2).
- Insert the handheld vacuum cleaner into the main body as shown and lock into place. Ensure that the dust bin is secure in place (Fig.3).

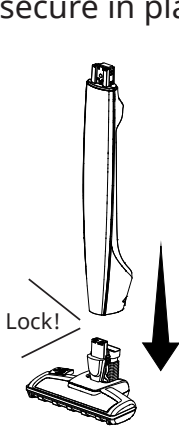

Fig.1

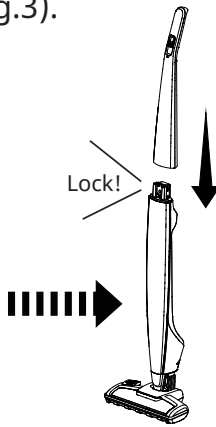

Fig.2

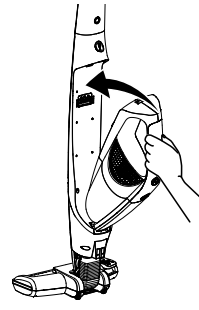

Fig.3

- Insert vacuum cleaner support into charger base and lock into place (Fig.4).
- Insert the charging adapter plug into the charging port on the bottom of the charger base and secure the cord (Fig.5).
- Plug the adapter into a wall socket (Fig.6).

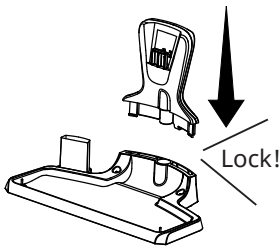

Fig.4

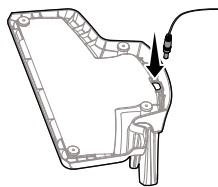

Fig.5

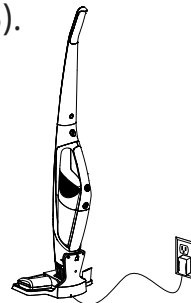

Fig.6

## CHARGING INSTRUCTIONS

Please switch off the unit before placing it on the charger.

- Plug the charging adapter into an outlet. Insert the vacuum cleaner onto the charger base as shown (Fig.7).
- Make sure the vacuum cleaner is fully charged before using for the first time. The vacuum cleaner may take up to 5 hours to charge completely if fully discharged.
- While the vacuum cleaner is being charged, the battery charge indicator will be flashing continuously until fully charged (Fig.8).

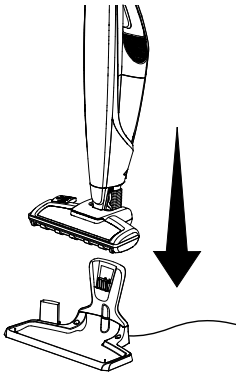

Fig.7

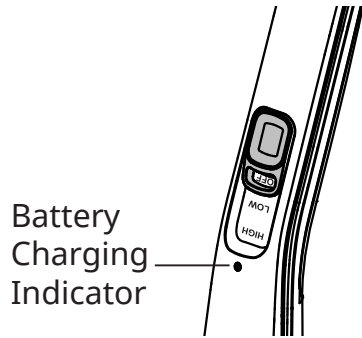

Fig.8

When the vacuum cleaner is fully charged, the battery charging indicator will remain lit for 3 seconds then go to dormant mode with no illuminated lights showing.

**NOTE: If the battery charging indicator does not illuminate when charging, ensure:**

- that the vacuum cleaner is seated properly on to the charger base.
- that the charging adaptor is plugged into the wall socket properly.
- that the wall socket is switched on.
- that the adaptor power plug is connected properly on the charger base.



**NOTE:** For improved battery performance, always keep the vacuum cleaner on the charger base while not in use.

## OPERATING INSTRUCTIONS & TIPS

**! CAUTION!** Moving parts! To reduce the risk of personal injury, DO NOT touch the brush roll when vacuum cleaner is on. Contacting the brush roll while it is rotating can cut, bruise or cause other injuries. Always turn off before servicing. Use caution when operating near children (Fig.9).

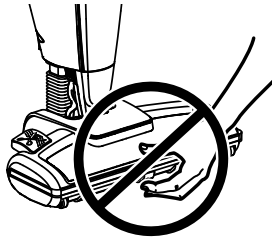

Fig.9

## USING YOUR VACUUM CLEANER

**! WARNING - Do not operate vacuum cleaner without filter in place.**

- Before vacuuming, check that the brush wheels and brush roll are clear from any sharp objects to avoid scratching floors.
- Use low speed for surface cleaning of bare floors or low pile rugs and carpets or when increased runtime is needed.
- Use high speed for cleaning of plush rugs and carpets or when additional cleaning power is required.
- **OFF:** To stop the vacuum cleaner, place the power switch in the OFF position (Fig.10).
- **LOW:** To start the vacuum cleaner, slide the power switch to the LOW speed position (Fig.11).
- **HIGH:** To increase the speed and performance of the vacuum cleaner slide the power switch to the HIGH speed position (Fig.12).



Fig.10



Fig.11

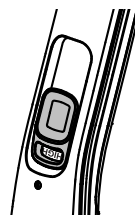

Fig.12

## CLEANING WITH THE HANDHELD VACUUM CLEANER

- To remove the handheld vacuum cleaner, press the release button and detach from the main body (Fig.13).
- To turn on the handheld vacuum cleaner, press the power switch located on top of the handle (Fig.14).
- To clean difficult to reach areas, use the Combination Tool / Long Crevice Tool / Upholstery Brush by inserting end of tool into the handheld vacuum cleaner as shown (Fig.15).

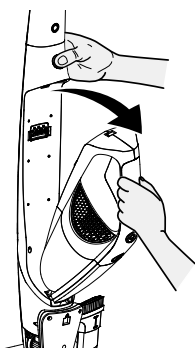

Fig.13

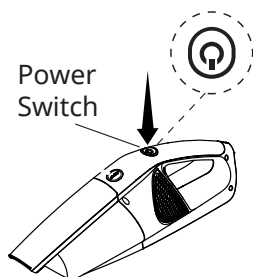

Fig.14

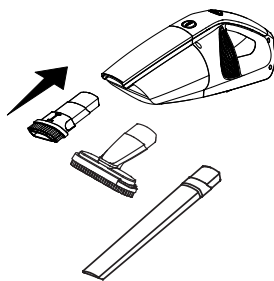

Fig.15

**NOTE:** When battery power is low, the battery charge indicator around the switch will flash.

To charge, place the handheld vacuum cleaner into the main body and place the whole unit onto the charger base

## MAINTENANCE AND CARE

### EMPTYING THE DUST BIN

For best performance, empty the dust bin after every use. Never operate the vacuum cleaner without the dust bin and filter in place.

- Remove the handheld vacuum cleaner from the main body by pressing the release button and detaching the handheld vacuum cleaner (Fig.16).
- Press the dust bin release button and separate the dust bin from the handheld vacuum cleaner body (Fig.17).
- Remove the filter basket from the dust cup. Empty the dust cup contents into a waste bin (Fig.18).

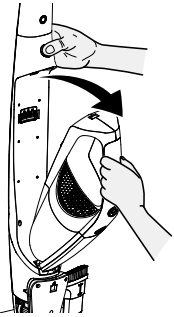

Fig.16

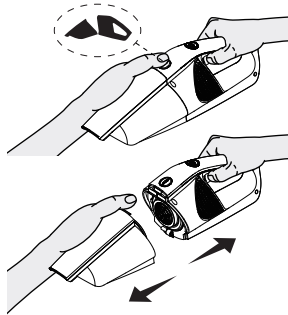

Fig.17

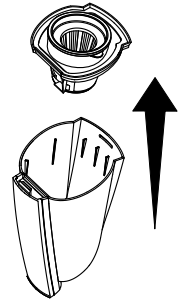

Fig.18

## CLEANING THE FILTER

The key to maximum performance is having a clean filter. Cleaning the filter frequently will help your vacuum cleaner operate at peak efficiency. A spare filter is provided with your vacuum cleaner to allow you to dry 1 filter properly while using the other.

- Remove the filter from the filter basket. With a soft brush, brush accumulated debris from the side screens of the filter basket and from the filter cloth (Fig.19).
- After repeated use, it may be necessary to wash the filter. First brush loose debris from the filter cloth, then hand wash in warm water. After washing, set it aside and allow it to air dry (Fig.20).
- Insert the spare clean, dry filter into the basket, fit the basket into the dust bin, and reconnect the dust bin to the handheld vacuum cleaner (Fig.21).

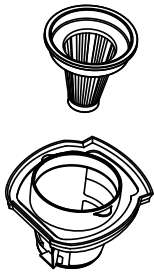

Fig.19

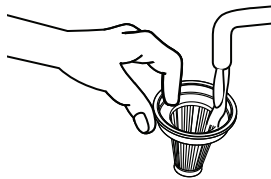

Fig.20

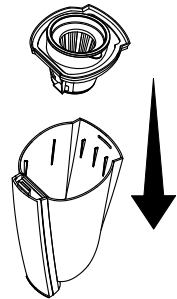

Fig.21

**IMPORTANT:** The filter must be completely dry before reuse. A spare filter is provided with your vacuum cleaner to allow you to dry 1 filter properly while using the other.

## CLEANING THE MOTORISED BRUSH ROLL

The brush roll may accumulate debris such as strings, hair and fibres. This type of debris can wrap around the brush and diminish its ability to clean effectively.

- The brush cleaning system will remove most debris accumulated on the brush roll. To clean the brush roll with the brush cleaning system step on the button as illustrated while the brush roll is spinning (Fig.22).

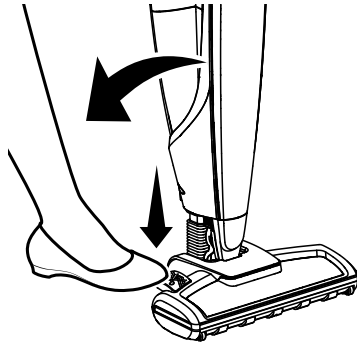

Fig.22

## REMOVING THE BRUSH ROLL FOR CLEANING



**WARNING: This Product contains a brushroll cleaning blade. Do not touch the blade during maintenance. Do not touch moving parts.**

- Ensure the vacuum cleaner is OFF. Turn unit over to access the brush roll, unlock the brush roll tab with flat head screwdriver or similar tool as illustrated (Fig.23).
- Lift the brush roll out of the housing. Clean off debris and anything wrapped around the brush (Fig.24).

- Align the end to the brush drive first, then insert the other end correctly. When installed correctly, the brush roll should rotate freely. Lock the brush in place by closing the tab as illustrated (Fig.25).

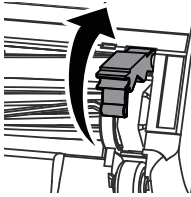

Fig.23

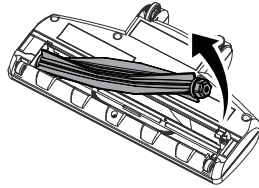

Fig.24

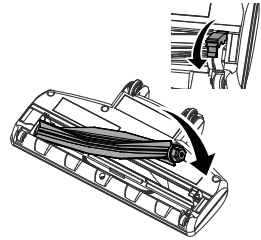

Fig.25

## REMOVING BLOCKAGES

- To clean out the hose, press the hose release tabs, as illustrated, and pull the motorised brush head away from the main body (Fig.26).
- Carefully remove any debris or blockage from the inside of the hose. Reattach the motorised brush head onto the main body (Fig.27).

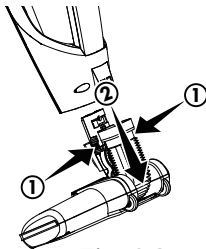

Fig.26

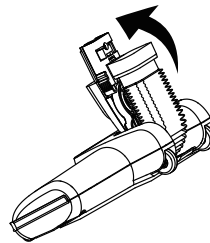

Fig.27

**NOTE: Do not use scissors or other sharp objects to remove a blockage from the hose as these may damage the hose.**

## TROUBLESHOOTING



**WARNING: Disconnect electrical supply before performing maintenance to the vacuum cleaner. Failure to do so could result in electrical shock or personal injury.**

<b>Problem</b>	<b>Possible Cause</b>	<b>Solution</b>
Vacuum cleaner will not turn on.	<ol style="list-style-type: none"> <li>1. Battery may be depleted.</li> <li>2. Wrong charger being used.</li> <li>3. Handheld vacuum cleaner is not installed properly.</li> </ol>	<ol style="list-style-type: none"> <li>1. Charge the battery as instructed on page 7.</li> <li>2. Be sure to use only the charger supplied with your product.</li> <li>3. Remove handheld vacuum cleaner and reattach ensuring that it is securely in place.</li> </ol>
Battery charge indicator does not illuminate.	<ol style="list-style-type: none"> <li>1. Battery may be depleted.</li> <li>2. Charging adapter is not plugged in.</li> <li>3. Debris accumulated on the metal charge contacts on the handheld vacuum cleaner, main body and charging adapter.</li> <li>4. The electrical outlet is switched off.</li> </ol>	<ol style="list-style-type: none"> <li>1. Charge the battery as instructed on page 7.</li> <li>2. Be sure the charging adapter is plugged in properly to the outlet and to the charging hole on the bottom of the charging adapter.</li> <li>3. Be sure no debris is accumulated on the metal charger contacts on the handheld vacuum cleaner, main body and charging adapter.</li> <li>4. Ensure that the outlet is supplying power to the charger.</li> </ol>

<p>Motorized brush not turning.</p>	<ol style="list-style-type: none"> <li>1. Brush roll is jammed.</li> <li>2. Brush roll needs to be reset.</li> <li>3. Brush roll is not installed well.</li> </ol>	<ol style="list-style-type: none"> <li>1. Remove obstruction. Follow instructions on page 12.</li> <li>2. Turn the unit off and remove the obstruction, then turn back on.</li> <li>3. Remove brush roll and reinstall following instructions on page 12.</li> </ol>
<p>Vacuum cleaner not picking up or suction power is weak.</p>	<ol style="list-style-type: none"> <li>1. Dust bin is full.</li> <li>2. Filter needs cleaning.</li> <li>3. Filter needs to be replaced.</li> <li>4. Battery may be depleted.</li> <li>5. Dust bin is not installed well.</li> </ol>	<ol style="list-style-type: none"> <li>1. Empty dust bin.</li> <li>2. Follow filter cleaning instructions on page 11.</li> <li>3. Replace filter.</li> <li>4. Charge the battery as instructed on page 7.</li> <li>5. Check dust bin for correct installation and ensure it is snapped firmly in place.</li> </ol>
<p>Dust escapes from vacuum cleaner.</p>	<ol style="list-style-type: none"> <li>1. Filter is missing or installed incorrectly.</li> <li>2. Filter is damaged and needs to be replaced.</li> <li>3. Dust bin installed incorrectly.</li> </ol>	<ol style="list-style-type: none"> <li>1. Check filter for correct installation.</li> <li>2. Replace filter.</li> <li>3. Position dust bin correctly and snap firmly into place.</li> </ol>
<p>Vacuum cleaner turns off on its own.</p>	<ol style="list-style-type: none"> <li>1. Battery may be depleted.</li> </ol>	<ol style="list-style-type: none"> <li>1. Charge the battery as instructed on page 7.</li> </ol>



## TECHNICAL DATA

Specification	Value
Battery power	18V $\equiv$ 2.0Ah
Battery pack	18V Li-ion
Running time	30 mins max
Speed settings	2 speeds
Dust capacity	0.5L
Weight	2.5 kg
Charger input	100-240V~ 50-60Hz
Charger output	21V $\equiv$ 500mA
Battery full charge time	5 hours

## DISPOSAL AND RECYCLING



Do not dispose with household waste



Recycle products and components according to local legal requirements.



[cleva-uk.com](http://cleva-uk.com)

Cleva UK Ltd  
G2 Stephenson  
Prestwick Park  
Prestwick  
Newcastle upon Tyne  
NE20 9SJ