

VQ1115P / 1250W / 15L



GB WET AND DRY VACUUM CLEANER
Operator's manual

01 - 10

TABLE OF CONTENTS

SECTION	PAGE
Warranty	1
Safety Instructions and Warnings.....	2
Double Insulation Instructions	3
Specifications	3
Unpacking and Checking Carton Contents	4
General Assembly Instructions	5
Dry Vacuum Operation	6
Wet Vacuum Operation	7
Blowing Operation	8
Maintenance.....	8
Installing and Cleaning Reusable Cloth Filter.....	9
Installing and Cleaning Foam Sleeve Filter	10
Troubleshooting.....	10

Thank you for purchasing this Vacmaster® wet and dry vacuum cleaner. Feel confident that with Vacmaster® you are obtaining a high quality product engineered for optimal performance. This vacuum cleaner is capable of picking up liquids and dry materials.

FOR YOUR SAFETY: CAREFULLY READ AND UNDERSTAND ALL INSTRUCTIONS.

WARRANTY

Vacmaster® takes pride in producing a high quality, durable product. This Vacmaster® product carries a limited two (2) year warranty against defects in workmanship and materials from date of purchase under normal household use. Warranty does not apply to defects due to direct or indirect abuse, negligence, misuse, accidents, repairs or alterations and lack of maintenance. Please keep your receipt as proof of purchase.

SAFETY INSTRUCTIONS & WARNINGS

IMPORTANT SAFETY INSTRUCTIONS

READ AND UNDERSTAND ALL INSTRUCTIONS BEFORE USING THIS VACUUM CLEANER.

Read and understand this operator's manual and all labels on the Wet and Dry Vacuum cleaner before operating. Safety is a combination of common sense, staying alert, and knowing how your vacuum cleaner works. Use this Wet and Dry Vacuum cleaner only as described in this manual. To reduce the risk of personal injury or damage to your Wet and Dry Vacuum cleaner, use only Vacmaster® recommended accessories.

SAVE THIS MANUAL FOR FUTURE REFERENCE.

When using an electrical appliance, basic precautions should always be followed including the following:

WARNING: TO REDUCE THE RISK OF FIRE, ELECTRIC SHOCK OR INJURY:

- Do not run vacuum cleaner unattended.
- Do not vacuum, or use this Wet and Dry Vacuum cleaner near flammable liquids, gases, or explosive vapors like gasoline or other fuels, lighter fluids, cleaners, oil-based paints, natural gas, hydrogen, or explosive dusts like coal dust, magnesium dust, grain dust, or gun power. Sparks inside the motor can ignite flammable vapors or dust.
- Do not vacuum anything that is burning or smoking, such as cigarettes, matches, or hot ashes.
- Keep cord away from heated surfaces.
- Do not expose to rain. Store indoors.
- Do not unplug by pulling on cord. To unplug, grasp the plug, not the cord.
- Do not use with damaged cord, plug or other parts.
- If the appliance is not working as it should, has missing parts, has been dropped, damaged, left outdoors, or dropped into water, return it to a service center.
- Do not pull or carry by cord, use cord as handle, close a door on cord, or pull cord around sharp edges or corners.
- Do not run vacuum cleaner over cord.
- Do not handle plug or the vacuum cleaner with wet hands.
- To reduce the risk of health hazards from vapors or dusts, do not vacuum toxic materials.
- Do not use or store near hazardous materials.
- Do not use this vacuum cleaner with a torn filter or without the filter installed except when vacuuming liquids as described in the operation section of this manual.
- Do not allow to be used as a toy. Close attention is necessary when used by or near children.
- To reduce the risk of injury from accidental starting, unplug power cord before changing or cleaning filter.
- Do not leave vacuum cleaner unattended when plugged in. Unplug from power socket when not in use and before servicing.
- Turn off Wet and Dry Vacuum cleaner before unplugging.
- Do not put any object into ventilation openings. Do not vacuum with any ventilation openings blocked; keep free of dust, lint, hair or anything that may reduce air flow.
- Keep hair, loose clothing, fingers, and all parts of body away from openings and moving parts.
- To reduce the risk of falls, use extra care when cleaning on stairs.
- If the supply cord is damaged, it must be replaced by the manufacturer, a qualified service agent or similarly qualified persons in order to avoid a hazard.
- This appliance should not be used by persons under the age of 16 or by persons with reduced physical, sensory or mental capabilities, or lack of experience and knowledge, unless they have been given supervision or instruction concerning use of the appliance by a person responsible for their safety.
- Children should be supervised to ensure that they do not play with the appliance.
- For additional protection: It is recommended that this vacuum cleaner can be used in conjunction with residual current device (RCD) with a rated residual current of 30mA or less.

When using as blower:

- Direct air discharge only at work area.
- Do not use Wet and Dry Vacuum cleaner as a sprayer.
- Do not direct air at bystanders.
- Keep children away when blowing.
- Use safety goggles.

DOUBLE INSULATION INSTRUCTIONS

This Wet and Dry Vacuum cleaner is double-insulated, eliminating the need for a separate grounding system. Use only identical replacement parts. Read the instructions for Servicing Double-Insulated Wet and Dry Vacuum cleaner before servicing. Use this vacuum cleaner as described in this manual.

Observe the following warnings that appear on the motor housing of your Wet and Dry Vacuum cleaner



DOUBLE INSULATED - GROUNDING NOT REQUIRED - WHEN SERVICING USE ONLY IDENTICAL REPLACEMENT PARTS.

WARNING: TO REDUCE THE RISK OF ELECTRIC SHOCK-DO NOT EXPOSE TO RAIN. STORE INDOORS.

WARNING: FOR YOUR OWN SAFETY, READ AND UNDERSTAND OPERATOR'S MANUAL. DO NOT RUN UNATTENDED. DO NOT PICK UP HOT ASHES, COALS, TOXIC, FLAMMABLE OR OTHER HAZARDOUS MATERIALS, DO NOT USE AROUND EXPLOSIVE LIQUIDS OR VAPORS.

CAUTION:

- Do not vacuum drywall dust or fireplace soot or ash. This is a very fine dust which will not be captured by the filter and may cause damage to motor and void the warranty.

WARNING: SERVICING OF DOUBLE-INSULATED WET AND DRY VACUUM CLEANER WITH A DOUBLE-INSULATED WET AND DRY VACUUM CLEANER, TWO SYSTEMS OF INSULATION ARE PROVIDED INSTEAD OF GROUNDING. NO GROUNDING MEANS IS PROVIDED ON A DOUBLE-INSULATED APPLIANCE, NOR SHOULD A MEANS FOR GROUNDING BE ADDED. SERVICING A DOUBLE INSULATED WET AND DRY VACUUM CLEANER REQUIRES EXTREME CARE AND KNOWLEDGE OF THE SYSTEM, AND SHOULD BE DONE ONLY BY QUALIFIED SERVICE PERSONNEL. REPLACEMENT PARTS FOR A DOUBLE-INSULATED WET AND DRY VACUUM CLEANER MUST BE IDENTICAL TO THE PARTS THEY REPLACE. YOUR DOUBLE-INSULATED VACUUM CLEANER IS MARKED WITH THE WORDS 'DOUBLE INSULATED' AND THE SYMBOL  (SQUARE WITHIN A SQUARE) MAY ALSO BE MARKED ON THE APPLIANCE.

- To reduce the risk of electric shock-unplug before cleaning or servicing.
- DO NOT use without filters in place.

CAUTION: TO REDUCE THE RISK OF INJURY FROM MOVING PARTS- UNPLUG BEFORE SERVICING.

SPECIFICATIONS

Motor :	220-240V ~ 50Hz
Container :	15 L
Watt :	1250W
Filter-Dry :	Reusable Cloth Filter
Filter-Wet:	Foam Sleeve Filter

UNPACKING AND CHECKING CARTON CONTENTS

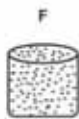
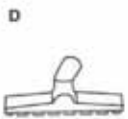
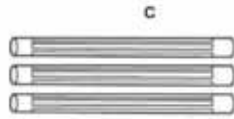
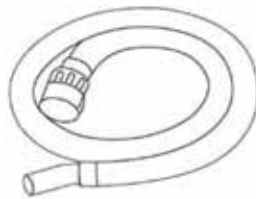

Remove entire contents from carton. Check each item against the contents list.

Contents List

Key	Description.....	Qty
A	Vacuum Cleaner.....	1
B	Hose	1
C	Extension Wands.....	3
D	Floor Nozzle.....	1
E	Crevice Tool.....	1
F	Foam Sleeve Filter.....	1
G	Collection Bag	1
H	Reusable Cloth Filter.....	1
I	Castor.....	4
J	Handle.....	1
K	Operator's Manual.....	1

NOTE: The hose and accessories for this vacuum are 35mm diameter.

Handle

Power Head

On-Off Switch

Blowing Port

Latch

Vacuum Port

Castor

Durable Tank

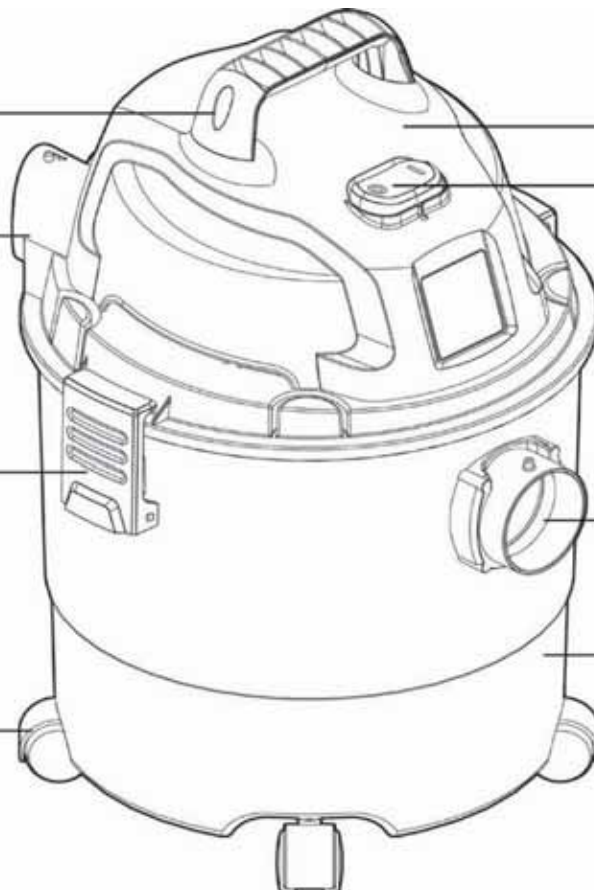

GENERAL ASSEMBLY INSTRUCTIONS

A Philips head screw driver is required for assembly.

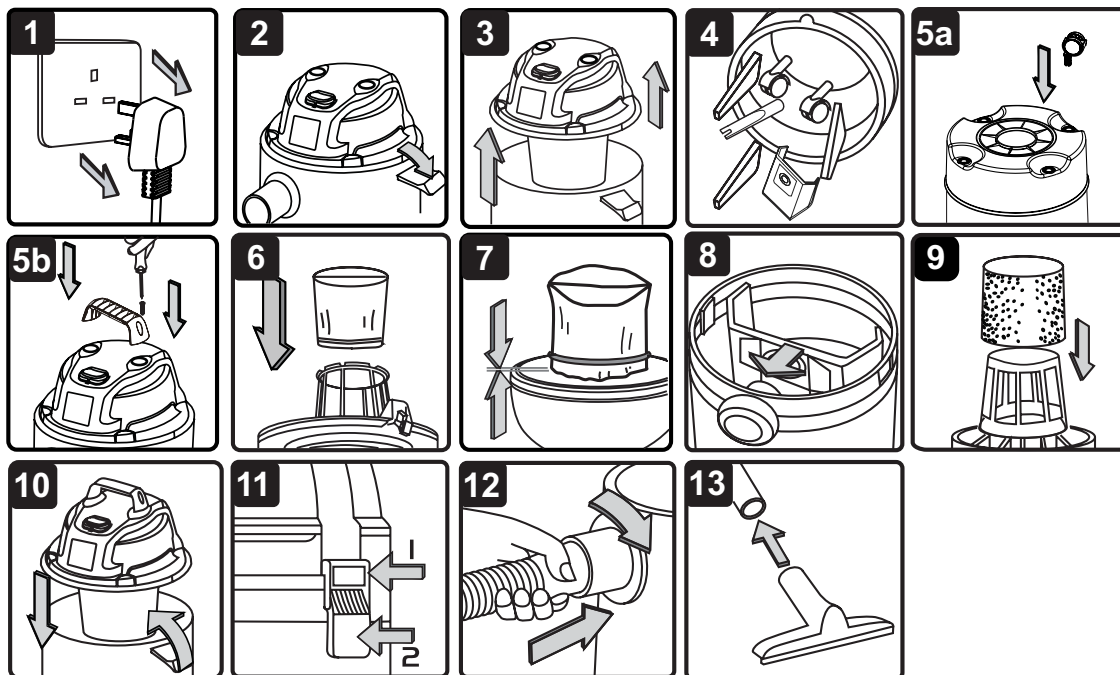

WARNING: DO NOT PLUG IN POWER CORD TO POWER SOCKET, MAKE SURE PLUG IS DISCONNECTED BEFORE ASSEMBLING THE WET AND DRY VACUUM CLEANER

UNPACKING YOUR WET AND DRY VACUUM CLEANER & GENERAL ASSEMBLY

1. Verify that the power cord is disconnected from the power socket. (fig.1)
2. Undo the latches. (fig.2)
3. Lift the power head off the container. (fig.3)
4. Remove the contents from inside the container, make sure you have all contents as listed on page 4. (fig.4)
5. With the power head removed, turn the container upside down. Insert the feet with casters into the slots, apply downward pressure and secure them with supplied screw. Do not over-tighten screws. (fig.5a)
6. Insert the handle into the slots located on the top of the power head and secure it with the screws provided. Do not over tighten the screw. (fig.5b)
7. For dry vacuum cleaning, install the supplied dust filter. (fig. 6&7) See page 9 for filter installation.
8. Optional, for improved dust filtering, fit collection bag onto the tank. Fit the flange onto the inlet stub, taking care not to damage the bag. (fig.8)
9. For wet vacuum cleaning, install the supplied foam filter instead of the cartridge filter. Do not use a collection bag when wet vacuuming. (fig.9) See page 10 for filter installation.
10. Place the power head back on the container, and secure into place using the 2 side latches. (fig.10 & fig.11)
11. Secure the large end of the hose into the vacuum port on the container and lock into place. (fig.12)
12. Choose the desired accessories and extension wands and push onto the suction tube. (fig.13)

DRY-VACUUM OPERATION

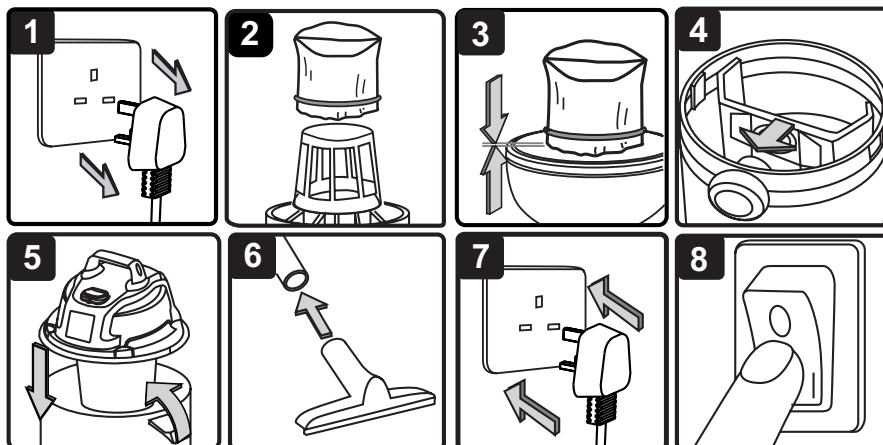

DRY VACUUMING

WARNING: BE SURE TO READ, UNDERSTAND, AND APPLY INFORMATION, ENTITLED 'SAFETY INSTRUCTIONS & WARNINGS'. DO NOT VACUUM IN AREAS WITH FLAMMABLE GASES, VAPORS, OR EXPLOSIVE DUSTS IN THE AIR. FLAMMABLE GASES OR VAPORS INCLUDE BUT ARE NOT LIMITED TO; LIGHTER FLUID, SOLVENT TYPE CLEANERS, OIL-BASE PAINTS, GASOLINE, ALCOHOL OR AEROSOL SPRAYS. EXPLOSIVE DUSTS INCLUDE BUT ARE NOT LIMITED TO; COAL, MAGNESIUM, GRAIN OR GUN POWDER. TO REDUCE THE RISK OF HEALTH HAZARDS FROM VAPORS OR DUST, DO NOT VACUUM TOXIC MATERIALS.

CAUTION:

- Do not vacuum drywall dust or fireplace soot or ash. This is a very fine dust which will not be captured by the filter and may cause damage to motor and void the warranty.

WARNING: DO NOT PLUG IN POWER CORD TO POWER SOCKET. MAKE SURE PLUG IS DISCONNECTED BEFORE CHANGING AND CLEANING FILTERS.

1. Verify that the power cord is disconnected from the power socket. (fig.1)
2. In order to prepare your vacuum cleaner for dry vacuuming, make sure the filter is completely covering the filter cage against the power head. (fig.2 & 3) (Your Wet and Dry Vacuum cleaner comes with the reusable cloth filter preinstalled, if not, see page 9 for installation instructions.)
3. Optional, for improved dust filtering, fit collection bag onto the tank. Fit the flange onto the inlet stub, taking care not to damage the bag. (fig.4)
4. Place the power head back on the container, and secure it in place using the latches. (fig.5)

OPERATING INSTRUCTIONS: DRY VACUUMING

5. Insert the locking end of the hose into the vacuum port and screw in place. Push the required attachment onto the free end of the hose or extension. (fig.6)
6. Plug in the power cord into the power socket. (fig.7)
7. Turn the motor on by flipping the switch to the 'I' ON position. (fig.8)
8. Once you have completed vacuuming, flip the switch to the 'O' OFF position and unplug the power cord from the power socket.

O = OFF I = ON

DO NOT USE THE CLOTH FILTER FOR LIQUID VACUUMING

DO NOT USE A DUST COLLECTION BAG FOR LIQUID VACUUMING

WET-VACUUM OPERATION

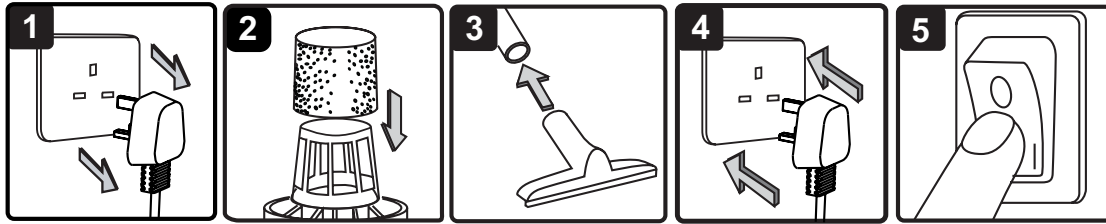

LIQUID VACUUMING

WARNING: BE SURE TO READ, UNDERSTAND, AND APPLY INFORMATION, ENTITLED 'SAFETY INSTRUCTIONS & WARNINGS'. DO NOT VACUUM IN AREAS WITH FLAMMABLE GASES, VAPORS, OR EXPLOSIVE DUSTS IN THE AIR. FLAMMABLE GASES OR VAPORS INCLUDE BUT ARE NOT LIMITED TO; LIGHTER FLUID, SOLVENT TYPE CLEANERS, OIL-BASE PAINTS, GASOLINE, ALCOHOL OR AEROSOL SPRAYS. EXPLOSIVE DUSTS INCLUDE BUT ARE NOT LIMITED TO; COAL, MAGNESIUM, GRAIN OR GUN POWDER. TO REDUCE THE RISK OF HEALTH HAZARDS FROM VAPORS OR DUST, DO NOT VACUUM TOXIC MATERIALS.

WARNING: DO NOT PLUG IN POWER CORD TO POWER SOCKET. MAKE SURE PLUG IS DISCONNECTED BEFORE CHANGING AND CLEANING FILTERS.

1. Verify that the power cord is disconnected from the power socket. (fig.1) Make sure that the container is clean and free from dust and dirt.
2. Remove cloth filter and collection bag, then carefully install the foam sleeve filter over the filter cage and place the power head back on the container. (fig.2) See filter installing instructions on page 10.

**DO NOT USE THE CLOTH FILTER FOR LIQUID VACUUMING.
DO NOT USE A DUST COLLECTION BAG FOR LIQUID VACUUMING.**

OPERATING INSTRUCTIONS – WET VACUUMING

3. Fit the desired nozzle to the vacuum cleaner hose. (fig.3)
4. Verify that the switch is in the 'O' OFF position before plugging the power cord into the power socket. (fig.4)
5. Turn the motor on by flipping the switch to the 'I' ON position. (fig.5)

IMPORTANT! When vacuuming large quantities of liquids, do not immerse the nozzle completely in the liquid; leave a gap at the tip of the nozzle opening to allow air inflow. The machine is fitted with a float valve that stops the suction action when the container reaches its maximum capacity. You will notice an increase in motor noise. When this happens, turn off the machine, disconnect from power supply, and drain the liquid into a suitable receptacle or drain. To continue vacuuming, refit the container with the drain cap.

After wet vacuuming, turn the machine off and remove plug from power supply. Empty the container, clean and dry the inside and outside before storage.

REMEMBER! The foam filter must be removed after wet vacuuming, and a cloth filter must be installed before dry vacuuming again.

BLOWING OPERATION

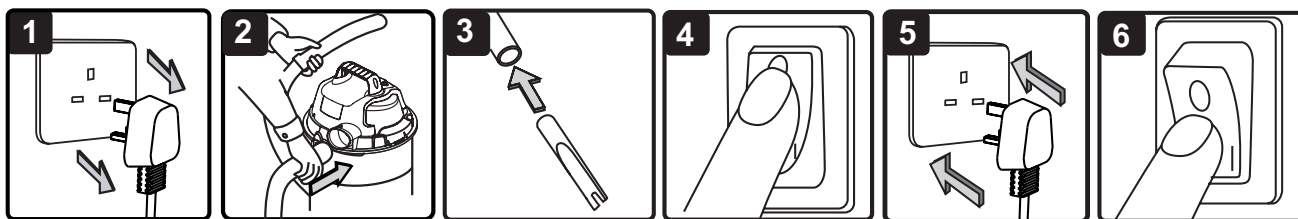

This Wet and Dry Vacuum cleaner has blowing capabilities. To use the blower feature follow the instructions listed.

WARNING: KEEP BYSTANDERS CLEAR FROM BLOWING DEBRIS.

WARNING: WEAR A DUST MASK IF BLOWING CREATES DUST THAT MIGHT BE INHALED.

1. Verify that the power cord is disconnected from the power socket. (fig.1)
2. Make sure the container is empty before using as a blower.
3. Remove hose from the vacuum port.
4. Insert the large end of the hose into the blowing port on the back side of the power head and screw into position. (fig.2)
5. Fit the desired extension wand and / or nozzle to the vacuum cleaner hose. (fig. 3)
6. Verify that the switch is in the 'O' OFF position before plugging the power cord into the power socket. (fig.4, fig.5)
7. Before turning on the vacuum cleaner, firmly hold loose end of the hose. Turn the motor on by flipping the switch to the 'I' ON position. (fig.6)

MAINTENANCE

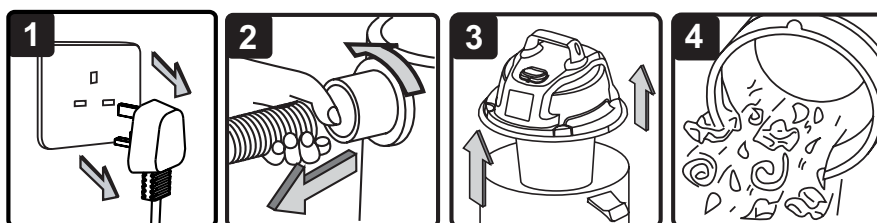

WARNING: DO NOT PLUG IN POWER CORD TO POWER SOCKET. MAKE SURE PLUG IS DISCONNECTED BEFORE CHANGING AND CLEANING FILTERS.

1. Verify that the power cord is disconnected from the power socket. (fig.1)
2. Disconnect the hose from the vacuum cleaner, turning large end in counter clockwise direction. (fig.2)
3. Undo the latches and remove the power head from the container. (fig.3)
4. Clear all dirt or debris from the container and hose. (fig.4)
5. Check the hose, attachments, and power cord to verify that they have not been damaged.

IMPORTANT! Clean or change the cloth filter regularly for best performance. **ALWAYS USE A CLOTH FILTER FOR DRY VACUUMING.** If the machine is used without the cloth filter, the motor will burn out and the warranty will be voided. Always keep spare filters on-hand.

NOTICE! THE FILTERS INCLUDED ARE MADE OF HIGH QUALITY MATERIALS DESIGNED TO STOP SMALL DUST PARTICLES. THE CLOTH FILTER SHOULD BE USED FOR DRY PICK-UP ONLY. A DRY CLOTH FILTER IS NECESSARY TO PICK UP DUST. IF THE CLOTH FILTER IS WET, IT WILL CLOG QUICKLY AND BE VERY DIFFICULT TO CLEAN. HANDLE THE FILTER CAREFULLY WHEN REMOVING IT FOR CLEANING AND REPLACING IT. CHECK THE FILTERS FOR TEARS OR SMALL HOLES, A SMALL HOLE CAN LET DUST PASS THROUGH AND OUT OF THE CLEANER. DO NOT USE A FILTER WITH HOLES OR TEARS, REPLACE IT IMMEDIATELY.

WARNING: ALWAYS DISCONNECT THE PLUG FROM THE POWER SOCKET BEFORE REMOVING THE POWER HEAD FROM CONTAINER.

INSTALLING & CLEANING REUSABLE CLOTH FILTER

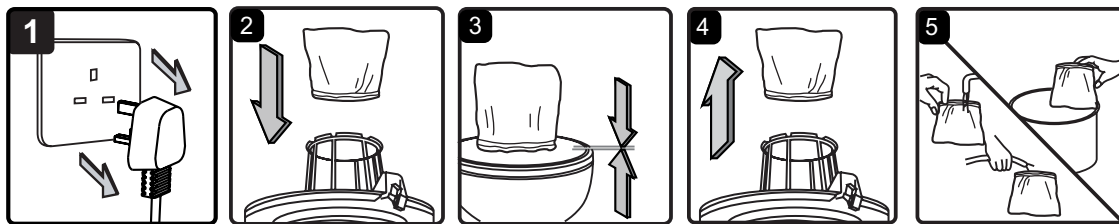

Installing Reusable Cloth Filter

1. Verify that the power cord is disconnected from the power socket. (fig.1)
2. Remove power head and place in upside down position.
3. Slide reusable cloth filter down over the filter cage making sure the whole cage is covered. (fig.2 & 3)
4. Replace the power head on to the container.

Removing and Cleaning Reusable Cloth Filter

1. With the removed power head in the upside down position.
2. Carefully remove the reusable cloth filter from the filter cage. (fig. 4) Clean the filter by gently tapping or brushing dirt off. Cleaning should not be done indoors in living areas.
3. Use a mild soap and water solution to wash reusable cloth filter and rinse with clean water. (fig. 5)
4. Allow the wet filter to air dry for 24 hours before installing onto the filter cage.

INSTALLING & CLEANING FOAM SLEEVE FILTER

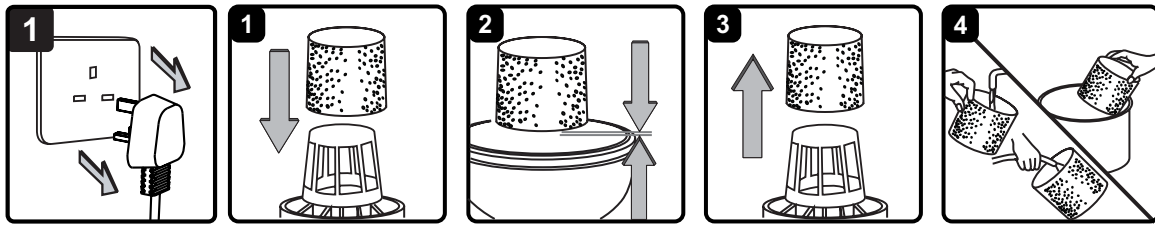

Installing Foam Sleeve Filter

1. Verify that the power cord is disconnected from the power socket. (fig.1)
2. Remove power head and place in upside down position. Follow instructions to remove cloth filter.
3. Carefully slide foam sleeve filter down over the filter cage making sure the whole cage is covered. (fig.2 & 3)
4. Replace the power head on to the container.

Cleaning Foam Sleeve Filter

1. With the removed power head in the upside down position, carefully remove foam sleeve filter. (fig.4)
2. Use a mild soap and water solution to wash foam sleeve filter and rinse with clean water. (fig.5)
3. Allow filter to air dry before installing and using again.

TROUBLESHOOTING

WARNING: TO REDUCE THE RISK OF ELECTRIC SHOCK-UNPLUG BEFORE TROUBLESHOOTING.

Symptom	Possible Causes	Corrective Action
Vacuum cleaner will not operate	1) No power supply.	1) Check power supply – cord, breakers, fuses.
	2) Faulty power cord.	2) Unplug and check the power cord. If damaged, have it repaired by a professional.
	3) Container full.	3) Empty container.
Dust comes from motor cover.	1) The reusable cloth filter is missing or damaged.	1) Attach or replace the reusable cloth filter.
Reduced efficiency and motor/speed vibration.	1) There is a blockage in the nozzle, hose, or the vacuum inlets. Or the dust filter is blocked by fine dust.	1) Check nozzle, hose and container inlets for blockage. Take off the filter and clean it. Or install new filter.

