

dpLCD-T Instructions



CONTENT

1.About the user manual.....	3
2.Outlook and size.....	4
2.1 Material and color	4
2.2 Button definition	5
3.Function summary.....	6
4.Setup summary.....	7
4.1 Reset Trip distance to 0.....	7
4.2 Wheel diameter setting.....	7
4.3 KM/H&MPH.....	7
4.4 Setting instrument voltage.....	Error! Bookmark not defined.
5.Wire order definition.....	8
6.Common problems and solutions.....	9
7.Quality & Warranty.....	10
8.Error code table	11

1.About the user manual

Dear users, in order to operate your electric car better, please read the dpLCD-T instrument manual carefully before use. We will tell you every step of the instrument in the most concise language, from hardware installation and setup to normal use of the instrument. At the same time help you solve the confusion and obstacles that may arise.

2.Outlook and size

2.1Material and color

dpLCD-T products are made of black ABS material and the bracket is made of nylon material. Under the temperature of -20 to 60°C, the shell material can ensure normal usage and good mechanical performance of the products.

Dimension figure (unit: mm).

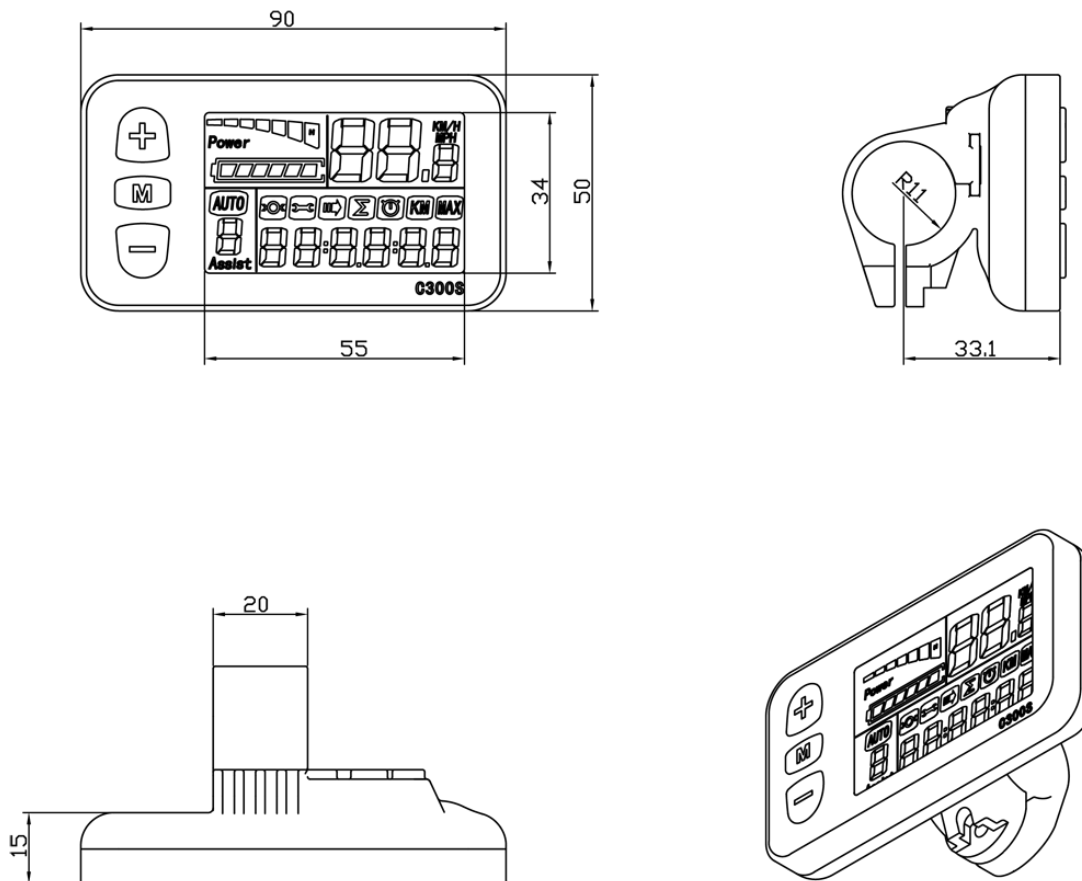

2.2 Button definition

dpLCD-T has three buttons, including UP、 M and DOWN.

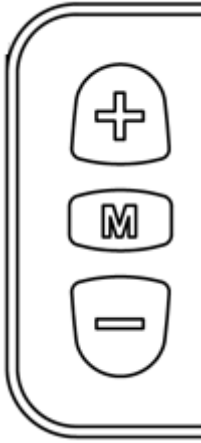

3.Function summary

dpLCD-T provides a wide range of functions and indicators to fit the users' needs. The indicated contents are as below.

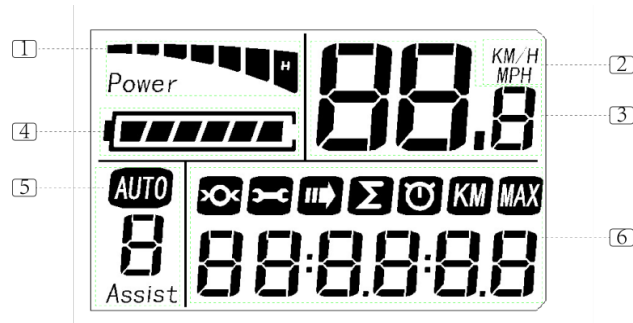

3.1 Current display:

The discharging current of the controller currently, each segment is 2A.

3.2 KM/H&MPH:

Select KM/H or MPH as the current display unit.

3.3 Speed display:

Display the speed at present.

3.4 Electric quantity display:

Display current electric quantity.

3.5 AUTO& Assist:

- ◆ AUTO: Hold the DOWN for 1.5 seconds to get in 6km work.

- ◆ Assist: Displays the current output power.

3.6 Riding information display:

- ◆ Display wheel diameter: Display current wheel diameter information when setting the interface.
- ◆ Error: Displays the current error code.
- ◆ Cycle times display: This feature is not available by default.
- ◆ ODO: The ODO records the driving mileage from using the accumulated value cannot be cleared.
- ◆ TIME: Display the time when the speed of a single ride is higher than 5KM/H.
- ◆ TRIP: Display the user's one-way mileage.
- ◆ Max speed: display current max speed.

3.7 Turn on the headlight and backlight:

Hold the UP for 2 seconds to turn on the headlight and backlight.

4.Setup summary

Click **UP** and **DOWN** 2 seconds enter setting interface.

4.1 Reset Trip distance to 0.

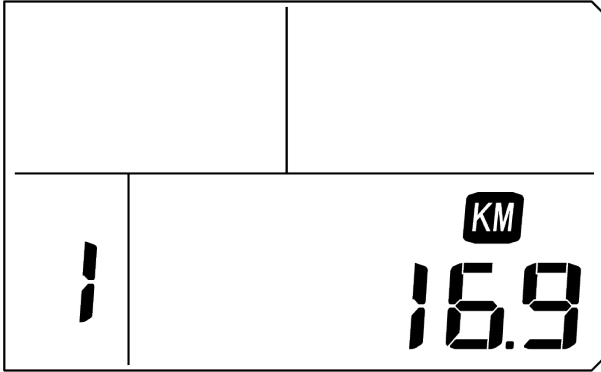

4.2 Wheel diameter setting.

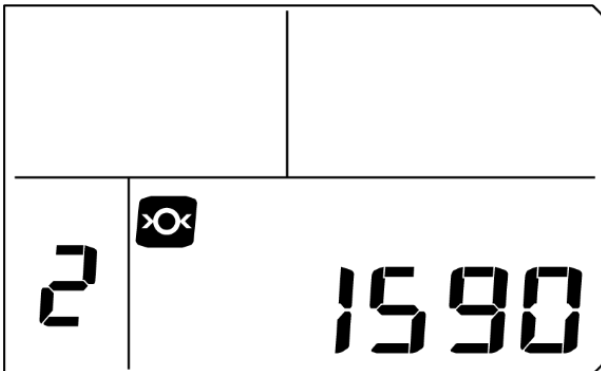

4.3 KM/H&MPH.

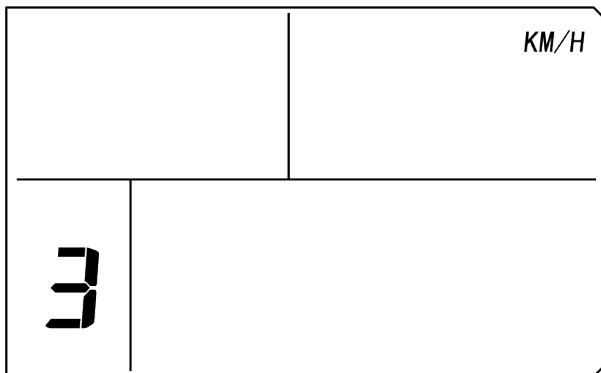

4.4 Setting instrument voltage.

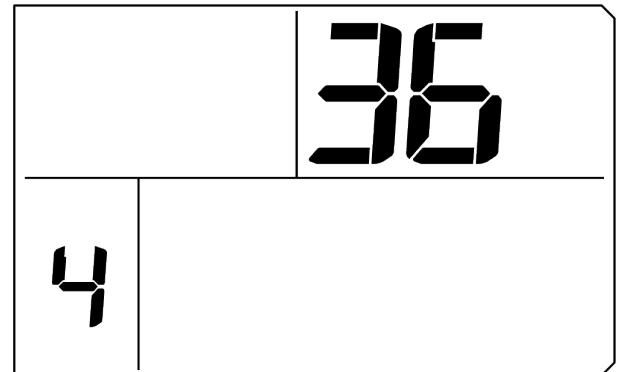

※When the riding speed is 0 km/h for 5 minutes, the system will go to sleep automatically.

5. Wire order definition

Wires sequence	Wires color	Function
1	Red	Battery+
2	Yellow	Weak lock
3	Black	Battery-
4	Green	UART - RECEIVE (RXD)
5	Blue	UART - SEND (TXD)

6.Common problems and solutions

Q: Why the display is not able to start up?

A: Checking the connector that between display and controller.

Q: How to deal with the error code?

A: Fix it to the maintenance place immediately. If cannot be resolved, you can go to the electric vehicle repair points repair it in a timely manner.

7. Quality & Warranty

Any quality problems in normal case and in guarantee period, our company will responsible for the warranty

The warranty time is 18 months from date of purchasing.

Other items:

The following items are not belong to warranty scope:

1. It can't be demolished.
2. The damage caused by wrong installation or operation.
3. Shell is broken when display is out of the factory.
4. Wire is broken.
5. Force disaster (such as fire, earthquake, etc.) or natural disasters like lightning, etc caused by fault or damage.
6. Beyond Warranty period.

8.Error code table

The error code is corresponding with the fault definition.:

Error code	Definition
0	Normal
2	Current error or MOS damaged
3	Motor stalling
4	Low Voltage
5	Brake error(Start detection)
6	Hall error
7	Throttle error(Start detection)
8	High temperature
9	Over voltage
10	Communication controller receiving error
11	Wheel sensor error
12	Controller MCU error
15	Communication display receiving error