

F-F

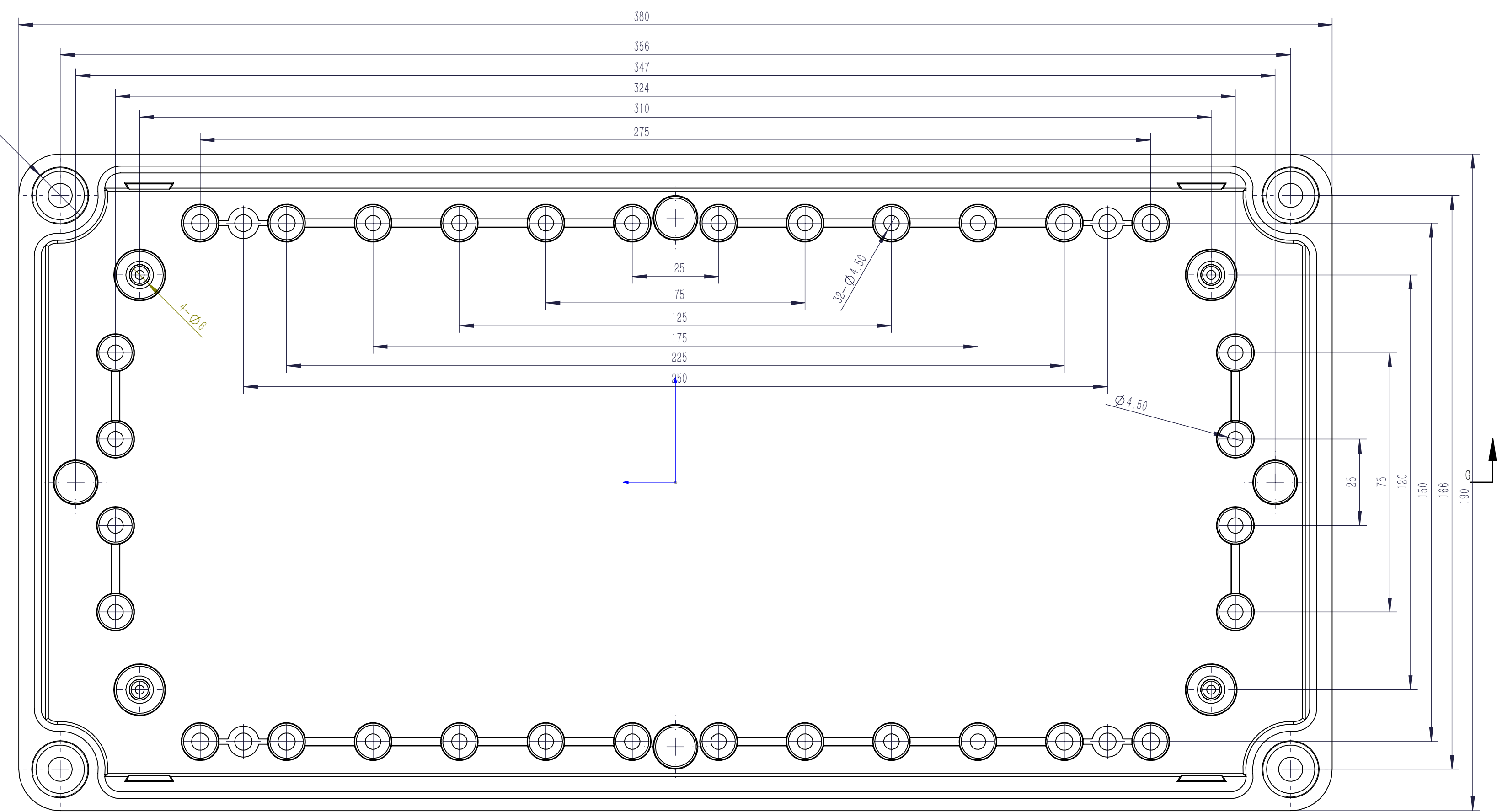

G-G

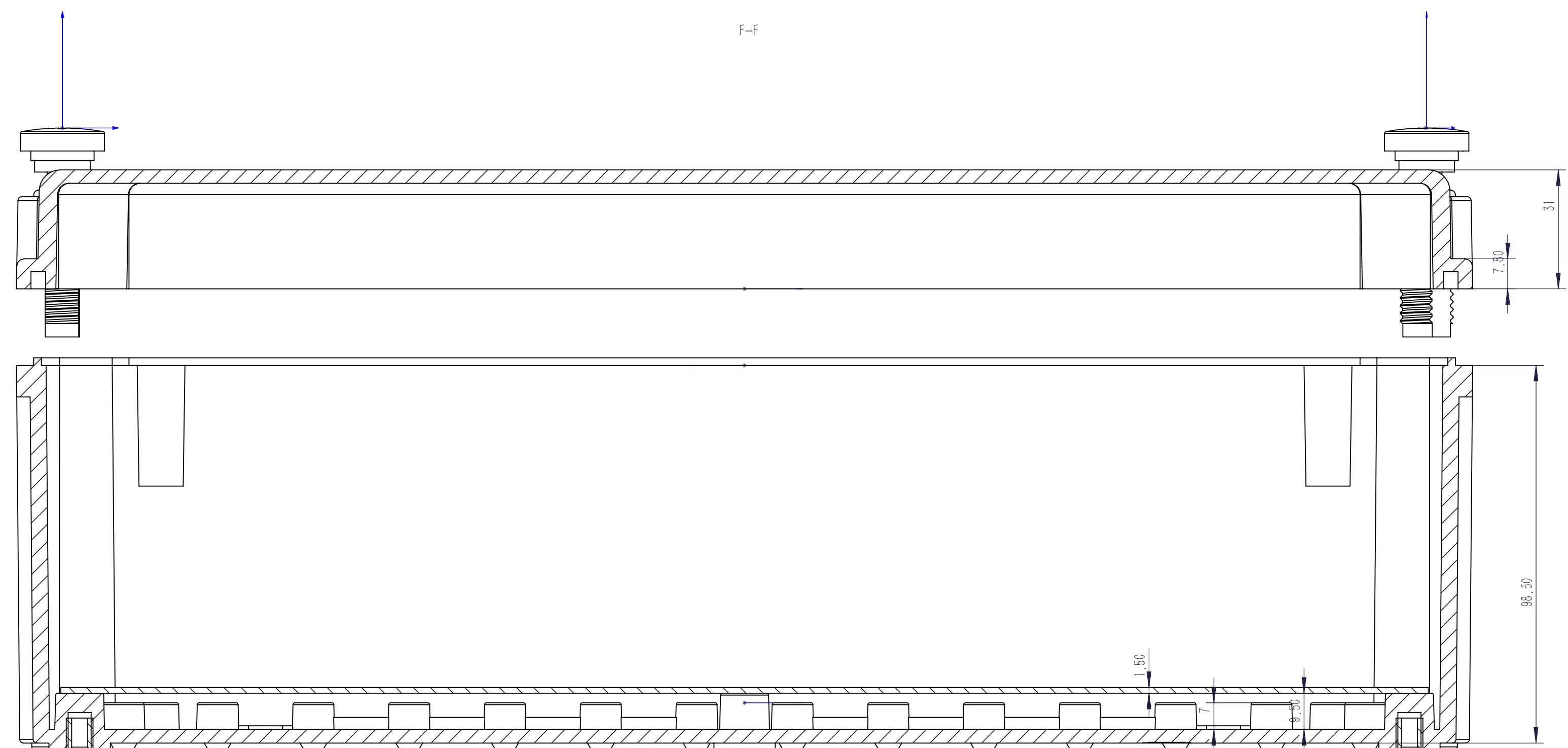
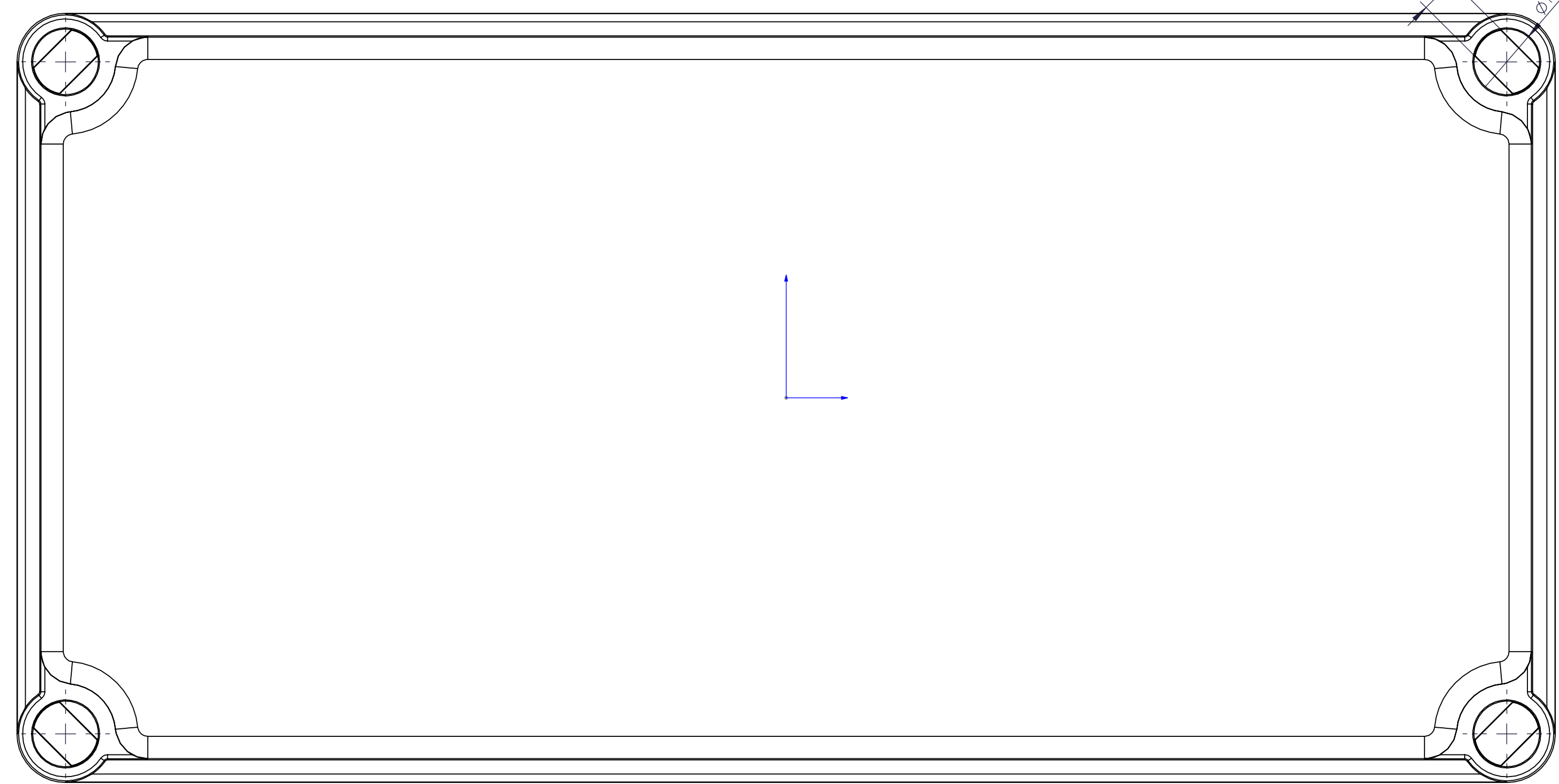
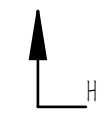
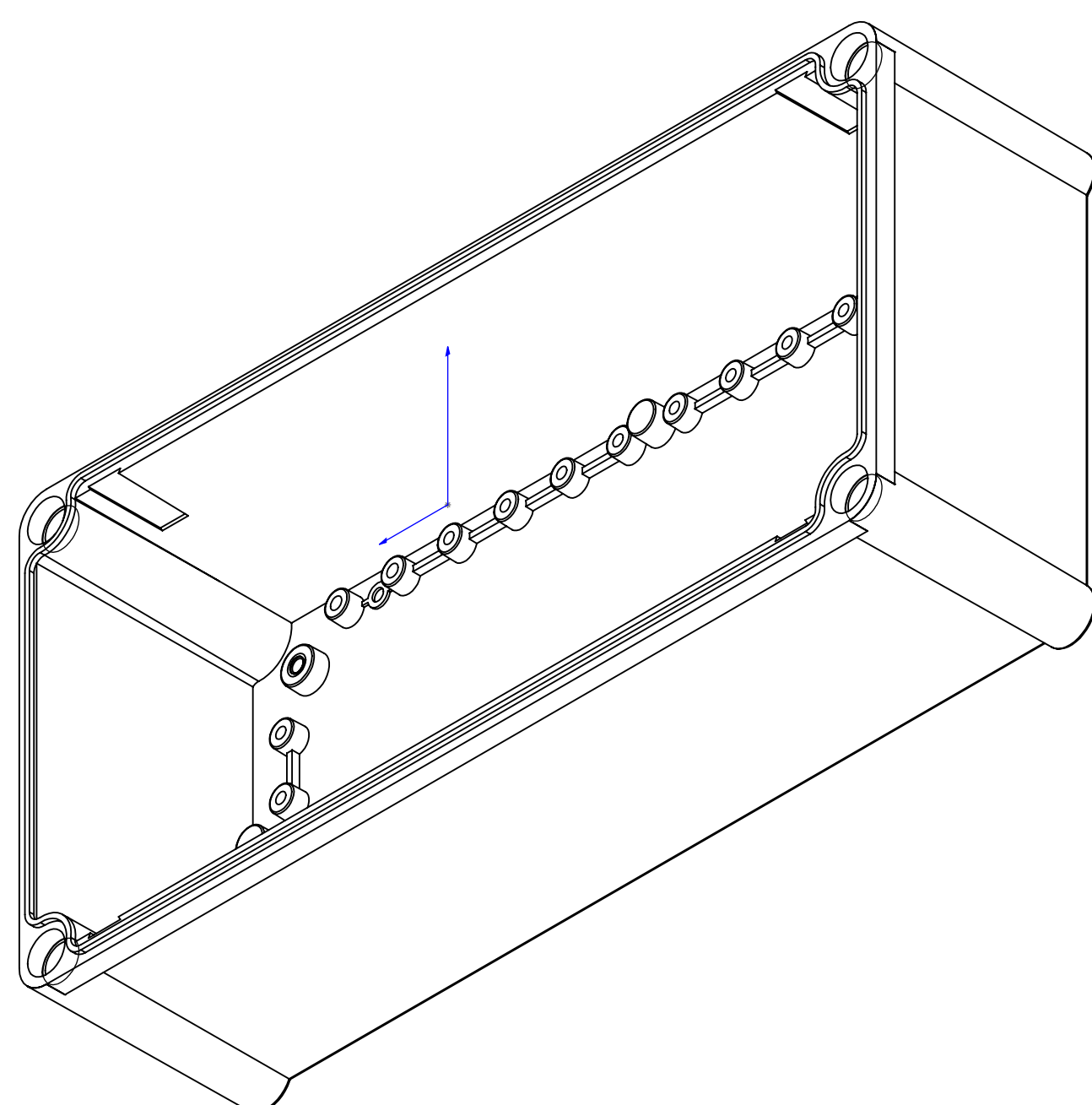
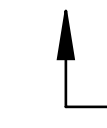
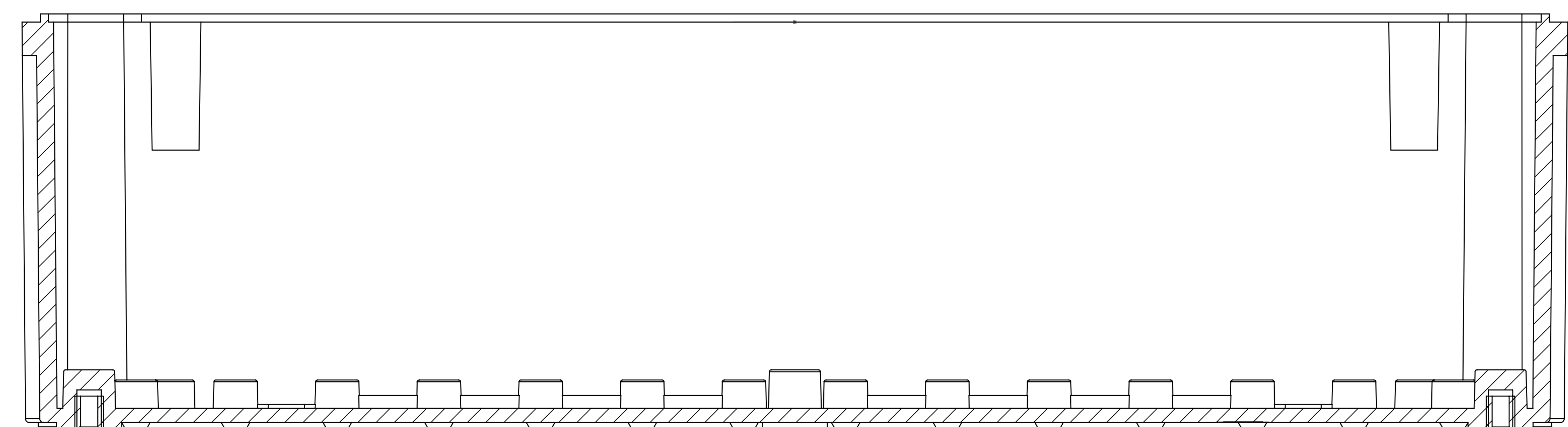

H-H

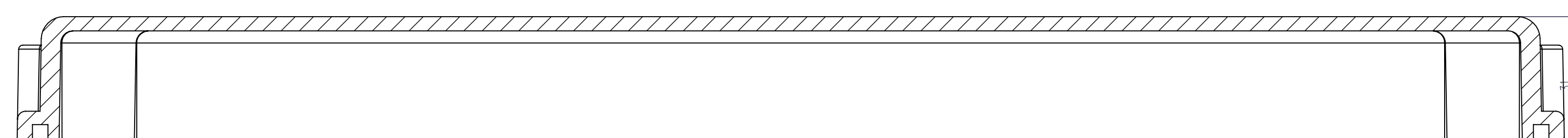

1.8

30

