

HEATED TOWEL RAIL VERTICAL RAIL

WARNING (read before installation)

Arova heated towel rails must be installed by a licensed electrician and in accordance with current local regulations. For safety, this appliance must be installed so that the bottom rail is **at least 600mm above the floor** and with **300mm clearance from permanent fixtures**, and site well away from curtains and fabrics.

Switch off the electrical supply at the mains before installation and maintenance. Consult with a licensed electrician to confirm appropriate compliant installation location. Ensure the heated towel rail is connected to an RCD protected circuit.

Adhere to wiring rules and IP ratings when placing your rail. The product is rated IP55 and suitable for indoor use only. It is suitable for bathroom and other dry areas. The appliance is not suitable for above baths, saunas, steam rooms or shower cubicles or any other damp or conductive surfaces.

This appliance can be hot to the touch during and after operation. The appliance is not intended for use by or near young children or persons with reduced physical, sensory or mental capacities or lack of experience and knowledge. Any rise in ambient temperature is directly reflected in the appliance, and as a result of this, the appliance will feel hotter to the touch during warmer periods. The insulation effect of towel will also cause the operation temperature to increase slightly.

The heated towel rails are designed to gently warm towels only. For safety, please DO NOT use for any purpose other than as a towel rail and a towel warmer. To avoid damage DO NOT sit, stand, lean or hang on product. To avoid a hazard this heated towel rail must not be used to carry towels or any other articles that have been in contact with oil, petroleum-based products or dry-cleaning fluids. And do not immerse in any liquid.













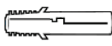



OPERATION INSTRUCTIONS

The heated towel rails in this guide are electric and feature a dry element. They are designed for efficiency with low wattage, ensuring rapid heating. The appliance will be warm in just 5-10 minutes. Without a towel, the rail's standard operating temperature stands at 38-45°C. Upon draping a towel, the temperature goes to 52-55°C. While the rail achieves its peak temperature in around 30 minutes, drying a towel might take between 3-4 hours. This duration can vary based on room temperatures, rail size, towel count, and towel moisture. This appliance is designed to gently warm and dry towels and are not purposed as primary towel dryer or room heater.

PLAN & MEASUREMENT (before installation)

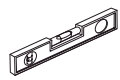
Heated towel rails may be fixed to any type of wall, masonry, timber stud or steel stud. Stud walls require timber noggins at the correct position for the wiring connection leg. If the precise position can't be determined early in the job, consider noggins with 18mm construction ply, covering a large area. Fixing into plasterboard or cement sheeting alone is not recommended.

This appliance is designed for concealed wiring installation only, please measure carefully and put the towel rail to your desired position as the electrical supply is through either of the bottom bracket arms.

<p>Check you've got everything:</p> <p>① Single vertical bar rail Screw kit including:</p>  <p>② Wired Leg x 1</p>  <p>③ Non-Wired Leg x 1</p>  <p>④ Hook x 1</p>		<p>⑤  Wall plug x 2</p> <p>⑦  Wired Mounting Bracket x 1</p> <p>⑧  Non-wired Mounting Bracket x 1</p> <p>⑪  Machine Screw x 2 (1 Spare)</p>	<p>⑥  Countersunk Screw x 2</p> <p>⑨  Grub Screws x 7 (3 Spares)</p> <p>⑩  Hook Screws x 2 (1 Spare)</p> <p>⑫  Allen Key x1</p> <p>⑬  Hook Allen Key x1</p>	<p>You will also need:</p>  Pencil  Tape Measure  Spirit Level  Safety Glasses  Drill & Bits 6mm&12mm  Screwdriver
---	--	---	--	--

INSTALLATION

1. Switch off the mains power

This appliance is installed to the 240V mains electrical circuit. To ensure your safety and to protect the towel rail, switch off the mains power before installation.

2. Fix Mounting Brackets

- Use the rail to mark centre fixing points on the wall. Ensure fixing points are plumb/ straight.
- Drill a hole for the screws and an extra hole for the cable at wiring point. Fixing two mounting brackets in place.

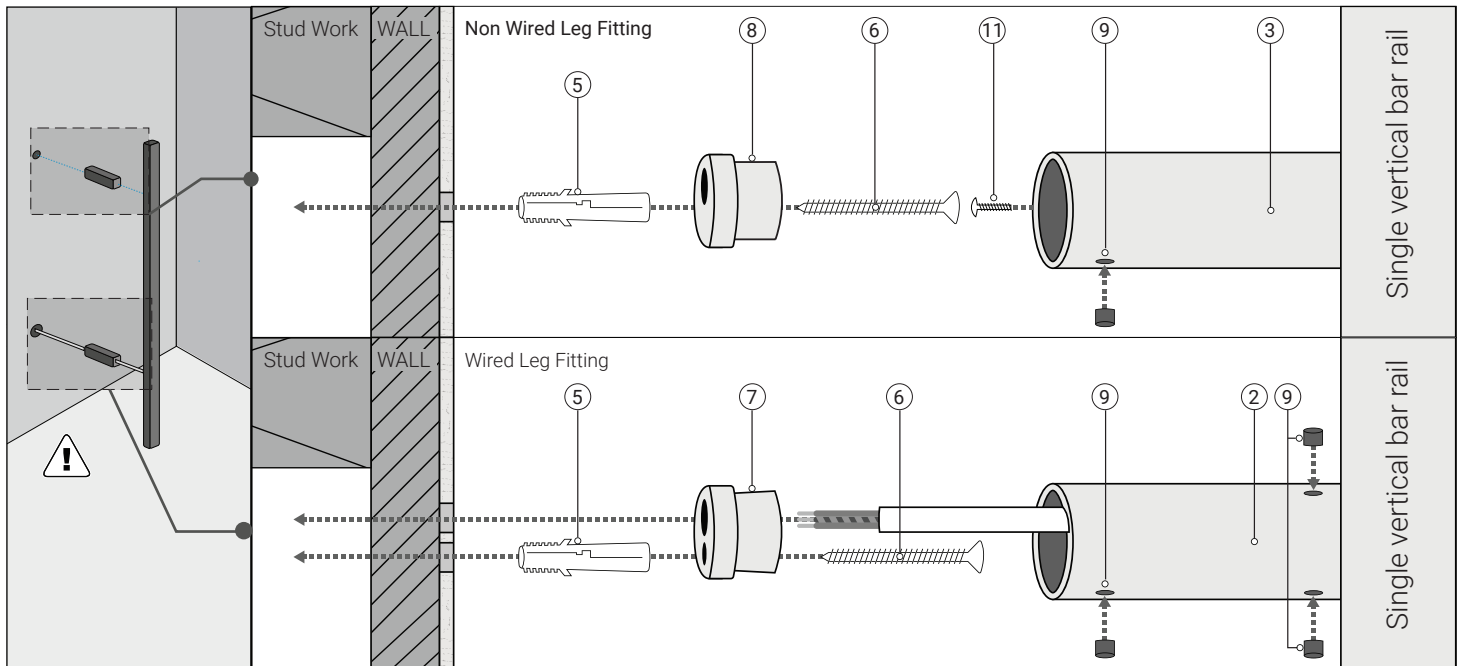

3. Fix Robe Hook (optional)

Slide the hook over the top of the vertical bar to your designed position, ensuring the grub screw hole is facing the wall.

4. Electrical Connections

- Remove the leg where the electrical supply is connected.
- Connect the power cable to the towel rail, ensuring the pins matching up correctly and then tighten the screw cap.
- Slide the exposed/concealed wiring leg over the electrical cable and fix the leg in place using the small machine screws and a Phillips screwdriver.

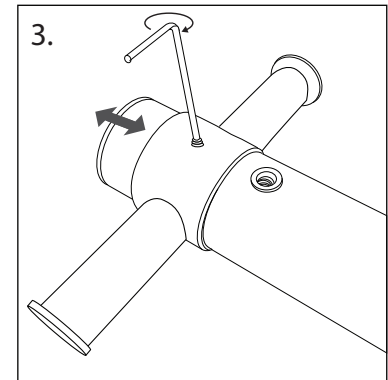

5. Fix the hook to the vertical bar

Please note that the hook is optional and is not necessary for the unit to operate.

Slide the hook on the top of the vertical bar (ensuring that the small screw hole is facing towards the wall) and hold in desired position. Use the small machine screw to fix in position.

6. Fix the heated towel rail to the wall

Fit the heated towel rail to the mounting brackets installed on the wall. You may need assistance to hold the rail in place.

CARE & MAINTENANCE

Wiping with a soft cloth and a mild cleaning detergent. Damages caused by an improper treatment is not covered by the product warranty.

WARRANTY

Please refer to our Warranty Terms on <https://www.arova.com.au/pages/warranty>