

CLIO Wall Mixer with Spout – In Wall Body Kit

IMPORTANT! Read before installation!

! In-wall body kit & Trim kits are supplied in separate boxes. For Trim kit installation, follow the instructions supplied with the suitable Trim kit.

! The front face of the mounting plate or noggin must be parallel to the finished wall/ tile face.

! The centreline through the wall mixer & outlet spigot must be horizontal to ensure that the cover plate from the trim kit is square and aligns with the finished wall tile grout lines.

! Brazed connections should NOT be made directly onto the mixer, as excessive heat will cause permanent damage

! All pipework must be thoroughly flushed prior to installation.

! Sealant/ waterproofing materials used to seal the wall penetration must not interfere with the removal of the protective sleeve and installation of the trim components.

! To avoid damaging the product, do not remove the protective sleeves until installing the trim kit.



Hot and cold water inlet pressures must be equal. Static inlet pressure: 150-1000 kPa

New Regulation: 500 kPa maximum static pressure at any outlet within a building. (AS/NZS 3500.1)



Maximum hot water temperature: 55°C.

Installation

1. Secure mixer in wall body onto a suitable noggin in the wall. When facing the mixers, the connections should be as follows:

Hot water inlet ('H') below the mixer cartridge
Cold Water Inlet ('C') to the right of mixer cartridge
Mixed Water Outlet to the left of mixer cartridge

2. Check all connections for leaks and tap for operation. Leave the protective sleeve on until installing the trim kit.
3. Seal the wall penetration between the noggin and the mixer in accordance with AS:3740. Sealant must remain clear of the protective sleeves and the surface it protects.

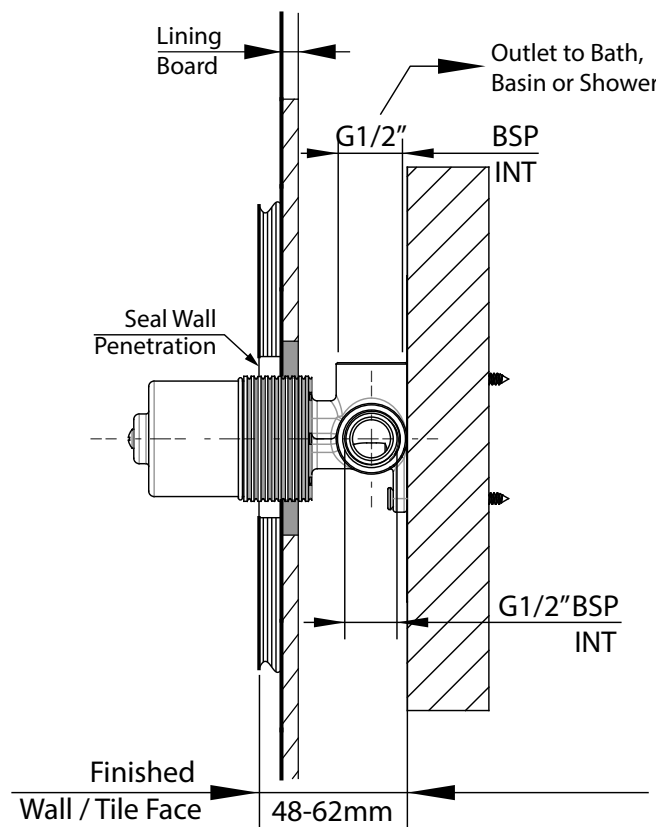

CLIO Mixer with Spout - Trim Kit

IMPORTANT! Read before installation!

! Trim Kit and In-wall Body Kit are supplied in separate boxes. In wall body must be installed at rough-in stage. For body kit installation, follow the instructions supplied with the suitable body kit.

! Trim kit items are changeable to the different trim kit colour finishes available.

! Sealant/ waterproofing materials used to seal the wall penetration must not interfere with the removal of the protective sleeve and installation of the trim components.

Replacing Cartridge

1. Turn off main water supply.
2. Remove indicator plug and use allen key to loosen grub screw to remove handle. Unscrew cap and take out trim sleeve. Taking care not to damage the decorative finish.
3. Unscrew the nut and take out old cartridge.
4. Ensure inside face of mixer body is clean. Fit new cartridge into mixer body, taking care that two lugs on base of cartridge fit into mating holes in the in the mixer body.
5. Tighten the nut to a torque of 10 Nm.
6. Repeat steps 3-6 of the installation.
7. Turn on water supply and check operation.

Installation

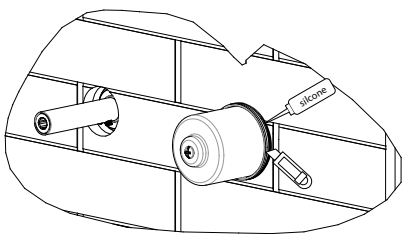

1. Seal the wall penetration between the body kit and the lining board and tiles in accordance with AS:3740 & then cut off any fitting sleeve extending out of the wall/ tile face.

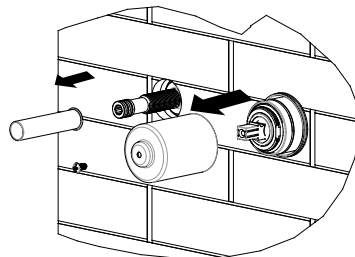

2. Remove white protective sleeve from mixer body.

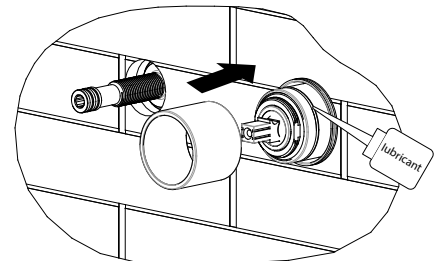

3. Ensure the surface of the mixer body is clean, apply lubricant on the O-ring, then slide trim sleeve (with WaterMark underneath) over mixer body and push it in.

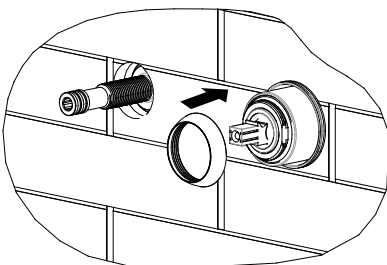

4. Screw cap onto the thread of nut and hand tighten to secure the trim sleeve.

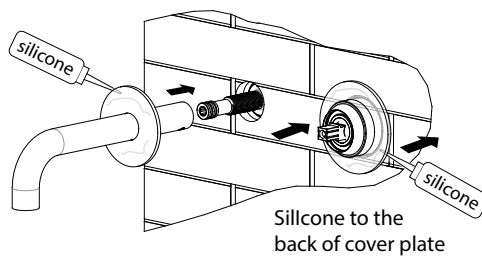

5a.

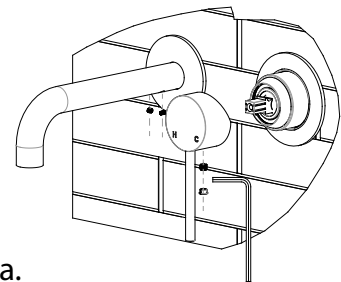

6a.

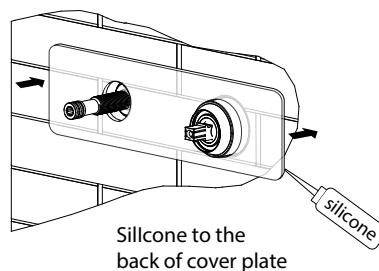

5b.

5. Apply suitable sealant to the back edge of the cover plate and push the cover plate firmly against the wall/ tile face. Wipe off excess sealant.

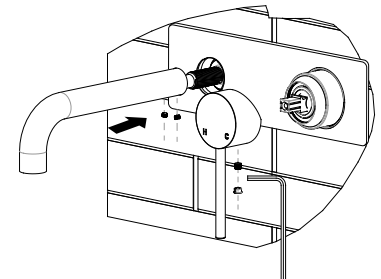

6b.

6. Fit handle on, taking care that it is pushed fully onto the cartridge stem, then tighten grub screw. Fit the indicator plug in. Taking care not to damage the decorative finish.