

# Control valve(3/2way)

## S3 Series



### Symbol



### Product feature

1. The external force required by changing the direction of the series of S3B, S3R, S3L and S3V is provided by external mechanism, which can be used for position test or stroke switch.
2. The series of S3PF, S3PM, S3PP, S3PL, S3Y, S3HS, S3C and S3D are operated manually, owning control joints with several structure forms and suitable for application under different conditions.
3. Shut-off structure has good tightness and is sensitive in direction changing and lubricant is not necessary.
4. Multi-mounting makes it convenient to install and apply.
5. The control joints of series of S3C, S3D, S3Y, S3R and S3L are made of metal which has long service life and more reliable and steady performance.

### Inner structure

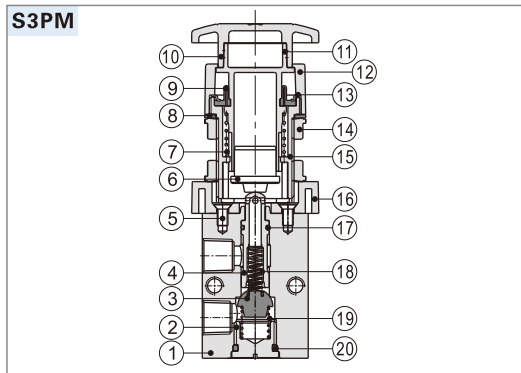

No.	Item	No.	Item	No.	Item
1	Body	8	Clamping gasket	15	Button body
2	Bottom cover	9	Dust cover	16	Connector
3	Stopper plug	10	Button cap	17	O-ring
4	Valve core	11	Main body of button	18	Spring
5	Screw	12	Top cover	19	Spring
6	Button pressing buckle	13	Button ring	20	O-ring
7	Spring	14	Clamping nut		

### Specification

Model	S3B	S3C	S3D	S3V	S3R	S3L	S3Y	S3PM	S3PP	S3PF	S3PL	S3HS
Fluid	Air (to be filtered by 40 μm filter element)											
Operating	External control direct acting type											
Port size [Note1]	M5:M5 06:1/8" 08:1/4"											
Orifice size	M5:2.5 mm <sup>2</sup> (Cv=0.14) 06:8.0mm <sup>2</sup> (Cv=0.45) 08:12.0mm <sup>2</sup> (Cv=0.67)											
Valve type	3/2 Way											
Lubrication [Note2]	Not required											
Pressure range	0~1.0MPa(0~145psi)											
Proof pressure	1.5MPa(215psi)											
Temperature °C	-20~70											
Material of body	Aluminum alloy											

[Note1] G thread is available.

[Note2] Once lubricated air is used, continue with same medium to optimise valve life span. It is suggested to use ISO VG32 lubricant or the oil with the same grade.

### Reversal stroke

Unit: mm

Type	Spool stroke	Button stroke	Type	Spool stroke	Roller(handle) stroke
S3B	2.4~4.0	—	S3R	2.4~3.4	5.5~7.8
S3PF	2.4~4.0	3.8~5.4	S3L	2.4~3.4	6.0~8.6
S3PP	2.4~4.0	3.8~5.4	S3V	2.4~3.8	3.4~4.8
S3PM	2.4~4.0	3.8~5.4	S3C	2.4~3.8	14.4~18.4
S3PL	2.4~4.0	5.9~7.5	S3D	2.4~3.8	7.4~9.4
S3HS	2.4~4.0	5.1~6.7			

### Ordering code

S3 PM 06 R G					
① Valve's type	② Model	③ Port size	④ Button color	⑤ Thread type	
S3: S type 3/2 Way	B: Basic type	M5:M5 06:1/8" 08:1/4"	No this code	M5	G: G Thread
	C: Long handle type			1/8" 1/4"	
	D: Short handle type				
	Y: Lever type				
	R: Roller type				
	L: Roller with free return type				
	V: Vertical type				
	PL: Latching type				
	PP: Protruding type				
	PF: Flat type				
PM: Mushroom type		Blank: Red			
HS: Selector type		R: Red G: Green B: Black			

### Flow chart

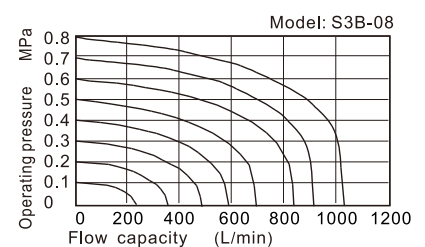
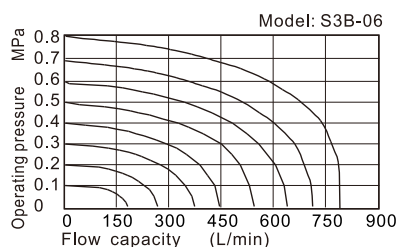
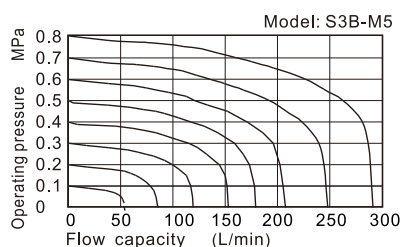

## S3 Series

### Installation and Application

- 1) The control set is made of engineering plastic which only allows manual operation and switching valves through metal impact is forbidden.
- 2) The series of S3B, S3C, S3D, S3PM, S3PF and S3PP get the function of automatic restoration. The hand valves of S3Y, S3HS and S3PL are in the type of manual restoration. S3PL will be restored by turning the revolve button after being pressed into orientation.
- 3) Pay attention to the reversing stroke. The reversing stroke can not surpass its stroke stipulated in stroke control table when the direction-change of the valve is forced by any external forces, otherwise it will cause the damage of the valve.
- 4) The S3L can only switch the valve in single direction (impact from right to left). The impact from the other direction is invalid (from left to right).
- 5) Control joint combination can be ordered individually. Please refer to the following tables for order details.

#### Fixation way of body

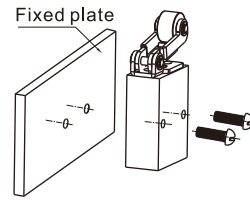

#### Fixation way of panel

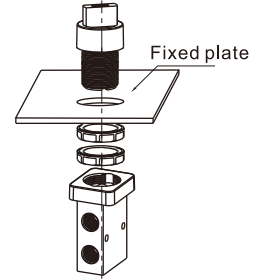

### Dimension

#### Body(S3B)

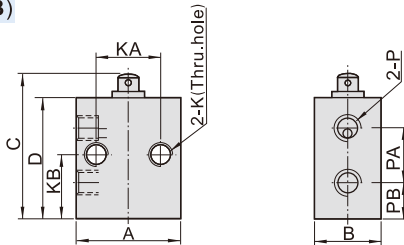

Model\Item	A	B	C	D	K	KA	KB	P	PA	PB
M5	26	16.5	36	30	M5x0.8	16	15	M5x0.8	13	9
06	30	16.5	47	41	M5x0.8	23	20.5	1/8"	17.5	11.5
08	34	17.5	52	46	M5x0.8	24	22.5	1/4"	21	12

#### Lever type(Y)

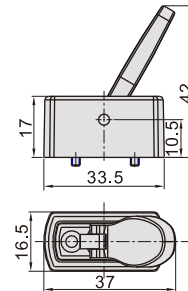

Model		Lever type(Y)
How to order	Ordering code	M3Y210-P13A
	Type	M3Y210Lever type control set
Applicable products		S3YM5,S3Y06,S3Y08

#### Short handle type(D)

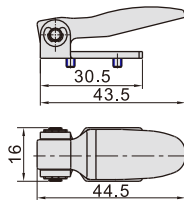

Model		Short handle type(D)
How to order	Ordering code	M3D210-P13A
	Type	M3D210 Short handle type control set
Applicable products		S3DM5,S3D06,S3D08

#### Long handle type(C)

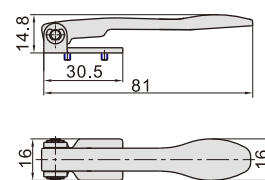

Model		Long handle type(C)
How to order	Ordering code	M3C210-P13A
	Type	M3C210 Long handle type control set
Applicable products		S3CM5,S3C06,S3C08

#### Roller type(R)

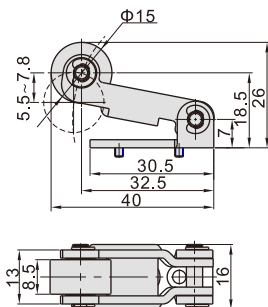

Model		Roller type(R)
How to order	Ordering code	M3R210-P14A
	Type	M3R210 Roller type control set
Applicable products		S3RM5,S3R06,S3R08

#### Roller with free return type(L)

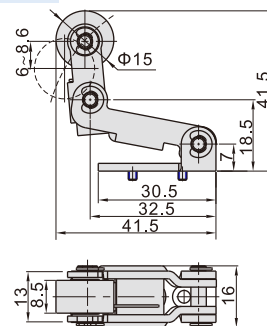

Model		Roller with free return type(L)
How to order	Ordering code	M3L210-P14A
	Type	M3L210 Roller with free return type control set
Applicable products		S3LM5,S3L06,S3L08

# Control valve(3/2way)

## S3 Series

### Vertical type(V)

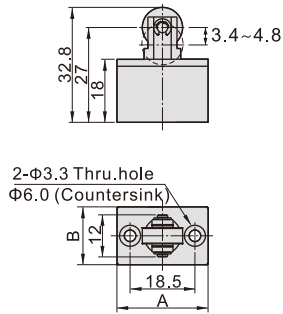

Model	Vertical type ( V )	
How to order	Ordering code	S3V05(06/08)-P14A
	Type	S3VM5(06. 08) Vertical type control set
	Applicable products	S3VM5,S3V06,S3V08
Model\Item	A	B
M5	26	16.5
06	30	16.5
08	34	17.5

### Protruding type(PP)

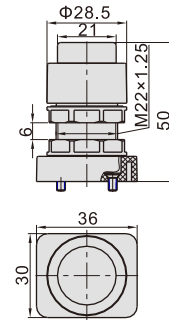

Model	Protruding type(PP)	
How to order	Ordering code	S3PP05-P11A
	Type	S3PP protruding type control set (Green)
	Ordering code	S3PP05-P12A
	Type	S3PP protruding type control set (Red)
	Ordering code	S3PP05-P13A
	Type	S3PP protruding type control set (Black)
	Applicable products	S3PPM5,S3PP06,S3PP08

### Mushroom type(PM)

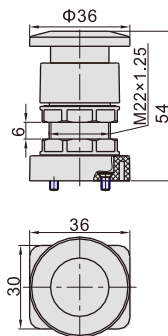

Model	Mushroom type(PM)	
How to order	Ordering code	S3PM05-P11A
	Type	S3PM mushroom type control set (Green)
	Ordering code	S3PM05-P12A
	Type	S3PM mushroom type control set (Red)
	Ordering code	S3PM05-P13A
	Type	S3PM mushroom type control set (Black)
	Applicable products	S3PMM5,S3PM06,S3PM08

### Latching type(PL)

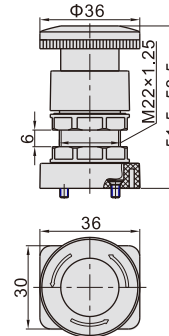

Model	Latching type (only red)(PL)	
How to order	Ordering code	S3PL05-P12A
	Type	S3PL Latching type control set (Red)
	Applicable products	S3PLM5,S3PL06,S3PL08

### Flat type(PF)

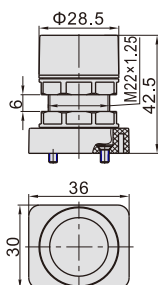

Model	Flat type(PF)	
How to order	Ordering code	S3PF05-P11A
	Type	S3PF flat type control set (Green)
	Ordering code	S3PF05-P12A
	Type	S3PF flat type control set (Red)
	Ordering code	S3PF05-P13A
	Type	S3PF flat type control set (Black)
	Applicable products	S3PFM5,S3PF06,S3PF08

### Selector type(HS)

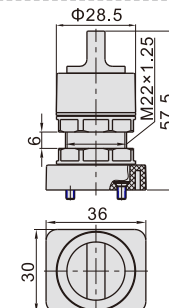

Model	Selector type(HS)	
How to order	Ordering code	S3HS05-P11A
	Type	S3HS selector type control set (Green)
	Ordering code	S3HS05-P12A
	Type	S3HS selector type control set (Red)
	Ordering code	S3HS05-P13A
	Type	S3HS selector type control set (Black)
	Applicable products	S3HSM5,S3HS06,S3HS08