

Miniature Intermediate Power Relay

HYE

- 10A Switching Capability
- 2kV dielectric strength (between coil and contacts)
- Plug-in or PCB mountable
- Different Sockets Available
- RoHS Compliant
- 2 to 4 pole configurations
- Outline Dimensions: 28.0 x 21.3 x 35.2mm



Options & Ordering Codes

HYE	4	1	PN	24VDC
Contact Arrangement				Coil Voltage
2 Pole CO	2			
3 Pole CO	3			
4 Pole CO	4			
Termination				
Plug-In		1	PN	Mechanical indicator /test latch LED
PCB		2	XX	No indication



Contact Data		
Contact Arrangement	2P / 3P	4P
Contact Resistance	50mΩ (at 1A 24VDC)	
Contact Material	AgSnO ₂	
Contact Rating	10A 250VAC/30 VDC	5A 250VAC/30 VDC
Max. Switching Voltage	250VAC / 30VDC	
Max. Switching Current	10A	5A
Max. Switching Power	2500VA / 300W	1250 VA / 150 W
Mechanical Life	1x10 ⁷ OPS	
Electrical Life	1x10 ⁵ OPS	

Characteristics		
Initial Insulation Resistance	1000MΩ (at 500VDC)	
Dielectric Strength	Between coil & contacts	1500VAC 1min
	Between open contacts	1000VAC 1min
	Between contact sets	1500VAC 1min
Operate Time (at nominal voltage)	25ms max.	
Release Time (at nominal voltage)	25ms max.	
Shock Resistance	Functional	100m/s ²
	Destructive	1000m/s ²
Vibration Resistance	10 to 55Hz 1.5mm DA	
Ambient Temperature	-40°C to +70°C	
Humidity	98% RH, +40°C	
Termination	8 Pin	PCB, Plug-In
Unit Weight	Approx 37g	
Construction	Dust Protected	

Coil		
Coil Power	DC Type	900mW
	AC Type	1.2VA

Coil Data at 23°C			
Nominal Voltage VDC	Pick-Up Voltage VDC	Drop-Out Voltage VDC	Coil Resistance Ω
6	4.8	0.6	40 (1±10%)
12	9.6	1.2	160 (1±10%)
24	19.2	2.4	650 (1±10%)
48	38.4	4.8	2600 (1±10%)
110	88.0	11.0	11000 (1±10%)

Nominal Voltage VAC	Pick-Up Voltage VAC	Drop-Out Voltage VAC	Coil Resistance Ω
6	4.8	1.8	12 (1±10%)
12	9.6	3.6	46 (1±10%)
24	19.2	7.2	180 (1±10%)
48	38.4	14.4	780 (1±10%)
110	80.0	30.0	3750 (1±10%)
220	160.0	60.0	12950 (1±10%)
230	176.0	66.0	18790 (1±10%)

Miniature Intermediate Power Relay HYE

2 and 3 POLES

Plug-in

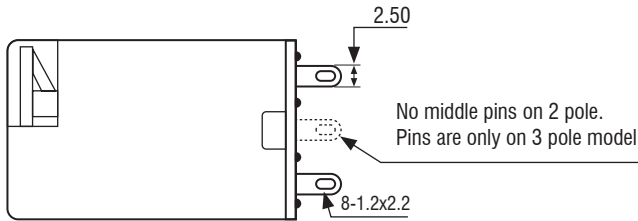

PCB

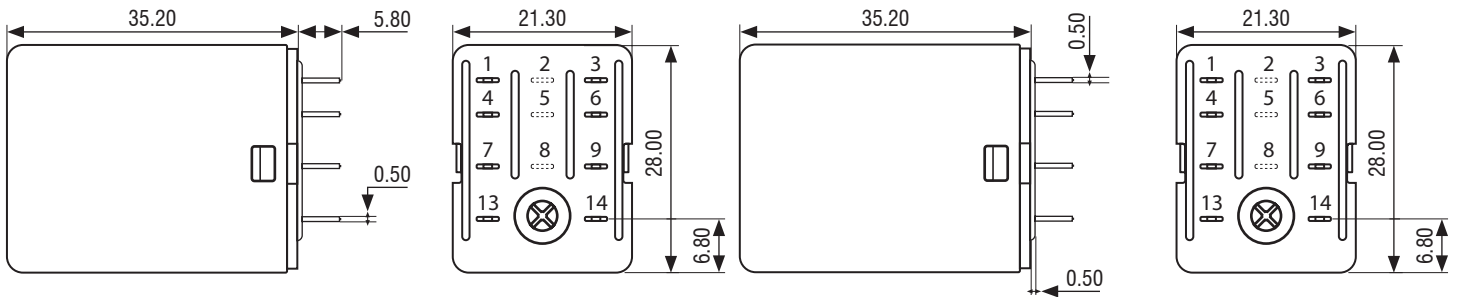
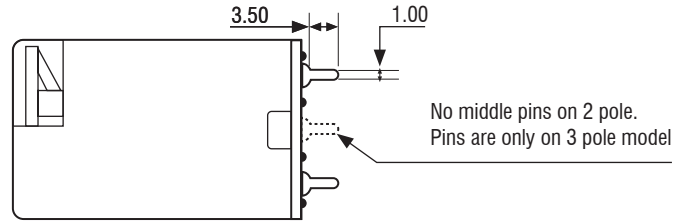

4 POLES

Plug-in

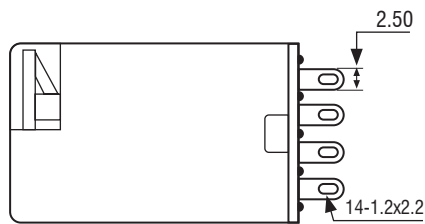

PCB

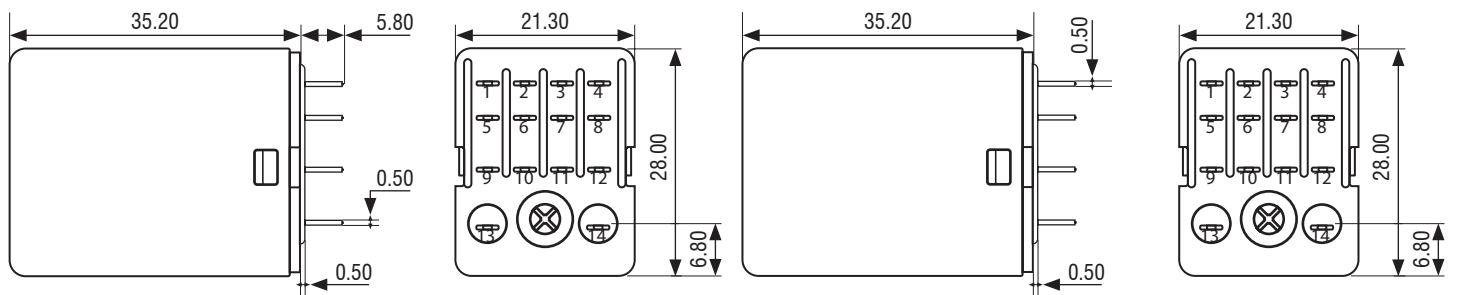
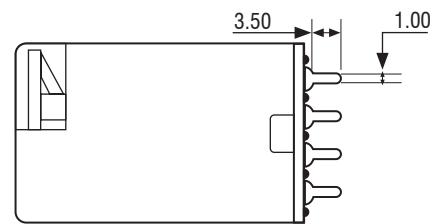

PCB LAYOUT

2 Poles CO

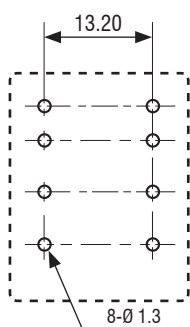

3 Poles CO

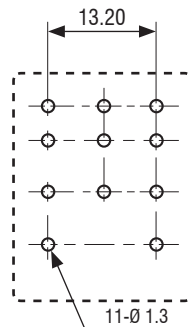

4 Poles CO

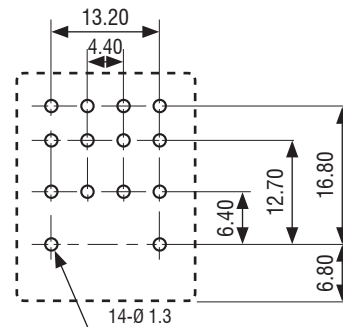

Miniature Intermediate Power Relay HYE

WIRING DIAGRAM

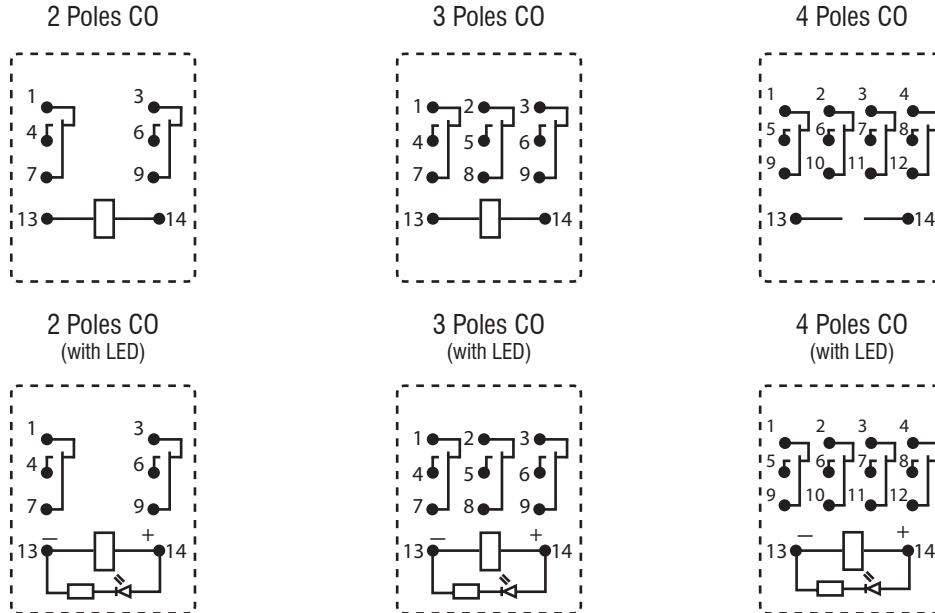

Bases - Dimensions (mm)



Relay	Base	Nominal Voltage (V)	Nominal Current (A)	Ambient Temperature	Dielectric Strength Min.	Screw Torque (Nm)	Wire Strip Length (mm)
2P	SRNE2-D	300V	10A	-25 to 85°C	2500VAC	0.6	7mm
2P	SRNE2-S	300V	10A	-25 to 85°C	2500VAC	0.6	7mm
3P	SRNE3-C	300V	10A	-25 to 85°C	2500VAC	0.6	7mm
3P	SRNE3-D	300V	10A	-25 to 85°C	2500VAC	0.6	7mm
4P	SRPE4-0	300V	10A	-25 to 85°C	2500VAC	N/A	N/A
4P	SRNE4-C	300V	10A	-25 to 85°C	2500VAC	0.6	7mm
4P	SRNE4-D	300V	10A	-25 to 85°C	2500VAC	0.6	7mm
4P	SRNE4-S	300V	10A	-25 to 85°C	2500VAC	0.6	7mm

SRNE2-D

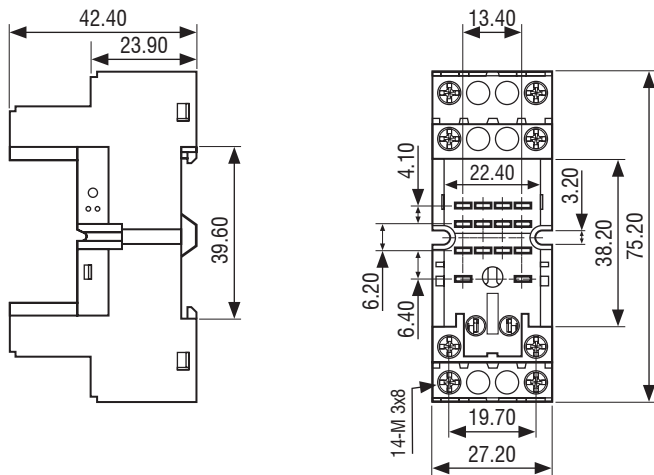

Wiring Diagram

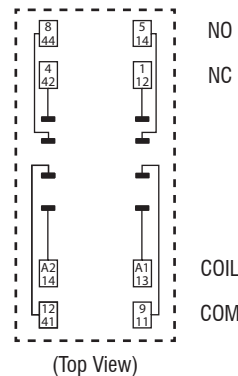

ACCESSORY
 Metallic retainer RC4-N
 Marker - SRN-BM-1
 Plug-in modules PDME1 to RPDME1

Miniature Intermediate Power Relay HYE

SRNE2-S

Wiring Diagram

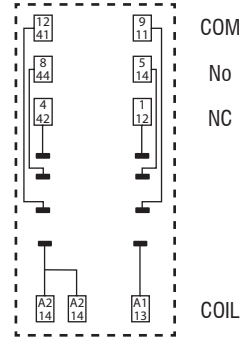
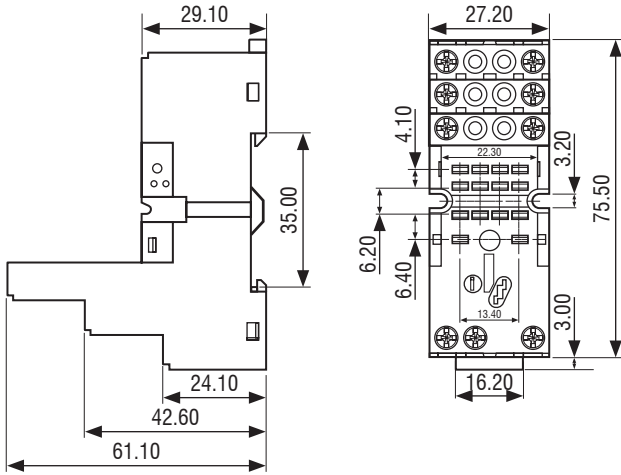

(Top View)

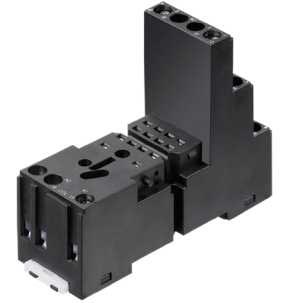

ACCESSORY

Metallic retainer RC4-N
Marker - SRN-BM-1
Plug-in modules PDME1 to RPDME1

SRNE3-C

Wiring Diagram

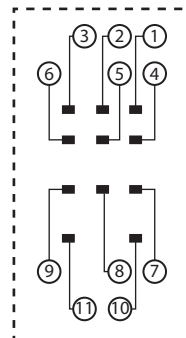
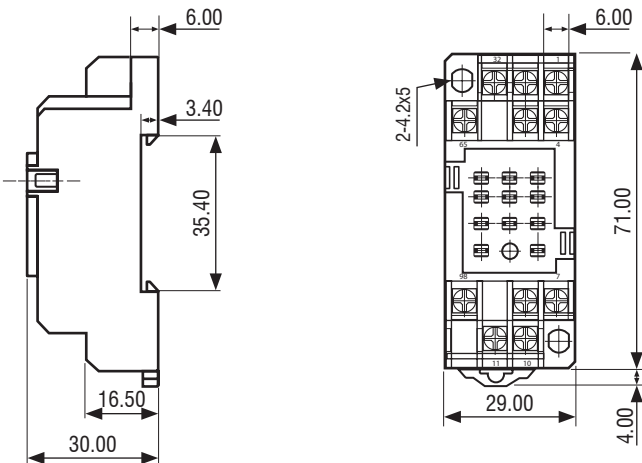

(Top View)

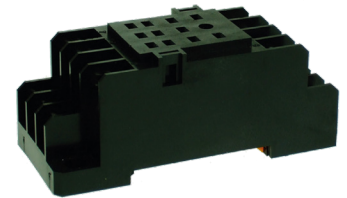

SRNE3-D

Wiring Diagram

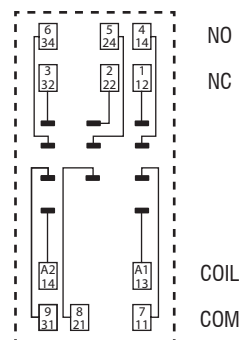
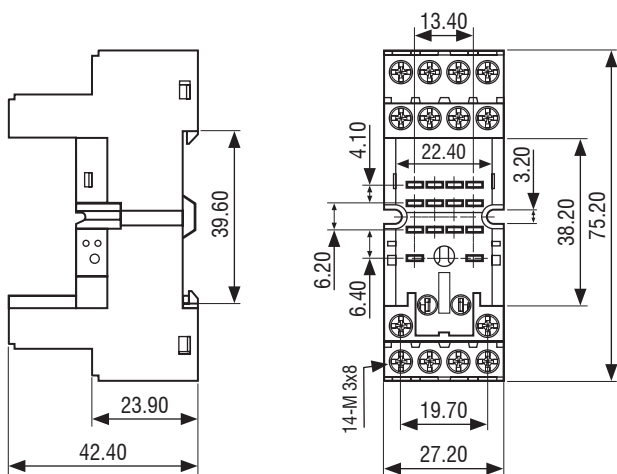

(Top View)



ACCESSORY

Metallic retainer RC4-N
Marker - SRN-BM-1
Plug-in modules PDME1 to RPDME1

Miniature Intermediate Power Relay HYE

SRPE4-0

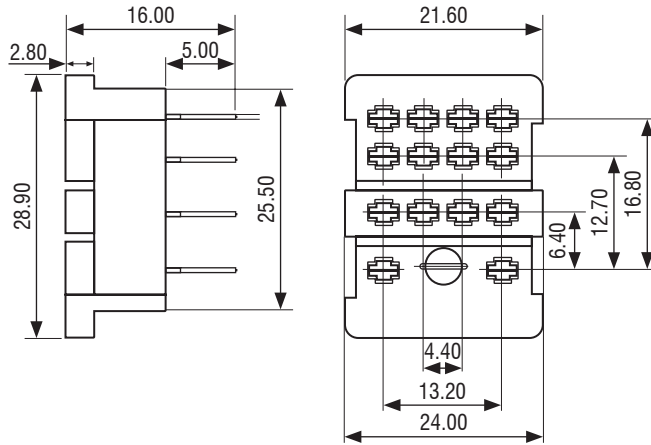

PCB Layout

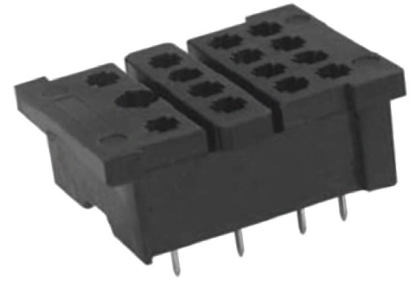
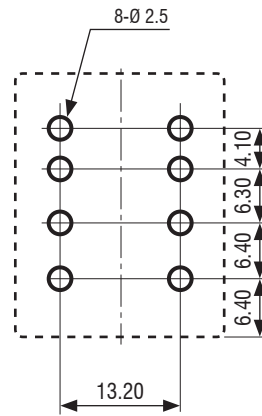

ACCESSORY
Metallic retainer SRC-CLIP

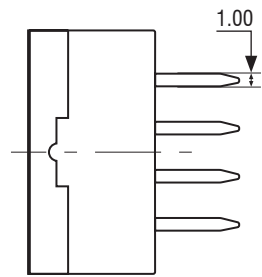

SRNE4-C

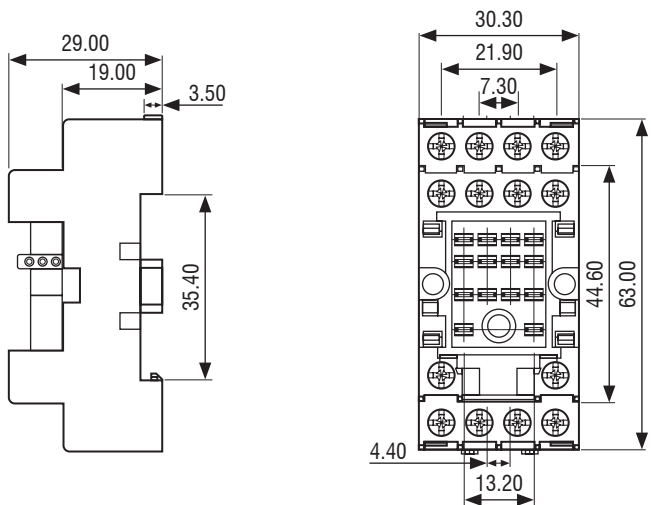

Wiring Diagram

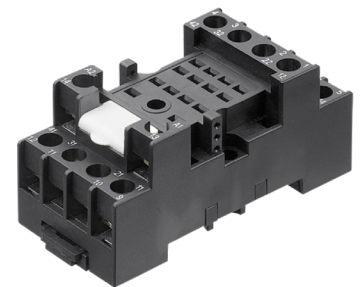
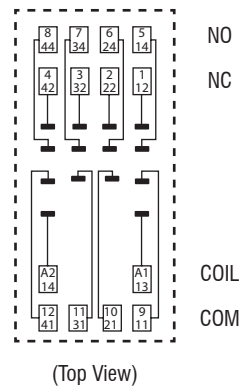

ACCESSORY
Metallic retainer RC4-N

Miniature Intermediate Power Relay HYE

SRNE4-D

Wiring Diagram

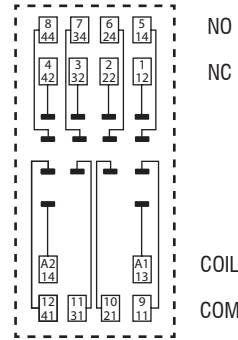
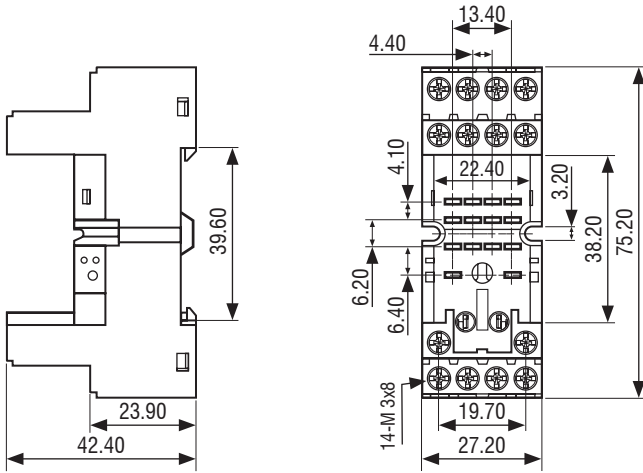

(Top View)

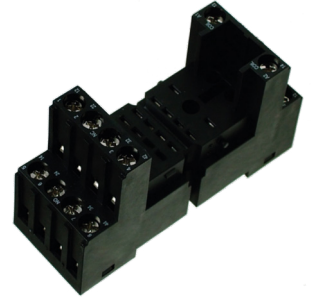

ACCESSORY

Metallic retainer RC4-N
Marker - SRN-BM-1
Plug-in modules PDME1 to RPDME1

SRNE4-S

Wiring Diagram

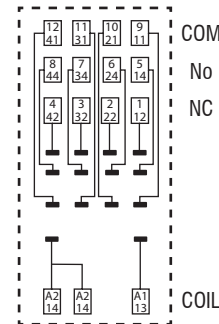
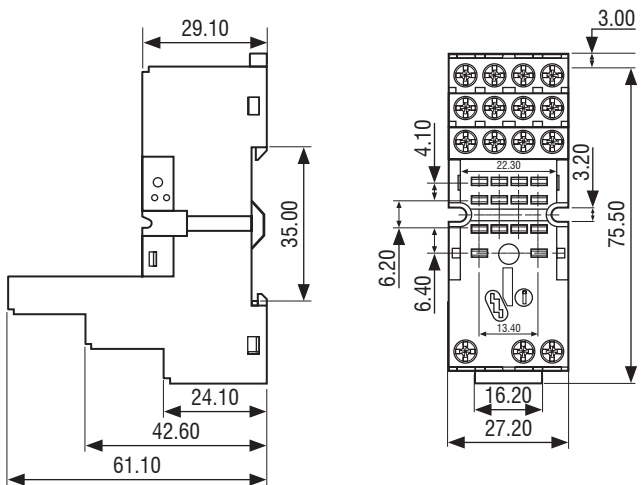

(Top View)

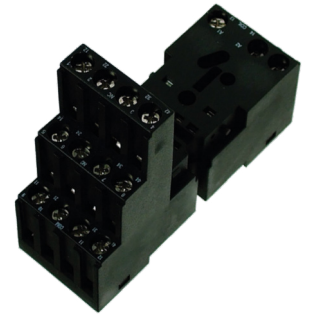

ACCESSORY

Metallic retainer RC4-N
Marker - SRN-BM-1
Plug-in modules PDME1 to RPDME1

Miniature Intermediate Power Relay HYE

DIMENSIONS OF RELATED COMPONENT

Retainers

SRC-CLIP

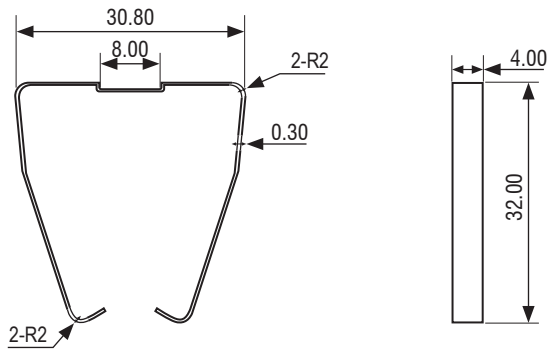

RC4-N

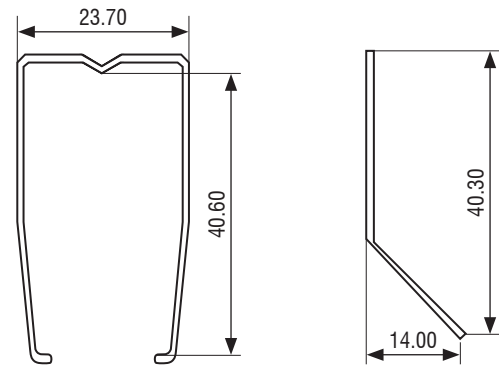

Markers

SRN-BM-1

