



ZF-201 STANDARD MODEL PORCELAIN URINAL INSTALLATION INSTRUCTIONS

Before installing your urinal, ensure:

- **There is no trap downstream of the fixture connection point**
- **The drain line is clear and free flowing**
- **There is no copper pipe drainage immediately downstream of the urinal**

1.



Install a 50mm PVC drain at 400mm to centre of pipe from FINISHED floor level. The pipe should extend 15mm through finished wall

2.

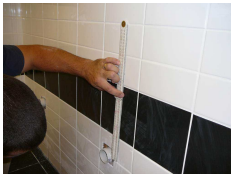

Measure 450mm from centre of waste pipe to centre of urinal bracket and mark wall.

3.



Install the wall bracket. Ensure the bracket is centred above the drain outlet and level on the wall.

4.



Connect the reducing Fernco onto the urinal and tighten, ensuring access to hose clamp after urinal is installed

5.



Carefully hang the urinal on the bracket, levering the Fernco onto the waste pipe outlet. Ensure Fernco does not become pinched

6.



Tighten the Fernco onto the 50mm PVC pipe and perform a water test by pouring a bucket of water into the urinal. Ensure water flows away freely

7.



After checking for leaks, complete installation by securing base of urinal and sealing around the bowl with sanitary grade silicone

8.



Complete installation by commissioning the unit ready for use. Follow the instructions for the commissioning of a ZeroFlush Urinal

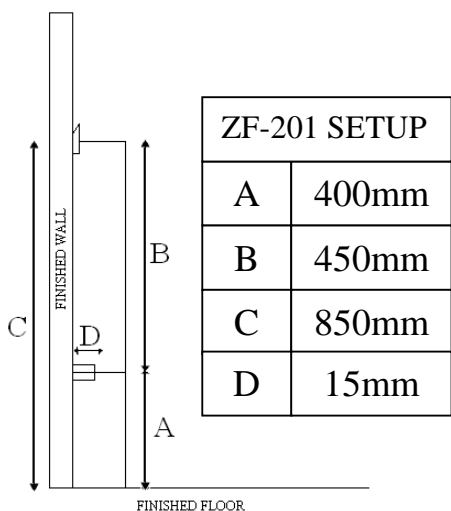

IN THIS BOX	
Trap Insert	
Fernco	
Trap Key	
Odour Barrier	
ZF-201	
Instructions	

