

Interactive Troubleshooting Guide for Frequently Seen Issues

Last Updated: 07/19/18

Ways to Navigate through the Guide

1. Select any of the images below to jump to a section.
2. Use the bookmarks to jump to a section.
3. Scroll through the pages.

Is something wrong or missing? Have suggestions?

Please contact us at ATDSupport@Ravenind.com and let us know!

Main Menu

Disclaimer:

The issues and resolutions provided in this guide do not encompass every possible issue users can experience. This guide focuses on the most common issues reported by the Raven dealer network and its end-user customer-base.

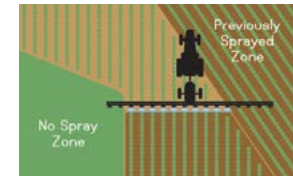

Rate



Rate Constantly Displays Zero

Rate Bounces Around

**Rate Goes Up when Speed Goes Down
(or Vice Versa)**

Note: Rate issues are usually not directly caused by the console / field computer.

Always check the following first:

- Verify all product control and machine settings (cal numbers: boom, meter, valve, etc.).
- Test the product cabling and components (valves, flow meters / encoders, speed sensors, etc.).

Review the following rate sections for information on troubleshooting “no rate” or “erratic rate” issues.

No Rate

Three Things Needed for Rate

All Raven rate control systems must have speed, boom sense, and flow. There will not be a rate without any of these three components. Each can be individually tested, but it is recommended to test them in the following order:



Boom sense (area/hour) will not register without speed, and flow will not register without boom sense.

If you can already see that there is a speed and it is correct, go straight to testing for boom sense. If you can already see that there is an area/hour, go straight to testing for flow.

No Rate - Speed

What To Check

While moving, verify on the console that the distance is counting up and that speed is present.

Is the speed source mounted correctly?

Does it have adequate power?

Verify voltages as seen in the image below.

Is the Speed Type set correctly?

- SP1 - Wheel
- SP2 - Radar, or Simulated Radar from GPS

Is the Speed Cal number correct?

$$\text{New Speed Cal} = \frac{\text{Current Speed Cal} \times \text{Measured Distance}}{\text{Distance on Controller}}$$

Speed Sensor Test

1. Enter a Speed Cal of 1000 (SP1) or 9999 (SP2).
2. Watch the distance on the console.
3. Start at the speed source. With a small jumper wire (or paper clip), short between Ground and Signal with a “short-no short” motion. Each time a contact is made, the distance should increase.
 - If distance does not increase, remove the section of cable and repeat the test at the next connector toward the console. Continue on until you find a bad cable or until you reach the back of the monitor. Replace any bad cables as required.
 - If distance does not increase, remove the section of cable and repeat the test at the next connector toward the console. Continue on until you find a bad cable or until you reach the back of the monitor. Replace any bad cables as required.

When finished, re-enter the correct Speed Cal number (using the formula above).

Note: If using GPS speed over CAN, the Speed Cal must be 1000.

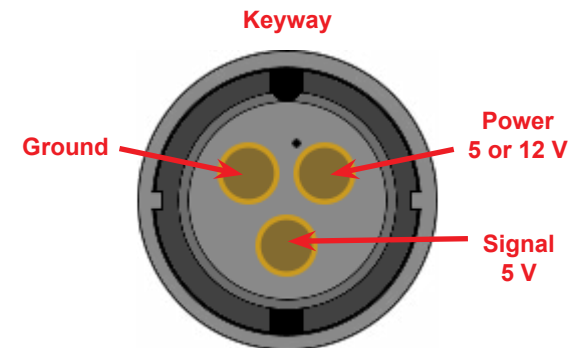

No Rate - Boom Sense

What To Check

The easiest way to test for boom sense is to check for an area/hour. First, a boom width needs to be entered in the console. With the boom switches and master switch on, and the console is showing speed, verify that there is an area/hour.

Where To Find Area/Hour

SCS Console	Area/Hour Button
Envizio Pro	Product Control > Volume/Area Settings (out of job)
Viper Pro	Product Control (out of job)
Viper 4	Must be done while in a job. Product Control Widget > More

Area/Hour Test

1. Place the system in Manual if using an SCS console.
2. Turn off the master switch and all boom switches.
3. Begin moving or set a self test speed.
4. Find the area/hour and verify that it is 0.
5. Turn on the master switch and Boom 1. You should have an area/hour.
6. Turn on Boom 2. The area/hour should increase.

No Area/Hour

If an area/hour does not register for any of the boom sections, testing for boom sense voltage will be necessary. However, given the different forms of boom sense/speed nodes available (Boom Speed node, Switch Pro, Product Controller, etc.), testing will not be the same for every form of boom sense. Use the Knowledge article below for more information on testing boom sense.

[How to Test for Boom Sense](#)

No Rate - Flow

What To Check

To verify there is flow, the console needs to have speed and boom sense. If both are present, look at the volume/minute. This will verify the console is receiving a signal from the flow meter / encoder.

Is the flow meter / encoder mounted correctly?

Does it have adequate power?

Verify voltages as seen in the image below.

Is its operating range within the target rate?

Is the calibration number correct?

$$\text{New Meter Cal} = \frac{\text{Current Meter Cal} \times \text{Total Volume (Controller)}}{\text{Actual Measured Volume}}$$

- Liquid - Meter Cal

- Granular - Spreader Constant

$$\text{Spreader Constant} = \text{Encoder Count} / \frac{D \times GH \times GW}{1728}$$

D Distance belt travels per 1 revolution of the encoder
GH Gate Height
GW Gate Width

Flow Meter / Encoder Test

1. Enter a Meter Cal of 1 if doing liquid, or a Density of 1 and a Spreader Constant of 0 if doing granular.
2. Place the system in Manual if using an SCS console.
3. Zero out the total volume on the console.
4. Turn at least one boom section to the “ON” position as well as the master switch.
 - Try multiple boom switches in case there is a faulty hardware switch connection.
5. With a small jumper wire (or paper clip), short between Ground and Signal with a “short-no short” motion. Each time a contact is made, the total volume should increase by increments of 1 or more.
 - If the total volume does not increase, remove the section of cable and repeat the test at the next connector toward the console. Replace defective cable as required and recheck.
 - If all cable tests pass then there is a problem with the flow meter / encoder. Replace the flow meter / encoder.

When finished, re-enter the correct Meter Cal or Density and Spreader Constant.

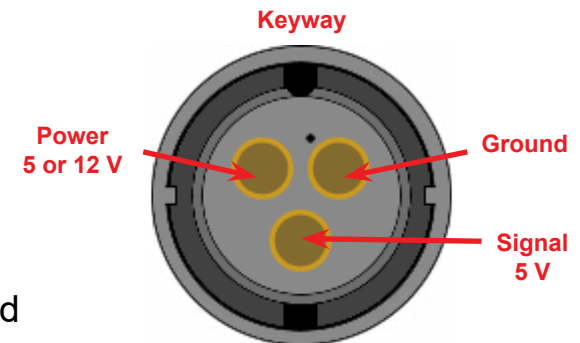

Erratic Rate

Cable Diagnostics

Check voltages to the valve, flow meter / encoder, and node (if applicable).

Inspect all cables for pinched or stripped wires, non-secure connections, rust / corrosion, damaged pins, etc.

Check the Pump / Hydraulics

If the machine's pump / hydraulics aren't functioning properly, our system will not be able to control the product.

Check all filters/strainers for any blockage.

Manual Product Control Test

Set a self test speed, then put the product in Manual.

If the rate settles, it is a **valve** issue.

- Is the rate within the valve's operating range?

If the rate is still erratic, it is a **flow meter / encoder** issue.

- For flow meters: Disassemble the flow meter and visually inspect the turbine blades and verify that it will spin freely when blowing through it.
- Is the rate within the flow meter / encoder's operating range?

If the rate is still erratic, it could possibly be a bad boom switch.

- Perform the Area/Hour test and do one boom switch at a time. Carefully watch the Area/Hour after turning each switch on. If the Area/Hour starts bouncing, that boom switch is bad.



SCS Spinner / Fan Speed Troubleshooting

Check Programming

The Fan Cal found in the Data Menu should be programmed as the number of bolt heads on the sensor.

Check Cabling

1. Check Voltage at the Fan RPM Sensor Connector

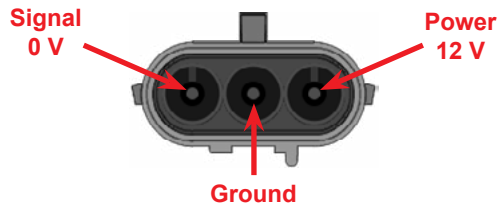

2. Check Voltage on the Product Cabling

Console Cable and Extension Cables		
Pin	Voltage	Description
1	-	Ground
5	0 V	Signal
14	12 V	Power

3. After Checking Voltages

If voltages are present on the console cable and any extension cables but not on the 3-pin connector then the product cable is bad and needs to be replaced.

If voltages are present on the console cable but not on any extension cables then the extension cable is bad and needs to be replaced.

If voltages are not present at the console cable connection then the console / console cable is bad and needs to be replaced.

Short / No Short Test

While monitoring the Fan RPM in the Data Menu, short with a small jumper wire between **Power** and **Signal** on the 3-pin Weatherpack connector. The Fan RPM should display a value other than zero when shorting.

Testing Sensor Connection	
Displays a Number (Other than Zero)	The RPM sensor is bad and must be replaced.
Displays Zero	Perform the test between Pins 5 and 14 on any extension cables on up to the console cable.
Testing Node Connection	
Displays a Number (Other than Zero)	The product cable and/or extension cable is bad and must be replaced.
Displays Zero	Either the console or the console cable is bad and must be replaced.

CAN/ISO Spinner/Fan Speed Troubleshooting

Check Programming

Spinner Control	Spinner Monitoring
Must have a product node/channel. Must have Application Type set to Spinner .	Does not use a product node/channel. Monitors spinner / fan speed only.*
Valve Type = Typically PWM Meter Cal = Number of Bolt Heads x 10 Rate Cal = Desired Spinner RPM	Fan Cal = Number of Bolt Heads on Sensor Used in the primary control product only.

* Fan speed can still be monitored when controlling the spinner. Put the Fan Cal in the primary product only, not the product controlling the valve which runs the spinner.

The PWM valve controlling the spinner will also require the Min PWM, Max PWM, Preset PWM, and PWM Frequency values to be calibrated. These values will depend on the specific machine/operation.

Make sure the Zero Speed Shutoff is not enabled for the spinner product so the spinner can maintain its speed even when the machine is not moving.

Check Cabling

1. Check Voltage at the Fan RPM Sensor Connector

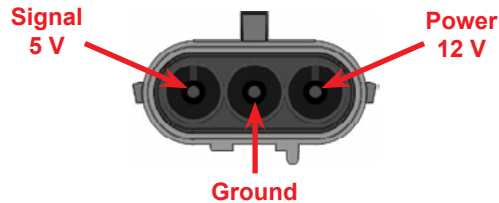

2. Check Voltage at the Node

Multi-Product / ISO Node 063-0173-236 / 063-0173-006			Single Product Node 063-0172-373 or 063-0173-304		
Pin	Voltage	Description	Pin	Voltage	Description
L3	12 V	S. Power (Orange Wire)	9	12 V	Power (Red Wire)
Frame Ground	-	-	7	-	Ground (White Wire)
X3	5 V	Signal (Violet Wire)	8	5 V	Signal (Violet Wire)

Dual Product Node 063-0172-315		
Pin	Voltage	Description
R1	12 V	Power (Red Wire)
T2	-	Ground (White Wire)
T3	5 V	Signal (Violet Wire)

Check Section Assignment

The above link goes over why sections are not painting, but it covers the screens necessary for going over section assignments.

3. After Checking Voltages

If voltages are present at the node but not on the 3-pin connector then the spinner control cable or product controller cable is bad and needs to be replaced.

If voltages are not present at either the 3-pin connector or the node connection then the node is bad (assuming the first product is functioning properly for a dual product node) and needs to be replaced.

If all voltages are correct, a “short / no-short” test should be performed between Ground and Signal on the 3-pin Weatherpack connector.

1. Enter a value of **1** into the Meter Cal / Density for the spinner product.
2. Place spinner product into **Manual**.
3. Turn section switch associated with product to the **ON** position.
4. While monitoring the Actual Rate, short with a small jumper wire between Ground and Signal on the 3-pin Weatherpack connector. The actual rate should display a value other than zero when shorting.

Testing Sensor Connection	
Displays a Number (Other than Zero)	The RPM sensor is bad and must be replaced.
Displays Zero	Perform the test between Ground and Signal pins on the node connection.
Testing Node Connection	
Displays a Number (Other than Zero)	The spinner control cable or product cable is bad and must be replaced.
Displays Zero	The node is bad and must be replaced.

Steering



Note: If auto-steering is not performing as desired (weaving, reacting slowly, etc.), it may not be an issue with the auto-steering system.

Always inspect and maintain the machine's mechanical components as well as the hydraulic system.

Auto-steering will not work properly if there are any issues with the machine.

Not Engaging

Connections

External GPS

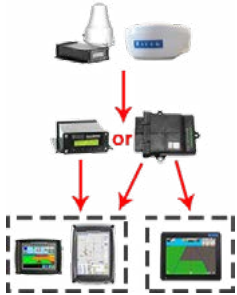

GPS will go from the output on the receiver and connect to the input (DGPS) on the SmarTrax node or control box.

GPS will then go from the output on the node cabling, or the Lightbar port on the control box, and connect to the input (DGPS) on the field computer cabling.

Internal GPS

GPS will go from the output on the field computer cabling and connect to the input (DGPS) on the SmarTrax node or control box.

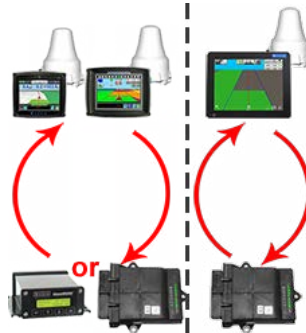

GPS will then go from the output on the node cabling, or the Lightbar port on the control box, and connect to the input (DGPS) on the field computer cabling.

Note: The Viper 4 **is not** supported for use with SmarTrax serial controllers (short and long box).

Helpful Info

[Knowledge Article on Connecting and Configuring GPS with SmarTrax](#)

Settings

GPS Source

Viper Pro	Generic GPS
Envizio Pro	Internal via Tilt or SmarTrax
Viper 4	SmarTrax GPS on DGPS

NMEA Messages

GGA	10 Hz (0.1 Seconds)
VTG	10 Hz (0.1 Seconds)
ZDA	0.2 Hz (5 Seconds)

Baud Rates

GPS Receiver Output to SmarTrax	19200
GPS Baud in SmarTrax Settings	19200
SmarTrax Output to Field Computer	115200

Must Match!

Steering and Foot Switch Status Changes

Manual Steering

SmarTrax Controller
Upper vs. Lower Case



Envizio Pro
Green vs. Red

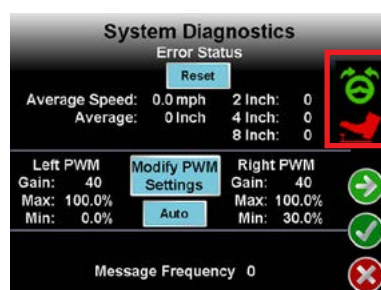

Viper 4 (ROS)
Green vs. Red



Viper Pro
Upper vs. Lower Case

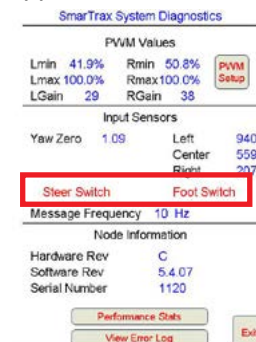

[Knowledge Article on How to Steer in Manual](#)

Weaving and Line Acquire

Slow / Gradual Weaving

What To Try

Verify the antenna Fore/Aft measurements.

Increase the PWM values gradually by 1-2% at a time.

Increase the sensitivity (OL) by 1-2 at a time, allowing 30-40 seconds between adjustments.

Inspect the steering sensor.

Inspect the mechanical components of the machine's steering. If there is a lot of play in the steering, auto-steering will not work properly.

Erratic / Jerky Weaving

The sensitivity and/or PWM Min settings are too high.

What To Try

Look to see where the PWM Min values are set (they will vary by each machine from when it was last calibrated). Usually, they range between 20-40%. If it is higher than 40%, it may be too high. Lower it gradually by 1-2% at a time.

Decrease the sensitivity (OL) by 1-2 at a time, allowing 30-40 seconds between adjustments.

Not Acquiring the Line Fast Enough

What To Try

Verify the antenna Fore/Aft measurements.

Line Acquire (LA) setting is too low. Increase by 1-2 at a time, allowing 30-40 seconds between adjustments.

Try directing the machine's heading to look as straight down the line as possible before engaging SmarTrax.

Over-Steers when Acquiring the Line

What To Try

Verify the antenna Fore/Aft measurements.

Line Acquire (LA) setting is too high. Decrease by 1-2 at a time, allowing 30-40 seconds between adjustments.

Try directing the machine's heading to look as straight down the line as possible before engaging SmarTrax.

SmarTrax MD Error Messages

Message	Possible Cause	Corrective Action
HC Volt H	SmarTrax MD has detected a supply voltage greater than 16 volts.	Check the battery voltage and connections.
HC Volt L	SmarTrax MD has detected a supply voltage less than 10.6 volts.	Check the battery voltage and connections.
HS Fail	The hardware inside the mechanical drive is damaged.	<ol style="list-style-type: none"> 1. Navigate to the SmarTrax Manual Steering screen. 2. Toggle the master switch on and off verifying that the Raven LED logo changes from white steady to blue steady. 3. Drive the motor at various settings while monitoring the Actual Current value. If no current is drawn and the problem persists, replace the mechanical drive.
HW Wrong	The Device does not support the installed software.	<ol style="list-style-type: none"> 1. Verify the software version. 2. Reprogram the device with the correct software version.
MsSw Fail	The hardware inside the mechanical drive is damaged.	Manually toggle the master switch between “ON” and “OFF”.
		Replace the SmarTrax mechanical drive.
MsSw Off	The master switch is in the “OFF” position.	Manually toggle the master switch to the “ON” position. It is located underneath the MDU.
No HC Sync	The hardware inside the mechanical drive is damaged.	<ol style="list-style-type: none"> 1. Navigate to the SmarTrax Manual Steering screen. 2. Toggle the master switch on and off, verifying that the Raven LED logo changes from white steady to blue steady. 3. Drive the motor at various settings while monitoring the Actual Current value. If no current is drawn and the problem persists, replace the mechanical drive.
Oper Error	The operator presence switch has been disconnected for more than seven seconds.	Check the operator presence switch connection.
OpSW Fail	The operator has been out of the seat for more than two seconds.	Return to the operator’s seat.
		Check the operator presence switch connections.
Torque H	SmarTrax MD has detected a current draw greater than 8 amps.	Check the mechanical drive system for binding conditions.
		<ol style="list-style-type: none"> 1. Navigate to the SmarTrax Manual Steering screen. 2. Toggle the master switch on and off, verifying that the Raven LED logo changes from white steady to blue steady. 3. Drive the motor at various settings while monitoring the Actual Current value. If no current is drawn and the problem persists, replace the mechanical drive.

GPS



GPS Mode / GGA Quality Numbers

Number	Status
0	No Satellites Found
1	Satellites Found but no Differential Lock
2	SBAS / WAAS Differential Lock; GS Converging
4	RTK Fixed Mode
5	RTK Float Mode; Converged for OmniSTAR HP/XP and GS

Line Jumps / Shifts

Line Jumps During the Same Job

Using SmarTrax?

To determine if SmarTrax is the cause of the line jump, try bypassing 3D. If the issue goes away after bypassing 3D, then the issue may be with the SmarTrax node. If the SmarTrax node is causing the issue, it will need to be sent in for repair.

PRN Satellite

Most GPS receivers have the PRN satellite set to Auto by default. In some cases, this may not be desired as it can cause sudden shifts in guidance (usually 3-6 feet). Locking onto a specific PRN satellite will usually resolve this issue. Choose the satellite with the highest Signal to Noise Ratio (SNR) for best performance.

When the PRN setting is set to Auto, the time of day may be a contributing factor.

Note: With newer GPS firmware versions, it is recommended to leave the PRN setting at Auto for best performance. Only change to a specific PRN if there is a swath jump issue.

Line Has Shifted (Same Line, New Job)

Drift

Depending on the accuracy of GPS corrections when the line was made (e.g. WAAS/SBAS vs. RTK), all created features such as AB lines and field boundaries may shift due to the movement of satellites over time. To compensate for this, use the Nudge feature during a job on the field computer.

Nudge Buttons



Envizio Pro Series



Viper 4 (ROS)



Viper Pro

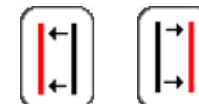

No GPS / Differential Lock

No GPS Whatsoever

Carefully inspect the GPS antenna and the cabling connecting it and the field computer / display. Make sure that there are no extreme bends in the cabling as they may cause the wires to pinch or even break.

If using SmarTrax, make sure all settings are correct.

Make sure there is nothing in the way that will block the antenna's view of the sky.

Check for 12 volts for power going to the receiver when the machine is off. If there are 10 or less volts, it could possibly be a bad battery. There should also be 5 or 8 volts going to the antenna (see voltage table).

Try to make sure there is no excessive length to the antenna cable. Also, do not coil up any excess length. This could cause an inductance issue.

Differential Drops Out

Ensure nothing has changed as far as the antenna having a clear view of the sky.

Test for voltages, trying to test as the problem occurs. A bad power and ground can cause differential to drop out.

~12 volts to the receiver (10 volts or less when the machine is off could mean a bad battery.)

- 12 Volts for Cruizer, Envizio Pro II, and Viper 4

5 or 8 volts to the antenna (see voltage table).

Have a GPS Signal, but No Differential Lock

First try changing the PRN satellite. If that does not help:

1. Verify there is adequate voltage to the receiver. Some receivers have a voltage monitor option.
2. Check voltage to the antenna (see voltage table).
3. Cycle power and wait up to 5 minutes.
4. Make sure the machine is out in the open with a clear view of the sky.
5. Note current settings then re-initialize the receiver. Wait at least 5 minutes for new satellite information to load.
6. If re-initializing does not work, check the Signal to Noise ratio for the given PRN satellite (>50 minimum for RTK).
 - 20+ for RPR 210 and 310
 - 40+ for Phoenix 200, 300, and internal GPS.

If this process fails, the issue may be with the receiver, the antenna, or the cable.

Specific Receiver Voltages

Receiver	To Receiver	To Antenna
RPR 210/310	12 V between pins 1 and 3 on the PWR cable	8 V
Phoenix 200	12 V between pins 6 and 7	-
Phoenix 300	12 V between pins 1 and 3 on PWR cable	5 V
Cruizer (II)	12 V between inside and outside of plug	5 V
Envizio Pro	12 V between pins 1 and 16 on console cable	5 V
Viper 4	12 V between pins 1 and 4 on 4-pin connector	5 V

Field Computers



**Cruizer
Series**



**Envizio Pro
Series**



**Viper 4
(ROS)**



Viper Pro

Touch Screen Issues

Cursor Moves to Specific Location

If the cursor consistently moves to a specific location on the screen, it is a good sign of a pressure point between the layers of the touch screen in that location. This will usually need to be repaired.

Important: For cursors that move to the edge of the screen, do not use anything (credit cards, business cards, tools, etc.) to try to remove any debris that may or may not be present.

Attempting this can potentially result in disconnecting or even breaking the touch screen's wiring connections.

Cursor Moves Erratically (“Bounces Around”)

Typically software related. Something is interfering in the background of the software program. This is usually resolved by re-installing software. In this case, a Clean/Silent Install is recommended.

Cursor Does Not Move

Can either point to an issue within the software or the screen itself.

First try re-installing software using a Silent/Clean Install. If that does not work, it is likely an issue with the touch screen and it will need to be repaired.

A wired USB computer mouse can be used to run the field computer until it can be sent in for repair. A wireless USB mouse will not work for the Viper Pro or Envizio Pro. The Viper 4 supports using a wireless mouse and keyboard.

Display Issues

Display Does Not Turn On

Commonly a hardware issue with the screen. However, when this happens with a Cruizer II, it could be a software/memory issue.

If the screen is not turning on, check the following to verify that it is only a screen issue and not an issue with the entire field computer.

- Listen for the fan inside the field computer to see if it is working. It may be necessary to have the machine off in order to hear the fan. If the fan is running, it is likely only an issue with the screen.
- For Envizio Pro and Viper Pro, look at the blue power button. If you look closely, there should be a light behind the button. If you can see the light behind the button, it is likely only an issue with the screen.
- On the Cruizer II, the lightbar lights often light up as they would during a standard startup. Perform a silent boot / silent install. If that does not work, it is likely an issue with the screen.
- Look very closely at the screen itself (while the unit is on). There may be information visible on the screen. If this is the case, the issue is with the backlight for the screen.

Display Shows a White Screen or Strips of Color

Commonly caused by voltage issues.

For the Envizio Pro and Viper Pro, check voltage between pins 1 and 16 on the console cable (it will be the connector with female pins). If it registers 12 volts, plug the cable back into the field computer and make sure it is securely fastened. If the screen is still white or has strips of color, it is a hardware issue.

For the Cruizer (II) series, check voltage on the power plug. The inside of the plug is Power and the outside is Ground. If it registers 12 volts, plug the cable back into the field computer and make sure it is securely fastened. If the screen is still white or has strips of color, it is a hardware issue.

Software Errors

Viper Pro “Zulu” Errors

The best solution is to perform a Clean Install with the latest version of software.

When zulu errors occur, it is not recommended to clone a profile and reload it after a Clean Install. This has a risk of cloning the corrupt file.

[Viper Pro Clean Install Knowledge Article](#)

Cruizer “MiniZ.exe” Errors

The error may also appear as “czmini.”

The best solution is to perform a Silent Install with the latest version of software compatible with either the Cruizer or Cruizer II.

[Cruizer \(II\) Silent Install Knowledge Article](#)

Envizio Pro “Missing Skins” and “.XML” File Errors

The best solution is to attempt reloading software. If that does not take care of the error, performing an Envizio Pro Recovery (Silent Install) will be necessary.

[Envizio Pro Recovery Knowledge Article](#)

Software Fixes Not Working?

If none of the above software fixes resolve the issue, it is possibly a hardware issue. If this is the case, the unit will need to be sent in for repair.

Potential Causes

If it happens after a software update...

One or more files have not copied properly with the new update. Something could have either gone wrong when downloading the update online, or the USB flash drive is not functioning properly.

If the field computer has been running normally, and there has not recently been a software update...

It is usually the result of improper shutdown, causing one or more files to become corrupt. Often happens when the field computer is shut down while a job is open.

Key Terms Explained

Clean Install

Erases and overwrites all files when updating software.

Silent Install

Automatically installs software in the background upon startup. Does not require any user input other than inserting the USB drive and powering the unit on.

Activation Keys

Activation Keys vs. Registration Codes

Registration Code

Code generated by Raven to unlock a particular feature on any field computer. Codes are series specific (i.e. - An Envizio Pro Registration Code will work with any Envizio Pro field computer, but not for any Viper Pro.). Used to create an Activation Key on the Raven Customer Portal.

Activation Key

Similar to a Registration Code, but for a specific field computer. Key is generated by combining a Registration Code, Machine ID, and Validation Code (or just the Bar Code ID for Viper 4). Used to unlock a feature on the field computer.

Entering Activation Keys into an Envizio Pro



1. At the bottom the of the screen, select Special Features Registration.
2. Note the Machine ID and Validation Code.
3. Fill out the Activation Key Request with the proper information on the Raven Customer Portal.
4. On the Special Features Registration Page, select **Enter Activation Key**.
5. Using the keypad, enter the Activation Key (case sensitive).
6. When finished, do the following:



Accept



Do not select the check mark icon!

Entering Activation Keys into a Viper Pro

1. From the Main Viper Pro screen select **Menu, Setup**, then **Reg Keys**.
2. From the Validation Data screen, note the Machine ID and Validation Code.
3. Use this information along with the Registration Code to create the Activation Key.
4. Fill out the Activation Key Request with the proper information on the Raven Customer Portal.
5. On the Validation Data screen, select **Next** to navigate to Key 1. If there is already a key entered, continue to select **Next** until you find a key slot that is empty.
6. Using the keypad, enter the Activation Key (case sensitive).
7. Select **OK**. This will take you back to the Main screen and there will be an “Activation Keys Validated” pop up showing that the Activation Key was accepted and what was unlocked. Select **OK**.

Entering Activation Keys into a Viper 4

1. Fill out the Activation Key Request on the Raven Customer Portal using the Registration Code and Bar Code ID from the Viper 4.
2. Once complete, the Activation Key must be downloaded. This downloaded .zip file should be saved to the “FeatureUnlocks” folder on the USB flash drive used with the Viper 4.
 - Removable Disk
 - Raven
 - FeatureUnlocks
 - 3700362.zip
3. To apply the software unlock, insert the flash drive into the Viper 4. After a short time, a message will be displayed prompting the operator to restart the field computer. Remove the USB flash drive before restarting the Viper 4.

Sections Not Painting

Envizio Pro Series

Viper Pro

Viper 4 (ROS)

Section Mapping May Be Incorrect

Tools → **Product Control** → **Section Assignments**

Make sure all booms are checked for the product.

Product Control → **Select within the Boom Cals Section.**

Make sure all booms are checked for the product.

Also, make sure all booms are associated with the product when starting the job.

Product Control → **Section Settings**

Make sure all booms are checked for the product.

If Using AccuBoom Control, Settings May Be Incorrect

Tools → **Product Control** → **AccuBoom**

Make sure AccuBoom is applied to the product(s).

Make sure AccuBoom Control is enabled for the job.

Select within the booms section of the Home Screen, then select **Next**.

Make sure there is a check next to the product(s) being controlled by AccuBoom.

Make sure AccuBoom is enabled.

Make sure AccuBoom Control is enabled for the job.

AccuBoom

Make sure AccuBoom is enabled.

Make sure AccuBoom is applied to the product(s).



If all of the section and AccuBoom (if installed) settings are correct, it may be necessary to check the boom sense from the machine's switches. The boom speed node needs to see 12 volts from each switch. Also, make sure that the section(s) have accurate section widths entered.

[How to Test for Boom Sense](#)

AccuBoom

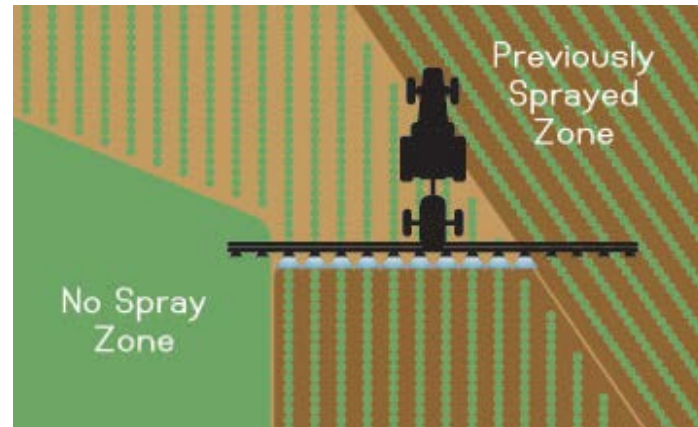

Sections do not turn on at all.

Sections stay on and do not turn off.

**Occurs when entering or leaving
previously applied areas.**

Sections Not Turning On/Off

Verify Field Computer Settings

Envizio Pro, Viper Pro, and Viper 4 (ROS)

Verify that the sections are assigned to a product, and that AccuBoom is enabled for that product. Checking these settings can often resolve issues with the sections not physically turning on as well as not painting.

Make sure that AccuBoom Combo Node is checked if using a combo node, or that it is not checked when not using a combo node.

Verify Switch Statuses

Serial Product Control

If using serial product control, the boom switches must be in the **OFF** position when using AccuBoom.



CAN Product Control

If using CAN product control, the boom switches must be in the **ON** or **ACCU** position when using AccuBoom.



Verify Vehicle Ground Speed

AccuBoom will not turn sections on without physical ground speed (wheel magnet, radar, or GPS).

Sections will not turn on when using a self test speed with AccuBoom control enabled.

Also, after stopping the machine it may be necessary to cycle the master switch.

Check the Node Lights (If Applicable)

Verify that Logic and HC Power are on solid and that Micro 1Hz and CAN Rx/TX are all flashing. This will help to diagnose any CAN or power/ground issues.

More importantly, check the Diag 1 light. This will be illuminated when the node senses the master sense. Without the master sense, AccuBoom will not control the sections.

Turning On/Off Too Early/Late

Machine Measurements

Antenna offsets and machine measurements are extremely important, especially when using AccuBoom. If sections are either turning off too early or too late, any one of the measurements can be off depending on how exactly the machine is entering the previously applied area (straight on versus at an angle).

Each field computer will have images which show how the measurements / offsets need to be entered regarding the antenna location.

GPS Antenna Reference Locations

Fore	Ahead of the reference point
Aft	Behind the reference point

For Envizio Pro and Viper Pro:

The fore/aft offset is based on the antenna location in reference to the **boom**.

For Viper 4 (ROS):

The fore/aft offset is based on the antenna location in reference to the machine's **rear axle**. There is a separate fore/aft offset for the boom compared to the rear axle.

The fore/aft offset can often get entered incorrectly when users work with between different field computers on a regular basis.

On / Off Look-Ahead

Turn-On Look Ahead

Will normally start at 1.5 to 2 seconds. Increase this number if sections are not turning on soon enough or if the system is not building enough pressure in time.

Turn-Off Look Ahead

Will normally start at 0 to 0.5 seconds. Increase this number if sections are turning off too late.

Note: Always have the turn-on look ahead higher than the turn-off look ahead to avoid potential issues.

AccuBoom Aggressiveness Setting for Outer Sections on Larger Booms

Off	Low	Medium	High	Very High
0%	15%	35%	60%	100%

Recommended Setting	
Envizio Pro	Off
Viper Pro	Very High (Max)

Use this setting when skipping occurs on the outer sections when they sweep across point rows.

AutoBoom



Booms Drop when Engaging

Center Rack Goes Up but Does Not Come Back Down

Opposite Boom Is Reacting

Common Issues

Booms Drop when Engaging

Can be due to any number of causes. Use the troubleshooting work-flow below.

Center Rack Goes Up but Does Not Come Back Down

In many machines, it is necessary to enable a boom valve and/or master apply switch in order for the Center Rack Control to bring the center rack back down.

AutoBoom Speed Ranges

The Speed value will vary largely on the machine's boom weight. The setting lets AutoBoom know that it either needs to apply more pressure to raise the booms faster or less pressure so the booms can lower faster.

Range	Used For	Static Pressure Needed
0 to 99	Most Machines	900 to 1800 PSI
100 to 199	Heavy Booms	1800 PSI or Greater
200 to 255	Light Booms	900 PSI or Lower

Opposite Boom Is Reacting

The Stability setting may be off.

- Opposite boom raises - Stability may be too low.
- Opposite boom is drops - Stability may be too high.

The ultrasonic sensor connections may be reversed.

Troubleshoot the hydraulics. The proportional valve could be the cause.

Troubleshooting Work-flow



Base values may creep for many reasons, so checking settings or recalibrating is often recommended first. If that does not resolve the issue, it is best to test the electrical connections before testing the hydraulics. Using this general work-flow should help reduce any unnecessary work when troubleshooting AutoBoom.

Electrical Troubleshooting

Old Hydraulic Block

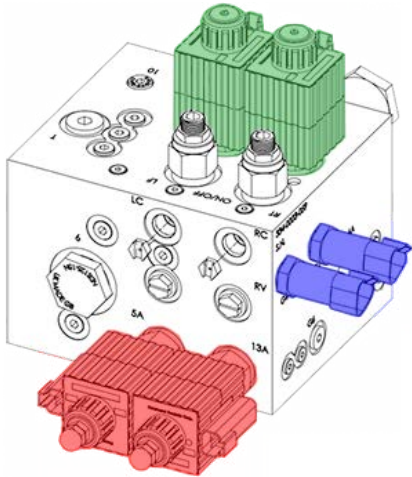

Proportional Valves

Pressure Transducers

Blockers

New Hydraulic Block

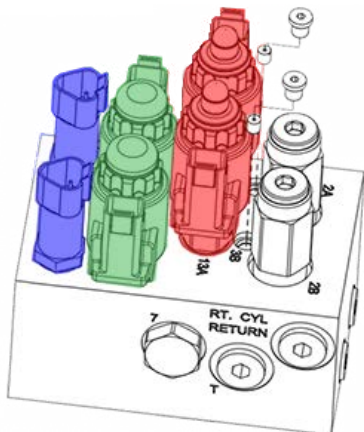

Verify that the electrical connections are connected correctly. The 2-pin Deutsch connectors labeled “Solenoid” connect to the blockers. The “Prop” connectors connect to the proportional valves.

You may also want to verify the wire colors are correct in case the cables were not tagged correctly.

Raven Prop and Solenoid Wires

Connector	Wire Colors
Left Solenoid	White and Blue
Left Prop	Red and White
Right Solenoid	Violet and White
Right Prop	Orange and White

The last thing to check is voltages at the valve when commanding an up or down function from the Diagnostic screen.

- Blocker connections should be outputting 12 volts on an up or down command.
- Proportional connections will have variable voltage on a up or down function.

If one side is working, swap left and right connections and use the up and down functions again to determine if the issue is actually electrical or if it is hydraulic.

If unable to control AutoBoom from the Diagnostic screen:

- Node/cabling issue if voltage is not present.
- Hydraulic/valve issue if voltage is present.

Proportional Valve Voltages

Scenario	Control Node
AutoBoom Manual Raise	~ 8
AutoBoom Manual Lower	~ 4
AutoBoom Normal Operation	4 - 8

Blocker Voltage

Scenario	Voltage (VDC)
AutoBoom Disengaged	0
AutoBoom Engaged	12
AutoBoom Trying To Raise	12
AutoBoom Trying To Lower	12

Different PSI Voltages

Pressure Reading (PSI)	Signal Voltage (VDC)
100	12.65
500	12.12
1000	11.45
1500	10.78
2000	10.11
2500	9.39
3000	8.74

Hydraulic Troubleshooting

Old Hydraulic Block

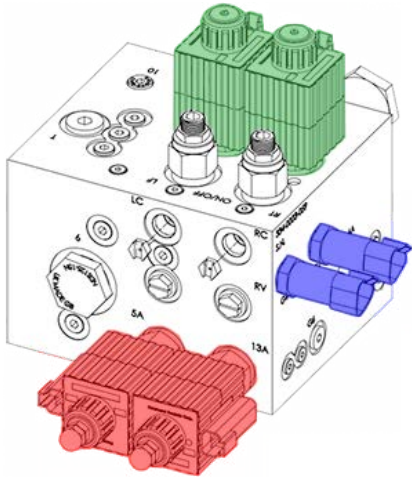

Proportional Valves

Pressure Transducers

Blockers

New Hydraulic Block

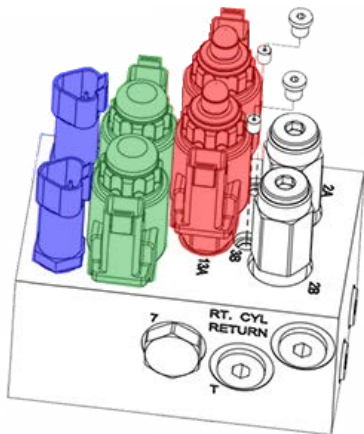

Verify that the hydraulics are connected and working correctly. This can be done directly from the AutoBoom hydraulic valve block.

With the machine running and the booms folded out:

1. Press on the top of the blocker cartridge. The booms should lower.
 - For the older hydraulic block, it may be necessary to use a hammer and punch to activate the blockers.
2. Remove the cap from the top of the proportional valve. With an allen (hex) wrench, screw in the adjustments all the way.
3. Press (or hammer the punch) on the blocker valve again. The booms should raise.
4. Once this has been verified, back out the adjustments all the way on the proportional valves and re-install the caps.

If you suspect a faulty proportional or blocker valve, first troubleshoot the electrical connections. If the fault is not found, swap the left and right valves (do not swap a proportional valve with a blocker valve).

- If the problem follows the valve, the valve is faulty.
- If the problem stays with the boom, the problem is either with the AutoBoom valve block or the machine's hydraulic system.

Be sure to inspect and clean any hydraulic fluid filters to verify the condition of the hydraulic fluid. Contaminated fluid can cause several issues.

Also, any debris within the hydraulic fluid can get caught in the proportional valves, which may cause them to stick and cause issues.

Slingshot



ROS Only

3G Field Hub Lights



Green Lights Only



Link

Illuminated when a link is established with an Ethernet device (i.e. Raven field computer)

Activity (Act)

Flashes when data is being transmitted/received by the Ethernet device.

Power

The Power light represents whether the unit is powered on or powered off.

Signal

The Signal light represents connectivity and communication with a cellular network only. It does not mean that the user has a data plan; only that the Field Hub can communicate with a cellular network. The faster the light blinks, the better the signal strength.

WAN

The WAN light represents the status of wireless communications. A flashing light indicates data is being transmitted/received over the wireless network. This light will be on (solid) when a link is established but there is no current data activity. A solid light usually means that there is not a current data plan.

232

The 232 light is lit when the Field Hub is receiving a correction signal from the Slingshot servers. If the 232 light is not on, there could be an issue with the correction profile settings, the base station, or the CORS network (if applicable).

GPS

The GPS light on the Slingshot Field Hub is lit when the hub is receiving GPS signal from the patch antenna that comes with the hub. This GPS references the Field Hub's location so that it can be tracked from the website. It is completely separate from the GPS receiver that provides corrections to the field computer or used for RTK. If the GPS light is not lit, the Field Hub can still function normally, but its position cannot be viewed from the Slingshot website. If there is no GPS light, the "ignition dot" on the Slingshot website will be in a yellow, or caution, state.

Field Hub 2.0 Lights



Multi-Colored Lights

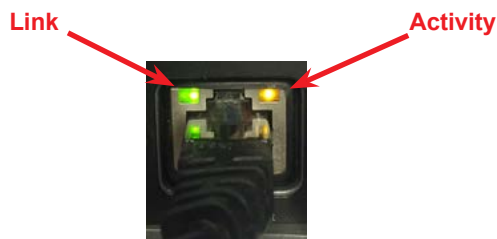
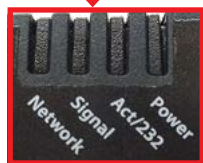

Link

Illuminated when a link is established with an Ethernet device (i.e. Raven field computer)

Activity

Flashes when data is being transmitted/received by the Ethernet device.

Status Indicator	Light Color	Status Description
Power	Solid Green	The Field Hub is powered on. <i>Note: The Field Hub goes through a power down sequence when the ignition is switched off. It is normal for the Power LED to remain on for approximately 60 seconds after the ignition switch is turned off.</i>
	Solid Green with Yellow Flashing Every 4 Seconds	The Field Hub has a fixed GPS signal.
	Solid Yellow	The Field Hub ignition power is off and the Field Hub will shut down soon.
	Solid Red	The Field Hub is not operational.
ACT/232 Displays the activity over the WAN connection and serial port.	Flashing Yellow	Data is being transmitted or received over the serial port and WAN interface at the same time.
	Flashing Red	Data is being transmitted or received over the serial port.
	Flashing Green	Data is being transmitted or received over the WAN interface.
	Flashing Yellow or Red/Green	Data is being transmitted or received over the serial port and the WAN interface simultaneously.
Signal Displays the current cellular signal strength.	Solid Green	The cellular signal is strong. RSSI > -85dBm
	Solid Yellow	The cellular signal is marginal. (-100 dBm < RSSI < -85 dBm)
	Solid Red	The cellular signal is poor. (-110 dBm < RSSI < -100 dBm)
	Flashing Red	No cellular signal is available. (RSSI < -110 dBm)
Network Displays the status of the cellular network.	Solid Green	The network is ready and LTE service is available.
	Flashing Green	The network is ready and LTE service is roaming.
	Flashing Yellow/Green	The network is ready, 2G or 3G service is available.
	Flashing Yellow/Green/Off	The network is ready, LTE service is not on, and roaming 2G or 3G.
	Solid Yellow	Connecting to the network.
	Flashing Yellow	No service is available.
	Solid Red	The link to the network is down, no cellular network is present.
	Flashing Red	Authentication/negotiation has failed. (EV-DO only)

Connection Issues

Check the Lights

Start with looking at the Signal light. If there is no Signal light, there will never be a WAN light.

Even though the Signal light refers to signal strength, not having this light usually points to antenna issues.

Could be bad antenna, bad cable, or possibly an issue in the Field Hub itself.

No WAN Light

Is the Signal light on? No Signal = No WAN.

Have there been any changes to the data plan? Is the plan still current?

Has the Field Hub been provisioned? If so, was the provisioning successful?

- If not, there could be an issue with the Field Hub, the SIM card, or the data plan.

No 232 Light

Is the WAN light on? No WAN = No 232.

Are there any issues with the cabling?

Is the Field Hub assigned to Base Station or CORS network?

CORS Network Users

- Are the credentials correct?
- Is the GPS light on?
No GPS = No CORS Corrections.
- No GPS light could mean the Field Hub needs to be re-flashed, a bad GPS antenna, or the GPS module inside the Field Hub has gone bad.

Remote Support Issues

Right Field Computer Software?



	Envizio Pro	Viper 4	Viper Pro
Java 7	All Versions	2.0.10	3.9.0.17 and Older
Multi-Client Remote Support	3.7.0.56 and Newer	2.0.10 and Newer	3.10.1.13 and Newer

Browser Limitations

Google Chrome

Java 7 is no longer compatible with Chrome. Field computers will need to be updated to the software versions compatible with multi-client remote support.

[Slingshot Remote Support Compatibility with Java](#)

Make sure your internet browser is up to date to ensure compatibility with multi-client remote support.

Open Network Ports

Port	Reason for Use
17701 / TCP	Used when the request comes from the field computer (through the Field Hub).
17702 / TCP	Used with an old browser and field computer software capable of doing remote support only through Java.
17712 / TCP	Used with a new browser and field computer software capable of doing remote support using modern technologies.
18058 and 18059 / TCP	Used for field computers with old software versions.

Problems with Corrections

Inspect the Field Hub

Verify that the antenna cables and all other cable connections are fully connected. Several communication issues may be traced back to loose or disconnected cables.

Verify that the indicator LEDs on the Slingshot Field Hub are on or flashing as described:

Power (on solid) - the Field Hub is powered.

Signal (blinking or solid) - the main and diversity antennas are connected and the Field Hub is receiving a signal.

WAN (blinking or solid) - connected and communicating with the cellular network as well as connecting to the Slingshot server.

GPS (on solid) - needed for corrections when on a CORS network.

232 (blinking) - the Field Hub is receiving RTK corrections from the server, via either a CORS network or a Slingshot Base Station.

Check the network credentials for the correction profile for the Field Hub on the Slingshot website. This would especially be necessary if the 232 light is not blinking.

Inspect the DGPS Receiver

Check the following items on the DGPS receiver:

- Check the RTK format setting on the receiver. Verify that the setting matches the correction format displayed on the Slingshot account via the Slingshot website.
- Verify that the baud rate is set to 115200 on the DGPS receiver to match the Slingshot Field Hub.
- If possible, verify that RTK correction signals are being received by the DGPS receiver.
- Inspect the cabling between the receiver and the Field Hub. Verify that it is the correct cable and that there are no loose connections.

CANBUS and ISOBUS



Node Lights

Logic Power: Lights up solid when 12V are seen for Logic Power

HC Power: Lights up solid when 12V are seen for high current power.

Micro1Hz: Flashes once per second if processor is working correctly in node.*

CAN Rx: Flashes intermittently when CAN communication is present going to the node.

CAN Tx: Flashes intermittently when CAN communication is present going away from the node.



Diagnostic 1

Control Node	Light Definition
AccuBoom	Lit when the master switch or any boom section switch is in the on position. Indicator should not be illuminated if the master and all boom section switches are toggled to the off position.
AutoBoom	Lit if a second Ultrasonic sensor is detected on one of the booms.
SmarTrax and SmartSteer	Lit when the node is receiving GPS messages from a DGPS receiver.
Product Controller, Air Cart, and Planter/Seeder Aux. Nodes	<ul style="list-style-type: none"> • Solid - Calibration is not complete for at least one of the active products (e.g. missing rate cal, meter cal, valve cal, etc.). • Flashing - Node is receiving meter or encoder transitions from one of the active products; or • Flashes for one second when the remote section controller is used for every received key press.
Planter Control Node	<ul style="list-style-type: none"> • Solid - Calibration is not complete for at least one of the active products (e.g. missing target population, meter cal, valve cal, speed cal or section setup). • Flashing with meter cal set at 1 - Node is receiving encoder transitions from one of the odd-numbered active controls. • Flashing with meter cal set at value other than 1 - Indicates that the node is receiving seed singulation transitions from one of the odd-numbered rows. • Flashes for one second when the remote section controller is used for every received key press.

Diagnostic 2

Control Node	Light Definition
AccuBoom	Lit if the wireless remote section controller is being used.
AutoBoom	Lit if a second Ultrasonic sensor is detected on one of the booms.
SmarTrax and SmartSteer	Lit if the 3D unlock code has been entered and accepted.
Product Controller, Air Cart, and Planter/Seeder Aux. Nodes	<ul style="list-style-type: none"> • Flashes to indicate that the node is receiving encoder transitions for the right side (Gran 3 systems only) or fan, spinner, or pump RPM transitions; or • Flashes once for every key press when the remote section controller is used.
Planter Control Node	<ul style="list-style-type: none"> • Flashing with meter cal set at 1 - Node is receiving encoder transitions from one of the even-numbered active controls. • Flashing with meter cal set at value other than 1 - Indicates that the node is receiving seed singulation transitions from one of the even-numbered rows. • Flashes once for every key press when the remote section controller is used.

*AccuBoom systems using the AccuBoom master sense wire to activate the system require a CAN signal from the console each time at start up to set it up that way. If CAN communication is not received from the console to tell it this, the 1Hz light will go from flashing once a second to flashing very quickly if the master switch is turned on since the console was not expecting the master signal.

CAN Cable Testing

Generation I

Pin	Description	Gen I Connector	Pins	Multimeter Test
1	CAN Power		1 to 3	+12 VDC
2	CAN High Signal		2 to 3	2.5 VDC (± 1 VDC)
3	CAN Ground		3 to 4	2.5 VDC (± 1 VDC)
4	CAN Low Signal		2 to 4 Resistance	75 Ohms (2 Terminators) 150 Ohms (1 Terminator)

063-0172-369 Terminator

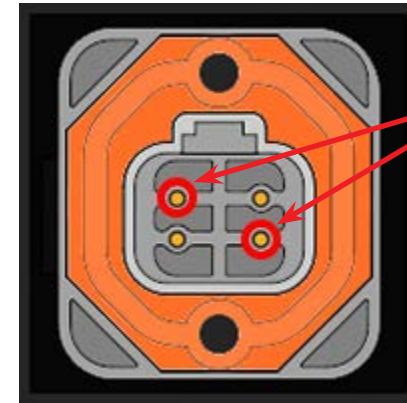

Generation II

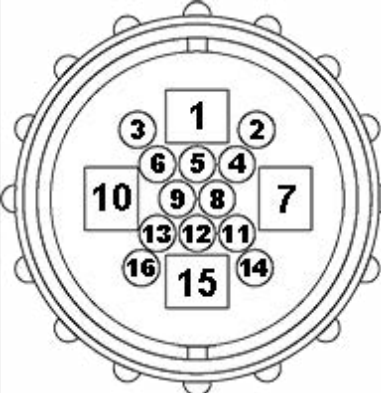
Pin	Description	Pin	Description	Gen II Connector	Pins	Multimeter Test
1	High Current Ground 1	9	CAN Low Signal		1 to 10	+12 VDC
2	(Not Populated)	10	High Current Power 1		7 to 15	+12 VDC
3	Switched Logic Power	11	(Not Populated)		3 to 4	+12 VDC
4	Logic Ground	12	(Not Populated)		5 to 8	+12 VDC
5	CAN Power	13	(Not Populated)		6 to 8	2.5 VDC (± 1 VDC)
6	CAN High Signal	14	Remote Master Signal		8 to 9	2.5 VDC (± 1 VDC)
7	High Current Ground 2	15	High Current Power 2		6 to 9 Resistance	75 Ohms (2 Terminators) 150 Ohms (1 Terminator)
8	CAN Ground	16	(Not Populated)			

150 Ohms

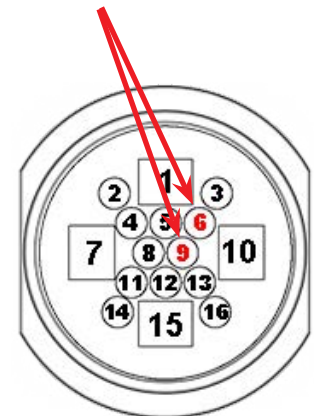

063-0173-224 Terminator

ISO Cable Testing

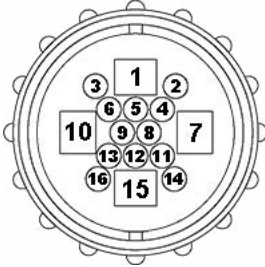
Pin	Description	Pin	Description	ISO Connector	Pins	Multimeter Test
1	High Current Ground 1	7-8	(Not Populated)		1 to 10	+12 VDC
2	(Not Populated)	9	CAN Low Signal		3 to 4	+12 VDC
3	Switched Logic Power	10	High Current Power 1		1 to 6	2.5 VDC (±1 VDC)
4	Logic Ground	11-13	(Not Populated)		1 to 9	2.5 VDC (±1 VDC)
5	(Not Populated)	14	Remote Master Signal		1 to 14	+12 VDC when switch is active.
6	CAN High Signal	15-16	(Not Populated)			

Pin	Description	Pin	Description	To Terminator Adapter Cable	Pins	Multimeter Test
1	High Current Ground 1	8	CAN Ground		22 to 1	+12 VDC
2	(Not Populated)	9	CAN Low Signal		3 to 4	+12 VDC
3	Switched Logic Power	10-13	(Not Populated)		5 to 8	+12 VDC
4	Logic Ground	14	Remote Master Signal		9 to 6	+12 VDC
5	CAN Power	15-21	(Not Populated)		6 to 8	2.5 VDC (±1 VDC)
6	CAN High Signal	22	High Current Power 1		8 to 9	2.5 VDC (±1 VDC)
7	(Not Populated)				14 to 1	+12 VDC when switch is active.

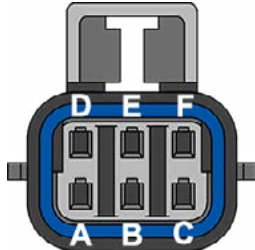
Pin	Description	Terminator Adapter Cable	Pins	Multimeter Test
A	(Not Populated)		D to B	+12 VDC
B	Power		D to E	2.5 VDC (±1 VDC)
C	(Not Populated)		D to F	2.5 VDC (±1 VDC)
D	Ground			
E	CAN High Signal			
F	CAN Low Signal			

Due to ISO terminators being Active as opposed to Passive like CAN terminators, it is very difficult to test for resistance.

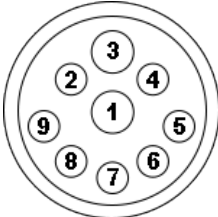
Pin	Description	Pin	Description	IBBC Connector	Pins	Multimeter Test
1	High Current Ground	6	CAN Power		1 to 3	+12 VDC
2	Logic Ground	7	CAN Ground		2 to 4	+12 VDC
3	High Current Power	8	CAN High Signal		6 to 7	+12 VDC
4	Logic Power	9	CAN Low Signal		7 to 8	2.5 VDC (±1 VDC)
5	(Not Populated)				7 to 9	2.5 VDC (±1 VDC)

Losing Nodes and/or Calibration

Losing Calibration

Has the field computer been updated recently?

Whenever updating a component in the system, it is recommended to make sure everything else in the system is also up to date to avoid any potential software compatibility issues.

Voltages and Wiring

Sudden drops in voltage can cause a node to lose calibration. This could be caused by a broken or pinched wire somewhere along the wiring. Test each connection to see where the problem wire may be.

Losing Nodes

Has the machine been jump-started recently?

Jump-starting a dead machine while the CAN/ISO system is still connected will cause a surge in voltage in the system. This will most often result in blown fuses.

Water in the CANBUS / ISOBUS

If water/corrosion is inside any point on the CAN/ISO line (typically through damaged/poor connections), the system can “act up” and have nodes going offline.

Voltage Dips and Spikes

If the machine’s electrical system is bad, the rise and fall in voltage will cause nodes to intermittently go offline.

Check CAN/ISO voltages to look for any dips and spikes in voltage.

Has the field computer been updated recently?

Whenever updating a component in the system, it is recommended to make sure everything else in the system is also up to date to avoid any potential software compatibility issues.

Possibility of Lightning Strike

Not very common, but has been known to happen. A lightning strike to the machine will usually damage nodes’ internal components.

The Micro 1Hz light will not be lit on most (if not all) nodes. Blown fuses will result in no HC / Logic lights.

Failed Node Updates

Common Causes

Improper Voltage to the Node

Machine Not Running During Update

The machine must be running to ensure the node receives a constant 12 volts during the update process.

Bad Ground in the Cabling

A faulty ground can cause sudden changes in voltage, resulting in a failed update.

USB Drive Issues

Storage Capacity Too Large

The field computer may not be able to properly launch the file from the USB because the drive's storage capacity is too large.



Faulty USB Drive

USB flash drives have a limit to how many times they may be rewritten. The quality of the USB drive will determine how many rewrites the drive can handle. As USB drives near the end of their life cycle, they begin transferring data much more slowly, which can lead to failures when updating software.

USB Drive Bumped or Removed During Update

Any interruptions caused to the USB drive during an update may cause the update to fail. Bumping or removing the USB drive during an update may also corrupt the update files, which will cause future updates to fail.

CANbus Issues

Faulty Voltage on the CANbus

High Current and Logic Power wires should have 12 volts. CAN High and CAN Low Signal wires should have approximately 2.5 volts (± 1 volt).

Damaged or Corroded Cabling

Cables may be pinched or severed or connectors may be damaged or have corrosion.

CAN Terminator(s) May Be Faulty, Disconnected, or Missing

A CANbus must contain 2 (and only 2) terminators.* One should be near the field computer / display / controller and the other should be at the opposite end of the CAN line.

*Hawkeye and SmarTrax MD contain their own CANbuses, so there may be more than 2 overall.

Wrong Node Software

Wrong Program Number

Download the software matrix sheet from the Raven Customer Portal for information on node program numbers needed for specific nodes.

Hardware Does Not Support the Software

One example of this is the SmartSteer node. SmartSteer and SmarTrax nodes* use the 269 program number, but SmartSteer cannot go beyond 6.0.17 software.

*However, SmarTrax MD uses the 339 program number.

Anhydrous / NH₃



AccuFlow



AccuFlow HP

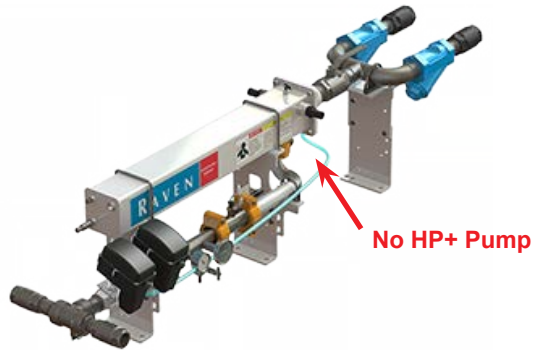

AccuFlow Vortex

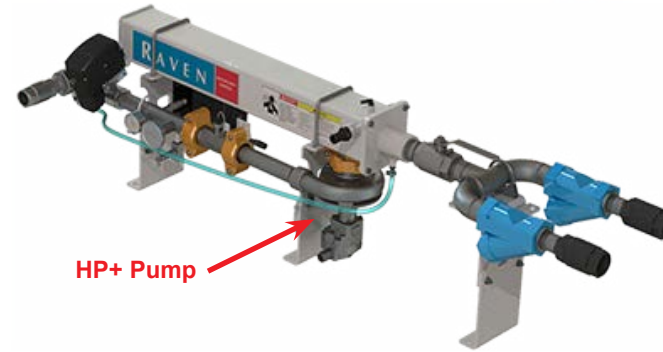

AccuFlow HP Plus

AccuFlow Rate Issues

Bouncing / Erratic Rate

Note: If the problem is suspected to be with the flow meter or the valve(s), traditional rate troubleshooting will apply.

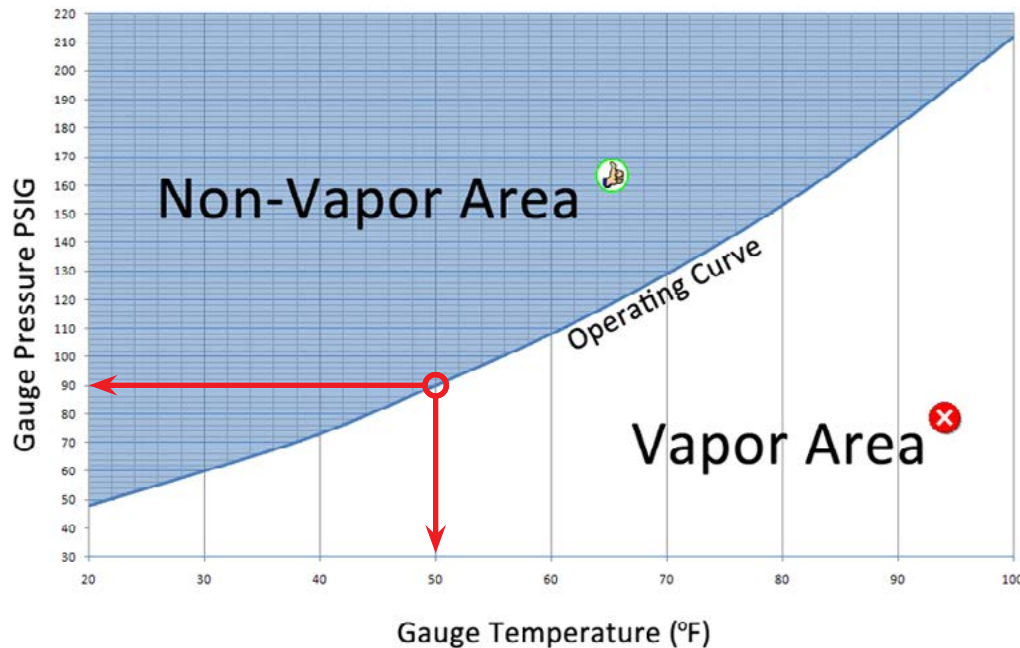

Proper Cooler Maintenance

Always make sure to regularly clean and inspect the components of the AccuFlow system. This will ensure that no restrictions will form from buildup, and will reduce the wear and tear on the system.

Vapor Through the Flow Meter

Vapor going through the flow meter will cause erratic flow readings which will result in the control valve needing to compensate for the rate changes.

Vapor is caused by:

- Pressure Loss
- Rise in Temperature

Make sure that you are operating within the non-vapor area according to the chart. When the outside temperature rises, it is often necessary to slow down to maintain a higher pressure in the system.

Flow Meter Blockage / Damage

Debris can sometimes slow down or completely block the turbine in the flow meter. This typically happens when the strainer is missing. In the worst case, debris can damage the flow meter turbine.

Damage to the flow meter is also often caused by running the nurse tank(s) empty. Pressure is still in the tank even when empty and it causes the turbine in the flow meter to spin faster than normal. This results in bearings wearing down rapidly and damage to the turbine shaft. It is not recommended to run nurse tanks to less than 5% capacity.

AccuFlow Rate Issues

Over-Application

The Meter Cal Is Incorrect

The most common cause of over-application with the AccuFlow system is that the meter cal has been entered incorrectly. The flow meter tag will have a separate meter cal number for NH₃ in pounds of “N.” For example, an RFM 60S will have a meter cal of 710, but the NH₃ meter cal would be 168.

If you do not have a tag but know the regular meter cal, divide the regular meter cal by 4.22 to set it for pounds of “N.”

The RFM 60S has very little variance from flow meter to flow meter, so a meter cal of 710 / 168 is a good starting point.

Basic Rate Troubleshooting

Off-rate issues with AccuFlow will use the same rate troubleshooting steps.

Uneven Application

Pinched / Collapsed Hoses

Hoses can often get pinched and even collapse at the manifolds. This will cause a restriction in some sections and excess flow through other sections. Replace any hoses as necessary and route them to where they will not pinch again.

NH₃ Through Tubes with Valves Closed & Green Streaks in the Field

NH₃ Coming Out Vapor Tubes When Valves Are Closed

Check Plumbing

Double check the plumbing on the system, especially if it is a new install.

Bad O-Rings / Gaskets

The internal O-rings may be bad. Replace as necessary.

Check Valve (For Multi-Section Setups)

A check valve must be installed between the cooler and the flow divider. When the manifold valves are closed, the pressure in the lines will cause leftover vapor and eventually liquid to come out of the vapor tubes.

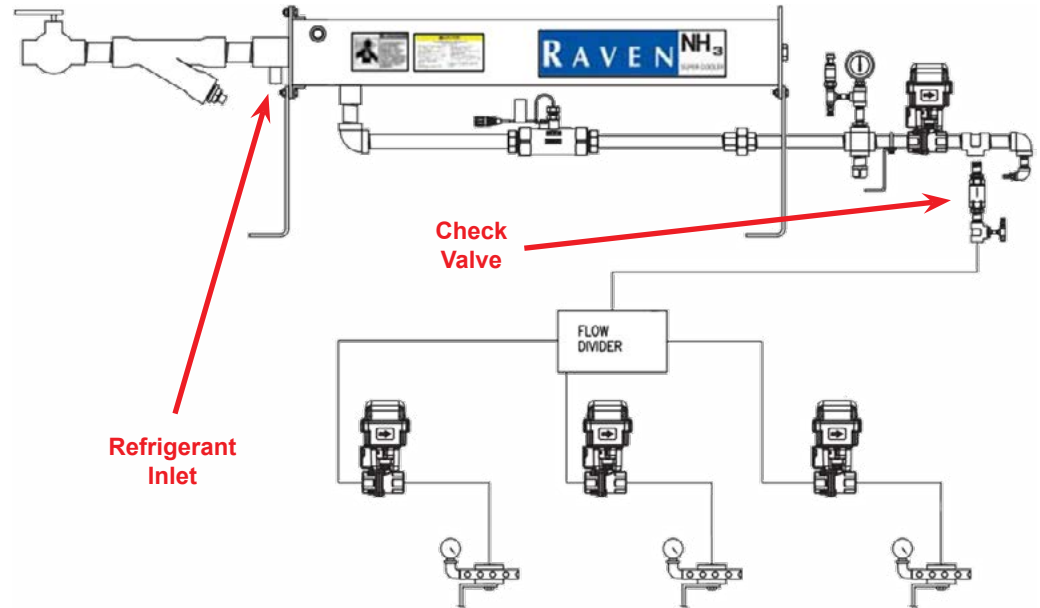

Green Streaks in the Field

Not Enough Restriction in Refrigerant Line

The green streaks in the field are primarily due to liquid coming out through the vapor tubes (more than described above). This is usually caused by there not being enough expansion due to inadequate restriction in the refrigerant inlet port.

Try using a smaller orifice to help restrict refrigerant flow into the inlet.

Frost Buildup



Possible Causes

- Pressure Loss
- Restrictions in Plumbing

Possible Fixes

Cleaning and Maintenance

- Refer to maintenance instructions in the operation manual for disassembly.
- Clean ports with compressed air or pipe brush.
- Check strainers and clean.

Plumbing

- Make sure the plumbing is not too restrictive (plumbing not too small and no unnecessary elbows).
- [How to Effectively Use the AccuFlow System](#)

Valve(s) Not Opening

Master On/Off and Section Valves

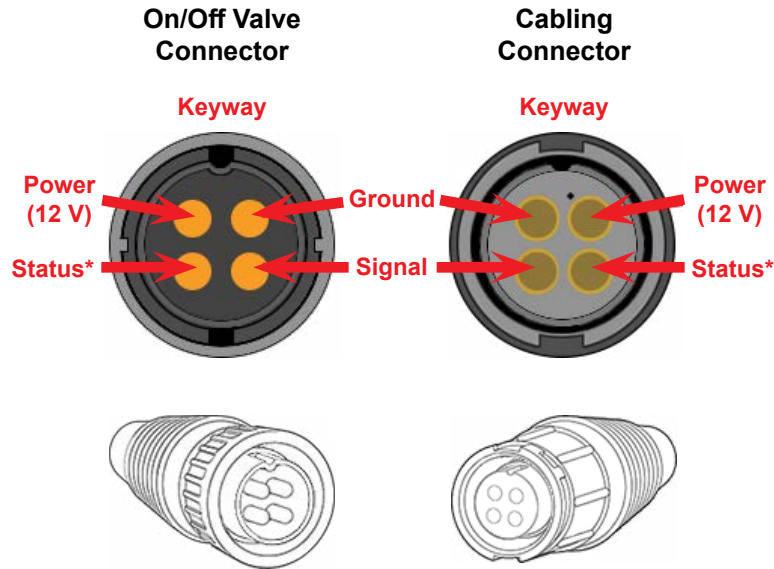

Control Valve

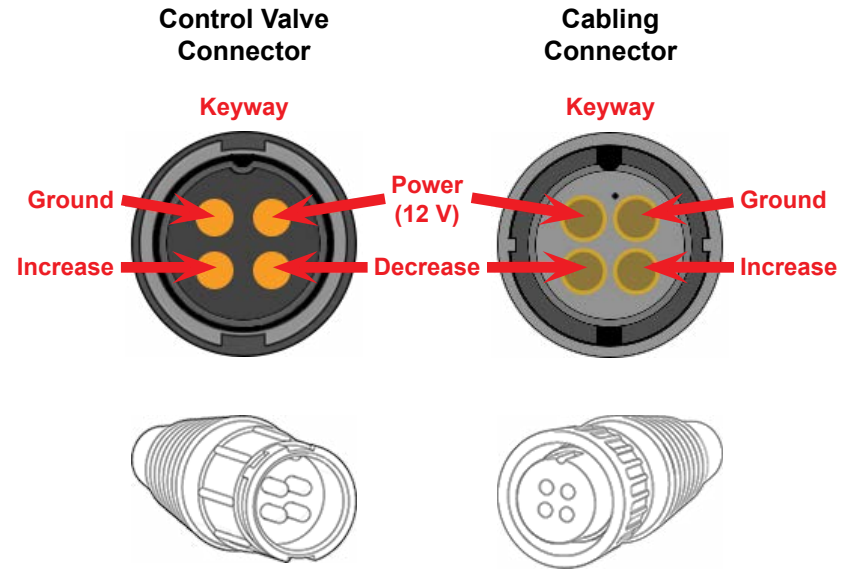

Control Valve Type

The control valve in a single valve system needs to be set to Fast Close (C-FC).

Check Power and Ground

Make sure the Power wire has 12 volts.

For On/Off valves, 12 volts applied to the Signal wire will open the valve while no voltage will close it.

Maintenance

Regularly clean and inspect all valves and strainers in the system.

*The Status pin is not populated in AccuFlow and AccuFlow HP cabling. It is only on Vortex and HP Plus cabling.

Injection



**High Volume
Sidekick Pump**



**High Volume
Sidekick Pro
Pump**

**Low Volume
Sidekick Pro
Pump**



**Low Volume
Sidekick Pump**

Sidekick Pro Node Lights

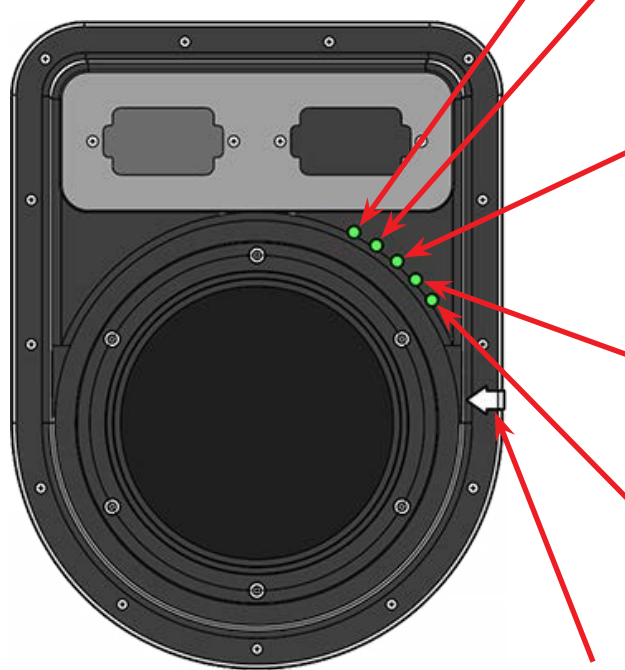

Light	Light Definition
Logic Power	The logic power indicator will be illuminated (solid) if logic power is present at the motor control node.
High Current Power	The high current indicator will be illuminated (solid) if high current power is present at the motor control node.
Micro 1Hz	The Micro 1Hz light indicates the node processor is communicating with the CANbus system. This indicator will flash: <ul style="list-style-type: none">• once per second if the motor control node is communicating via the CANbus.• four times per second if the motor control node cannot communicate via the CANbus.
Flow Switch State	The flow switch light will flash once per revolution of the injection pump shaft.
Calibration Switch State	The calibration switch light will flash when a metal object is passed by the internal calibration switch sensor. This can be engaged only after the CANbus control console (e.g. Viper Pro, Envizio Pro, SCS 4400, etc.) has calibrated the pump for the first time.

Calibration Switch

Priming and Calibration Issues

Times Out when Priming

The most common cause of a time-out when priming is because the pressure transducer needs to be calibrated. Priming will not work unless the pressure transducer detects **9 PSI** after the line is charged.

Also, make sure no air is being sucked into the system.

Pressure Transducer Calibration

1. Remove all pressure from the system.
2. Unscrew the transducer and leave it suspended to ensure it has a zero pressure reading. Leave the transducer power connected.
3. Navigate to the pressure settings for your console.

Envizio Pro



Viper 4



Viper Pro



ISO Systems

Tools/Settings Icon (Gears or Screwdriver with Wrench)

4. Enter a pressure cal of **0**.

Calibration Issues

Plunger Problems?

If the plunger is not rising completely or at all, lightly lubricate the plunger. Perform a catch test if the plunger still will not rise.

Chasing the Meter Cal?

The most common cause is the plunger may be sticking as it is trying to rise. Can either lubricate the plunger, or perform a catch test.

Easy Catch Test Method

1. Ready a measuring container. 1 gallon is preferred.
2. Set the pump to recirculate back to the tank.
3. Disconnect the recirculation line from the top of the tank and place it in the empty container.
4. Clear out the Total Volume from the controller.
5. Run the pump until 1 gallon has been caught.
6. Adjust the meter cal number accordingly.
7. Perform the test again.

Reconnect the tank recirculation line when finished.

$$\text{New Meter Cal} = \frac{\text{Current Meter Cal} \times \text{Total Volume (Controller)}}{\text{Actual Measured Volume}}$$

Operation Issues

Will Not Run

Must have the master switch and at least one boom switch in the ON position.

Sidekick (Older Style Pumps)

Unplug the tach feedback generator (2-pin Weatherpack). It should then run wide open. If it does not run wide open, the console cable may be hooked up backwards.

SCS Sidekick Console

[What to Check for on SCS Sidekick Pumps](#)

Sidekick Pro

Calibrate the pressure transducer(s).

Check the high current breaker on the battery connection.

See if there are any error messages when trying to run the pump. This can help point to what may be causing the issue.

Running Wide Open

Sidekick (Older Style Pumps)

Check for 9 volts from the tach feedback generator when the pump is running. Test this on the 2-pin Weatherpack connector coming from the generator (thin red and black wires). No voltage = bad tach generator.



Also, Make sure the console cable is connected correctly. This will affect the voltage readings on the tach feedback connector.

Inspect the tach belt to make sure it is not broken. Also make sure that it has not slipped out of place.

Inspect the pulleys along the tach belt to make sure that they are tight and not spinning freely.

SCS Sidekick Console

Check the settings in the console. If all settings are correct, the issue may be with the console itself.

Sidekick Pro

Not common. If it happens, verify boom associations, especially when running more than one pump.

Flow and Vac Alarms

Flow Alarm

Restriction in Shuttle/Piston Channel

The flow sensor may not be reading the shuttle/piston due to a restriction (debris, chemical buildup, etc.).

Regular pump maintenance will usually prevent this issue.

Flow Sensor out of Adjustment

The sensor is designed to have the line running vertically with the LED light on the left side of the line.

If the sensor appears as below but the light is not flashing, adjust the sensor while running the pump at its lowest injection rate (1 oz/min for 1-40 oz/min or 5 oz/min for 5-200 oz/min).

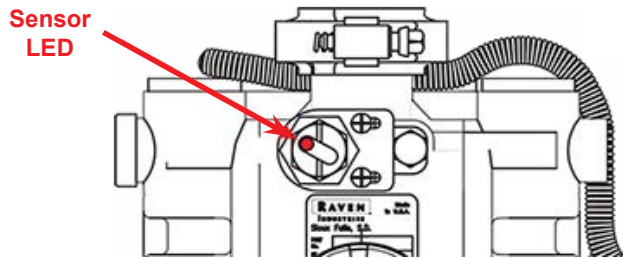

Pressure Transducer Needs Calibration

Other Flow Restrictions

- Make sure that the check valve is not too tight.
- Inspect the intake and discharge valve assemblies for bad o-rings, seals, or debris/buildup.

Vac Alarm

Test the Vacuum Switch

1. Disconnect the vacuum switch cable from the product cable.
2. On the cable attached to the vacuum switch (the female connector), test for continuity between pin A and pin C.
 - If the ohmmeter reads a short or 0 Ohms, the switch is good.
 - If it reads an open circuit or infinity, the switch is bad.

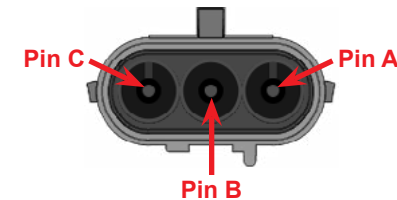

Inlet vs. Outlet Height

The line connected to the pump inlet must not raise chemical above 2 ft [0.6 m] from the chemical supply tank outlet.

Lines

Whenever possible, keep injection lines between the chemical tank and the pump under 5 ft [1.5 m] long.

Ensure that the line between the tank and pump inlet has an inside diameter of at least 3/4 in [1.9 cm].

Strainers and Valves

Inspect and clean the pump strainer. Also, check for obstructions in the injection line between the pump inlet and chemical supply tank.

Inspect and clean any other strainers or valves in the system.

Chemical Viscosity

Some chemicals can be too thick for the direct injection system. Depending on the type of chemical, it may be necessary to dilute the chemical before running it through the injection pump.

Hawkeye Nozzle Control



Nozzle Control Valve Lights

LED Activity	Rate	Color	State
Flashing	1 Hz	Green	Ready. If in actuating mode, the NCV is ready but requires calibration.
		Blue	Actuating Mode (Auto)
		Red	Loading New Software
		Amber	Alarm Active
	5 Hz	Amber	No ISOBUS Communication
Alternating	1 Hz	Blue/Green	Actuating Mode (Manual)
		Green/Magenta	Not Calibrated - Switch Input High
		Red/Magenta	Not Calibrated - Switch Input has not changed.
		Amber/Red	No ECU Detected or Invalid ISO Name
		Amber/Green	Ready - Warning Alarm Active
		Amber/Blue	Actuating mode - Warning Alarm Active
Solid	-	Any Color	Nozzle Control Valve Failure



1 Hz = Once per Second

5 Hz = Five Times per Second



Refer to the Hawkeye Calibration and Operation manual for additional help with diagnostic codes that occur along with the light conditions above.

Indexing Issues

NCV Count Troubleshooting

1. Visually inspect the NCV LEDs for power by the light color and blinking frequency.
2. On the boom cabling, disconnect all 19-pin boom cable connections, all 6-pin NCV connections, and terminator connections and visually inspect each for the following:
 - Corrosion
 - Pulled/pushed pins
 - Water
 - Broken wires
3. Reconnect all 19-pin boom cable connections. This will ensure that the entire boom nozzle-bus cabling is terminated on both ends.
4. Connect 5-10 NCVs on both the left and right boom cables. Start from the middle of the boom and work your way out.
5. Go into the Calibration Wizard and proceed until you get to the Nozzle Setup screen.

[Knowledge Article on How Indexing Works](#)

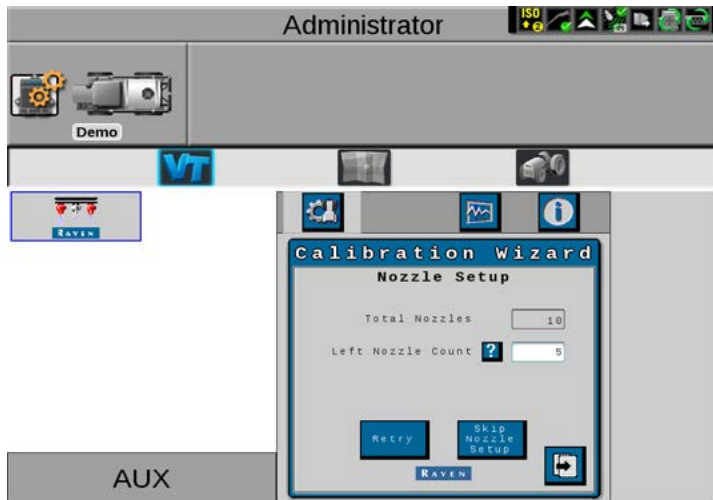

6. Verify the number of NCVs is correct, and ensure the correct number for the Left Nozzle Count. If the total number of nozzles on the left side does not match what you have installed, change the value on the VT to be accurate.

7. Go to the Diagnostic Info Tab and check the NCV CAN Errors line.

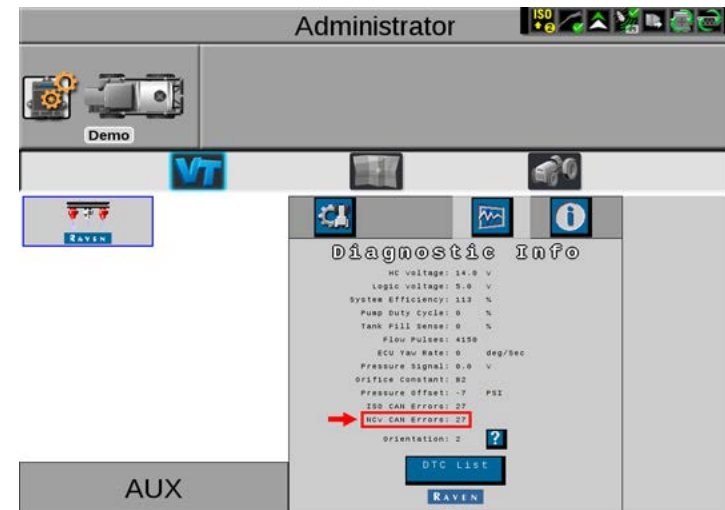

- If the number is stationary, the currently connected NCVs are good. Proceed to the next step.
 - If the number continues to count up, especially by a very large amount, the issue is with one or more of the currently connected NCVs. Disconnect all of the NCVs in the group you just connected and then reconnect them one at a time.
 - Each time you reconnect one of these NCVs, go back to the first tab, select the Retry button, and then verify the total nozzle count. Go to the Diagnostic Info tab again and check the NCV CAN error count to see if it is stationary or counting up. Continue this process until you locate the problem NCV/connection.
8. Reconnect 1 to 5 NCVs on each side of the boom.
 9. Go back to the first tab, select the Retry button, and then verify the total nozzle count. If the total number of nozzles on the left side does not match what you have installed, change the value on the VT to be accurate.
 10. Go to the Diagnostic Info tab again and check the NCV CAN error count to see if it is stationary or counting up (Step 7). Continue this process until you locate the problem NCV/connection.

Conventional Spraying Method

The Product Controller II ECU (Hawkeye ECU) is a dual function ECU. It can perform PWM based nozzle control with the Hawkeye Nozzle Control Valves (NCVs) as well as being able to spray in a conventional spray mode.

1. Access the check box to disable Hawkeye Nozzle Control.

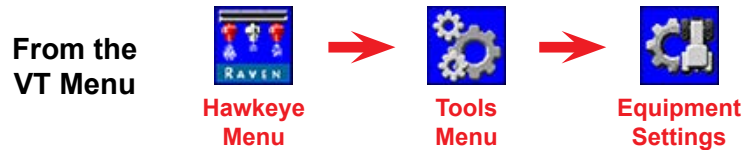

2. Set to conventional spraying based on the ECU firmware version.

2.0 and Below

Remove the check mark from the Nozzle Control box.

Note: If the Hawkeye ECU does not detect any NCVs on the ISOBUS, it will automatically remove the check mark for Nozzle Control.

2.1 and Above

Set the Operation Mode to **Bypass**.

3. Open the manual shut off valves on the conventional tip for each nozzle body when the Hawkeye Nozzle Control features are disabled.

Note: Nozzle Control features should only be disabled if the nozzle bodies on the implement are set to bypass the Hawkeye NCVs during operation. When Nozzle Control is disabled, the Hawkeye NCV will remain closed.

Harvest



SmartYield Pro Node



**Point Arrow Number 1
Upward**

Always mount the node "upward" so
the cables are at the bottom.

Current Tare vs. Current Darkness (% MS)

Current Tare Compensates for the “darkness” readings caused by the paddles crossing the optical sensors. Around 20% is normal.

Current Darkness (% MS) Percentage of time the paddles block the optical sensors. SmartYield Pro will zero this number after the Tare is calibrated.

Throughout the day, it may be necessary to recalibrate the tare additional times depending on the condition of the crop.

SmartYield



SmartYield Pro



Note: Make sure the sensors are reading completely off of the green portion of the paddle and not anywhere in the red. The Frequency reading will “bounce” if the sensors are mounted in between the green and red areas.

1. Have the harvester on level ground.
2. Run the harvester at normal threshing RPMs with the clean grain elevator completely empty. Run the clean grain elevator at maximum RPMs.
3. Select **Set Tare** (SmartYield) or **Start Calibration** (SmartYield Pro).
4. Check the Current Tare and Current Darkness / % MS to see if they are nearly the same number (SmartYield Pro will zero out the Current Darkness, so try to remember the value). If they are not, one of the following issues could be the cause:
 - The sensors are picking up on more than the elevator paddles (chain, bracket, etc.). Readjust the sensors as needed (in the green area and not the red).
 - The elevator chain may be too loose. Tighten as needed to the OEM specifications.
 - Paddles may be missing or damaged. SmartYield Pro can factor for up to 1 missing paddle. Any more missing paddles will cause issues.
5. Repeat this process 1 or 2 more times to verify the calibration.

Incorrect or No Header Height Reading

What to Check



Check for a change in voltage in the diagnostics screen when the header height is changed up or down. If there is no change in voltage, the cabling or sensor could be bad.

Inspect the sensor and cabling for any damage.

Always reset the Up and Down values for each crop. Changing between crops without resetting these values will cause issues such as not painting.

Most systems use a 360 degree header height sensor. There is only one deadband on the sensor, meaning the sensor will range from 0 volts to 4.5 volts, and once the sensor moves past the 4.5 volt position, it will pass over to the 0 volt position. This is demonstrated to the right. Make sure that when installing this type of sensor, that the it does will not cross this deadband point when raised or lowered.

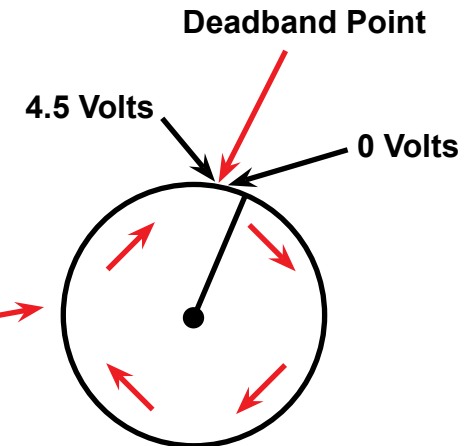

Note: The sensor can be installed in multiple ways. The voltage reading will depend on what you calibrate as “Up” and what you calibrate as “Down.”

Incorrect or No Moisture Reading

What to Check

Inspect the moisture sensor for any crop buildup. Buildup will most likely result in an incorrect moisture reading.

Check the Moisture Sensor Type.

Moisture Type	Used With
1	Original SmartYield and SmartYield to SmartYield Pro Upgrades
2	SmartYield Pro Systems

Check for Bad Cabling / Voltage.

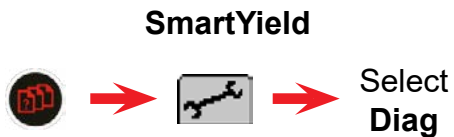

Voltage will display under **V3**. 0 volts could indicate a bad wire or sensor.

SmartYield Pro

Connection	Voltage
Red and White	12 V
Black and White	0-5 V
Blue and White	0-5 V

Inspect the sensor itself. Place your hand on the sensor and see if the moisture reading changes. If voltage is good but the reading doesn't change, the sensor is bad.

Other Recommendations

Smoothing

This value will usually default to 3 (smooths coverage every 3 seconds). It is recommended to set this to 1. It will have a minimal effect on job file size.

Number of Sections

Having more sections than needed will cause issues with yield values. It is recommended to have roughly 1 section for every 2 rows.

6 Rows = 3 Sections

Antenna Offset

Be sure to set the antenna offset from the cutter on the harvester head and not from the very front of the head. This will help with mapping, especially concerning the Yield Delay.

Yield Delay

Time between when the crop reaches the cutter on the harvester head to when it passes by the optical sensors in the clean grain elevator. Measure this time delay accurately and the map will be accurate as well.

Using the Yield Legend

The Envizio Pro is only capable of providing 6 ranges for yield. In order to get yield data into a more specific range (with more colors for yield ranges), an external GIS program will be needed. There are many free options online.

Set a Profile for Each Harvester Head

Oftentimes the bushels/acre are wrong when switching between crops because the machine now has a different head but with the profile from the old head (corn vs. beans). Setting a profile for each head will help avoid this.