



User Manual

INDUSTVILLE

INTRODUCTION

Important - Please read these instructions carefully before assembly to ensure safe and satisfactory operation of these products. Please also retain these instructions for future use. If you need help please call our Customer Support on 0207 7971 7871

Thank you for shopping with Industville. This manual is designed to help you through each step of owning your new light fitting, from installation to use.

Please read it carefully before you start using your product, as we have endeavored to answer as many questions as possible, and provide you with as much support as we can. If, however, you should find something missing, or not covered, please contact our Customer Care team on **0207 7971 7871**.

Warranty

Your new Industville Light comes with our 12-month guarantee, protecting you against electrical and mechanical breakdown. For full terms & conditions, refer to the website on the back of this book.

Returns

Our policy for refund or exchange lasts 14 days. If 14 days have gone since the product was delivered to you, unfortunately we can't offer you a refund or exchange.

To be eligible for a return, you must return the item to the address below and notify us within 14 days since delivery via email: info@industville.co.uk

Your Item (s) must be unused and in the same condition that you received it. It must also be in the original packaging.

Please note that goods remain your property until they have been checked and must be complete with ALL original packaging which MUST be intact and suitable for resale.

Should goods fail the inspection they will remain your property and you will be responsible for their collection. We therefore recommend that you adequately insure the goods during transit and put into another box or wrap well to protect the original packaging.

We don't offer refund for bespoke products made to customer's specifications

To complete your return, we require a copy of receipt or proof of purchase sent together with the item. There are certain situations where only partial refunds are granted, i.e. any item not in its original condition, is damaged or missing parts for reasons not due to our error

Refunds

Once your return is received and inspected, we will send you an email to notify you that we have received your returned item. We will also notify you of the approval or rejection of your refund.

If you are approved, then your refund will be processed, and a credit will automatically be applied to your credit card or original method of payment, within 5-7 days.

You will be responsible for paying for your own shipping costs for returning your item. We will also charge £9 admin fee to cover the original shipping. If you receive a refund, the cost of return shipping will be deducted from your refund.

Exchange

- We will replace items if they are defective or damaged in transport.
- We'll require photos of the damaged item, showing the detail of the product as the whole and also the damaged packaging.
- You need to notify us within 14 days of delivery. If 14 days have gone by since the product was delivered to you, unfortunately we can't offer you a refund or exchange.
- If you need to exchange the item, send us an email at info@industville.co.uk and we'll proceed with an exchange asap. We'll arrange a collection of the item and send you another one.
- Exchange for another item if you change your mind
- We will replace items if you change your mind.
- You need to notify us within 14 days of delivery. If 14 days have gone by since the product was delivered to you, unfortunately we can't offer you a refund or exchange.
- If you need to exchange for another item, send us an email at info@industville.co.uk and we'll proceed with an exchange asap. You will be responsible for paying for your own shipping costs when returning your item. We will also charge £9 admin fee to cover the exchange shipping.
- We recommend to return your item with track-able shipping service or purchasing shipping insurance. If it gets lost, we won't be able to provide a refund.



WARNING

Important-We recommend installation by a licensed electrician

SAFETY WARNING

Important - We recommend installation by a licensed electrician

Safety information

- This product is produced in conformity with all relevant safety regulations relating to electrical appliances. If In doubt about fitting this product, please consult a qualified electrician.
- Carefully unpack and examine the products for any damage. If you think there is a defect, do not use and contact our customer services on 0207 7971 7871
- Do not modify or alter any product before or after installation. This may render the product unsafe.
- Ensure the power is switched off before cleaning or carrying out any maintenance
- Unless otherwise stated our light fittings are only suitable for indoor use and must not be installed in areas where they may be subjected to high humidity or water
- Check old wires hanging from junction box for wear or fraying before installing your new light. Do not attach your new light fixture wiring to any old wiring that shows signs of wear, including frays or burn marks. This may be a fire hazard and may also necessitate calling an electrician.

Maintenance and cleaning

Caution - Always disconnect power supply when servicing or cleaning

- Use a clean dry soft cloth
- Do not use abrasive cloths or polishes as this may cause damage to the product
- Glass shades should be only washed with in lukewarm water and dried thoroughly before refitting.

Changing the bulb

- Ensure that the bulb has cooled down before replacing
- Ensure that the power supply has be disconnected
- Check old wires hanging from junction box for wear or fraying before installing your new light. Do not attach your new light fixture wiring to any old wiring that shows signs of wear, including frays or burn marks. This may be a fire hazard and may also necessitate calling an electrician.

WHAT YOU WILL NEED



Wire Cutter/Stripper



Flat Head Screw Driver



Pliers



5a termination strip



Insulation tape



Mounting Screws

PARTS

Listed below are parts that have been referenced throughout this manual. All included with your Industville purchase.

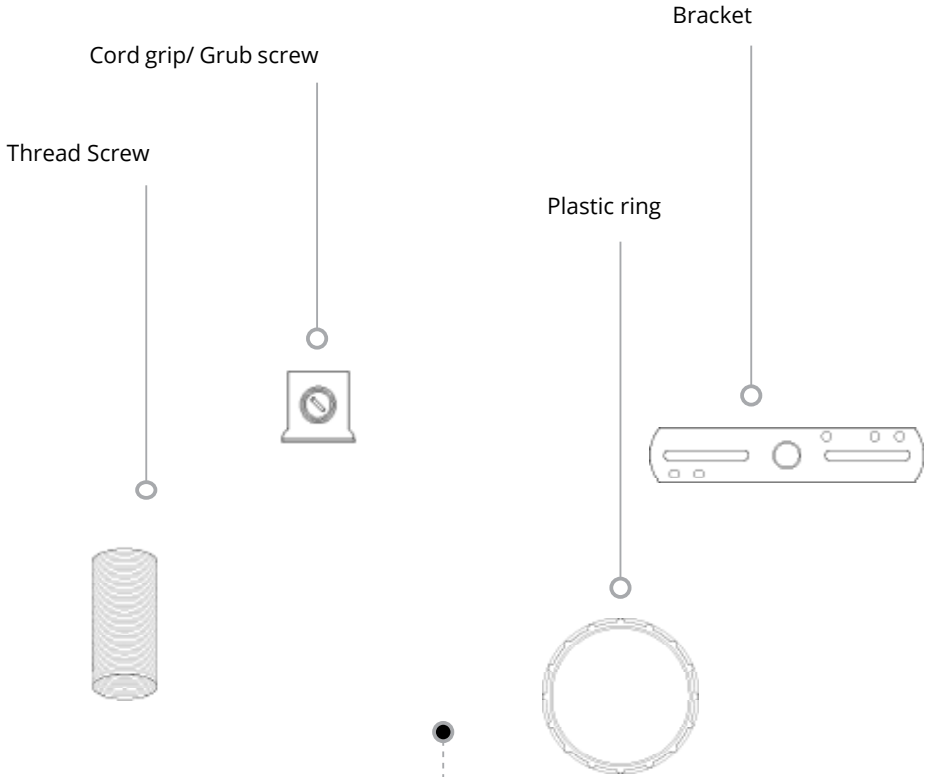

Please note: the design may vary slightly.
If any of the above items are missing or damaged.
Please contact our support team on
0207 7971 7871.

INSTALLATION

Installing brackets



1.

First make a fitting as illustrated in image 1. by inserting the thread screw through the middle



2.

Connect the wire of lamp with the mains wire like image.2 by passing it through the 1 inch threaded tube.



3.

Then affix the bracket on the ceiling rose by using the appropriate screws. After that rotate the ceiling rose on the 1 inch threaded tube till it reaches the position as in image.3



4.

Then use the chord grip like image. 4 to hold the wire on the ceiling rose.

CONTENTS

1.

Brooklyn Pendants

Brooklyn Antique Flat - 8 inch	11
Brooklyn Antique Flat -15 inch	12
Brooklyn Vintage Umbrella	17
Brooklyn Vintage Small Dome - 8 inch	20
Brooklyn Vintage Small Cone - 7 inch	23
Brooklyn Vintage Ribbed Glass - Dome	26
Brooklyn Vintage Ribbed Glass - Funnel	29
Brooklyn Vintage Antique Ribbed Glass Retro Dome Pendant- 12 inch.....	32
Brooklyn Vintage Cone - 12inch	38
Brooklyn Vintage Dome - 13 inch	41
Brooklyn Vintage Giant Bell	44
Brooklyn Vintage Giant Hat	47
Brooklyn Vintage Step -16 Inch	50
Brooklyn Vintage Giant Step -18 inch.....	53
Brooklyn Vintage Metal Giant Dome - 23.5 Inch	56
Brooklyn Vintage Giant Bowl Metal Lampshade - Dark Pewter - 24 inch	59

2.

Pendants

Orlando Vintage Cage Pendant.....	62
Orlando Cylinder Wire Cage Pendant	65
Orlando Balloon Wire Cage Pendant.....	65
Old Factory Pendant.....	68
Large Retro Industrial Pendant - 17 inch / 13inch	77
Retro Enamel Cage Pendant Light in Grey - 14 inch.....	83
Vintage Motorcycle Funky Pendant Light - 17cm.....	89

Handcrafted Unique Vintage Cage Wire Metal Pendant Light - Drop.....	111
Handcrafted Unique Vintage Cage Wire Metal Pendant Light - Round.....	114
Handcrafted Unique Vintage Cage Wire Metal Pendant Light - Cone.....	117

3. **Wall Lights**

Brooklyn Vintage Antique Sconce- Flat	135
Brooklyn Vintage Antique Sconce- Umbrella.....	138
Brooklyn Vintage Antique Sconce- Cone.....	141
Brooklyn Vintage Antique Sconce- Dome	144
Brooklyn Vintage Antique Ribbed Glass Retro Funnel	147
Brooklyn Vintage Antique Glass sconce Wall Lamp	150
Orlando Vintage Wire Cage Retro Sconce.....	153
Orlando Cylinder Cage Retro Wall Sconce.....	156
Orlando Balloon Cage Retro Sconce	159
Vintage Round Shaped Barn Swan Neck Retro Wall Sconce Lamp.....	162
Vintage Cone Shaped Barn Swan Neck Retro Wall Sconce.....	165
Vintage Adjustable Swivel Spotlight - Single	168
Vintage Adjustable Swivel Spotlight - Double	171

4. **Bulkheads**

Vintage Industrial Oval Heavy Bulkhead Retro Wall Light/Flush Mount	174
Vintage Industrial Heavy Round Bulkhead Retro Wall Light/Flush Mount	177
Vintage Industrial Cage Bulkhead Wall Light Sconce with Glass - 30 cm	180
Vintage Industrial Cage Bulkhead Wall Light Sconce with Glass - 30 cm.....	183

5. **Flush mounts**

Vintage Industrial Barn Flushmount ceiling	186
Vintage Industrial Barn Slotted Mount ceiling.....	189
Vintage Industrial Flush mount Farmhouse	192
Vintage Marine Cage Flushmount	195

6.

Holders

BrooklynHolders.....	195
Brooklyn Vintage ES E27 Bulb Holder.....	198
Brooklyn Vintage Lamp Shade Cord Set ES E27 Bulb Holder.....	101
Brooklyn Vintage 5 Wire Pendant Light.....	104
Vintage Lamp Shade Cord Set ES E27 Bulb Holder - Dark Pewter with Chain.....	107

PENDANT LIGHTS - BROOKLYN ANTIQUE FLAT - 8 INCH

All of Industville designs are authentic and unique, having been inspired by the industrial and factory lighting of the late nineteenth and early twentieth century. Designed to reflect the true utilitarian function of this lighting style with classic lines and exposed hardware; they show the same attention to detail required for their original industrial purpose. At Industville, we endeavour to produce products that effectively combine good design and exceptional value without compromising quality. Perfect to bring vintage charm and the industrial look and feel into any interior space.

As with all our light fittings, Industville offers a huge range of sizes and options, including a variety of holders, finishes and up to 30 different fabric flex variations, in addition to a variety of energy efficient LED filament bulbs, to enable you to tailor your lighting choices to any style or size of project.

The strength of our company lies in the fact that our products are available in large numbers and offer the look and feel of vintage, retro industrial lighting without the cost and time-constraints of searching for originals. Nevertheless, as they are all hand finished by our skilled craftsmen in our dedicated factory, therefore all our products retain a unique and individual quality which remains true to the ethos and appeal of industrial lighting.

Electrical Installation

- Ensure the electrical supply is switched off
- Ensure that the electrical circuit to which this fitting is to be connected has been installed and fused in accordance with current IEE wiring regulations, BS7671.
- Products must also be installed in accordance with UK Building Regulations where applicable.
- Position the fitting where desired and confirm the method of fixing which will be required: wood screw for wood, or wood screw/ wall plug for brick and masonry
- Carefully identify the location of the mains supply cable and any other cables in the area in which you intend to fix the lamp in order to avoid damage during installation.
- Carefully support the holder during the following wiring/ connection procedure.
- Using the connector block supplied, carefully connect your lamp to the housing wiring as detailed in the following diagram

Household supply

Light Fitting

Neutral Loop - Blue or black

Earth Loop - Green/Yellow sleeved Copper

Switch Wires- Blue with Brown sheathing or
(Black with Red Sheathing)

Live Loop- Brown or (Red)

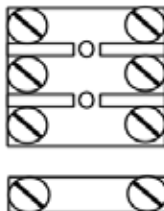

Blue(N)

Green/Yellow

Brown

No connection
to light fitting

Electrical Installation - Continued

- Double check that all connections are tight. Ensure that the inner insulation is only stripped back sufficient to make a good contact in the terminal block.
- Carefully bind the terminal block and the cable either side with insulation tape (not supplied) ensuring that tape fully covers the cable to beyond the point where the outer insulation has been stripped.
- Install the mounting bracket using mounting screws (screws not provided, please refer to page 7)
- Screw the threaded rod from the ceiling rose to the mounting bracket and secure into place.

Assembly

The ceiling fittings are completely pre wired and only require a small amount of assembly after connection to the mains wiring:

- Once the pendant holder is installed, unscrew the black ring (see page 6)
- Hold the shade in place
- Once in place begin to screw the black ring.
- Once secure it will hold the shade to the holder, your Brooklyn Pendant is now installed.

SPECIFICATIONS

Category

We meet all UK and EU lighting and safety regulations.

Edison screw E27 lamp-holders are fitted as standard.

All pendants are supplied complete with fitting – this includes bulb holder, ceiling rose and 1M/39" of high quality black fabric flex (shade only option is available).

Material of shade: Steel

Please note: all our products are hand finished to ensure an authentic vintage look and therefore they may vary slightly from those shown in the images.

Finishes available:

Holder: Antique Brass, Dark Pewter, Copper

Shade: Dark Pewter, Antique Brass, Copper

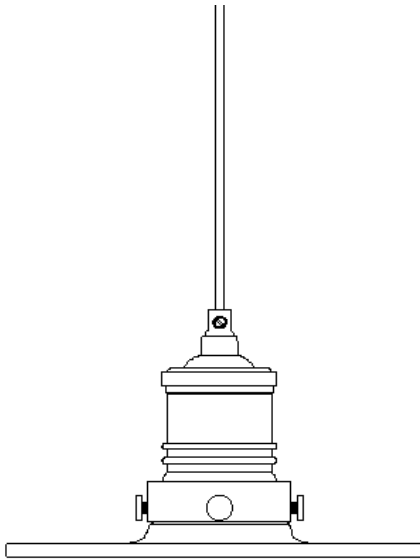

Dimensions:

Diameter: 21cm / 8"

Height: 16.5cm / 6.5"

PENDANT LIGHTS - BROOKLYN ANTIQUE FLAT -15 INCH

All of Industville designs are authentic and unique, having been inspired by the industrial and factory lighting of the late nineteenth and early twentieth century. Designed to reflect the true utilitarian function of this lighting style with classic lines and exposed hardware; they show the same attention to detail required for their original industrial purpose. At Industville, we endeavour to produce products that effectively combine good design and exceptional value without compromising quality. Perfect to bring vintage charm and the industrial look and feel into any interior space.

As with all our light fittings, Industville offers a huge range of sizes and options, including a variety of holders, finishes and up to 30 different fabric flex variations, in addition to a variety of energy efficient LED filament bulbs, to enable you to tailor your lighting choices to any style or size of project.

The strength of our company lies in the fact that our products are available in large numbers and offer the look and feel of vintage, retro industrial lighting without the cost and time-constraints of searching for originals. Nevertheless, as they are all hand finished by our skilled craftsmen in our dedicated factory, therefore all our products retain a unique and individual quality which remains true to the ethos and appeal of industrial lighting.

Electrical Installation

- Ensure the electrical supply is switched off
- Ensure that the electrical circuit to which this fitting is to be connected has been installed and fused in accordance with current IEE wiring regulations, BS7671.
- Products must also be installed in accordance with UK Building Regulations where applicable.
- Position the fitting where desired and confirm the method of fixing which will be required: wood screw for wood, or wood screw/ wall plug for brick and masonry
- Carefully identify the location of the mains supply cable and any other cables in the area in which you intend to fix the lamp in order to avoid damage during installation.
- Carefully support the holder during the following wiring/ connection procedure.
- Using the connector block supplied, carefully connect your lamp to the housing wiring as detailed in the following diagram

Household supply

Neutral Loop - Blue or black

Earth Loop - Green/Yellow sleeved Copper

Switch Wires- Blue with Brown sheathing or
(Black with Red Sheathing)

Live Loop- Brown or (Red)

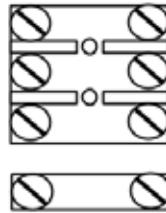

Light Fitting

Blue(N)

Green/Yellow

Brown

No connection
to light fitting

Electrical Installation - Continued

- Double check that all connections are tight. Ensure that the inner insulation is only stripped back sufficient to make a good contact in the terminal block.
- Carefully bind the terminal block and the cable either side with insulation tape (not supplied) ensuring that tape fully covers the cable to beyond the point where the outer insulation has been stripped.
- Install the mounting bracket using mounting screws (Not provided, please refer to page 7)
- Screw the threaded rod from the ceiling rose to the mounting bracket and secure into place.

Assembly

These ceiling fitting are completely pre wired and only require a small amount of assembly after connection to the mains wiring as follows:

- Once the pendant holder is installed, unscrew the black ring (see page 6)
- Hold the shade in place
- Once in place begin to screw the black ring.
- Once secure it will hold the shade to the holder, your Brooklyn Pendant is now installed.

SPECIFICATIONS

Category

We meet all UK and EU lighting and safety regulations.

Edison screw E27 lamp-holders are fitted as standard.

All pendants are supplied complete with fitting – this includes bulb holder, ceiling rose and 1M/39" of high quality black fabric flex (shade only option is available).

Material of shade: Steel

Please note: all our products are hand finished to ensure an authentic vintage look and therefore they may vary slightly from those shown in the images.

Finishes available:

Holder: Antique Brass, Dark Pewter, Copper

Shade: Dark Pewter, Antique Brass, Copper

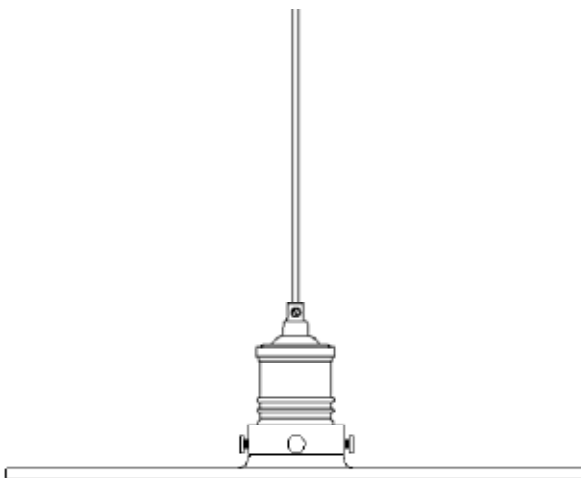

Dimensions:

Diameter: 38.5cm / 15"

Height: 16.5cm / 6.5"

PENDANT LIGHTS - BROOKLYN VINTAGE UMBRELLA

All of Industville designs are authentic and unique, having been inspired by the industrial and factory lighting of the late nineteenth and early twentieth century. Designed to reflect the true utilitarian function of this lighting style with classic lines and exposed hardware; they show the same attention to detail required for their original industrial purpose. At Industville, we endeavour to produce products that effectively combine good design and exceptional value without compromising quality. Perfect to bring vintage charm and the industrial look and feel into any interior space.

As with all our light fittings, Industville offers a huge range of sizes and options, including a variety of holders, finishes and up to 30 different fabric flex variations, in addition to a variety of energy efficient LED filament bulbs, to enable you to tailor your lighting choices to any style or size of project.

The strength of our company lies in the fact that our products are available in large numbers and offer the look and feel of vintage, retro industrial lighting without the cost and time-constraints of searching for originals. Nevertheless, as they are all hand finished by our skilled craftsmen in our dedicated factory, therefore all our products retain a unique and individual quality which remains true to the ethos and appeal of industrial lighting.

Electrical Installation

- Ensure the electrical supply is switched off
- Ensure that the electrical circuit to which this fitting is to be connected has been installed and fused in accordance with current IEE wiring regulations, BS7671.
- Products must also be installed in accordance with UK Building Regulations where applicable.
- Position the fitting where desired and confirm the method of fixing which will be required: wood screw for wood, or wood screw/ wall plug for brick and masonry
- Carefully identify the location of the mains supply cable and any other cables in the area in which you intend to fix the lamp in order to avoid damage during installation.
- Carefully support the holder during the following wiring/ connection procedure.
- Using the connector block supplied, carefully connect your lamp to the housing wiring as detailed in the following diagram

Household supply

Light Fitting

Neutral Loop - Blue or black

Earth Loop - Green/Yellow sleeved Copper

Switch Wires- Blue with Brown sheathing or
(Black with Red Sheathing)

Live Loop- Brown or (Red)

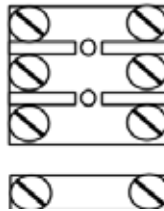

Blue(N)

Green/Yellow

Brown

No connection
to light fitting

Electrical Installation - Continued

- Double check that all connections are tight. Ensure that the inner insulation is only stripped back sufficient to make a good contact in the terminal block.
- Carefully bind the terminal block and the cable either side with insulation tape (Not supplied) Ensuring that tape fully covers the cable to beyond the point where the outer insulation has been stripped.
- Install the mounting bracket using mounting screws (screws not provided, please refer to page 7)
- Screw the threaded rod from the ceiling rose to the mounting bracket and secure into place.

Assembly

These ceiling fitting are completely pre wired and only require a small amount of assembly after connection to the mains wiring as follows:

- Once the pendant holder is installed, unscrew the black ring (see page 6)
- Hold the shade in place onto the holder
- Once in place begin to screw the black ring.
- Once secure it will hold the shade to the holder, your Brooklyn Pendant is now installed.

SPECIFICATIONS

Category

We meet all UK and EU lighting and safety regulations.

Edison screw E27 lamp-holders are fitted as standard.

All pendants are supplied complete with fitting – this includes bulb holder, ceiling rose and 1M/39" of high quality black fabric flex (shade only option is available).

Material of shade: Steel

Please note: all our products are hand finished to ensure an authentic vintage look and therefore they may vary slightly from those shown in the images.

Finishes available:

Holder: Antique Brass, Dark Pewter, Copper

Shade: Dark Pewter, Antique Brass

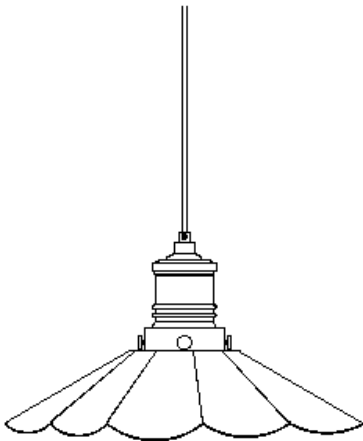

Dimensions:

Diameter: 20cm / 8"

Height: 16.5cm / 6.5"

PENDANT LIGHTS - BROOKLYN VINTAGE SMALL DOME - 8 INCH

All of Industville designs are authentic and unique, having been inspired by the industrial and factory lighting of the late nineteenth and early twentieth century. Designed to reflect the true utilitarian function of this lighting style with classic lines and exposed hardware; they show the same attention to detail required for their original industrial purpose. At Industville, we endeavour to produce products that effectively combine good design and exceptional value without compromising quality. Perfect to bring vintage charm and the industrial look and feel into any interior space.

As with all our light fittings, Industville offers a huge range of sizes and options, including a variety of holders, finishes and up to 30 different fabric flex variations, in addition to a variety of energy efficient LED filament bulbs, to enable you to tailor your lighting choices to any style or size of project.

The strength of our company lies in the fact that our products are available in large numbers and offer the look and feel of vintage, retro industrial lighting without the cost and time-constraints of searching for originals. Nevertheless, as they are all hand finished by our skilled craftsmen in our dedicated factory, therefore all our products retain a unique and individual quality which remains true to the ethos and appeal of industrial lighting.

Electrical Installation

- Ensure the electrical supply is switched off
- Ensure that the electrical circuit to which this fitting is to be connected has been installed and fused in accordance with current IEE wiring regulations, BS7671.
- Products must also be installed in accordance with UK Building Regulations where applicable.
- Position the fitting where desired and confirm the method of fixing which will be required: wood screw for wood, or wood screw/ wall plug for brick and masonry
- Carefully identify the location of the mains supply cable and any other cables in the area in which you intend to fix the lamp in order to avoid damage during installation.
- Carefully support the holder during the following wiring/ connection procedure.
- Using the connector block supplied, carefully connect your lamp to the housing wiring as detailed in the following diagram

Household supply

Light Fitting

Neutral Loop - Blue or black

Earth Loop - Green/Yellow sleeved Copper

Switch Wires- Blue with Brown sheathing or
(Black with Red Sheathing)

Live Loop- Brown or (Red)

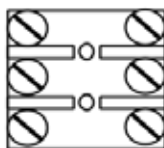

Blue(N)

Green/Yellow

Brown

No connection
to light fitting



Electrical Installation - Continued

- Double check that all connections are tight. Ensure that the inner insulation is only stripped back sufficient to make a good contact in the terminal block.
- Carefully bind the terminal block and the cable either side with insulation tape (Not supplied) Ensuring that tape fully covers the cable to beyond the point where the outer insulation has been stripped.
- Install the mounting bracket using mounting screws (screws not provided, please refer to page 7)
- Screw the threaded rod from the ceiling rose to the mounting bracket and secure into place.

Assembly

These ceiling fitting are completely pre wired and only require a small amount of assembly after connection to the mains wiring as follows:

Once the pendant holder is installed, unscrew the black ring (see page 6)

- Hold the shade in place onto the holder
- Once in place begin to screw the black ring.
- Once secure it will hold the shade to the holder, your Brooklyn Pendant is now installed.

SPECIFICATIONS

Category

We meet all UK and EU lighting and safety regulations.

Edison screw E27 lamp-holders are fitted as standard.

All pendants are supplied complete with fitting – this includes bulb holder, ceiling rose and 1M/39" of high quality black fabric flex (shade only option is available).

Material of shade: Steel.

Please note: all our products are hand finished to ensure an authentic vintage look and therefore they may vary slightly from those shown in the images.

Finishes available:

Holder: Antique Brass, Dark Pewter, Copper

Shade: Dark Pewter, Antique Brass

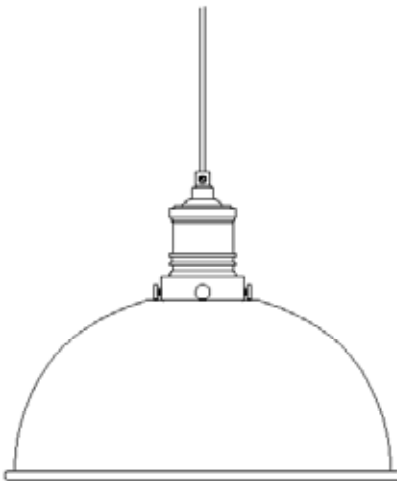

Dimensions:

Diameter: 21cm / 8"

Height: 21cm / 8"

PENDANT LIGHTS - BROOKLYN VINTAGE SMALL CONE- 7 INCH

All of Industville designs are authentic and unique, having been inspired by the industrial and factory lighting of the late nineteenth and early twentieth century. Designed to reflect the true utilitarian function of this lighting style with classic lines and exposed hardware; they show the same attention to detail required for their original industrial purpose. At Industville, we endeavour to produce products that effectively combine good design and exceptional value without compromising quality. Perfect to bring vintage charm and the industrial look and feel into any interior space.

As with all our light fittings, Industville offers a huge range of sizes and options, including a variety of holders, finishes and up to 30 different fabric flex variations, in addition to a variety of energy efficient LED filament bulbs, to enable you to tailor your lighting choices to any style or size of project.

The strength of our company lies in the fact that our products are available in large numbers and offer the look and feel of vintage, retro industrial lighting without the cost and time-constraints of searching for originals. Nevertheless, as they are all hand finished by our skilled craftsmen in our dedicated factory, therefore all our products retain a unique and individual quality which remains true to the ethos and appeal of industrial lighting.

Electrical Installation

- Ensure the electrical supply is switched off
- Ensure that the electrical circuit to which this fitting is to be connected has been installed and fused in accordance with current IEE wiring regulations, BS7671.
- Products must also be installed in accordance with UK Building Regulations where applicable.
- Position the fitting where desired and confirm the method of fixing which will be required: wood screw for wood, or wood screw/ wall plug for brick and masonry
- Carefully identify the location of the mains supply cable and any other cables in the area in which you intend to fix the lamp in order to avoid damage during installation.
- Carefully support the holder during the following wiring/ connection procedure.
- Using the connector block supplied, carefully connect your lamp to the housing wiring as detailed in the following diagram

Household supply

Light Fitting

Neutral Loop - Blue or black

Earth Loop - Green/Yellow sleeved Copper

Switch Wires- Blue with Brown sheathing or
(Black with Red Sheathing)

Live Loop- Brown or (Red)

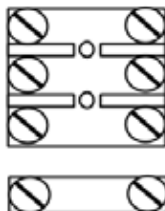

Blue(N)

Green/Yellow

Brown

No connection
to light fitting

Electrical Installation - Continued

- Double check that all connections are tight. Ensure that the inner insulation is only stripped back sufficient to make a good contact in the terminal block.
- Carefully bind the terminal block and the cable either side with insulation tape (Not supplied) Ensuring that tape fully covers the cable to beyond the point where the outer insulation has been stripped.
- Install the mounting bracket using mounting screws (screws not provided, please refer to page 7)
- Screw the threaded rod from the ceiling rose to the mounting bracket and secure into place.

Assembly

These ceiling fitting are completely pre wired and only require a small amount of assembly after connection to the mains wiring as follows:

- Once the pendant holder is installed, unscrew the black ring (see page 6)
- Hold the shade in place onto the holder
- Once in place begin to screw the black ring.
- Once secure it will hold the shade to the holder, your Brooklyn Pendant is now installed.

SPECIFICATIONS

Category

We meet all UK and EU lighting and safety regulations.

Edison screw E27 lamp-holders are fitted as standard.

All pendants are supplied complete with fitting – this includes bulb holder, ceiling rose and 1M/39" of high quality black fabric flex (shade only option is available).

Dimensions include any shades supplied complete with fitting.

Please note: all our products are hand finished to ensure an authentic vintage look and therefore they may vary slightly from those shown in the images.

Finishes available:

Holder: Antique Brass, Dark Pewter, Copper

Shade: Dark Pewter, Antique Brass, Copper

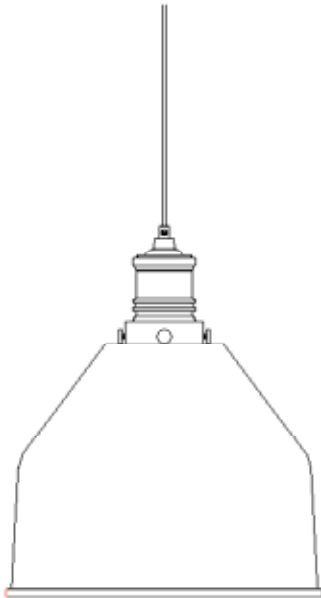

Dimensions:

Diameter: 17cm / 7"

Height: 27cm / 10.5"

PENDANTS -

BROOKLYN VINTAGE ANTIQUE RIBBED GLASS RETRO DOME PENDANT - 8 INCH

All of Industville designs are authentic and unique, having been inspired by the industrial and factory lighting of the late nineteenth and early twentieth century. Designed to reflect the true utilitarian function of this lighting style with classic lines and exposed hardware; they show the same attention to detail required for their original industrial purpose. At Industville, we endeavor to produce products that effectively combine good design and exceptional value without compromising quality. Perfect to bring vintage charm and the industrial look and feel into any interior space.

As with all our light fittings, Industville offers a huge range of sizes and options, including a variety of holders, finishes and up to 30 different fabric flex variations, in addition to a variety of energy efficient LED filament bulbs, to enable you to tailor your lighting choices to any style or size of project.

The strength of our company lies in the fact that our products are available in large numbers and offer the look and feel of vintage, retro industrial lighting without the cost and time-constraints of searching for originals. Nevertheless, as they are all hand finished by our skilled craftsmen in our dedicated factory, therefore all our products retain a unique and individual quality which remains true to the ethos and appeal of industrial lighting.

Electrical Installation

- Ensure the electrical supply is switched off
- Ensure that the electrical circuit to which this fitting is to be connected has been installed and fused in accordance with current IEE wiring regulations, BS7671.
- Products must also be installed in accordance with UK Building Regulations where applicable.
- Position the fitting where desired and confirm the method of fixing which will be required: wood screw for wood, or wood screw/ wall plug for brick and masonry
- Carefully identify the location of the mains supply cable and any other cables in the area in which you intend to fix the lamp in order to avoid damage during installation.
- Carefully support the holder during the following wiring/ connection procedure.
- Using the connector block supplied, carefully connect your lamp to the housing wiring as detailed in the following diagram

Household supply

Neutral Loop - Blue or black

Earth Loop - Green/Yellow sleeved Copper

Switch Wires- Blue with Brown sheathing or
(Black with Red Sheathing)

Live Loop- Brown or (Red)

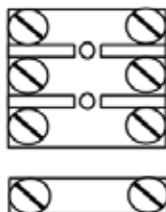

Light Fitting

Blue(N)

Green/Yellow

Brown

No connection
to light fitting

Electrical Installation - Continued

- Double check that all connections are tight. Ensure that the inner insulation is only stripped back sufficient to make a good contact in the terminal block.
- Carefully bind the terminal block and the cable either side with insulation tape (Not supplied) Ensuring that tape fully covers the cable to beyond the point where the outer insulation has been stripped.
- Install the mounting bracket using mounting screws (screws not provided, please refer to page 7)
- Screw the threaded rod from the ceiling rose to the mounting bracket and secure into place.

Assembly

These fittings are completely pre wired and only require a small amount of assembly after connection to the mains wiring as follows

Caution- Fragile item, extra care needed when installing

- Once the wall holder is installed, unscrew the screws from the holder
- Hold the glass shade into place
- Once in place begin to screw the screws back into the holder just enough to hold the shade, taking extra care not to screw to tightly into the glass. Once secure it will hold the shade in place, your Brooklyn pendant light is now installed.

SPECIFICATIONS

Category

We meet all UK and EU lighting and safety regulations.

Edison screw E27 lamp-holders are fitted as standard.

Shade reveals and protects the bulb

Dimensions include any shades supplied complete with fitting.

Please note: all our products are hand finished to ensure an authentic vintage look and therefore they may vary slightly from those shown in the images.

Finishes available:

Holder: Antique Brass , Dark Pewter , Copper

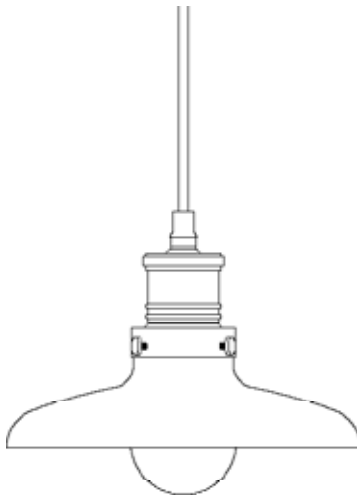

Dimensions:
Diameter: 22cm / 8.75"
Height: 19.5cm / 7"

PENDANTS - BROOKLYN VINTAGE ANTIQUE RIBBED GLASS RETRO FUNNEL

All of Industville designs are authentic and unique, having been inspired by the industrial and factory lighting of the late nineteenth and early twentieth century. Designed to reflect the true utilitarian function of this lighting style with classic lines and exposed hardware; they show the same attention to detail required for their original industrial purpose. At Industville, we endeavor to produce products that effectively combine good design and exceptional value without compromising quality. Perfect to bring vintage charm and the industrial look and feel into any interior space.

As with all our light fittings, Industville offers a huge range of sizes and options, including a variety of holders, finishes and up to 30 different fabric flex variations, in addition to a variety of energy efficient LED filament bulbs, to enable you to tailor your lighting choices to any style or size of project.

The strength of our company lies in the fact that our products are available in large numbers and offer the look and feel of vintage, retro industrial lighting without the cost and time-constraints of searching for originals. Nevertheless, as they are all hand finished by our skilled craftsmen in our dedicated factory, therefore all our products retain a unique and individual quality which remains true to the ethos and appeal of industrial lighting.

Electrical Installation

- Ensure the electrical supply is switched off
- Ensure that the electrical circuit to which this fitting is to be connected has been installed and fused in accordance with current IEE wiring regulations, BS7671.
- Products must also be installed in accordance with UK Building Regulations where applicable.
- Position the fitting where desired and confirm the method of fixing which will be required: wood screw for wood, or wood screw/ wall plug for brick and masonry
- Carefully identify the location of the mains supply cable and any other cables in the area in which you intend to fix the lamp in order to avoid damage during installation.
- Carefully support the holder during the following wiring/ connection procedure.
- Using the connector block supplied, carefully connect your lamp to the housing wiring as detailed in the following diagram

Household supply

Light Fitting

Neutral Loop - Blue or black

Earth Loop - Green/Yellow sleeved Copper

Switch Wires- Blue with Brown sheathing or
(Black with Red Sheathing)

Live Loop- Brown or (Red)

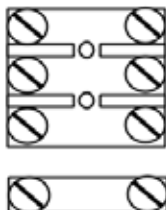

Blue(N)

Green/Yellow

Brown

No connection
to light fitting

Electrical Installation - Continued

- Double check that all connections are tight. Ensure that the inner insulation is only stripped back sufficient to make a good contact in the terminal block.
- Carefully bind the terminal block and the cable either side with insulation tape (Not supplied) Ensuring that tape fully covers the cable to beyond the point where the outer insulation has been stripped.
- Install the mounting bracket using mounting screws (screws not provided, please refer to page 7)
- Screw the threaded rod from the ceiling rose to the mounting bracket and secure into place.

Assembly

These fittings are completely pre wired and only require a small amount of assembly after connection to the mains wiring as follows:

Caution- Fragile item, extra care needed when installing

- Once the wall holder is installed, unscrew the screws from the holder
- Hold the glass shade into place
- Once in place begin to screw the screws back into the holder just enough to hold the shade, taking extra care not to screw to tightly into the glass. Once secure it will hold the shade to the holder, your Brooklyn pendant light is now installed.

SPECIFICATIONS

Category

We meet all UK and EU lighting and safety regulations.

Edison screw E27 lamp-holders are fitted as standard.

Shade reveals and protects the bulb

Dimensions include any shades supplied complete with fitting.

Please note: all our products are hand finished to ensure an authentic vintage look and therefore they may vary slightly from those shown in the images.

Finishes available:

Holder: Antique Brass, Dark Pewter, Copper

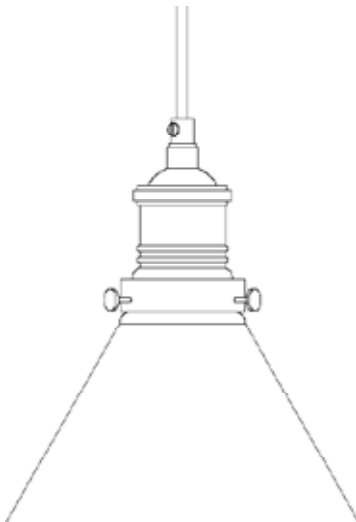

Dimensions:
Diameter: 17.5cm/ 7"
Height: 21.5cm/ 18.5"

PENDANTS -

BROOKLYN VINTAGE ANTIQUE RIBBED GLASS RETRO DOME PENDANT - 12 INCH

All of Industville designs are authentic and unique, having been inspired by the industrial and factory lighting of the late nineteenth and early twentieth century. Designed to reflect the true utilitarian function of this lighting style with classic lines and exposed hardware; they show the same attention to detail required for their original industrial purpose. At Industville, we endeavor to produce products that effectively combine good design and exceptional value without compromising quality. Perfect to bring vintage charm and the industrial look and feel into any interior space.

As with all our light fittings, Industville offers a huge range of sizes and options, including a variety of holders, finishes and up to 30 different fabric flex variations, in addition to a variety of energy efficient LED filament bulbs, to enable you to tailor your lighting choices to any style or size of project.

The strength of our company lies in the fact that our products are available in large numbers and offer the look and feel of vintage, retro industrial lighting without the cost and time-constraints of searching for originals. Nevertheless, as they are all hand finished by our skilled craftsmen in our dedicated factory, therefore all our products retain a unique and individual quality which remains true to the ethos and appeal of industrial lighting.

Electrical Installation

- Ensure the electrical supply is switched off
- Ensure that the electrical circuit to which this fitting is to be connected has been installed and fused in accordance with current IEE wiring regulations, BS7671.
- Products must also be installed in accordance with UK Building Regulations where applicable.
- Position the fitting where desired and confirm the method of fixing which will be required: wood screw for wood, or wood screw/ wall plug for brick and masonry
- Carefully identify the location of the mains supply cable and any other cables in the area in which you intend to fix the lamp in order to avoid damage during installation.
- Carefully support the holder during the following wiring/ connection procedure.
- Using the connector block supplied, carefully connect your lamp to the housing wiring as detailed in the following diagram

Household supply

Neutral Loop - Blue or black

Earth Loop - Green/Yellow sleeved Copper

Switch Wires- Blue with Brown sheathing or
(Black with Red Sheathing)

Live Loop- Brown or (Red)

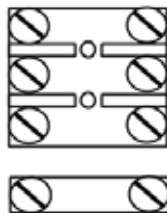

Light Fitting

Blue(N)

Green/Yellow

Brown

No connection
to light fitting

Electrical Installation - Continued

- Double check that all connections are tight. Ensure that the inner insulation is only stripped back sufficient to make a good contact in the terminal block.
- Carefully bind the terminal block and the cable either side with insulation tape (Not supplied) Ensuring that tape fully covers the cable to beyond the point where the outer insulation has been stripped.
- Install the mounting bracket using mounting screws (screws not provided, please refer to page 7)
- Screw the threaded rod from the ceiling rose to the mounting bracket and secure into place.

Assembly

These fitting are completely pre wired and only require a small amount of assembly after connection to the mains wiring as follows:

Caution- Fragile item, extra care needed when installing

- Once the wall holder is installed, unscrew the screws from the holder
- Hold the glass shade into place
- Once in place begin to screw the screws back into the holder just enough to hold the shade, taking extra care not to screw to tightly into the glass . Once secure it will hold the shade to the holder, your Brooklyn pendant is now installed.

SPECIFICATIONS

Category

We meet all UK and EU lighting and safety regulations.

Edison screw E27 lamp-holders are fitted as standard.

Shade reveals and protects the bulb

Dimensions include any shades supplied complete with fitting.

Please note: all our products are hand finished to ensure an authentic vintage look and therefore they may vary slightly from those shown in the images.

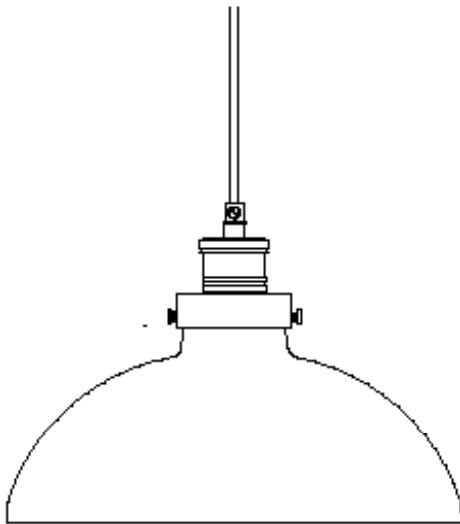

Dimensions:
Diameter: 32cm / 12"
Height: 17cm / 7"

PENDANT LIGHTS - BROOKLYN VINTAGE CONE - 12 INCH

All of Industville designs are authentic and unique, having been inspired by the industrial and factory lighting of the late nineteenth and early twentieth century. Designed to reflect the true utilitarian function of this lighting style with classic lines and exposed hardware; they show the same attention to detail required for their original industrial purpose. At Industville, we endeavor to produce products that effectively combine good design and exceptional value without compromising quality. Perfect to bring vintage charm and the industrial look and feel into any interior space.

As with all our light fittings, Industville offers a huge range of sizes and options, including a variety of holders, finishes and up to 30 different fabric flex variations, in addition to a variety of energy efficient LED filament bulbs, to enable you to tailor your lighting choices to any style or size of project.

The strength of our company lies in the fact that our products are available in large numbers and offer the look and feel of vintage, retro industrial lighting without the cost and time-constraints of searching for originals. Nevertheless, as they are all hand finished by our skilled craftsmen in our dedicated factory, therefore all our products retain a unique and individual quality which remains true to the ethos and appeal of industrial lighting.

Electrical Installation

- Ensure the electrical supply is switched off
- Ensure that the electrical circuit to which this fitting is to be connected has been installed and fused in accordance with current IEE wiring regulations, BS7671.
- Products must also be installed in accordance with UK Building Regulations where applicable.
- Position the fitting where desired and confirm the method of fixing which will be required: wood screw for wood, or wood screw/ wall plug for brick and masonry
- Carefully identify the location of the mains supply cable and any other cables in the area in which you intend to fix the lamp in order to avoid damage during installation.
- Carefully support the holder during the following wiring/ connection procedure.
- Using the connector block supplied, carefully connect your lamp to the housing wiring as detailed in the following diagram

Household supply

Neutral Loop - Blue or black

Earth Loop - Green/Yellow sleeved Copper

Switch Wires- Blue with Brown sheathing or
(Black with Red Sheathing)

Live Loop- Brown or (Red)

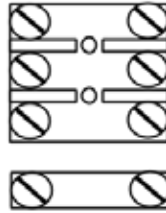

Light Fitting

Blue(N)

Green/Yellow

Brown

No connection
to light fitting

Electrical Installation - Continued

- Double check that all connections are tight. Ensure that the inner insulation is only stripped back sufficient to make a good contact in the terminal block.
- Carefully bind the terminal block and the cable either side with insulation tape (Not supplied) Ensuring that tape fully covers the cable to beyond the point where the outer insulation has been stripped.
- Install the mounting bracket using mounting screws (not provided, please refer to page 7)
- Screw the threaded rod from the ceiling rose to the mounting bracket and secure into place.

Assembly

These ceiling fitting are completely pre wired and only require a small amount of assembly after connection to the mains wiring as follows:

- Once the pendant holder is installed, unscrew the black ring (see page 6)
- Hold the shade in place onto the holder
- Once in place begin to screw the black ring.
- Once secure it will hold the shade to the holder, your Brooklyn Pendant is now installed.

SPECIFICATIONS

Category

We meet all UK and EU lighting and safety regulations.

Edison screw E27 lamp-holders are fitted as standard.

All pendants are supplied complete with fitting – this includes bulb holder, ceiling rose and 1M/39" of high quality black fabric flex (shade only option is available).

Dimensions include any shades supplied complete with fitting.

Please note: all our products are hand finished to ensure an authentic vintage look and therefore they may vary slightly from those shown in the images.

Finishes available:

Holder: Antique Brass, Dark Pewter, Copper

Shade: Dark Pewter, Antique Brass

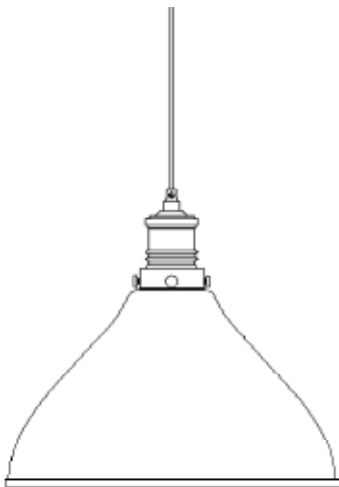

Dimensions:

Diameter: 30.5cm / 12"

Height: 32 cm / 13"

PENDANT LIGHTS - BROOKLYN VINTAGE DOME - 13 INCH

All of Industville designs are authentic and unique, having been inspired by the industrial and factory lighting of the late nineteenth and early twentieth century. Designed to reflect the true utilitarian function of this lighting style with classic lines and exposed hardware; they show the same attention to detail required for their original industrial purpose. At Industville, we endeavor to produce products that effectively combine good design and exceptional value without compromising quality. Perfect to bring vintage charm and the industrial look and feel into any interior space.

As with all our light fittings, Industville offers a huge range of sizes and options, including a variety of holders, finishes and up to 30 different fabric flex variations, in addition to a variety of energy efficient LED filament bulbs, to enable you to tailor your lighting choices to any style or size of project.

The strength of our company lies in the fact that our products are available in large numbers and offer the look and feel of vintage, retro industrial lighting without the cost and time-constraints of searching for originals. Nevertheless, as they are all hand finished by our skilled craftsmen in our dedicated factory, therefore all our products retain a unique and individual quality which remains true to the ethos and appeal of industrial lighting.

Electrical Installation

- Ensure the electrical supply is switched off
- Ensure that the electrical circuit to which this fitting is to be connected has been installed and fused in accordance with current IEE wiring regulations, BS7671.
- Products must also be installed in accordance with UK Building Regulations where applicable.
- Position the fitting where desired and confirm the method of fixing which will be required: wood screw for wood, or wood screw/ wall plug for brick and masonry
- Carefully identify the location of the mains supply cable and any other cables in the area in which you intend to fix the lamp in order to avoid damage during installation.
- Carefully support the holder during the following wiring/ connection procedure.
- Using the connector block supplied, carefully connect your lamp to the housing wiring as detailed in the following diagram

Household supply

Neutral Loop - Blue or black

Earth Loop - Green/Yellow sleeved Copper

Switch Wires- Blue with Brown sheathing or
(Black with Red Sheathing)

Live Loop- Brown or (Red)

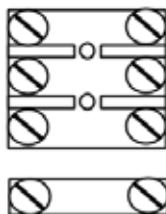

Light Fitting

Blue(N)

Green/Yellow

Brown

No connection
to light fitting

Electrical Installation - Continued

- Double check that all connections are tight. Ensure that the inner insulation is only stripped back sufficient to make a good contact in the terminal block.
- Carefully bind the terminal block and the cable either side with insulation tape (Not supplied) Ensuring that tape fully covers the cable to beyond the point where the outer insulation has been stripped.
- Install the mounting bracket using mounting screws (screws not provided, please refer to page 7)
- Screw the threaded rod from the ceiling rose to the mounting bracket and secure into place.

Assembly

These ceiling fitting are completely pre wired and only require a small amount of assembly after connection to the mains wiring as follows:

- Once the pendant holder is installed, unscrew the black ring (see page 6)
- Hold the shade in place onto the holder
- Once in place begin to screw the black ring. Once secure it will hold the shade to the holder, your Brooklyn Pendant is now installed.

SPECIFICATIONS

Category

We meet all UK and EU lighting and safety regulations.

Edison screw E27 lamp-holders are fitted as standard.

All pendants are supplied complete with fitting – this includes bulb holder, ceiling rose and 1M/39" of high quality black fabric flex (shade only option is available).

Dimensions include any shades supplied complete with fitting.

Please note: all our products are hand finished to ensure an authentic vintage look and therefore they may vary slightly from those shown in the images.

Finishes available:

Holder: Antique Brass, Dark Pewter, Copper

Shade: Dark Pewter, Antique Brass, Copper

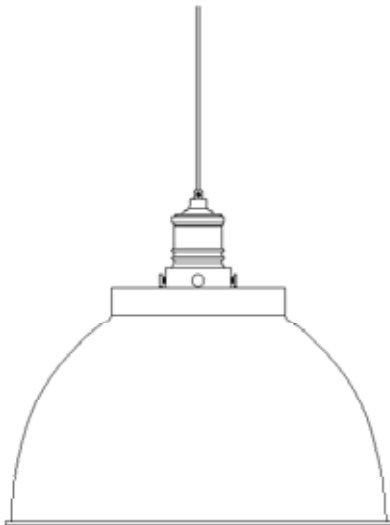

Dimensions:

Diameter: 33cm / 13"

Height: 35.5 cm / 14"

PENDANT LIGHTS - BROOKLYN VINTAGE GIANT BELL

All of Industville designs are authentic and unique, having been inspired by the industrial and factory lighting of the late nineteenth and early twentieth century. Designed to reflect the true utilitarian function of this lighting style with classic lines and exposed hardware; they show the same attention to detail required for their original industrial purpose. At Industville, we endeavor to produce products that effectively combine good design and exceptional value without compromising quality. Perfect to bring vintage charm and the industrial look and feel into any interior space.

As with all our light fittings, Industville offers a huge range of sizes and options, including a variety of holders, finishes and up to 30 different fabric flex variations, in addition to a variety of energy efficient LED filament bulbs, to enable you to tailor your lighting choices to any style or size of project. Our Pendants

The strength of our company lies in the fact that our products are available in large numbers and offer the look and feel of vintage, retro industrial lighting without the cost and time-constraints of searching for originals. Nevertheless, as they are all hand finished by our skilled craftsmen in our dedicated factory, therefore all our products retain a unique and individual quality which remains true to the ethos and appeal of industrial lighting.

Electrical Installation

- Ensure the electrical supply is switched off
- Ensure that the electrical circuit to which this fitting is to be connected has been installed and fused in accordance with current IEE wiring regulations, BS7671.
- Products must also be installed in accordance with UK Building Regulations where applicable.
- Position the fitting where desired and confirm the method of fixing which will be required: wood screw for wood, or wood screw/ wall plug for brick and masonry
- Carefully identify the location of the mains supply cable and any other cables in the area in which you intend to fix the lamp in order to avoid damage during installation.
- Carefully support the holder during the following wiring/ connection procedure.
- Using the connector block supplied, carefully connect your lamp to the housing wiring as detailed in the following diagram

Household supply

Light Fitting

Neutral Loop - Blue or black

Earth Loop - Green/Yellow sleeved Copper

Switch Wires- Blue with Brown sheathing or
(Black with Red Sheathing)

Live Loop- Brown or (Red)

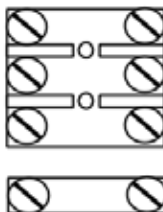

Blue(N)

Green/Yellow

Brown

No connection
to light fitting

Electrical Installation - Continued

- Double check that all connections are tight. Ensure that the inner insulation is only stripped back sufficient to make a good contact in the terminal block.
- Carefully bind the terminal block and the cable either side with insulation tape (Not supplied) Ensuring that tape fully covers the cable to beyond the point where the outer insulation has been stripped.
- Install the mounting bracket using mounting screws (screws not provided, please refer to page 7)
- Screw the threaded rod from the ceiling rose to the mounting bracket and secure into place.

Assembly

These ceiling fitting are completely pre wired and only require a small amount of assembly after connection to the mains wiring as follows:

- Once the pendant holder is installed, unscrew the black ring (see page 6)
- Hold the shade in place onto the holder
- Once in place begin to screw the black ring.
- Once secure it will hold the shade to the holder, your Brooklyn Pendant is now installed.

SPECIFICATIONS

Category

We meet all UK and EU lighting and safety regulations.

Edison screw E27 lamp-holders are fitted as standard.

All pendants are supplied complete with fitting – this includes bulb holder, ceiling rose and 1M/39" of high quality black fabric flex (shade only option is available).

Dimensions include any shades supplied complete with fitting.

Please note: all our products are hand finished to ensure an authentic vintage look and therefore they may vary slightly from those shown in the images.

Finishes available:

Holder: Antique Brass, Dark Pewter, Copper

Shade: Dark Pewter, Antique Brass

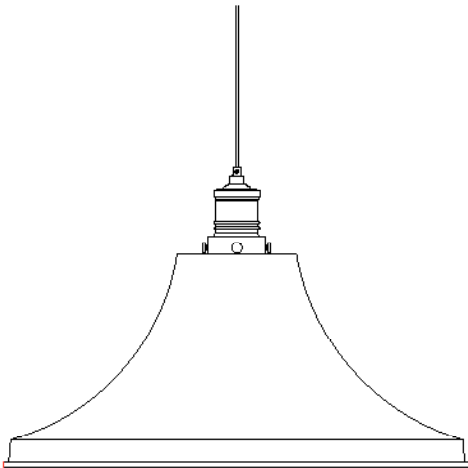

Dimensions:

Diameter: 50cm / 19.5"

Height: 40 cm / 15"

PENDANT LIGHTS - BROOKLYN VINTAGE GIANT HAT -

All of Industville designs are authentic and unique, having been inspired by the industrial and factory lighting of the late nineteenth and early twentieth century. Designed to reflect the true utilitarian function of this lighting style with classic lines and exposed hardware; they show the same attention to detail required for their original industrial purpose. At Industville, we endeavor to produce products that effectively combine good design and exceptional value without compromising quality. Perfect to bring vintage charm and the industrial look and feel into any interior space.

As with all our light fittings, Industville offers a huge range of sizes and options, including a variety of holders, finishes and up to 30 different fabric flex variations, in addition to a variety of energy efficient LED filament bulbs, to enable you to tailor your lighting choices to any style or size of project.

The strength of our company lies in the fact that our products are available in large numbers and offer the look and feel of vintage, retro industrial lighting without the cost and time-constraints of searching for originals. Nevertheless, as they are all hand finished by our skilled craftsmen in our dedicated factory, therefore all our products retain a unique and individual quality which remains true to the ethos and appeal of industrial lighting.

Electrical Installation

- Ensure the electrical supply is switched off
- Ensure that the electrical circuit to which this fitting is to be connected has been installed and fused in accordance with current IEE wiring regulations, BS7671.
- Products must also be installed in accordance with UK Building Regulations where applicable.
- Position the fitting where desired and confirm the method of fixing which will be required: wood screw for wood, or wood screw/ wall plug for brick and masonry
- Carefully identify the location of the mains supply cable and any other cables in the area in which you intend to fix the lamp in order to avoid damage during installation.
- Carefully support the holder during the following wiring/ connection procedure.
- Using the connector block supplied, carefully connect your lamp to the housing wiring as detailed in the following diagram

Household supply

Neutral Loop - Blue or black

Earth Loop - Green/Yellow sleeved Copper

Switch Wires- Blue with Brown sheathing or
(Black with Red Sheathing)

Live Loop- Brown or (Red)

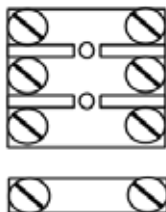

Light Fitting

Blue(N)

Green/Yellow

Brown

No connection
to light fitting

Electrical Installation - Continued

- Double check that all connections are tight. Ensure that the inner insulation is only stripped back sufficient to make a good contact in the terminal block.
- Carefully bind the terminal block and the cable either side with insulation tape (Not supplied) Ensuring that tape fully covers the cable to beyond the point where the outer insulation has been stripped.
- Install the mounting bracket using mounting screws (not provided, please refer to page 7)
- Screw the threaded rod from the ceiling rose to the mounting bracket and secure into place.

Assembly

These ceiling fitting are completely pre wired and only require a small amount of assembly after connection to the mains wiring as follows:

- Once the pendant holder is installed, unscrew the black ring (see page 6)
- Hold the shade in place onto the holder
- Once in place begin to screw the black ring.
- Once secure it will hold the shade to the holder, your Brooklyn Pendant is now installed.

SPECIFICATIONS

Category

We meet all UK and EU lighting and safety regulations.

Edison screw E27 lamp-holders are fitted as standard.

All pendants are supplied complete with fitting – this includes bulb holder, ceiling rose and 1M/39" of high quality black fabric flex (shade only option is available).

Dimensions include any shades supplied complete with fitting.

Please note: all our products are hand finished to ensure an authentic vintage look and therefore they may vary slightly from those shown in the images.

Finishes available:

Holder: Antique Brass, Dark Pewter, Copper

Shade: Dark Pewter, Antique Brass

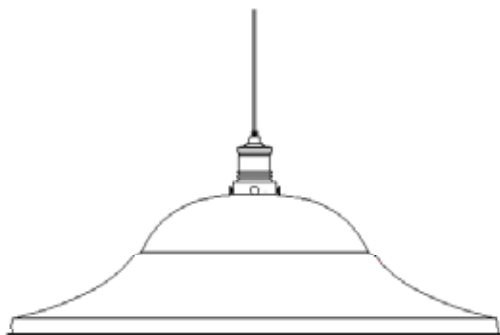

Dimensions:

Diameter: 52cm / 20.5"

Height: 38 cm / 15"

PENDANT LIGHTS - BROOKLYN VINTAGE STEP SHADE- 16 INCH

All of Industville designs are authentic and unique, having been inspired by the industrial and factory lighting of the late nineteenth and early twentieth century. Designed to reflect the true utilitarian function of this lighting style with classic lines and exposed hardware; they show the same attention to detail required for their original industrial purpose. At Industville, we endeavor to produce products that effectively combine good design and exceptional value without compromising quality. Perfect to bring vintage charm and the industrial look and feel into any interior space.

As with all our light fittings, Industville offers a huge range of sizes and options, including a variety of holders, finishes and up to 30 different fabric flex variations, in addition to a variety of energy efficient LED filament bulbs, to enable you to tailor your lighting choices to any style or size of project.

The strength of our company lies in the fact that our products are available in large numbers and offer the look and feel of vintage, retro industrial lighting without the cost and time-constraints of searching for originals. Nevertheless, as they are all hand finished by our skilled craftsmen in our dedicated factory, therefore all our products retain a unique and individual quality which remains true to the ethos and appeal of industrial lighting.

Electrical Installation

- Ensure the electrical supply is switched off
- Ensure that the electrical circuit to which this fitting is to be connected has been installed and fused in accordance with current IEE wiring regulations, BS7671.
- Products must also be installed in accordance with UK Building Regulations where applicable.
- Position the fitting where desired and confirm the method of fixing which will be required: wood screw for wood, or wood screw/ wall plug for brick and masonry
- Carefully identify the location of the mains supply cable and any other cables in the area in which you intend to fix the lamp in order to avoid damage during installation.
- Carefully support the holder during the following wiring/ connection procedure.
- Using the connector block supplied, carefully connect your lamp to the housing wiring as detailed in the following diagram

Household supply

Light Fitting

Neutral Loop - Blue or black

Earth Loop - Green/Yellow sleeved Copper

Switch Wires- Blue with Brown sheathing or
(Black with Red Sheathing)

Live Loop- Brown or (Red)

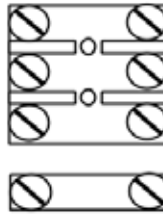

Blue(N)

Green/Yellow

Brown

No connection
to light fitting

Electrical Installation - Continued

- Double check that all connections are tight. Ensure that the inner insulation is only stripped back sufficient to make a good contact in the terminal block.
- Carefully bind the terminal block and the cable either side with insulation tape (Not supplied) Ensuring that tape fully covers the cable to beyond the point where the outer insulation has been stripped.
- Install the mounting bracket using mounting screws (not provided, please refer to page 7)
- Screw the threaded rod from the ceiling rose to the mounting bracket and secure into place.

Assembly

These ceiling fitting are completely pre wired and only require a small amount of assembly after connection to the mains wiring as follows:

- Once the pendant holder is installed, unscrew the black ring (see age 6)
- Hold the shade in place onto the holder
- Once in place begin to screw the black ring.
- Once secure it will hold the shade to the holder, your Brooklyn Pendant is now installed.

SPECIFICATIONS

Category

We meet all UK and EU lighting and safety regulations.

Edison screw E27 lamp-holders are fitted as standard.

All pendants are supplied complete with fitting – this includes bulb holder, ceiling rose and 1M/39" of high quality black fabric flex (shade only option is available).

Dimensions include any shades supplied complete with fitting.

Please note: all our products are hand finished to ensure an authentic vintage look and therefore they may vary slightly from those shown in the images.

Finishes available:

Holder: Antique Brass, Dark Pewter, Copper

Shade: Dark Pewter, Antique Brass

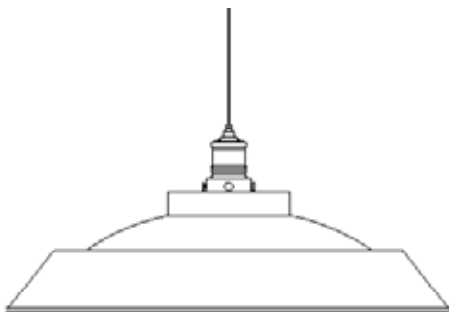

Dimensions:

Diameter: 41cm / 16"

Height: 30 cm / 12"

PENDANT LIGHTS - BROOKLYN VINTAGE GIANT STEP SHADE- 18 INCH

All of Industville designs are authentic and unique, having been inspired by the industrial and factory lighting of the late nineteenth and early twentieth century. Designed to reflect the true utilitarian function of this lighting style with classic lines and exposed hardware; they show the same attention to detail required for their original industrial purpose. At Industville, we endeavor to produce products that effectively combine good design and exceptional value without compromising quality. Perfect to bring vintage charm and the industrial look and feel into any interior space.

As with all our light fittings, Industville offers a huge range of sizes and options, including a variety of holders, finishes and up to 30 different fabric flex variations, in addition to a variety of energy efficient LED filament bulbs, to enable you to tailor your lighting choices to any style or size of project.

The strength of our company lies in the fact that our products are available in large numbers and offer the look and feel of vintage, retro industrial lighting without the cost and time-constraints of searching for originals. Nevertheless, as they are all hand finished by our skilled craftsmen in our dedicated factory, therefore all our products retain a unique and individual quality which remains true to the ethos and appeal of industrial lighting.

Electrical Installation

- Ensure the electrical supply is switched off
- Ensure that the electrical circuit to which this fitting is to be connected has been installed and fused in accordance with current IEE wiring regulations, BS7671.
- Products must also be installed in accordance with UK Building Regulations where applicable.
- Position the fitting where desired and confirm the method of fixing which will be required: wood screw for wood, or wood screw/ wall plug for brick and masonry
- Carefully identify the location of the mains supply cable and any other cables in the area in which you intend to fix the lamp in order to avoid damage during installation.
- Carefully support the holder during the following wiring/ connection procedure.
- Using the connector block supplied, carefully connect your lamp to the housing wiring as detailed in the following diagram

Household supply

Light Fitting

Neutral Loop - Blue or black

Earth Loop - Green/Yellow sleeved Copper

Switch Wires- Blue with Brown sheathing or
(Black with Red Sheathing)

Live Loop- Brown or (Red)

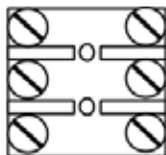

Blue(N)

Green/Yellow

Brown

No connection
to light fitting



Electrical Installation - Continued

- Double check that all connections are tight. Ensure that the inner insulation is only stripped back sufficient to make a good contact in the terminal block.
- Carefully bind the terminal block and the cable either side with insulation tape (Not supplied) Ensuring that tape fully covers the cable to beyond the point where the outer insulation has been stripped.
- Install the mounting bracket using mounting screws (not provided, please refer to page 7)
- Screw the threaded rod from the ceiling rose to the mounting bracket and secure into place.

Assembly

These ceiling fitting are completely pre wired and only require a small amount of assembly after connection to the mains wiring as follows:

- Once the pendant holder is installed, unscrew the black ring (see page 6)
- Hold the shade in place onto the holder
- Once in place begin to screw the black ring.
- Once secure it will hold the shade to the holder, your Brooklyn Pendant is now installed.

SPECIFICATIONS

Category

We meet all UK and EU lighting and safety regulations.

Edison screw E27 lamp-holders are fitted as standard.

All pendants are supplied complete with fitting – this includes bulb holder, ceiling rose and 1M/39" of high quality black fabric flex (shade only option is available).

Dimensions include any shades supplied complete with fitting.

Please note: all our products are hand finished to ensure an authentic vintage look and therefore they may vary slightly from those shown in the images.

Finishes available:

Holder: Antique Brass, Dark Pewter, Copper

Shade: Dark Pewter, Antique Brass

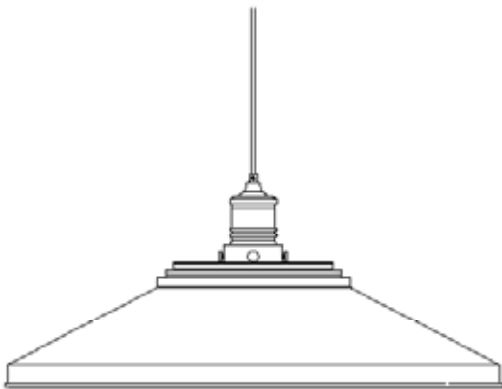

Dimensions:

Diameter: 47cm / 18.5"

Height: 25cm / 10"

PENDANT LIGHTS -

BROOKLYN VINTAGE METAL GIANT DOME PENDANT LIGHT - DARK PEWTER - 23.5 INCH

All of Industville designs are authentic and unique, having been inspired by the industrial and factory lighting of the late nineteenth and early twentieth century. Designed to reflect the true utilitarian function of this lighting style with classic lines and exposed hardware; they show the same attention to detail required for their original industrial purpose. At Industville, we endeavor to produce products that effectively combine good design and exceptional value without compromising quality. Perfect to bring vintage charm and the industrial look and feel into any interior space.

As with all our light fittings, Industville offers a huge range of sizes and options, including a variety of holders, finishes and up to 30 different fabric flex variations, in addition to a variety of energy efficient LED filament bulbs, to enable you to tailor your lighting choices to any style or size of project.

The strength of our company lies in the fact that our products are available in large numbers and offer the look and feel of vintage, retro industrial lighting without the cost and time-constraints of searching for originals. Nevertheless, as they are all hand finished by our skilled craftsmen in our dedicated factory, therefore all our products retain a unique and individual quality which remains true to the ethos and appeal of industrial lighting.

Electrical Installation

- Ensure the electrical supply is switched off
- Ensure that the electrical circuit to which this fitting is to be connected has been installed and fused in accordance with current IEE wiring regulations, BS7671.
- Products must also be installed in accordance with UK Building Regulations where applicable.
- Position the fitting where desired and confirm the method of fixing which will be required: wood screw for wood, or wood screw/ wall plug for brick and masonry
- Carefully identify the location of the mains supply cable and any other cables in the area in which you intend to fix the lamp in order to avoid damage during installation.
- Carefully support the holder during the following wiring/ connection procedure.
- Using the connector block supplied, carefully connect your lamp to the housing wiring as detailed in the following diagram

Household supply

Light Fitting

Neutral Loop - Blue or black

Earth Loop - Green/Yellow sleeved Copper

Switch Wires- Blue with Brown sheathing or
(Black with Red Sheathing)

Live Loop- Brown or (Red)

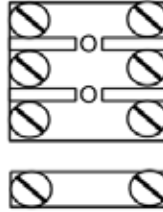

Blue(N)

Green/Yellow

Brown

No connection
to light fitting

Electrical Installation - Continued

- Double check that all connections are tight. Ensure that the inner insulation is only stripped back sufficient to make a good contact in the terminal block.
- Carefully bind the terminal block and the cable either side with insulation tape (Not supplied) Ensuring that tape fully covers the cable to beyond the point where the outer insulation has been stripped.
- Install the mounting bracket using mounting screws (not provided, please refer to page 7)
- Screw the threaded rod from the ceiling rose to the mounting bracket and secure into place.

Assembly

These ceiling fitting are completely pre-wired and only require a small amount of assembly after connection to the mains wiring as follows:

- Once the pendant holder is installed, unscrew the black ring
- Hold the shade in place onto the holder
- Once in place begin to screw the black ring. Once secure it will hold the shade to the holder, your Brooklyn Pendant is now installed.

SPECIFICATIONS

Category

We meet all UK and EU lighting and safety regulations.

Edison screw E27 lamp-holders are fitted as standard.

All pendants are supplied complete with fitting – this includes bulb holder, ceiling rose and 1M/39" of high quality black fabric flex (shade only option is available).

Dimensions include any shades supplied complete with fitting.

Please note: all our products are hand finished to ensure an authentic vintage look and therefore they may vary slightly from those shown in the images.

Finishes available: Dark Pewter

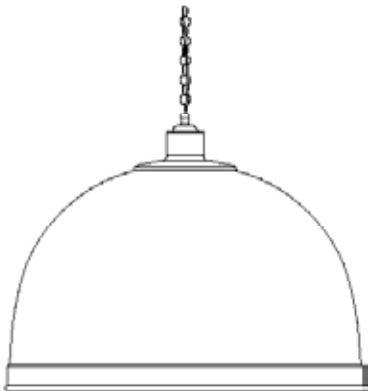

Dimensions:
Diameter: 60cm/23.5"
Height: 40.5cm/16"

PENDANT LIGHTS -

BROOKLYN VINTAGE GIANT BOWL METAL LAMPSHADE - DARK PEWTER - 24 INCH

All of Industville designs are authentic and unique, having been inspired by the industrial and factory lighting of the late nineteenth and early twentieth century. Designed to reflect the true utilitarian function of this lighting style with classic lines and exposed hardware; they show the same attention to detail required for their original industrial purpose. At Industville, we endeavor to produce products that effectively combine good design and exceptional value without compromising quality. Perfect to bring vintage charm and the industrial look and feel into any interior space.

As with all our light fittings, Industville offers a huge range of sizes and options, including a variety of holders, finishes and up to 30 different fabric flex variations, in addition to a variety of energy efficient LED filament bulbs, to enable you to tailor your lighting choices to any style or size of project.

The strength of our company lies in the fact that our products are available in large numbers and offer the look and feel of vintage, retro industrial lighting without the cost and time-constraints of searching for originals. Nevertheless, as they are all hand finished by our skilled craftsmen in our dedicated factory, therefore all our products retain a unique and individual quality which remains true to the ethos and appeal of industrial lighting.

Electrical Installation

- Ensure the electrical supply is switched off
- Ensure that the electrical circuit to which this fitting is to be connected has been installed and fused in accordance with current IEE wiring regulations, BS7671.
- Products must also be installed in accordance with UK Building Regulations where applicable.
- Position the fitting where desired and confirm the method of fixing which will be required: wood screw for wood, or wood screw/ wall plug for brick and masonry
- Carefully identify the location of the mains supply cable and any other cables in the area in which you intend to fix the lamp in order to avoid damage during installation.
- Carefully support the holder during the following wiring/ connection procedure.
- Using the connector block supplied, carefully connect your lamp to the housing wiring as detailed in the following diagram

Household supply

Light Fitting

Neutral Loop - Blue or black

Earth Loop - Green/Yellow sleeved Copper

Switch Wires- Blue with Brown sheathing or
(Black with Red Sheathing)

Live Loop- Brown or (Red)

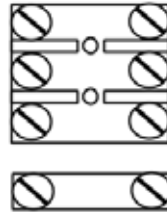

Blue(N)

Green/Yellow

Brown

No connection
to light fitting

Electrical Installation - Continued

- Double check that all connections are tight. Ensure that the inner insulation is only stripped back sufficient to make a good contact in the terminal block.
- Carefully bind the terminal block and the cable either side with insulation tape (not supplied) ensuring that tape fully covers the cable to beyond the point where the outer insulation has been stripped.
- Install the mounting bracket using mounting screws (not provided, please refer to page 7)
- Screw the threaded rod from the ceiling rose to the mounting bracket and secure into place.

Assembly

These ceiling fitting are completely pre-wired and only require a small amount of assembly after connection to the mains wiring as follows:

- Once the pendant holder is installed, unscrew the black ring
- Hold the shade in place onto the holder
- Once in place begin to screw the black ring. Once secure it will hold the shade to the holder, your Brooklyn Pendant is now installed.

SPECIFICATIONS

Category

We meet all UK and EU lighting and safety regulations.

Edison screw E27 lamp-holders are fitted as standard.

All pendants are supplied complete with fitting – this includes bulb holder, ceiling rose and 1M/39" of high quality black fabric flex (shade only option is available).

Dimensions include any shades supplied complete with fitting.

Please note: all our products are hand finished to ensure an authentic vintage look and therefore they may vary slightly from those shown in the images.

Finishes available:

Holder: Antique Brass, Dark Pewter, Copper

Shade: Dark Pewter

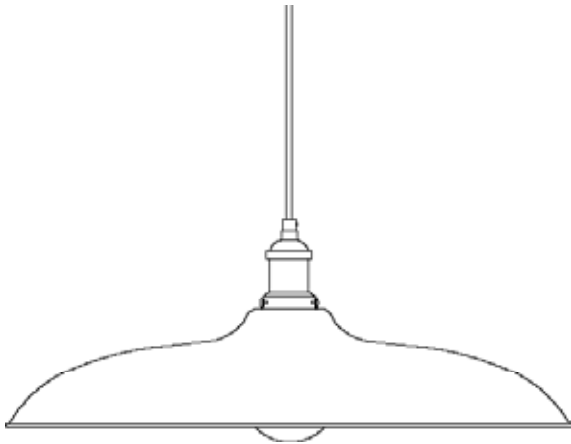

Dimensions:

Diameter: 60.5cm/24"

Height: 40.5cm/16"

PENDANT LIGHTS - ORLANDO VINTAGE CAGE

All of Industville designs are authentic and unique, having been inspired by the industrial and factory lighting of the late nineteenth and early twentieth century. Designed to reflect the true utilitarian function of this lighting style with classic lines and exposed hardware; they show the same attention to detail required for their original industrial purpose. At Industville, we endeavor to produce products that effectively combine good design and exceptional value without compromising quality. Perfect to bring vintage charm and the industrial look and feel into any interior space.

As with all our light fittings, Industville offers a huge range of sizes and options, including a variety of holders, finishes and up to 30 different fabric flex variations, in addition to a variety of energy efficient LED filament bulbs, to enable you to tailor your lighting choices to any style or size of project.

The strength of our company lies in the fact that our products are available in large numbers and offer the look and feel of vintage, retro industrial lighting without the cost and time-constraints of searching for originals. Nevertheless, as they are all hand finished by our skilled craftsmen in our dedicated factory, therefore all our products retain a unique and individual quality which remains true to the ethos and appeal of industrial lighting.

Electrical Installation

- Ensure the electrical supply is switched off
- Ensure that the electrical circuit to which this fitting is to be connected has been installed and fused in accordance with current IEE wiring regulations, BS7671.
- Products must also be installed in accordance with UK Building Regulations where applicable.
- Position the fitting where desired and confirm the method of fixing which will be required: wood screw for wood, or wood screw/ wall plug for brick and masonry
- Carefully identify the location of the mains supply cable and any other cables in the area in which you intend to fix the lamp in order to avoid damage during installation.
- Carefully support the holder during the following wiring/ connection procedure.
- Using the connector block supplied, carefully connect your lamp to the housing wiring as detailed in the following diagram

Household supply

Light Fitting

Neutral Loop - Blue or black

Earth Loop - Green/Yellow sleeved Copper

Switch Wires- Blue with Brown sheathing or
(Black with Red Sheathing)

Live Loop- Brown or (Red)

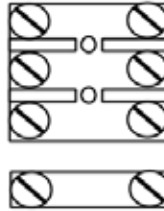

Blue(N)

Green/Yellow

Brown

No connection
to light fitting

Electrical Installation - Continued

- Double check that all connections are tight. Ensure that the inner insulation is only stripped back sufficient to make a good contact in the terminal block.
- Carefully bind the terminal block and the cable either side with insulation tape (Not supplied) Ensuring that tape fully covers the cable to beyond the point where the outer insulation has been stripped.
- Install the mounting bracket using mounting screws (not provided, please refer to page 7)
- Screw the threaded rod from the ceiling rose to the mounting bracket and secure into place.

Assembly

These ceiling fitting are completely pre-wired and only require a small amount of assembly after connection to the mains wiring as follows:

- Once the pendant holder is installed, unscrew the black ring attached to the holder (see page 6)
- Unscrew the small nut at the bottom of shade to open the cage
- Hold the cage in place and begin to screw the black ring
- Install the bulb and screw back the small nut.
- Once secure it will hold the shade to the holder, your Orlando Pendant is now installed.

SPECIFICATIONS

Category

We meet all UK and EU lighting and safety regulations.

Edison screw E27 lamp-holders are fitted as standard.

All pendants are supplied complete with fitting – this includes bulb holder, ceiling rose and 1M/39" of high quality black fabric flex (shade only option is available).

Dimensions include any shades supplied complete with fitting.

Please note: all our products are hand finished to ensure an authentic vintage look and therefore they may vary slightly from those shown in the images.

Finishes available: Antique Brass, Dark Pewter

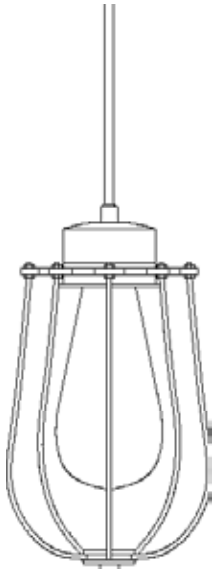

Dimensions:
Diameter: 13cm / 5"
Height: 22.5cm / 9"

PENDANT LIGHTS - ORLANDO CYLINDER WIRE CAGE

All of Industville designs are authentic and unique, having been inspired by the industrial and factory lighting of the late nineteenth and early twentieth century. Designed to reflect the true utilitarian function of this lighting style with classic lines and exposed hardware; they show the same attention to detail required for their original industrial purpose. At Industville, we endeavor to produce products that effectively combine good design and exceptional value without compromising quality. Perfect to bring vintage charm and the industrial look and feel into any interior space.

As with all our light fittings, Industville offers a huge range of sizes and options, including a variety of holders, finishes and up to 30 different fabric flex variations, in addition to a variety of energy efficient LED filament bulbs, to enable you to tailor your lighting choices to any style or size of project.

The strength of our company lies in the fact that our products are available in large numbers and offer the look and feel of vintage, retro industrial lighting without the cost and time-constraints of searching for originals. Nevertheless, as they are all hand finished by our skilled craftsmen in our dedicated factory, therefore all our products retain a unique and individual quality which remains true to the ethos and appeal of industrial lighting.

Electrical Installation

- Ensure the electrical supply is switched off
- Ensure that the electrical circuit to which this fitting is to be connected has been installed and fused in accordance with current IEE wiring regulations, BS7671.
- Products must also be installed in accordance with UK Building Regulations where applicable.
- Position the fitting where desired and confirm the method of fixing which will be required: wood screw for wood, or wood screw/ wall plug for brick and masonry
- Carefully identify the location of the mains supply cable and any other cables in the area in which you intend to fix the lamp in order to avoid damage during installation.
- Carefully support the holder during the following wiring/ connection procedure.
- Using the connector block supplied, carefully connect your lamp to the housing wiring as detailed in the following diagram

Household supply

Light Fitting

Neutral Loop - Blue or black

Earth Loop - Green/Yellow sleeved Copper

Switch Wires- Blue with Brown sheathing or
(Black with Red Sheathing)

Live Loop- Brown or (Red)

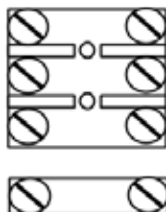

Blue(N)

Green/Yellow

Brown

No connection
to light fitting

Electrical Installation - Continued

- Double check that all connections are tight. Ensure that the inner insulation is only stripped back sufficient to make a good contact in the terminal block.
- Carefully bind the terminal block and the cable either side with insulation tape (not supplied) Ensuring that tape fully covers the cable to beyond the point where the outer insulation has been stripped.
- Install the mounting bracket using mounting screws (not provided, please refer to page 7)
- Screw the threaded rod from the ceiling rose to the mounting bracket and secure into place.

Assembly

These ceiling fitting are completely pre-wired and only require a small amount of assembly after connection to the mains wiring as follows:

- Once the pendant holder is installed, unscrew the black ring attached to the holder (see page 6)
- Unscrew the small nut at the bottom of shade to open the cage
- Hold the cage in place and begin to screw the black ring
- Install the bulb and screw back the small nut.
- Once secure it will hold the shade to the holder, your Orlando Pendant is now installed.

SPECIFICATIONS

Category

We meet all UK and EU lighting and safety regulations.

Edison screw E27 lamp-holders are fitted as standard.

All pendants are supplied complete with fitting – this includes bulb holder, ceiling rose and 1M/39" of high quality black fabric flex (shade only option is available).

Dimensions include any shades supplied complete with fitting.

Please note: all our products are hand finished to ensure an authentic vintage look and therefore they may vary slightly from those shown in the images.

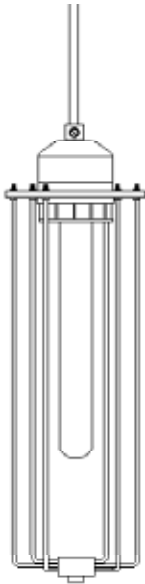

Dimensions:
Diameter: 9cm / 3.5"
Height: 30cm / 12"

PENDANT LIGHTS - ORLANDO VINTAGE BALLOON CAGE

All of Industville designs are authentic and unique, having been inspired by the industrial and factory lighting of the late nineteenth and early twentieth century. Designed to reflect the true utilitarian function of this lighting style with classic lines and exposed hardware; they show the same attention to detail required for their original industrial purpose. At Industville, we endeavor to produce products that effectively combine good design and exceptional value without compromising quality. Perfect to bring vintage charm and the industrial look and feel into any interior space.

As with all our light fittings, Industville offers a huge range of sizes and options, including a variety of holders, finishes and up to 30 different fabric flex variations, in addition to a variety of energy efficient LED filament bulbs, to enable you to tailor your lighting choices to any style or size of project.

The strength of our company lies in the fact that our products are available in large numbers and offer the look and feel of vintage, retro industrial lighting without the cost and time-constraints of searching for originals. Nevertheless, as they are all hand finished by our skilled craftsmen in our dedicated factory, therefore all our products retain a unique and individual quality which remains true to the ethos and appeal of industrial lighting.

Electrical Installation

- Ensure the electrical supply is switched off
- Ensure that the electrical circuit to which this fitting is to be connected has been installed and fused in accordance with current IEE wiring regulations, BS7671.
- Products must also be installed in accordance with UK Building Regulations where applicable.
- Position the fitting where desired and confirm the method of fixing which will be required: wood screw for wood, or wood screw/ wall plug for brick and masonry
- Carefully identify the location of the mains supply cable and any other cables in the area in which you intend to fix the lamp in order to avoid damage during installation.
- Carefully support the holder during the following wiring/ connection procedure.
- Using the connector block supplied, carefully connect your lamp to the housing wiring as detailed in the following diagram

Household supply

Neutral Loop - Blue or black

Earth Loop - Green/Yellow sleeved Copper

Switch Wires- Blue with Brown sheathing or
(Black with Red Sheathing)

Live Loop- Brown or (Red)

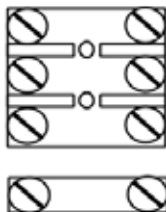

Light Fitting

Blue(N)

Green/Yellow

Brown

No connection
to light fitting

Electrical Installation - Continued

- Double check that all connections are tight. Ensure that the inner insulation is only stripped back sufficient to make a good contact in the terminal block.
- Carefully bind the terminal block and the cable either side with insulation tape (Not supplied) Ensuring that tape fully covers the cable to beyond the point where the outer insulation has been stripped.
- Install the mounting bracket using mounting screws (not provided, please refer to page 7)
- Screw the threaded rod from the ceiling rose to the mounting bracket and secure into place.

Assembly

These ceiling fitting are completely pre-wired and only require a small amount of assembly after connection to the mains wiring as follows:

- Once the pendant holder is installed, unscrew the small screws
- Install the bulb
- Old the cage shade in place onto the holder and begin to re screw the small screws
- Once secure it will hold the shade to the holder, your Orlando Pendant is now installed.

SPECIFICATIONS

Category

We meet all UK and EU lighting and safety regulations.

Edison screw E27 lamp-holders are fitted as standard.

All pendants are supplied complete with fitting – this includes bulb holder, ceiling rose and 1M/39" of high quality black fabric flex (shade only option is available).

Dimensions include any shades supplied complete with fitting.

Please note: all our products are hand finished to ensure an authentic vintage look and therefore they may vary slightly from those shown in the images.

Finishes available:

Holder: Antique Brass, Dark Pewter, Copper

Shade: Dark Pewter, Copper

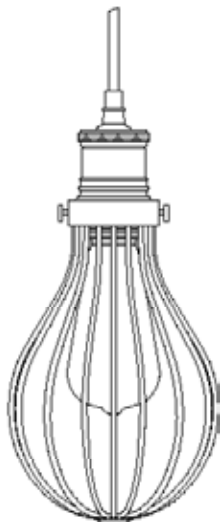

Dimensions:

Diameter: 13cm / 5"

Height: 29cm / 11.5"

PENDANT LIGHTS - OLD FACTORY PENDANT

All of Industville designs are authentic and unique, having been inspired by the industrial and factory lighting of the late nineteenth and early twentieth century. Designed to reflect the true utilitarian function of this lighting style with classic lines and exposed hardware; they show the same attention to detail required for their original industrial purpose. At Industville, we endeavor to produce products that effectively combine good design and exceptional value without compromising quality. Perfect to bring vintage charm and the industrial look and feel into any interior space.

As with all our light fittings, Industville offers a huge range of sizes and options, including a variety of holders, finishes and up to 30 different fabric flex variations, in addition to a variety of energy efficient LED filament bulbs, to enable you to tailor your lighting choices to any style or size of project.

The strength of our company lies in the fact that our products are available in large numbers and offer the look and feel of vintage, retro industrial lighting without the cost and time-constraints of searching for originals. Nevertheless, as they are all hand finished by our skilled craftsmen in our dedicated factory, therefore all our products retain a unique and individual quality which remains true to the ethos and appeal of industrial lighting.

Electrical Installation

- Ensure the electrical supply is switched off
- Ensure that the electrical circuit to which this fitting is to be connected has been installed and fused in accordance with current IEE wiring regulations, BS7671.
- Products must also be installed in accordance with UK Building Regulations where applicable.
- Position the fitting where desired and confirm the method of fixing which will be required: wood screw for wood, or wood screw/ wall plug for brick and masonry
- Carefully identify the location of the mains supply cable and any other cables in the area in which you intend to fix the lamp in order to avoid damage during installation.
- Carefully support the holder during the following wiring/ connection procedure.
- Using the connector block supplied, carefully connect your lamp to the housing wiring as detailed in the following diagram

Household supply

Neutral Loop - Blue or black

Earth Loop - Green/Yellow sleeved Copper

Switch Wires- Blue with Brown sheathing or
(Black with Red Sheathing)

Live Loop- Brown or (Red)

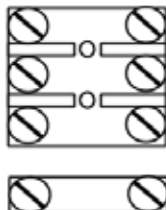

Light Fitting

Blue(N)

Green/Yellow

Brown

No connection
to light fitting

Electrical Installation - Continued

- Double check that all connections are tight. Ensure that the inner insulation is only stripped back sufficient to make a good contact in the terminal block.
- Carefully bind the terminal block and the cable either side with insulation tape (Not supplied) Ensuring that tape fully covers the cable to beyond the point where the outer insulation has been stripped.
- Install the mounting bracket using mounting screws (screws not provided, please refer to page 7)
- Screw the threaded rod from the ceiling rose to the mounting bracket and secure into place.

Assembly

These ceiling fitting are completely pre-wired and only require a small amount of assembly after connection to the mains wiring as follows:

- Once the pendant holder is installed, unscrew the metal silver ring
- Hold the shade in place onto the holder
- Once in place begin to screw the silver ring.
- Once secure it will hold the shade to the holder, your Old Factory Pendant is now installed.

SPECIFICATIONS

Category

We meet all UK and EU lighting and safety regulations.

Edison screw E27 lamp-holders are fitted as standard.

All pendants are supplied complete with fitting – this includes bulb holder, ceiling rose and 1M/39" of high quality black fabric flex (shade only option is available).

Dimensions include any shades supplied complete with fitting.

Please note: all our products are hand finished to ensure an authentic vintage look and therefore they may vary slightly from those shown in the images.

Finishes available:

Holder: Chrome

Shade: Antique Brass, Dark Pewter, Light Pewter, Copper

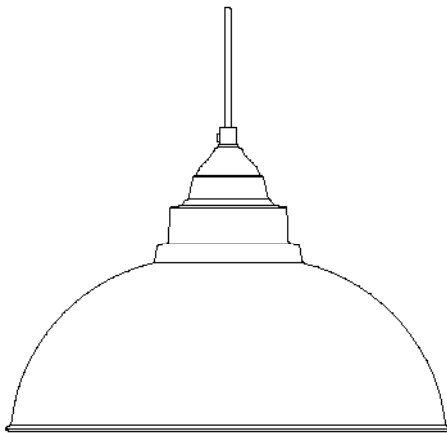

Dimensions:

Diameter: 31cm / 12"

Height: 31cm / 12"

PENDANT LIGHTS -

LARGE RETRO INDUSTRIAL - 17 INCH - 13INCH

All of Industville designs are authentic and unique, having been inspired by the industrial and factory lighting of the late nineteenth and early twentieth century. Designed to reflect the true utilitarian function of this lighting style with classic lines and exposed hardware; they show the same attention to detail required for their original industrial purpose. At Industville, we endeavor to produce products that effectively combine good design and exceptional value without compromising quality. Perfect to bring vintage charm and the industrial look and feel into any interior space.

As with all our light fittings, Industville offers a huge range of sizes and options, including a variety of holders, finishes and up to 30 different fabric flex variations, in addition to a variety of energy efficient LED filament bulbs, to enable you to tailor your lighting choices to any style or size of project.

The strength of our company lies in the fact that our products are available in large numbers and offer the look and feel of vintage, retro industrial lighting without the cost and time-constraints of searching for originals. Nevertheless, as they are all hand finished by our skilled craftsmen in our dedicated factory, therefore all our products retain a unique and individual quality which remains true to the ethos and appeal of industrial lighting.

Electrical Installation

- Ensure the electrical supply is switched off
- Ensure that the electrical circuit to which this fitting is to be connected has been installed and fused in accordance with current IEE wiring regulations, BS7671.
- Products must also be installed in accordance with UK Building Regulations where applicable.
- Position the fitting where desired and confirm the method of fixing which will be required: wood screw for wood, or wood screw/ wall plug for brick and masonry
- Carefully identify the location of the mains supply cable and any other cables in the area in which you intend to fix the lamp in order to avoid damage during installation.
- Carefully support the holder during the following wiring/ connection procedure.
- Using the connector block supplied, carefully connect your lamp to the housing wiring as detailed in the following diagram.

Household supply

Neutral Loop - Blue or black

Earth Loop - Green/Yellow sleeved Copper

Switch Wires- Blue with Brown sheathing or
(Black with Red Sheathing)

Live Loop- Brown or (Red)

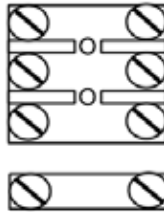

Light Fitting

Blue(N)

Green/Yellow

Brown

No connection
to light fitting

Electrical Installation - Continued

- Double check that all connections are tight. Ensure that the inner insulation is only stripped back sufficient to make a good contact in the terminal block.
- Carefully bind the terminal block and the cable either side with insulation tape (not supplied) Ensuring that tape fully covers the cable to beyond the point where the outer insulation has been stripped.
- Install the mounting bracket using mounting screws (screws not provided)
- Screw the threaded rod from the ceiling rose to the mounting bracket and secure into place.

Assembly

These ceiling fitting are completely pre-wired and only require a small amount of pre-assembly after connection to the mains wiring as follows:

- Thread the holder through the shade
- Holding the shade carefully, begin electrical installation (as above)
- Install the bulb, your pendant is now installed.

SPECIFICATIONS

Category

We meet all UK and EU lighting and safety regulations.

Edison screw E27 lamp-holders are fitted as standard.

All pendants are supplied complete with fitting – this includes bulb holder, ceiling rose and 1M/39" of high quality black fabric flex (shade only option is available).

Dimensions include any shades supplied complete with fitting.

Please note: all our products are hand finished to ensure an authentic vintage look and therefore they may vary slightly from those shown in the images.

Finishes available: Antique Brass, Dark Pewter

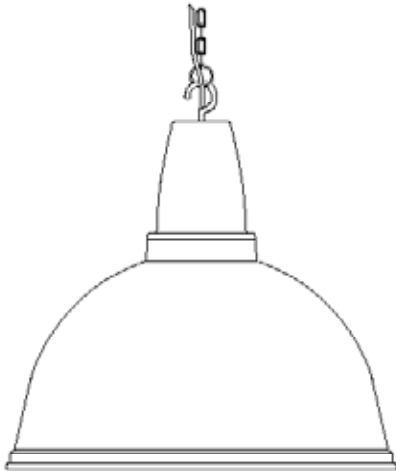

Dimensions:
Diameter: 42cm / 17"
Height: 46cm / 18"

PENDANT LIGHTS -

RETRO ENAMEL CAGE PENDANT LIGHT - 14 INCH

All of Industville designs are authentic and unique, having been inspired by the industrial and factory lighting of the late nineteenth and early twentieth century. Designed to reflect the true utilitarian function of this lighting style with classic lines and exposed hardware; they show the same attention to detail required for their original industrial purpose. At Industville, we endeavor to produce products that effectively combine good design and exceptional value without compromising quality. Perfect to bring vintage charm and the industrial look and feel into any interior space.

As with all our light fittings, Industville offers a huge range of sizes and options, including a variety of holders, finishes and up to 30 different fabric flex variations, in addition to a variety of energy efficient LED filament bulbs, to enable you to tailor your lighting choices to any style or size of project.

The strength of our company lies in the fact that our products are available in large numbers and offer the look and feel of vintage, retro industrial lighting without the cost and time-constraints of searching for originals. Nevertheless, as they are all hand finished by our skilled craftsmen in our dedicated factory, therefore all our products retain a unique and individual quality which remains true to the ethos and appeal of industrial lighting.

Electrical Installation

- Ensure the electrical supply is switched off
- Ensure that the electrical circuit to which this fitting is to be connected has been installed and fused in accordance with current IEE wiring regulations, BS7671.
- Products must also be installed in accordance with UK Building Regulations where applicable.
- Position the fitting where desired and confirm the method of fixing which will be required: wood screw for wood, or wood screw/ wall plug for brick and masonry
- Carefully identify the location of the mains supply cable and any other cables in the area in which you intend to fix the lamp in order to avoid damage during installation.
- Carefully support the holder during the following wiring/ connection procedure.
- Using the connector block supplied, carefully connect your lamp to the housing wiring as detailed in the following diagram

Household supply

Light Fitting

Neutral Loop - Blue or black

Earth Loop - Green/Yellow sleeved Copper

Switch Wires- Blue with Brown sheathing or
(Black with Red Sheathing)

Live Loop- Brown or (Red)

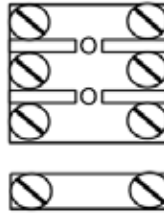

Blue(N)

Green/Yellow

Brown

No connection
to light fitting

Electrical Installation - Continued

- Double check that all connections are tight. Ensure that the inner insulation is only stripped back sufficient to make a good contact in the terminal block.
- Carefully bind the terminal block and the cable either side with insulation tape (not supplied) Ensuring that tape fully covers the cable to beyond the point where the outer insulation has been stripped.
- Install the mounting bracket using mounting screws (screws not provided, please refer to page 7)
- Screw the threaded rod from the ceiling rose to the mounting bracket and secure into place.

Assembly

These ceiling fitting are completely pre-wired and only require a small amount of assembly after connection to the mains wiring as follows:

- Once the pendant holder is installed, unscrew the bolts and nuts
- Hold the shade in place onto the holder lining up the holes
- Once in place begin to screw the bolts and nuts.
- Once secure it will hold the shade to the holder, your pendant is now installed.
- You can now install the bulb and attach the cage (optional).

SPECIFICATIONS

Category

We meet all UK and EU lighting and safety regulations.

Edison screw E27 lamp-holders are fitted as standard.

All pendants are supplied complete with fitting – this includes bulb holder, ceiling rose and 1M/39" of high quality black fabric flex (shade only option is available).

Dimensions include any shades supplied complete with fitting.

Please note: all our products are hand finished to ensure an authentic vintage look and therefore they may vary slightly from those shown in the images.

Finishes available:

Holder: Chrome

Shade: Dark Pewter, Grey, Brown, Orange

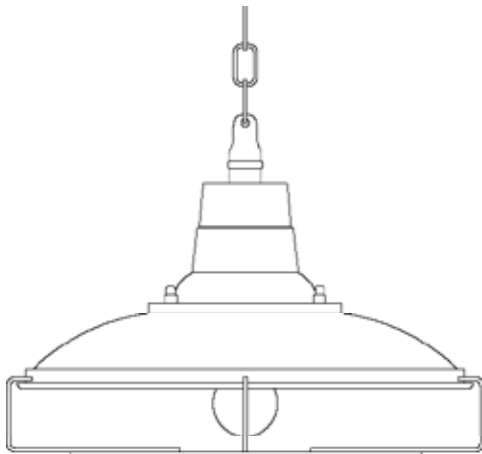

Dimensions:

Diameter: 35cm / 14"

Height: 35cm / 14"

PENDANT LIGHTS -

VINTAGE MOTORCYCLE FUNKY PENDANT

All of Industville designs are authentic and unique, having been inspired by the industrial and factory lighting of the late nineteenth and early twentieth century. Designed to reflect the true utilitarian function of this lighting style with classic lines and exposed hardware; they show the same attention to detail required for their original industrial purpose. At Industville, we endeavor to produce products that effectively combine good design and exceptional value without compromising quality. Perfect to bring vintage charm and the industrial look and feel into any interior space.

As with all our light fittings, Industville offers a huge range of sizes and options, including a variety of holders, finishes and up to 30 different fabric flex variations, in addition to a variety of energy efficient LED filament bulbs, to enable you to tailor your lighting choices to any style or size of project.

The strength of our company lies in the fact that our products are available in large numbers and offer the look and feel of vintage, retro industrial lighting without the cost and time-constraints of searching for originals. Nevertheless, as they are all hand finished by our skilled craftsmen in our dedicated factory, therefore all our products retain a unique and individual quality which remains true to the ethos and appeal of industrial lighting.

Electrical Installation

- Ensure the electrical supply is switched off
- Ensure that the electrical circuit to which this fitting is to be connected has been installed and fused in accordance with current IEE wiring regulations, BS7671.
- Products must also be installed in accordance with UK Building Regulations where applicable.
- Position the fitting where desired and confirm the method of fixing which will be required: wood screw for wood, or wood screw/ wall plug for brick and masonry
- Carefully identify the location of the mains supply cable and any other cables in the area in which you intend to fix the lamp in order to avoid damage during installation.
- Carefully support the holder during the following wiring/ connection procedure.
- Using the connector block supplied, carefully connect your lamp to the housing wiring as detailed in the following diagram

Household supply

Neutral Loop - Blue or black

Earth Loop - Green/Yellow sleeved Copper

Switch Wires- Blue with Brown sheathing or
(Black with Red Sheathing)

Live Loop- Brown or (Red)

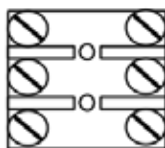

Light Fitting

Blue(N)

Green/Yellow

Brown

No connection
to light fitting

Electrical Installation - Continued

- Double check that all connections are tight. Ensure that the inner insulation is only stripped back sufficient to make a good contact in the terminal block.
- Carefully bind the terminal block and the cable either side with insulation tape (Not supplied) Ensuring that tape fully covers the cable to beyond the point where the outer insulation has been stripped.
- Install the mounting bracket using mounting screws (screws not provided, please refer to page 7)
- Screw the threaded rod from the ceiling rose to the mounting bracket and secure into place.

Assembly

These ceiling fittings are completely pre-wired and only require Installation of the bulb.

- Remove the glass cover by unscrewing the 2 screws either sides of the fitting
- Ensure that the power supply has been disconnected
- Screw in the bulb into place
- Hold the glass cover back into place
- Once in place begin to screw back the two side screws. Once secure your pendant light is now installed.

SPECIFICATIONS

Category

We meet all UK and EU lighting and safety regulations.

Edison screw E27 lamp-holders are fitted as standard.

All pendants are supplied complete with fitting – this includes bulb holder, ceiling rose and 1M/39" of high quality black fabric flex (shade only option is available).

Dimensions include any shades supplied complete with fitting.

Please note: all our products are hand finished to ensure an authentic vintage look and therefore they may vary slightly from those shown in the images.

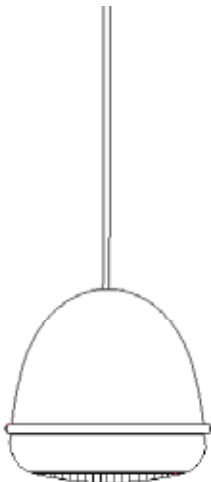

Dimensions:
Diameter: 17cm / 7"
Height: 20cm / 8"

PENDANT LIGHTS -

HANDCRAFTED UNIQUE VINTAGE CAGE WIRE METAL PENDANT LIGHT - DROP

All of Industville designs are authentic and unique, having been inspired by the industrial and factory lighting of the late nineteenth and early twentieth century. Designed to reflect the true utilitarian function of this lighting style with classic lines and exposed hardware; they show the same attention to detail required for their original industrial purpose. At Industville, we endeavor to produce products that effectively combine good design and exceptional value without compromising quality. Perfect to bring vintage charm and the industrial look and feel into any interior space.

As with all our light fittings, Industville offers a huge range of sizes and options, including a variety of holders, finishes and up to 30 different fabric flex variations, in addition to a variety of energy efficient LED filament bulbs, to enable you to tailor your lighting choices to any style or size of project.

The strength of our company lies in the fact that our products are available in large numbers and offer the look and feel of vintage, retro industrial lighting without the cost and time-constraints of searching for originals. Nevertheless, as they are all hand finished by our skilled craftsmen in our dedicated factory, therefore all our products retain a unique and individual quality which remains true to the ethos and appeal of industrial lighting.

Electrical Installation

- Ensure the electrical supply is switched off
- Ensure that the electrical circuit to which this fitting is to be connected has been installed and fused in accordance with current IEE wiring regulations, BS7671.
- Products must also be installed in accordance with UK Building Regulations where applicable.
- Position the fitting where desired and confirm the method of fixing which will be required: wood screw for wood, or wood screw/ wall plug for brick and masonry
- Carefully identify the location of the mains supply cable and any other cables in the area in which you intend to fix the lamp in order to avoid damage during installation.
- Carefully support the holder during the following wiring/ connection procedure.
- Using the connector block supplied, carefully connect your lamp to the housing wiring as detailed in the following diagram

Household supply

Neutral Loop - Blue or black

Earth Loop - Green/Yellow sleeved Copper

Switch Wires- Blue with Brown sheathing or
(Black with Red Sheathing)

Live Loop- Brown or (Red)

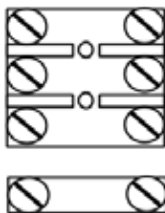

Light Fitting

Blue(N)

Green/Yellow

Brown

No connection
to light fitting

Electrical Installation - Continued

- Double check that all connections are tight. Ensure that the inner insulation is only stripped back sufficient to make a good contact in the terminal block.
- Carefully bind the terminal block and the cable either side with insulation tape (not supplied) ensuring that tape fully covers the cable to beyond the point where the outer insulation has been stripped.
- Install the mounting bracket using mounting screws (screws not provided, please refer to page 7)
- Screw the threaded rod from the ceiling rose to the mounting bracket and secure into place.

Assembly

These ceiling fitting are completely pre-wired and only require a small amount of assembly after connection to the mains wiring as follows:

- Once the pendant holder is installed, unscrew the metal silver ring
- Hold the shade in place onto the holder
- Once in place begin to screw the silver ring.
- Once secure it will hold the shade to the holder, your Brooklyn Pendant is now installed.

SPECIFICATIONS

Category

We meet all UK and EU lighting and safety regulations.

Edison screw E27 lamp-holders are fitted as standard.

All pendants are supplied complete with fitting – this includes bulb holder, ceiling rose and 1M/39" of high quality black fabric flex (shade only option is available).

Dimensions include any shades supplied complete with fitting.

Please note: all our products are hand finished to ensure an authentic vintage look and therefore they may vary slightly from those shown in the images.

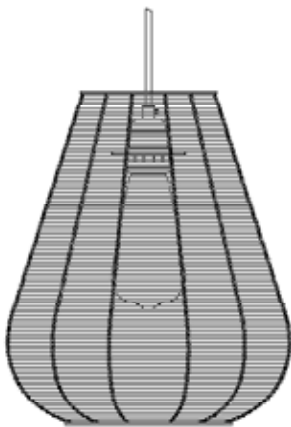

Dimensions:
Diameter: 23cm/ 9"
Height: 27cm/11"

PENDANT LIGHTS -

HANDCRAFTED UNIQUE VINTAGE CAGE WIRE METAL PENDANT LIGHT - ROUND

All of Industville designs are authentic and unique, having been inspired by the industrial and factory lighting of the late nineteenth and early twentieth century. Designed to reflect the true utilitarian function of this lighting style with classic lines and exposed hardware; they show the same attention to detail required for their original industrial purpose. At Industville, we endeavor to produce products that effectively combine good design and exceptional value without compromising quality. Perfect to bring vintage charm and the industrial look and feel into any interior space.

As with all our light fittings, Industville offers a huge range of sizes and options, including a variety of holders, finishes and up to 30 different fabric flex variations, in addition to a variety of energy efficient LED filament bulbs, to enable you to tailor your lighting choices to any style or size of project.

The strength of our company lies in the fact that our products are available in large numbers and offer the look and feel of vintage, retro industrial lighting without the cost and time-constraints of searching for originals. Nevertheless, as they are all hand finished by our skilled craftsmen in our dedicated factory, therefore all our products retain a unique and individual quality which remains true to the ethos and appeal of industrial lighting.

Electrical Installation

- Ensure the electrical supply is switched off
- Ensure that the electrical circuit to which this fitting is to be connected has been installed and fused in accordance with current IEE wiring regulations, BS7671.
- Products must also be installed in accordance with UK Building Regulations where applicable.
- Position the fitting where desired and confirm the method of fixing which will be required: wood screw for wood, or wood screw/ wall plug for brick and masonry
- Carefully identify the location of the mains supply cable and any other cables in the area in which you intend to fix the lamp in order to avoid damage during installation.
- Carefully support the holder during the following wiring/ connection procedure.
- Using the connector block supplied, carefully connect your lamp to the housing wiring as detailed in the following diagram

Household supply

Light Fitting

Neutral Loop - Blue or black

Earth Loop - Green/Yellow sleeved Copper

Switch Wires- Blue with Brown sheathing or
(Black with Red Sheathing)

Live Loop- Brown or (Red)

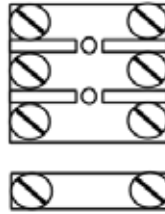

Blue(N)

Green/Yellow

Brown

No connection
to light fitting

Electrical Installation - Continued

- Double check that all connections are tight. Ensure that the inner insulation is only stripped back sufficient to make a good contact in the terminal block.
- Carefully bind the terminal block and the cable either side with insulation tape (not supplied) ensuring that tape fully covers the cable to beyond the point where the outer insulation has been stripped.
- Install the mounting bracket using mounting screws (screws not provided, please refer to page 7)
- Screw the threaded rod from the ceiling rose to the mounting bracket and secure into place.

Assembly

These ceiling fitting are completely pre-wired and only require a small amount of assembly after connection to the mains wiring as follows:

- Once the pendant holder is installed, unscrew the metal silver ring
- Hold the shade in place onto the holder
- Once in place begin to screw the silver ring.
- Once secure it will hold the shade to the holder, your Brooklyn Pendant is now installed.

SPECIFICATIONS

Category

We meet all UK and EU lighting and safety regulations.

Edison screw E27 lamp-holders are fitted as standard.

All pendants are supplied complete with fitting – this includes bulb holder, ceiling rose and 1M/39" of high quality black fabric flex (shade only option is available).

Dimensions include any shades supplied complete with fitting.

Please note: all our products are hand finished to ensure an authentic vintage look and therefore they may vary slightly from those shown in the images.

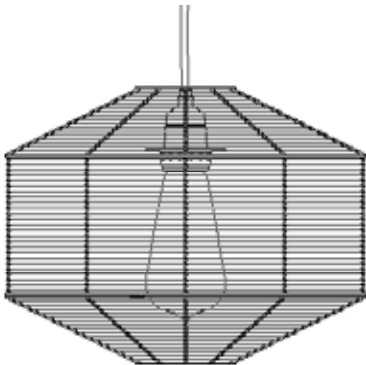

Dimensions:
Diameter: 30cm/ 12"
Height: 23cm/9"

PENDANT LIGHTS -

HANDCRAFTED UNIQUE VINTAGE CAGE WIRE METAL PENDANT LIGHT - CONE

All of Industville designs are authentic and unique, having been inspired by the industrial and factory lighting of the late nineteenth and early twentieth century. Designed to reflect the true utilitarian function of this lighting style with classic lines and exposed hardware; they show the same attention to detail required for their original industrial purpose. At Industville, we endeavor to produce products that effectively combine good design and exceptional value without compromising quality. Perfect to bring vintage charm and the industrial look and feel into any interior space.

As with all our light fittings, Industville offers a huge range of sizes and options, including a variety of holders, finishes and up to 30 different fabric flex variations, in addition to a variety of energy efficient LED filament bulbs, to enable you to tailor your lighting choices to any style or size of project.

The strength of our company lies in the fact that our products are available in large numbers and offer the look and feel of vintage, retro industrial lighting without the cost and time-constraints of searching for originals. Nevertheless, as they are all hand finished by our skilled craftsmen in our dedicated factory, therefore all our products retain a unique and individual quality which remains true to the ethos and appeal of industrial lighting.

Electrical Installation

- Ensure the electrical supply is switched off
- Ensure that the electrical circuit to which this fitting is to be connected has been installed and fused in accordance with current IEE wiring regulations, BS7671.
- Products must also be installed in accordance with UK Building Regulations where applicable.
- Position the fitting where desired and confirm the method of fixing which will be required: wood screw for wood, or wood screw/ wall plug for brick and masonry
- Carefully identify the location of the mains supply cable and any other cables in the area in which you intend to fix the lamp in order to avoid damage during installation.
- Carefully support the holder during the following wiring/ connection procedure.
- Using the connector block supplied, carefully connect your lamp to the housing wiring as detailed in the following diagram

Household supply

Light Fitting

Neutral Loop - Blue or black

Earth Loop - Green/Yellow sleeved Copper

Switch Wires- Blue with Brown sheathing or
(Black with Red Sheathing)

Live Loop- Brown or (Red)

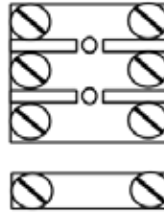

Blue(N)

Green/Yellow

Brown

No connection
to light fitting

Electrical Installation - Continued

- Double check that all connections are tight. Ensure that the inner insulation is only stripped back sufficient to make a good contact in the terminal block.
- Carefully bind the terminal block and the cable either side with insulation tape (not supplied) ensuring that tape fully covers the cable to beyond the point where the outer insulation has been stripped.
- Install the mounting bracket using mounting screws (screws not provided, please refer to page 7)
- Screw the threaded rod from the ceiling rose to the mounting bracket and secure into place.

Assembly

These ceiling fitting are completely pre-wired and only require a small amount of assembly after connection to the mains wiring as follows:

- Once the pendant holder is installed, unscrew the black ring
- Hold the shade in place onto the holder
- Once in place begin to screw the black ring. Once secure it will hold the shade to the holder, your Brooklyn Pendant is now installed.

SPECIFICATIONS

Category

We meet all UK and EU lighting and safety regulations.

Edison screw E27 lamp-holders are fitted as standard.

All pendants are supplied complete with fitting – this includes bulb holder, ceiling rose and 1M/39" of high quality black fabric flex (shade only option is available).

Dimensions include any shades supplied complete with fitting.

Please note: all our products are hand finished to ensure an authentic vintage look and therefore they may vary slightly from those shown in the images.

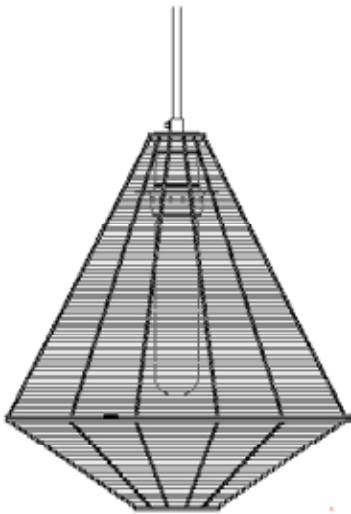

Dimensions:
Diameter: 21.5cm/ 8.5"
Height: 27cm/ 11"

WALL LIGHTS - BROOKLYN VINTAGE ANTIQUE SCONCE - FLAT

All of Industville designs are authentic and unique, having been inspired by the industrial and factory lighting of the late nineteenth and early twentieth century. Designed to reflect the true utilitarian function of this lighting style with classic lines and exposed hardware; they show the same attention to detail required for their original industrial purpose. At Industville, we endeavour to produce products that effectively combine good design and exceptional value without compromising quality. Perfect to bring vintage charm and the industrial look and feel into any interior space.

Industville offers a huge range of sizes and options, including a variety of holders and finishes in addition to a variety of energy efficient LED filament bulbs, to enable you to tailor your lighting choices to any style or size of project.

The strength of our company lies in the fact that our products are available in large numbers and offer the look and feel of vintage, retro industrial lighting without the cost and time-constraints of searching for originals. Nevertheless, as they are all hand finished by our skilled craftsmen in our dedicated factory, therefore all our products retain a unique and individual quality which remains true to the ethos and appeal of industrial lighting

Electrical Installation

- Ensure the electrical supply is switched off
- Ensure that the electrical circuit to which this fitting is to be connected has been installed and fused in accordance with current IEE wiring regulations, BS7671.
- Products must also be installed in accordance with UK Building Regulations where applicable.
- Position the fitting where desired and confirm the method of fixing which will be required: wood screw for wood, or wood screw/ wall plug for brick and masonry
- Carefully identify the location of the mains supply cable and any other cables in the area in which you intend to fix the lamp in order to avoid damage during installation.
- Carefully support the holder during the following wiring/ connection procedure.
- Using the connector block supplied, carefully connect your lamp to the housing wiring as detailed in the following diagram

Household supply

Light Fitting

Neutral Loop - Blue or black

Earth Loop - Green/Yellow sleeved Copper

Switch Wires- Blue with Brown sheathing or
(Black with Red Sheathing)

Live Loop- Brown or (Red)

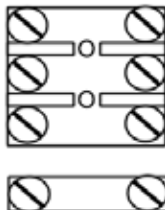

Blue(N)

Green/Yellow

Brown

No connection
to light fitting

Electrical Installation - Continued

- Double check that all connections are tight. Ensure that the inner insulation is only stripped back sufficient to make a good contact in the terminal block.
- Carefully bind the terminal block and the cable either side with insulation tape (not supplied) ensuring that tape fully covers the cable to beyond the point where the outer insulation has been stripped.
- Install the mounting bracket using mounting screws (screws not provided, please refer to page 7)
- Screw the threaded rod from the ceiling rose to the mounting bracket and secure into place.

Assembly

These wall fitting are completely pre wired and only require a small amount of assembly after connection to the mains wiring as follows:

- Once the wall holder is installed, unscrew the black ring (see page 6)
- Hold the shade in place onto the holder
- Once in place begin to screw the black ring.
- Once secure it will hold the shade to the holder, your Brooklyn wall sconce now installed.

SPECIFICATIONS

Category

We meet all UK and EU lighting and safety regulations.

Edison screw E27 lamp-holders are fitted as standard.

Shade reveals and protects the bulb

Dimensions include any shades supplied complete with fitting.

Please note: all our products are hand finished to ensure an authentic vintage look and therefore they may vary slightly from those shown in the images.

Finishes available: Antique Brass , Dark Pewter , Copper

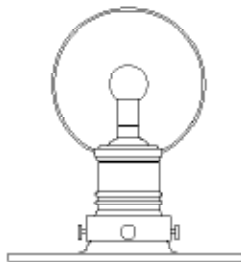
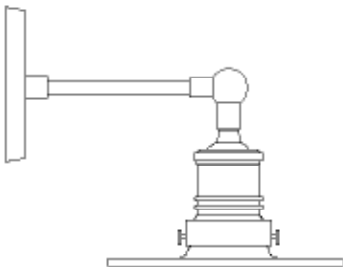

Dimensions:
Diameter: 21cm / 8"
Height: 22cm / 9"

WALL LIGHTS - BROOKLYN VINTAGE ANTIQUE SCONCE - UMBRELLA

All of Industville designs are authentic and unique, having been inspired by the industrial and factory lighting of the late nineteenth and early twentieth century. Designed to reflect the true utilitarian function of this lighting style with classic lines and exposed hardware; they show the same attention to detail required for their original industrial purpose. At Industville, we endeavour to produce products that effectively combine good design and exceptional value without compromising quality. Perfect to bring vintage charm and the industrial look and feel into any interior space.

Industville offers a huge range of sizes and options, including a variety of holders and finishes in addition to a variety of energy efficient LED filament bulbs, to enable you to tailor your lighting choices to any style or size of project.

The strength of our company lies in the fact that our products are available in large numbers and offer the look and feel of vintage, retro industrial lighting without the cost and time-constraints of searching for originals. Nevertheless, as they are all hand finished by our skilled craftsmen in our dedicated factory, therefore all our products retain a unique and individual quality which remains true to the ethos and appeal of industrial lighting

Electrical Installation

- Ensure the electrical supply is switched off
- Ensure that the electrical circuit to which this fitting is to be connected has been installed and fused in accordance with current IEE wiring regulations, BS7671.
- Products must also be installed in accordance with UK Building Regulations where applicable.
- Position the fitting where desired and confirm the method of fixing which will be required: wood screw for wood, or wood screw/ wall plug for brick and masonry
- Carefully identify the location of the mains supply cable and any other cables in the area in which you intend to fix the lamp in order to avoid damage during installation.
- Carefully support the holder during the following wiring/ connection procedure.
- Using the connector block supplied, carefully connect your lamp to the housing wiring as detailed in the following diagram

Household supply

Light Fitting

Neutral Loop - Blue or black

Earth Loop - Green/Yellow sleeved Copper

Switch Wires- Blue with Brown sheathing or
(Black with Red Sheathing)

Live Loop- Brown or (Red)

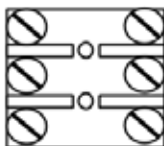

Blue (N)

Green/Yellow

Brown

No connection
to light fitting



Electrical Installation - Continued

- Double check that all connections are tight. Ensure that the inner insulation is only stripped back sufficient to make a good contact in the terminal block.
- Carefully bind the terminal block and the cable either side with insulation tape (not supplied) ensuring that tape fully covers the cable to beyond the point where the outer insulation has been stripped.
- Install the mounting bracket using mounting screws (not provided, please refer to page 7)
- Screw the threaded rod from the ceiling rose to the mounting bracket and secure into place.

Assembly

These wall fitting are completely pre wired and only require a small amount of assembly after connection to the mains wiring as follows:

- Once the wall holder is installed, unscrew the black ring
- Hold the shade in place onto the holder
- Once in place begin to screw the black ring. Once secure it will hold the shade to the holder, your Brooklyn wall sconce now installed.

SPECIFICATIONS

Category

We meet all UK and EU lighting and safety regulations.

Edison screw E27 lamp-holders are fitted as standard.

Shade reveals and protects the bulb

Dimensions include any shades supplied complete with fitting.

Please note: all our products are hand finished to ensure an authentic vintage look and therefore they may vary slightly from those shown in the images.

Finishes available:

Holder: Antique Brass , Dark Pewter , Copper

Shade: Antique Brass , Dark Pewter

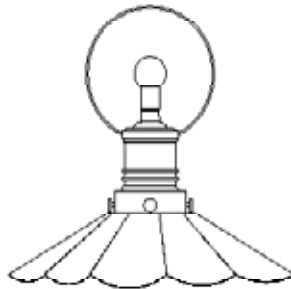
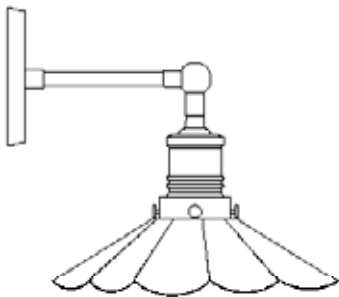

Dimensions:

Diameter: 12cm / 5"

Height: 24cm / 9.5"

WALL LIGHTS - BROOKLYN VINTAGE ANTIQUE SCONCE - CONE

All of Industville designs are authentic and unique, having been inspired by the industrial and factory lighting of the late nineteenth and early twentieth century. Designed to reflect the true utilitarian function of this lighting style with classic lines and exposed hardware; they show the same attention to detail required for their original industrial purpose. At Industville, we endeavour to produce products that effectively combine good design and exceptional value without compromising quality. Perfect to bring vintage charm and the industrial look and feel into any interior space.

Industville offers a huge range of sizes and options, including a variety of holders and finishes in addition to a variety of energy efficient LED filament bulbs, to enable you to tailor your lighting choices to any style or size of project.

The strength of our company lies in the fact that our products are available in large numbers and offer the look and feel of vintage, retro industrial lighting without the cost and time-constraints of searching for originals. Nevertheless, as they are all hand finished by our skilled craftsmen in our dedicated factory, therefore all our products retain a unique and individual quality which remains true to the ethos and appeal of industrial lighting

Electrical Installation

- Ensure the electrical supply is switched off
- Ensure that the electrical circuit to which this fitting is to be connected has been installed and fused in accordance with current IEE wiring regulations, BS7671.
- Products must also be installed in accordance with UK Building Regulations where applicable.
- Position the fitting where desired and confirm the method of fixing which will be required: wood screw for wood, or wood screw/ wall plug for brick and masonry
- Carefully identify the location of the mains supply cable and any other cables in the area in which you intend to fix the lamp in order to avoid damage during installation.
- Carefully support the holder during the following wiring/ connection procedure.
- Using the connector block supplied, carefully connect your lamp to the housing wiring as detailed in the following diagram

Household supply

Light Fitting

Neutral Loop - Blue or black

Earth Loop - Green/Yellow sleeved Copper

Switch Wires- Blue with Brown sheathing or
(Black with Red Sheathing)

Live Loop- Brown or (Red)

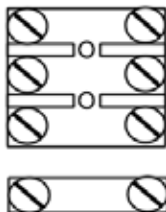

Blue(N)

Green/Yellow

Brown

No connection
to light fitting

Electrical Installation - Continued

- Double check that all connections are tight. Ensure that the inner insulation is only stripped back sufficient to make a good contact in the terminal block.
- Carefully bind the terminal block and the cable either side with insulation tape (not supplied) ensuring that tape fully covers the cable to beyond the point where the outer insulation has been stripped.
- Install the mounting bracket using mounting screws (not provided, please refer to page 7)
- Screw the threaded rod from the ceiling rose to the mounting bracket and secure into place.

Assembly

These wall fitting are completely pre wired and only require a small amount of assembly after connection to the mains wiring as follows:

- Once the wall holder is installed, unscrew the black ring
- Hold the shade in place onto the holder
- Once in place begin to screw the black ring.
- Once secure it will hold the shade to the holder, your Brooklyn wall sconce now installed.

SPECIFICATIONS

Category

We meet all UK and EU lighting and safety regulations.

Edison screw E27 lamp-holders are fitted as standard.

Shade reveals and protects the bulb

Dimensions include any shades supplied complete with fitting.

Please note: all our products are hand finished to ensure an authentic vintage look and therefore they may vary slightly from those shown in the images.

Finishes available: Antique Brass, Dark Pewter, Copper

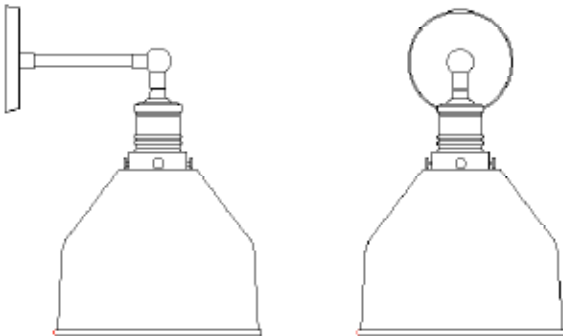

Dimensions:
Diameter: 17cm / 7"
Height: 31cm / 12"

WALL LIGHTS - BROOKLYN VINTAGE ANTIQUE SCONCE - DOME

All of Industville designs are authentic and unique, having been inspired by the industrial and factory lighting of the late nineteenth and early twentieth century. Designed to reflect the true utilitarian function of this lighting style with classic lines and exposed hardware; they show the same attention to detail required for their original industrial purpose. At Industville, we endeavour to produce products that effectively combine good design and exceptional value without compromising quality. Perfect to bring vintage charm and the industrial look and feel into any interior space.

Industville offers a huge range of sizes and options, including a variety of holders and finishes in addition to a variety of energy efficient LED filament bulbs, to enable you to tailor your lighting choices to any style or size of project.

The strength of our company lies in the fact that our products are available in large numbers and offer the look and feel of vintage, retro industrial lighting without the cost and time-constraints of searching for originals. Nevertheless, as they are all hand finished by our skilled craftsmen in our dedicated factory, therefore all our products retain a unique and individual quality which remains true to the ethos and appeal of industrial lighting

Electrical Installation

- Ensure the electrical supply is switched off
- Ensure that the electrical circuit to which this fitting is to be connected has been installed and fused in accordance with current IEE wiring regulations, BS7671.
- Products must also be installed in accordance with UK Building Regulations where applicable.
- Position the fitting where desired and confirm the method of fixing which will be required: wood screw for wood, or wood screw/ wall plug for brick and masonry
- Carefully identify the location of the mains supply cable and any other cables in the area in which you intend to fix the lamp in order to avoid damage during installation.
- Carefully support the holder during the following wiring/ connection procedure.
- Using the connector block supplied, carefully connect your lamp to the housing wiring as detailed in the following diagram

Household supply

Neutral Loop - Blue or black

Earth Loop - Green/Yellow sleeved Copper

Switch Wires- Blue with Brown sheathing or
(Black with Red Sheathing)

Live Loop- Brown or (Red)

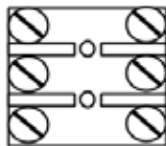

Light Fitting

Blue(N)

Green/Yellow

Brown

No connection
to light fitting

Electrical Installation - Continued

- Double check that all connections are tight. Ensure that the inner insulation is only stripped back sufficient to make a good contact in the terminal block.
- Carefully bind the terminal block and the cable either side with insulation tape (not supplied) ensuring that tape fully covers the cable to beyond the point where the outer insulation has been stripped.
- Install the mounting bracket using mounting screws (not provided, please refer to page 7)
- Screw the threaded rod from the ceiling rose to the mounting bracket and secure into place.

Assembly

These wall fitting are completely pre wired and only require a small amount of assembly after connection to the mains wiring as follows:

- Once the wall holder is installed, unscrew the black ring (see page 6)
- Hold the shade in place onto the holder
- Once in place begin to screw the black ring.
- Once secure it will hold the shade to the holder, your Brooklyn wall sconce now installed.

SPECIFICATIONS

Category

We meet all UK and EU lighting and safety regulations.

Edison screw E27 lamp-holders are fitted as standard.

Shade reveals and protects the bulb

Dimensions include any shades supplied complete with fitting.

Please note: all our products are hand finished to ensure an authentic vintage look and therefore they may vary slightly from those shown in the images.

Finishes available: Antique Brass , Dark Pewter , Copper

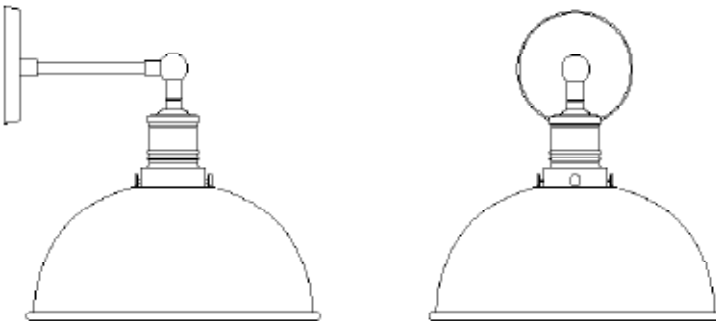

Dimensions:
Diameter: 12cm / 4.5"
Height: 20cm / 8"

WALL LIGHTS - BROOKLYN VINTAGE ANTIQUE RIBBED GLASS - FUNNEL

All of Industville designs are authentic and unique, having been inspired by the industrial and factory lighting of the late nineteenth and early twentieth century. Designed to reflect the true utilitarian function of this lighting style with classic lines and exposed hardware; they show the same attention to detail required for their original industrial purpose. At Industville, we endeavour to produce products that effectively combine good design and exceptional value without compromising quality. Perfect to bring vintage charm and the industrial look and feel into any interior space.

Industville offers a huge range of sizes and options, including a variety of holders and finishes in addition to a variety of energy efficient LED filament bulbs, to enable you to tailor your lighting choices to any style or size of project.

The strength of our company lies in the fact that our products are available in large numbers and offer the look and feel of vintage, retro industrial lighting without the cost and time-constraints of searching for originals. Nevertheless, as they are all hand finished by our skilled craftsmen in our dedicated factory, therefore all our products retain a unique and individual quality which remains true to the ethos and appeal of industrial lighting

Electrical Installation

- Ensure the electrical supply is switched off
- Ensure that the electrical circuit to which this fitting is to be connected has been installed and fused in accordance with current IEE wiring regulations, BS7671.
- Products must also be installed in accordance with UK Building Regulations where applicable.
- Position the fitting where desired and confirm the method of fixing which will be required: wood screw for wood, or wood screw/ wall plug for brick and masonry
- Carefully identify the location of the mains supply cable and any other cables in the area in which you intend to fix the lamp in order to avoid damage during installation.
- Carefully support the holder during the following wiring/ connection procedure.
- Using the connector block supplied, carefully connect your lamp to the housing wiring as detailed in the following diagram

Household supply

Neutral Loop - Blue or black

Earth Loop - Green/Yellow sleeved Copper

Switch Wires- Blue with Brown sheathing or
(Black with Red Sheathing)

Live Loop- Brown or (Red)

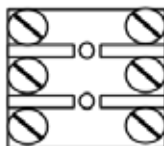

Light Fitting

Blue(N)

Green/Yellow

Brown

No connection
to light fitting

Electrical Installation - Continued

- Double check that all connections are tight. Ensure that the inner insulation is only stripped back sufficient to make a good contact in the terminal block.
- Carefully bind the terminal block and the cable either side with insulation tape (not supplied) ensuring that tape fully covers the cable to beyond the point where the outer insulation has been stripped.
- Install the mounting bracket using mounting screws (screws not provided, please refer to page 7)
- Screw the threaded rod from the ceiling rose to the mounting bracket and secure into place.

Assembly

These wall fitting are completely pre wired and only require a small amount of assembly after connection to the mains wiring as follows:

Caution- Fragile item, extra care needed when installing

- Once the wall holder is Installed, unscrew the screws from the holder
- Hold the glass shade into place
- Once in place begin to screw the screws back into the holder just enough to hold the shade, taking extra care not to screw to tightly onto the glass .
- Once secure it will hold the shade to the holder, your Brooklyn wall sconce now installed.

SPECIFICATIONS

Category

We meet all UK and EU lighting and safety regulations.

Edison screw E27 lamp-holders are fitted as standard.

Shade reveals and protects the bulb

Dimensions include any shades supplied complete with fitting.

Please note: all our products are hand finished to ensure an authentic vintage look and therefore they may vary slightly from those shown in the images.

Finishes available: Antique Brass , Dark Pewter , Copper

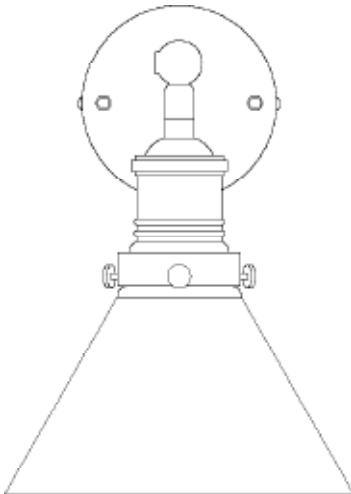

Dimensions:
Diameter: 17.5cm / 7"
Height: 21.5cm / 8.5"

WALL LIGHTS - BROOKLYN VINTAGE ANTIQUE GLASS SCONCE

All of Industville designs are authentic and unique, having been inspired by the industrial and factory lighting of the late nineteenth and early twentieth century. Designed to reflect the true utilitarian function of this lighting style with classic lines and exposed hardware; they show the same attention to detail required for their original industrial purpose. At Industville, we endeavour to produce products that effectively combine good design and exceptional value without compromising quality. Perfect to bring vintage charm and the industrial look and feel into any interior space.

Industville offers a huge range of sizes and options, including a variety of holders and finishes in addition to a variety of energy efficient LED filament bulbs, to enable you to tailor your lighting choices to any style or size of project.

The strength of our company lies in the fact that our products are available in large numbers and offer the look and feel of vintage, retro industrial lighting without the cost and time-constraints of searching for originals. Nevertheless, as they are all hand finished by our skilled craftsmen in our dedicated factory, therefore all our products retain a unique and individual quality which remains true to the ethos and appeal of industrial lighting

Electrical Installation

- Ensure the electrical supply is switched off
- Ensure that the electrical circuit to which this fitting is to be connected has been installed and fused in accordance with current IEE wiring regulations, BS7671.
- Products must also be installed in accordance with UK Building Regulations where applicable.
- Position the fitting where desired and confirm the method of fixing which will be required: wood screw for wood, or wood screw/ wall plug for brick and masonry
- Carefully identify the location of the mains supply cable and any other cables in the area in which you intend to fix the lamp in order to avoid damage during installation.
- Carefully support the holder during the following wiring/ connection procedure.
- Using the connector block supplied, carefully connect your lamp to the housing wiring as detailed in the following diagram

Household supply

Light Fitting

Neutral Loop - Blue or black

Earth Loop - Green/Yellow sleeved Copper

Switch Wires- Blue with Brown sheathing or
(Black with Red Sheathing)

Live Loop- Brown or (Red)

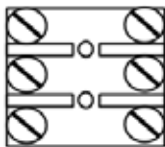

Blue(N)

Green/Yellow

Brown



No connection
to light fitting

Electrical Installation - Continued

- Double check that all connections are tight. Ensure that the inner insulation is only stripped back sufficient to make a good contact in the terminal block.
- Carefully bind the terminal block and the cable either side with insulation tape (Not supplied) Ensuring that tape fully covers the cable to beyond the point where the outer insulation has been stripped.
- Install the mounting bracket using mounting screws (screws not provided, please refer to page 7)
- Screw the threaded rod from the ceiling rose to the mounting bracket and secure into place.

Assembly

These wall fitting are completely pre wired and only require a small amount of assembly after connection to the mains wiring as follows:

Caution- Fragile item, extra care needed when installing

- Once the wall holder is Installed, unscrew the screws from the holder
- Hold the glass shade into place
- Once in place begin to screw the screws back into the holder just enough to hold the shade, taking extra care not to screw to tightly onto the glass . Once secure it will hold the shade to the holder, your Brooklyn wall sconce now installed.

SPECIFICATIONS

Category

We meet all UK and EU lighting and safety regulations.

Edison screw E27 lamp-holders are fitted as standard.

Shade reveals and protects the bulb

Dimensions include any shades supplied complete with fitting.

Please note: all our products are hand finished to ensure an authentic vintage look and therefore they may vary slightly from those shown in the images.

Finishes available: Antique Brass, Dark Pewter, Copper

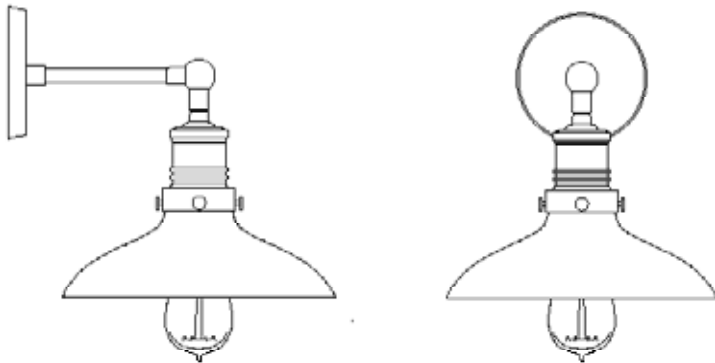

Dimensions:
Diameter: 20cm / 8"
Height: 23cm / 9"

WALL LIGHTS - ORLANDO VINTAGE CAGE

All of Industville designs are authentic and unique, having been inspired by the industrial and factory lighting of the late nineteenth and early twentieth century. Designed to reflect the true utilitarian function of this lighting style with classic lines and exposed hardware; they show the same attention to detail required for their original industrial purpose. At Industville, we endeavour to produce products that effectively combine good design and exceptional value without compromising quality. Perfect to bring vintage charm and the industrial look and feel into any interior space.

Industville offers a huge range of sizes and options, including a variety of holders and finishes in addition to a variety of energy efficient LED filament bulbs, to enable you to tailor your lighting choices to any style or size of project.

The strength of our company lies in the fact that our products are available in large numbers and offer the look and feel of vintage, retro industrial lighting without the cost and time-constraints of searching for originals. Nevertheless, as they are all hand finished by our skilled craftsmen in our dedicated factory, therefore all our products retain a unique and individual quality which remains true to the ethos and appeal of industrial lighting

Electrical Installation

- Ensure the electrical supply is switched off
- Ensure that the electrical circuit to which this fitting is to be connected has been installed and fused in accordance with current IEE wiring regulations, BS7671.
- Products must also be installed in accordance with UK Building Regulations where applicable.
- Position the fitting where desired and confirm the method of fixing which will be required: wood screw for wood, or wood screw/ wall plug for brick and masonry
- Carefully identify the location of the mains supply cable and any other cables in the area in which you intend to fix the lamp in order to avoid damage during installation.
- Carefully support the holder during the following wiring/ connection procedure.
- Using the connector block supplied, carefully connect your lamp to the housing wiring as detailed in the following diagram

Household supply

Light Fitting

Neutral Loop - Blue or black

Earth Loop - Green/Yellow sleeved Copper

Switch Wires- Blue with Brown sheathing or
(Black with Red Sheathing)

Live Loop- Brown or (Red)

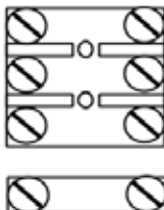

Blue(N)

Green/Yellow

Brown

No connection
to light fitting

Electrical Installation - Continued

- Double check that all connections are tight. Ensure that the inner insulation is only stripped back sufficient to make a good contact in the terminal block.
- Carefully bind the terminal block and the cable either side with insulation tape (not supplied) ensuring that tape fully covers the cable to beyond the point where the outer insulation has been stripped.
- Install the mounting bracket using mounting screws (screws not provided, please refer to page 7)
- Screw the threaded rod from the ceiling rose to the mounting bracket and secure into place.

Assembly

These ceiling fitting are completely pre-wired and only require a small amount of assembly after connection to the mains wiring as follows:

- Once the pendant holder is installed, unscrew the black ring attached to the holder (see page 6)
- Unscrew the small nut at the bottom of shade to open the cage
- Hold the cage in place and begin to screw the black ring
- Install the bulb and screw back the small nut.
- Once secure it will hold the shade to the holder, your Orlando wall light is now installed.

SPECIFICATIONS

Category

We meet all UK and EU lighting and safety regulations.

Edison screw E27 lamp-holders are fitted as standard.

Shade reveals and protects bulb

Dimensions include any shades supplied complete with fitting.

Please note: all our products are hand finished to ensure an authentic vintage look and therefore they may vary slightly from those shown in the images.

Finishes available: Antique Brass Pewter Patina

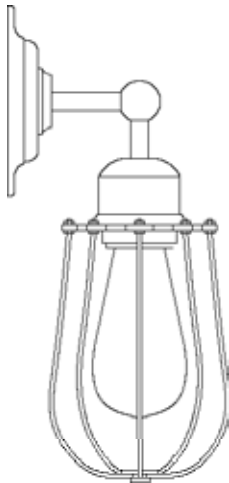

Dimensions:
Diameter: 13cm / 5"
Height: 22.5cm / 9"

WALL LIGHTS - ORLANDO CYLINDER VINTAGE CAGE RETRO WALL

All of Industville designs are authentic and unique, having been inspired by the industrial and factory lighting of the late nineteenth and early twentieth century. Designed to reflect the true utilitarian function of this lighting style with classic lines and exposed hardware; they show the same attention to detail required for their original industrial purpose. At Industville, we endeavour to produce products that effectively combine good design and exceptional value without compromising quality. Perfect to bring vintage charm and the industrial look and feel into any interior space.

Industville offers a huge range of sizes and options, including a variety of holders and finishes in addition to a variety of energy efficient LED filament bulbs, to enable you to tailor your lighting choices to any style or size of project.

The strength of our company lies in the fact that our products are available in large numbers and offer the look and feel of vintage, retro industrial lighting without the cost and time-constraints of searching for originals. Nevertheless, as they are all hand finished by our skilled craftsmen in our dedicated factory, therefore all our products retain a unique and individual quality which remains true to the ethos and appeal of industrial lighting

Electrical Installation

- Ensure the electrical supply is switched off
- Ensure that the electrical circuit to which this fitting is to be connected has been installed and fused in accordance with current IEE wiring regulations, BS7671.
- Products must also be installed in accordance with UK Building Regulations where applicable.
- Position the fitting where desired and confirm the method of fixing which will be required: wood screw for wood, or wood screw/ wall plug for brick and masonry
- Carefully identify the location of the mains supply cable and any other cables in the area in which you intend to fix the lamp in order to avoid damage during installation.
- Carefully support the holder during the following wiring/ connection procedure.
- Using the connector block supplied, carefully connect your lamp to the housing wiring as detailed in the following diagram

Household supply

Light Fitting

Neutral Loop - Blue or black

Earth Loop - Green/Yellow sleeved Copper

Switch Wires- Blue with Brown sheathing or
(Black with Red Sheathing)

Live Loop- Brown or (Red)

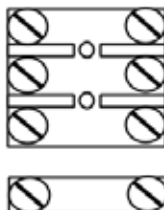

Blue(N)

Green/Yellow

Brown

No connection
to light fitting

Electrical Installation - Continued

- Double check that all connections are tight. Ensure that the inner insulation is only stripped back sufficient to make a good contact in the terminal block.
- Carefully bind the terminal block and the cable either side with insulation tape (Not supplied) Ensuring that tape fully covers the cable to beyond the point where the outer insulation has been stripped.
- Install the mounting bracket using mounting screws (not provided, please refer to page 7)
- Screw the threaded rod from the ceiling rose to the mounting bracket and secure into place.

Assembly

These ceiling fitting are completely pre-wired and only require a small amount of assembly after connection to the mains wiring as follows:

- Once the pendant holder is installed, unscrew the black ring attached to the holder (see page 6)
- Unscrew the small nut at the bottom of shade to open the cage
- Hold the cage in place and begin to screw the black ring
- Install the bulb and screw back the small nut.
- Once secure it will hold the shade to the holder, your Orlando Pendant is now installed.

SPECIFICATIONS

Category

We meet all UK and EU lighting and safety regulations.

Edison screw E27 lamp-holders are fitted as standard.

Shade reveals and protects bulb

Dimensions include any shades supplied complete with fitting.

Please note: all our products are hand finished to ensure an authentic vintage look and therefore they may vary slightly from those shown in the images.

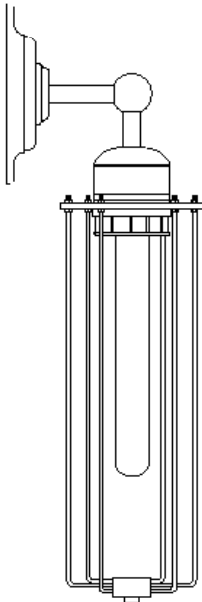

Dimensions:
Diameter: 12cm / 5"
Height: 38cm / 15"

WALL LIGHTS - ORLANDO BALLOON CAGE RETRO WALL SCNCE

All of Industville designs are authentic and unique, having been inspired by the industrial and factory lighting of the late nineteenth and early twentieth century. Designed to reflect the true utilitarian function of this lighting style with classic lines and exposed hardware; they show the same attention to detail required for their original industrial purpose. At Industville, we endeavour to produce products that effectively combine good design and exceptional value without compromising quality. Perfect to bring vintage charm and the industrial look and feel into any interior space.

Industville offers a huge range of sizes and options, including a variety of holders and finishes in addition to a variety of energy efficient LED filament bulbs, to enable you to tailor your lighting choices to any style or size of project.

The strength of our company lies in the fact that our products are available in large numbers and offer the look and feel of vintage, retro industrial lighting without the cost and time-constraints of searching for originals. Nevertheless, as they are all hand finished by our skilled craftsmen in our dedicated factory, therefore all our products retain a unique and individual quality which remains true to the ethos and appeal of industrial lighting

Electrical Installation

- Ensure the electrical supply is switched off
- Ensure that the electrical circuit to which this fitting is to be connected has been installed and fused in accordance with current IEE wiring regulations, BS7671.
- Products must also be installed in accordance with UK Building Regulations where applicable.
- Position the fitting where desired and confirm the method of fixing which will be required: wood screw for wood, or wood screw/ wall plug for brick and masonry
- Carefully identify the location of the mains supply cable and any other cables in the area in which you intend to fix the lamp in order to avoid damage during installation.
- Carefully support the holder during the following wiring/ connection procedure.
- Using the connector block supplied, carefully connect your lamp to the housing wiring as detailed in the following diagram

Household supply

Neutral Loop - Blue or black

Earth Loop - Green/Yellow sleeved Copper

Switch Wires- Blue with Brown sheathing or
(Black with Red Sheathing)

Live Loop- Brown or (Red)

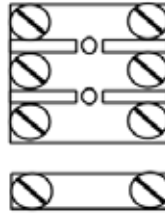

Light Fitting

Blue(N)

Green/Yellow

Brown

No connection
to light fitting

Electrical Installation - Continued

- Double check that all connections are tight. Ensure that the inner insulation is only stripped back sufficient to make a good contact in the terminal block.
- Carefully bind the terminal block and the cable either side with insulation tape (Not supplied) Ensuring that tape fully covers the cable to beyond the point where the outer insulation has been stripped.
- Install the mounting bracket using mounting screws (not provided, please refer to page 7)
- Screw the threaded rod from the ceiling rose to the mounting bracket and secure into place.

Assembly

These ceiling fitting are completely pre-wired and only require a small amount of assembly after connection to the mains wiring as follows:

- Once the pendant holder is Installed, unscrew the small screws
- Install the bulb
- Old the cage shade in place onto the holder and begin to re screw the small screws
- Once secure it will hold the shade to the holder, your Orlando Pendant is now installed.

SPECIFICATIONS

Category

We meet all UK and EU lighting and safety regulations.

Edison screw E27 lamp-holders are fitted as standard.

Shade reveals and protects bulb

Dimensions include any shades supplied complete with fitting.

Please note: all our products are hand finished to ensure an authentic vintage look and therefore they may vary slightly from those shown in the images.

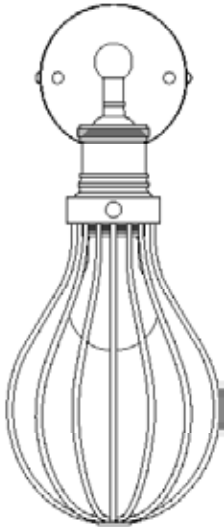

Dimensions:

Diameter: 12.5cm / 5"

Height: 35cm / 14"

WALL LIGHTS - VINTAGE ROUND SHAPED BARN SWAN NECK RETRO

All of Industville designs are authentic and unique, having been inspired by the industrial and factory lighting of the late nineteenth and early twentieth century. Designed to reflect the true utilitarian function of this lighting style with classic lines and exposed hardware; they show the same attention to detail required for their original industrial purpose. At Industville, we endeavour to produce products that effectively combine good design and exceptional value without compromising quality. Perfect to bring vintage charm and the industrial look and feel into any interior space.

Industville offers a huge range of sizes and options, including a variety of holders and finishes in addition to a variety of energy efficient LED filament bulbs, to enable you to tailor your lighting choices to any style or size of project.

The strength of our company lies in the fact that our products are available in large numbers and offer the look and feel of vintage, retro industrial lighting without the cost and time-constraints of searching for originals. Nevertheless, as they are all hand finished by our skilled craftsmen in our dedicated factory, therefore all our products retain a unique and individual quality which remains true to the ethos and appeal of industrial lighting

Electrical Installation

- Ensure the electrical supply is switched off
- Ensure that the electrical circuit to which this fitting is to be connected has been installed and fused in accordance with current IEE wiring regulations, BS7671.
- Products must also be installed in accordance with UK Building Regulations where applicable.
- Position the fitting where desired and confirm the method of fixing which will be required: wood screw for wood, or wood screw/ wall plug for brick and masonry
- Carefully identify the location of the mains supply cable and any other cables in the area in which you intend to fix the lamp in order to avoid damage during installation.
- Carefully support the holder during the following wiring/ connection procedure.
- Using the connector block supplied, carefully connect your lamp to the housing wiring as detailed in the following diagram

Household supply

Neutral Loop - Blue or black

Earth Loop - Green/Yellow sleeved Copper

Switch Wires- Blue with Brown sheathing or
(Black with Red Sheathing)

Live Loop- Brown or (Red)

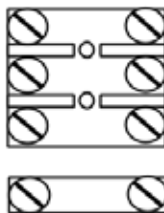

Light Fitting

Blue(N)

Green/Yellow

Brown

No connection
to light fitting

Electrical Installation - Continued

- Double check that all connections are tight. Ensure that the inner insulation is only stripped back sufficient to make a good contact in the terminal block.
- Carefully bind the terminal block and the cable either side with insulation tape (not supplied) ensuring that tape fully covers the cable to beyond the point where the outer insulation has been stripped.
- Install the mounting bracket using mounting screws (screws not provided)
- Screw the threaded rod from the ceiling rose to the mounting bracket and secure into place.

Assembly

These ceiling fitting are completely pre-wired and only require a small amount of assembly after connection to the mains wiring as follows:

- Once the pendant holder is Installed, unscrew the black ring
- Hold the shade in place onto the holder
- Once in place begin to screw the black ring. Once secure it will hold the shade to the holder, your Wall fitting is now installed.

SPECIFICATIONS

Category

We meet all UK and EU lighting and safety regulations.

Edison screw E27 lamp-holders are fitted as standard.

Shade reveals and protects bulb

Dimensions include any shades supplied complete with fitting.

Please note: all our products are hand finished to ensure an authentic vintage look and therefore they may vary slightly from those shown in the images.

Finishes available: Antique Brass Pewter Patina

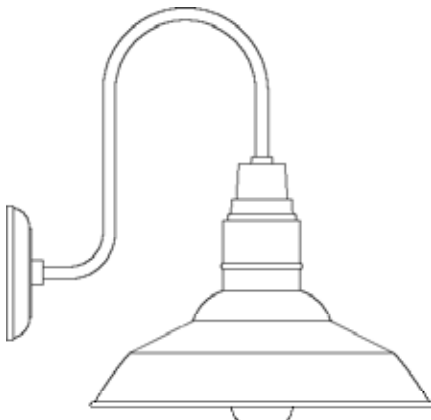

Dimensions:

Diameter: 27cm/ 10.5"

Height: 32cm/ 12.5"

WALL LIGHTS - VINTAGE CONE SHAPED BARN SWAN NECK RETRO

All of Industville designs are authentic and unique, having been inspired by the industrial and factory lighting of the late nineteenth and early twentieth century. Designed to reflect the true utilitarian function of this lighting style with classic lines and exposed hardware; they show the same attention to detail required for their original industrial purpose. At Industville, we endeavour to produce products that effectively combine good design and exceptional value without compromising quality. Perfect to bring vintage charm and the industrial look and feel into any interior space.

Industville offers a huge range of sizes and options, including a variety of holders and finishes in addition to a variety of energy efficient LED filament bulbs, to enable you to tailor your lighting choices to any style or size of project.

The strength of our company lies in the fact that our products are available in large numbers and offer the look and feel of vintage, retro industrial lighting without the cost and time-constraints of searching for originals. Nevertheless, as they are all hand finished by our skilled craftsmen in our dedicated factory, therefore all our products retain a unique and individual quality which remains true to the ethos and appeal of industrial lighting

Electrical Installation

- Ensure the electrical supply is switched off
- Ensure that the electrical circuit to which this fitting is to be connected has been installed and fused in accordance with current IEE wiring regulations, BS7671.
- Products must also be installed in accordance with UK Building Regulations where applicable.
- Position the fitting where desired and confirm the method of fixing which will be required: wood screw for wood, or wood screw/ wall plug for brick and masonry
- Carefully identify the location of the mains supply cable and any other cables in the area in which you intend to fix the lamp in order to avoid damage during installation.
- Carefully support the holder during the following wiring/ connection procedure.
- Using the connector block supplied, carefully connect your lamp to the housing wiring as detailed in the following diagram

Household supply

Neutral Loop - Blue or black

Earth Loop - Green/Yellow sleeved Copper

Switch Wires- Blue with Brown sheathing or
(Black with Red Sheathing)

Live Loop- Brown or (Red)

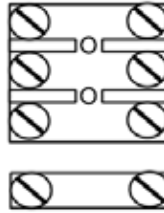

Light Fitting

Blue(N)

Green/Yellow

Brown

No connection
to light fitting

Electrical Installation - Continued

- Double check that all connections are tight. Ensure that the inner insulation is only stripped back sufficient to make a good contact in the terminal block.
- Carefully bind the terminal block and the cable either side with insulation tape (not supplied) ensuring that tape fully covers the cable to beyond the point where the outer insulation has been stripped.
- Install the mounting bracket using mounting screws (screws not provided)
- Screw the threaded rod from the ceiling rose to the mounting bracket and secure into place.

Assembly

These ceiling fitting are completely pre-wired and only require a small amount of assembly after connection to the mains wiring as follows:

- Once the pendant holder is installed, unscrew the black ring
- Hold the shade in place onto the holder
- Once in place begin to screw the black ring. Once secure it will hold the shade to the holder, your wall fitting is now installed.

SPECIFICATIONS

Category

We meet all UK and EU lighting and safety regulations.

Edison screw E27 lamp-holders are fitted as standard.

Shade reveals and protects bulb

Dimensions include any shades supplied complete with fitting.

Please note: all our products are hand finished to ensure an authentic vintage look and therefore they may vary slightly from those shown in the images.

Finishes available: Antique Brass Pewter Patina

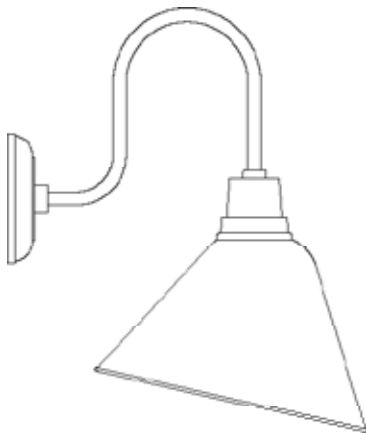

Dimensions:

Diameter: 13cm/ 5"

Height: 21cm/ 8"

WALL LIGHTS -

VINTAGE ADJUSTABLE SWIVEL SPOTLIGHT WALL LIGHT - SINGLE

All of Industville designs are authentic and unique, having been inspired by the industrial and factory lighting of the late nineteenth and early twentieth century. Designed to reflect the true utilitarian function of this lighting style with classic lines and exposed hardware; they show the same attention to detail required for their original industrial purpose. At Industville, we endeavour to produce products that effectively combine good design and exceptional value without compromising quality. Perfect to bring vintage charm and the industrial look and feel into any interior space.

Industville offers a huge range of sizes and options, including a variety of holders and finishes in addition to a variety of energy efficient LED filament bulbs, to enable you to tailor your lighting choices to any style or size of project.

The strength of our company lies in the fact that our products are available in large numbers and offer the look and feel of vintage, retro industrial lighting without the cost and time-constraints of searching for originals. Nevertheless, as they are all hand finished by our skilled craftsmen in our dedicated factory, therefore all our products retain a unique and individual quality which remains true to the ethos and appeal of industrial lighting

Electrical Installation

- Ensure the electrical supply is switched off
- Ensure that the electrical circuit to which this fitting is to be connected has been installed and fused in accordance with current IEE wiring regulations, BS7671.
- Products must also be installed in accordance with UK Building Regulations where applicable.
- Position the fitting where desired and confirm the method of fixing which will be required: wood screw for wood, or wood screw/ wall plug for brick and masonry
- Carefully identify the location of the mains supply cable and any other cables in the area in which you intend to fix the lamp in order to avoid damage during installation.
- Carefully support the holder during the following wiring/ connection procedure.
- Using the connector block supplied, carefully connect your lamp to the housing wiring as detailed in the following diagram

Household supply

Neutral Loop - Blue or black

Earth Loop - Green/Yellow sleeved Copper

Switch Wires- Blue with Brown sheathing or
(Black with Red Sheathing)

Live Loop- Brown or (Red)

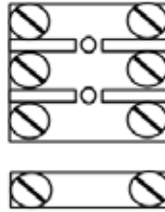

Light Fitting

Blue(N)

Green/Yellow

Brown

No connection
to light fitting

Electrical Installation - Continued

- Double check that all connections are tight. Ensure that the inner insulation is only stripped back sufficient to make a good contact in the terminal block.
- Carefully bind the terminal block and the cable either side with insulation tape (not supplied) ensuring that tape fully covers the cable to beyond the point where the outer insulation has been stripped.
- Install the mounting bracket using mounting screws (screws not provided)
- Screw the threaded rod from the ceiling rose to the mounting bracket and secure into place.

Assembly

These ceiling fitting are completely pre-wired and only require installation of the bulb after connection to the mains wiring.

SPECIFICATIONS

Category

We meet all UK and EU lighting and safety regulations.

Edison screw E27 lamp-holders are fitted as standard.

Shade reveals and protects bulb

Dimensions include any shades supplied complete with fitting.

Please note: all our products are hand finished to ensure an authentic vintage look and therefore they may vary slightly from those shown in the images.

Finishes available: Dark Pewter

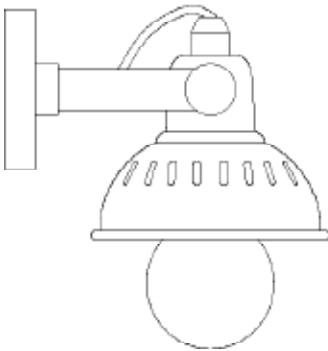

Dimensions:

Wall/ceiling mount: 8cm/ 3" x 8cm/ 3"

Shade diameter: 11cm/ 4.5"

Height as a wall light: 12cm/ 5"

Height as a flush mounted ceiling light:

20cm/ 8"

Projection as a wall light: 18cm/ 7"

WALL LIGHTS -

VINTAGE ADJUSTABLE SWIVEL SPOTLIGHT WALL LIGHT - DOUBLE

All of Industville designs are authentic and unique, having been inspired by the industrial and factory lighting of the late nineteenth and early twentieth century. Designed to reflect the true utilitarian function of this lighting style with classic lines and exposed hardware; they show the same attention to detail required for their original industrial purpose. At Industville, we endeavour to produce products that effectively combine good design and exceptional value without compromising quality. Perfect to bring vintage charm and the industrial look and feel into any interior space.

Industville offers a huge range of sizes and options, including a variety of holders and finishes in addition to a variety of energy efficient LED filament bulbs, to enable you to tailor your lighting choices to any style or size of project.

The strength of our company lies in the fact that our products are available in large numbers and offer the look and feel of vintage, retro industrial lighting without the cost and time-constraints of searching for originals. Nevertheless, as they are all hand finished by our skilled craftsmen in our dedicated factory, therefore all our products retain a unique and individual quality which remains true to the ethos and appeal of industrial lighting

Electrical Installation

- Ensure the electrical supply is switched off
- Ensure that the electrical circuit to which this fitting is to be connected has been installed and fused in accordance with current IEE wiring regulations, BS7671.
- Products must also be installed in accordance with UK Building Regulations where applicable.
- Position the fitting where desired and confirm the method of fixing which will be required: wood screw for wood, or wood screw/ wall plug for brick and masonry
- Carefully identify the location of the mains supply cable and any other cables in the area in which you intend to fix the lamp in order to avoid damage during installation.
- Carefully support the holder during the following wiring/ connection procedure.
- Using the connector block supplied, carefully connect your lamp to the housing wiring as detailed in the following diagram

Household supply

Light Fitting

Neutral Loop - Blue or black

Earth Loop - Green/Yellow sleeved Copper

Switch Wires- Blue with Brown sheathing or
(Black with Red Sheathing)

Live Loop- Brown or (Red)

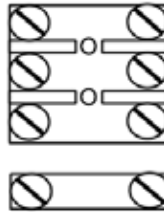

Blue(N)

Green/Yellow

Brown

No connection
to light fitting

Electrical Installation - Continued

- Double check that all connections are tight. Ensure that the inner insulation is only stripped back sufficient to make a good contact in the terminal block.
- Carefully bind the terminal block and the cable either side with insulation tape (not supplied) ensuring that tape fully covers the cable to beyond the point where the outer insulation has been stripped.
- Install the mounting bracket using mounting screws (screws not provided)
- Screw the threaded rod from the ceiling rose to the mounting bracket and secure into place.

Assembly

These ceiling fitting are completely pre-wired and only require installation of the bulb after connection to the mains wiring.

SPECIFICATIONS

Category

We meet all UK and EU lighting and safety regulations.

Edison screw E27 lamp-holders are fitted as standard.

Shade reveals and protects bulb

Dimensions include any shades supplied complete with fitting.

Please note: all our products are hand finished to ensure an authentic vintage look and therefore they may vary slightly from those shown in the images.

Finishes available: Dark Pewter

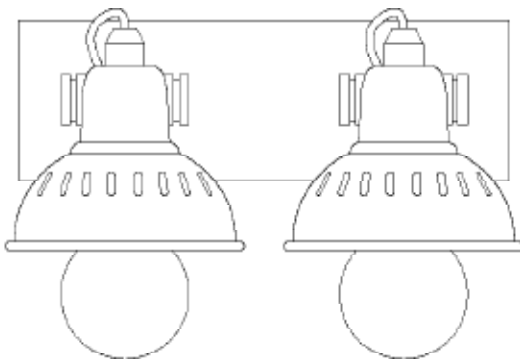

dimensions:

Wall/ceiling mount: 8.5cm/ 3.5" x 28cm/
11"

Shade diameter: 11cm/ 4.5"

Height as a wall light: 11cm/ 4.5"

Projection as a wall light: 18cm/ 7"

Height as a flush mounted ceiling light:

BULKHEADS -

VINTAGE INDUSTRIAL CAGE BULKHEAD WALL LIGHT SCONCE WITH GLASS

All of Industville designs are authentic and unique, having been inspired by the industrial and factory lighting of the late nineteenth and early twentieth century. Designed to reflect the true utilitarian function of this lighting style with classic lines and exposed hardware; they show the same attention to detail required for their original industrial purpose. At Industville, we endeavour to produce products that effectively combine good design and exceptional value without compromising quality. Perfect to bring vintage charm and the industrial look and feel into any interior space.

Industville offers a huge range of sizes and options, including a variety of holders and finishes in addition to a variety of energy efficient LED filament bulbs, to enable you to tailor your lighting choices to any style or size of project.

The strength of our company lies in the fact that our products are available in large numbers and offer the look and feel of vintage, retro industrial lighting without the cost and time-constraints of searching for originals. Nevertheless, as they are all hand finished by our skilled craftsmen in our dedicated factory, therefore all our products retain a unique and individual quality which remains true to the ethos and appeal of industrial lighting

Electrical Installation

- Ensure the electrical supply is switched off
- Ensure that the electrical circuit to which this fitting is to be connected has been installed and fused in accordance with current IEE wiring regulations, BS7671.
- Products must also be installed in accordance with UK Building Regulations where applicable.
- Position the fitting where desired and confirm the method of fixing which will be required: wood screw for wood, or wood screw/ wall plug for brick and masonry
- Carefully identify the location of the mains supply cable and any other cables in the area in which you intend to fix the lamp in order to avoid damage during installation.
- Carefully support the holder during the following wiring/ connection procedure.
- Using the connector block supplied, carefully connect your lamp to the housing wiring as detailed in the following diagram

Household supply

Neutral Loop - Blue or black

Earth Loop - Green/Yellow sleeved Copper

Switch Wires- Blue with Brown sheathing or
(Black with Red Sheathing)

Live Loop- Brown or (Red)

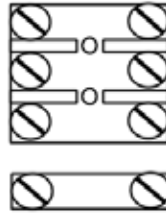

Light Fitting

Blue(N)

Green/Yellow

Brown

No connection
to light fitting

Electrical Installation - Continued

- Double check that all connections are tight. Ensure that the inner insulation is only stripped back sufficient to make a good contact in the terminal block.
- Carefully bind the terminal block and the cable either side with insulation tape (not supplied) ensuring that tape fully covers the cable to beyond the point where the outer insulation has been stripped.
- Install the mounting bracket using mounting screws (screws not provided)
- Screw the threaded rod from the ceiling rose to the mounting bracket and secure into place.

Assembly

These ceiling fitting are completely pre-wired and only require a small amount of assembly after connection to the mains wiring as follows:

Caution- Fragile item, extra care needed when installing

- The front guard is secured by 2 nuts either side of the bulkhead, unscrew these nuts in order to install the bulb
- Once installed, screw in the glass cover taking extra care not to screw too tightly and not using too much force
- Holding the front guard back into place screw back the 2 nuts taking extra care when handling the glass
- Once secure, your Bulkhead wall light is now installed.

SPECIFICATIONS

Category

We meet all UK and EU lighting and safety regulations.

Edison screw E27 lamp-holders are fitted as standard.

Shade reveals and protects bulb

Dimensions include any shades supplied complete with fitting.

Please note: all our products are hand finished to ensure an authentic vintage look and therefore they may vary slightly from those shown in the images.

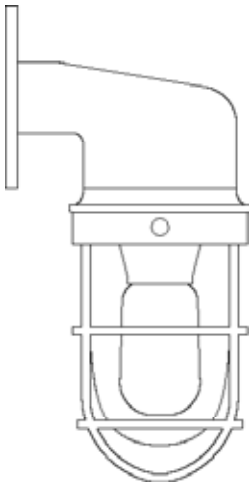

Dimensions:

Diameter: 12 cm / 5 inch

Height: 30 cm / 12 inch

BULKHEADS -

VINTAGE INDUSTRIAL HEAVY ROUND BULKHEAD RETRO WALL LIGHT/ FLUSH MOUNT

All of Industville designs are authentic and unique, having been inspired by the industrial and factory lighting of the late nineteenth and early twentieth century. Designed to reflect the true utilitarian function of this lighting style with classic lines and exposed hardware; they show the same attention to detail required for their original industrial purpose. At Industville, we endeavour to produce products that effectively combine good design and exceptional value without compromising quality. Perfect to bring vintage charm and the industrial look and feel into any interior space.

Industville offers a huge range of sizes and options, including a variety of holders and finishes in addition to a variety of energy efficient LED filament bulbs, to enable you to tailor your lighting choices to any style or size of project.

The strength of our company lies in the fact that our products are available in large numbers and offer the look and feel of vintage, retro industrial lighting without the cost and time-constraints of searching for originals. Nevertheless, as they are all hand finished by our skilled craftsmen in our dedicated factory, therefore all our products retain a unique and individual quality which remains true to the ethos and appeal of industrial lighting

Electrical Installation

- Ensure the electrical supply is switched off
- Ensure that the electrical circuit to which this fitting is to be connected has been installed and fused in accordance with current IEE wiring regulations, BS7671.
- Products must also be installed in accordance with UK Building Regulations where applicable.
- Position the fitting where desired and confirm the method of fixing which will be required: wood screw for wood, or wood screw/ wall plug for brick and masonry
- Carefully identify the location of the mains supply cable and any other cables in the area in which you intend to fix the lamp in order to avoid damage during installation.
- Carefully support the holder during the following wiring/ connection procedure.
- Using the connector block supplied, carefully connect your lamp to the housing wiring as detailed in the following diagram

Household supply

Neutral Loop - Blue or black

Earth Loop - Green/Yellow sleeved Copper

Switch Wires- Blue with Brown sheathing or
(Black with Red Sheathing)

Live Loop- Brown or (Red)

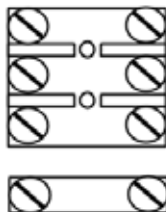

Light Fitting

Blue(N)

Green/Yellow

Brown

No connection
to light fitting

Electrical Installation - Continued

- Double check that all connections are tight. Ensure that the inner insulation is only stripped back sufficient to make a good contact in the terminal block.
- Carefully bind the terminal block and the cable either side with insulation tape (not supplied) ensuring that tape fully covers the cable to beyond the point where the outer insulation has been stripped.
- Install the mounting bracket using mounting screws (screws not provided)
- Screw the threaded rod from the ceiling rose to the mounting bracket and secure into place.

Assembly

Please note our Bulkheads have internal fixing points and a glanded surface cable entry. These fittings are completely pre-wired and only require a small amount of assembly after connection to the mains wiring as follows:

Caution- Fragile item, extra care needed when installing

- The front guard is secured by 4 wing nuts, unscrew these wing nuts in order to install the bulb
- Install the bulb (see page)
- Holding the front guard back into place screw back the 4 wing nuts taking extra care when handling the glass
- Once secure , your Bulkhead wall scone is now installed.

SPECIFICATIONS

Category

We meet all UK and EU lighting and safety regulations.

Edison screw E27 lamp-holders are fitted as standard.

Shade reveals and protects bulb

Dimensions include any shades supplied complete with fitting.

Please note: all our products are hand finished to ensure an authentic vintage look and therefore they may vary slightly from those shown in the images.

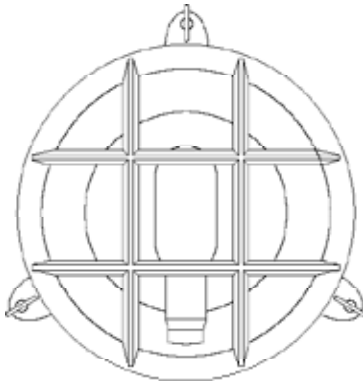

Dimensions:

Diameter: 22cm/ 9"

Height: 11cm/ 4.5"

BULKHEADS -

VINTAGE INDUSTRIAL OVAL HEAVY LAMP

All of Industville designs are authentic and unique, having been inspired by the industrial and factory lighting of the late nineteenth and early twentieth century. Designed to reflect the true utilitarian function of this lighting style with classic lines and exposed hardware; they show the same attention to detail required for their original industrial purpose. At Industville, we endeavour to produce products that effectively combine good design and exceptional value without compromising quality. Perfect to bring vintage charm and the industrial look and feel into any interior space.

Industville offers a huge range of sizes and options, including a variety of holders and finishes in addition to a variety of energy efficient LED filament bulbs, to enable you to tailor your lighting choices to any style or size of project.

The strength of our company lies in the fact that our products are available in large numbers and offer the look and feel of vintage, retro industrial lighting without the cost and time-constraints of searching for originals. Nevertheless, as they are all hand finished by our skilled craftsmen in our dedicated factory, therefore all our products retain a unique and individual quality which remains true to the ethos and appeal of industrial lighting

Electrical Installation

- Ensure the electrical supply is switched off
- Ensure that the electrical circuit to which this fitting is to be connected has been installed and fused in accordance with current IEE wiring regulations, BS7671.
- Products must also be installed in accordance with UK Building Regulations where applicable.
- Position the fitting where desired and confirm the method of fixing which will be required: wood screw for wood, or wood screw/ wall plug for brick and masonry
- Carefully identify the location of the mains supply cable and any other cables in the area in which you intend to fix the lamp in order to avoid damage during installation.
- Carefully support the holder during the following wiring/ connection procedure.
- Using the connector block supplied, carefully connect your lamp to the housing wiring as detailed in the following diagram

Household supply

Neutral Loop - Blue or black

Earth Loop - Green/Yellow sleeved Copper

Switch Wires- Blue with Brown sheathing or
(Black with Red Sheathing)

Live Loop- Brown or (Red)

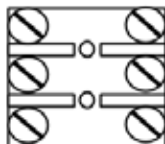

Light Fitting

Blue(N)

Green/Yellow

Brown

No connection
to light fitting

Electrical Installation - Continued

- Double check that all connections are tight. Ensure that the inner insulation is only stripped back sufficient to make a good contact in the terminal block.
- Carefully bind the terminal block and the cable either side with insulation tape (not supplied) ensuring that tape fully covers the cable to beyond the point where the outer insulation has been stripped.
- Install the mounting bracket using mounting screws (screws not provided)
- Screw the threaded rod from the ceiling rose to the mounting bracket and secure into place.

Assembly

Please note our Bulkheads have internal fixing points and a glanded surface cable entry. These fittings are completely pre-wired and only require a small amount of assembly after connection to the mains wiring as follows:

Caution- Fragile item, extra care needed when installing

- The front guard is secured by 4 wing nuts, unscrew these wing nuts in order to install the bulb
- Install the bulb (see page)
- Holding the front guard back into place screw back the 4 wing nuts taking extra care when handling the glass
- Once secure , your Bulkhead wall sconce is now installed.

SPECIFICATIONS

Category

We meet all UK and EU lighting and safety regulations.

Edison screw E27 lamp-holders are fitted as standard.

Shade reveals and protects bulb

Dimensions include any shades supplied complete with fitting.

Please note: all our products are hand finished to ensure an authentic vintage look and therefore they may vary slightly from those shown in the images.

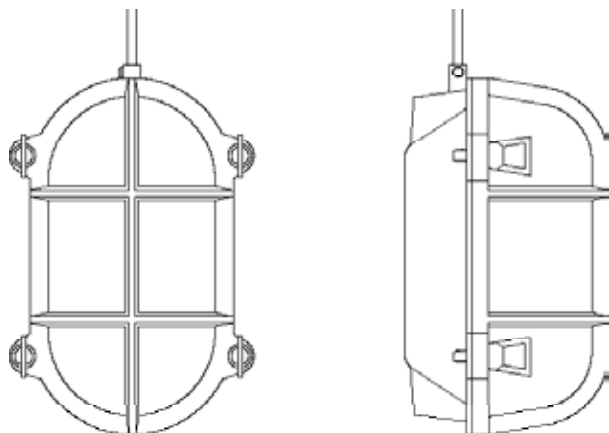

Dimensions:

Diameter: 15cm/ 6"

Height: 23cm/ 9"

BULKHEADS -

VINTAGE INDUSTRIAL HEAVY CAST BULKHEAD CAGE PENDANT - 11 INCH

All of Industville designs are authentic and unique, having been inspired by the industrial and factory lighting of the late nineteenth and early twentieth century. Designed to reflect the true utilitarian function of this lighting style with classic lines and exposed hardware; they show the same attention to detail required for their original industrial purpose. At Industville, we endeavor to produce products that effectively combine good design and exceptional value without compromising quality. Perfect to bring vintage charm and the industrial look and feel into any interior space.

As with all our light fittings, Industville offers a huge range of sizes and options, including a variety of holders, finishes and up to 30 different fabric flex variations, in addition to a variety of energy efficient LED filament bulbs, to enable you to tailor your lighting choices to any style or size of project. Our Pendants

The strength of our company lies in the fact that our products are available in large numbers and offer the look and feel of vintage, retro industrial lighting without the cost and time-constraints of searching for originals. Nevertheless, as they are all hand finished by our skilled craftsmen in our dedicated factory, therefore all our products retain a unique and individual quality which remains true to the ethos and appeal of industrial lighting.

Electrical Installation

- Ensure the electrical supply is switched off
- Ensure that the electrical circuit to which this fitting is to be connected has been installed and fused in accordance with current IEE wiring regulations, BS7671.
- Products must also be installed in accordance with UK Building Regulations where applicable.
- Position the fitting where desired and confirm the method of fixing which will be required: wood screw for wood, or wood screw/ wall plug for brick and masonry
- Carefully identify the location of the mains supply cable and any other cables in the area in which you intend to fix the lamp in order to avoid damage during installation.
- Carefully support the holder during the following wiring/ connection procedure.
- Using the connector block supplied, carefully connect your lamp to the housing wiring as detailed in the following diagram

Household supply

Light Fitting

Neutral Loop - Blue or black

Earth Loop - Green/Yellow sleeved Copper

Switch Wires- Blue with Brown sheathing or
(Black with Red Sheathing)

Live Loop- Brown or (Red)

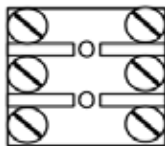

Blue(N)

Green/Yellow

Brown

No connection
to light fitting

Electrical Installation - Continued

- Double check that all connections are tight. Ensure that the inner insulation is only stripped back sufficient to make a good contact in the terminal block.
- Carefully bind the terminal block and the cable either side with insulation tape (not supplied) ensuring that tape fully covers the cable to beyond the point where the outer insulation has been stripped.
- Install the mounting bracket using mounting screws (screws not provided)
- Screw the threaded rod from the ceiling rose to the mounting bracket and secure into place.

Assembly

Please note our Bulkheads have internal fixing points and a glanded surface cable entry. These fittings are completely pre-wired and only require a small amount of assembly after connection to the mains wiring as follows:

- The front guard is secured by 4 wing nuts, unscrew these wing nuts in order to install the bulb
- Install the bulb (see page)
- Holding the front guard back into place screw back the 4 wing nuts taking extra care when handling the glass

SPECIFICATIONS

Category

We meet all UK and EU lighting and safety regulations.

Hand crafted lighting fixture

Weight of fitting- 4kg/ 12lbs

Finish: Pewter Patina

Material of shade: Metal

Please note: all our products are hand finished to ensure an authentic vintage look and therefore they may vary slightly from those shown in the images.

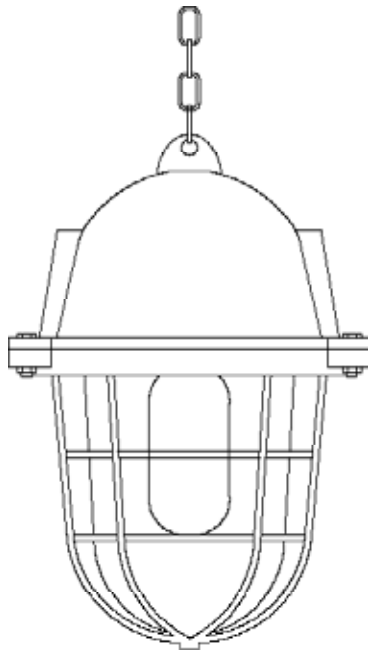

Dimensions:

Diameter: 17cm/ 7"

Height including the holder:

28cm/11"

FLUSH-MOUNTS -

VINTAGE INDUSTRIAL BARN FLUSH MOUNT CEILING LIGHTS

All of Industville designs are authentic and unique, having been inspired by the industrial and factory lighting of the late nineteenth and early twentieth century. Designed to reflect the true utilitarian function of this lighting style with classic lines and exposed hardware; they show the same attention to detail required for their original industrial purpose. At Industville, we endeavor to produce products that effectively combine good design and exceptional value without compromising quality. Perfect to bring vintage charm and the industrial look and feel into any interior space.

As with all our light fittings, Industville offers a huge range of sizes and options, including a variety of holders, finishes and up to 30 different fabric flex variations, in addition to a variety of energy efficient LED filament bulbs, to enable you to tailor your lighting choices to any style or size of project.

The strength of our company lies in the fact that our products are available in large numbers and offer the look and feel of vintage, retro industrial lighting without the cost and time-constraints of searching for originals. Nevertheless, as they are all hand finished by our skilled craftsmen in our dedicated factory, therefore all our products retain a unique and individual quality which remains true to the ethos and appeal of industrial lighting.

Electrical Installation

- Ensure the electrical supply is switched off
- Ensure that the electrical circuit to which this fitting is to be connected has been installed and fused in accordance with current IEE wiring regulations, BS7671.
- Products must also be installed in accordance with UK Building Regulations where applicable.
- Position the fitting where desired and confirm the method of fixing which will be required: wood screw for wood, or wood screw/ wall plug for brick and masonry
- Carefully identify the location of the mains supply cable and any other cables in the area in which you intend to fix the lamp in order to avoid damage during installation.
- Carefully support the holder during the following wiring/ connection procedure.
- Using the connector block supplied, carefully connect your lamp to the housing wiring as detailed in the following diagram

Household supply

Neutral Loop - Blue or black

Earth Loop - Green/Yellow sleeved Copper

Switch Wires- Blue with Brown sheathing or
(Black with Red Sheathing)

Live Loop- Brown or (Red)

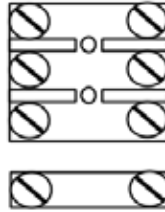

Light Fitting

Blue(N)

Green/Yellow

Brown

No connection
to light fitting

Electrical Installation - Continued

- Double check that all connections are tight. Ensure that the inner insulation is only stripped back sufficient to make a good contact in the terminal block.
- Carefully bind the terminal block and the cable either side with insulation tape (not supplied) ensuring that tape fully covers the cable to beyond the point where the outer insulation has been stripped.
- Install the mounting bracket using mounting screws (not provided, please refer to page 7)
- Screw the threaded rod from the ceiling rose to the mounting bracket and secure into place.

Assembly

These ceiling fitting are completely pre wired and only require a small amount of assembly after connection to the mains wiring as follows:

- Once the pendant holder is installed, unscrew the three copper screws
- Hold the shade in place onto the holder
- Once in place begin to screw the small copper screws. Once secure it will hold the shade to the holder, your flush-mount is now installed.

SPECIFICATIONS

Category

We meet all UK and EU lighting and safety regulations.

Edison screw E27 lamp-holders are fitted as standard.

Included: Flush mount ceiling rose in brass - ready to be installed, installation needed, ceiling mount screws not included

Dimensions include any shades supplied complete with fitting.

Please note: all our products are hand finished to ensure an authentic vintage look and therefore they may vary slightly from those shown in the images.

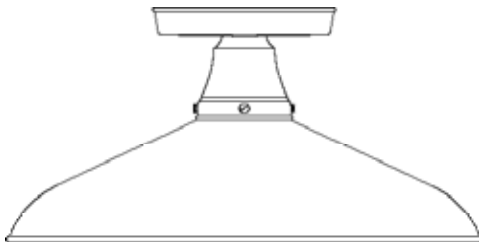

Dimensions:
Diameter: 30cm / 12"
Height: 20cm / 8"

FLUSH-MOUNTS -

VINTAGE INDUSTRIAL BARN SLOTTED MOUNT CEILING

All of Industville designs are authentic and unique, having been inspired by the industrial and factory lighting of the late nineteenth and early twentieth century. Designed to reflect the true utilitarian function of this lighting style with classic lines and exposed hardware; they show the same attention to detail required for their original industrial purpose. At Industville, we endeavor to produce products that effectively combine good design and exceptional value without compromising quality. Perfect to bring vintage charm and the industrial look and feel into any interior space.

As with all our light fittings, Industville offers a huge range of sizes and options, including a variety of holders, finishes and up to 30 different fabric flex variations, in addition to a variety of energy efficient LED filament bulbs, to enable you to tailor your lighting choices to any style or size of project.

The strength of our company lies in the fact that our products are available in large numbers and offer the look and feel of vintage, retro industrial lighting without the cost and time-constraints of searching for originals. Nevertheless, as they are all hand finished by our skilled craftsmen in our dedicated factory, therefore all our products retain a unique and

Electrical Installation

- Ensure the electrical supply is switched off
- Ensure that the electrical circuit to which this fitting is to be connected has been installed and fused in accordance with current IEE wiring regulations, BS7671.
- Products must also be installed in accordance with UK Building Regulations where applicable.
- Position the fitting where desired and confirm the method of fixing which will be required: wood screw for wood, or wood screw/ wall plug for brick and masonry
- Carefully identify the location of the mains supply cable and any other cables in the area in which you intend to fix the lamp in order to avoid damage during installation.
- Carefully support the holder during the following wiring/ connection procedure.
- Using the connector block supplied, carefully connect your lamp to the housing wiring as detailed in the following diagram

Household supply

Light Fitting

Neutral Loop - Blue or black

Earth Loop - Green/Yellow sleeved Copper

Switch Wires- Blue with Brown sheathing or
(Black with Red Sheathing)

Live Loop- Brown or (Red)

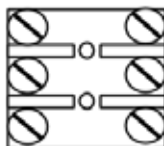

Blue(N)

Green/Yellow

Brown



No connection
to light fitting

Electrical Installation - Continued

- Double check that all connections are tight. Ensure that the inner insulation is only stripped back sufficient to make a good contact in the terminal block.
- Carefully bind the terminal block and the cable either side with insulation tape (not supplied) ensuring that tape fully covers the cable to beyond the point where the outer insulation has been stripped.
- Install the mounting bracket using mounting screws (screws not provided, please refer to page 7)
- Screw the threaded rod from the ceiling rose to the mounting bracket and secure into place.

Assembly

These ceiling fitting are completely pre wired and only require a small amount of assembly after connection to the mains wiring:

Please note that the ceiling rose has a threaded mechanism

- Detach the ceiling rose from the bulb holder
- Thread the bulb holder through the shade and then the wiring through the ceiling rose and proceed to connect to mains wiring as stated above in electrical installation
- Once in place begin to affix the ceiling rose using the appropriate mounting screws (we recommend a 4.5 screwdriver)
- After affixing the ceiling rose, use the thread screw to connect the shade with the ceiling rose. Your flush-mount is now installed.

SPECIFICATIONS

Category

We meet all UK and EU lighting and safety regulations.

Edison screw E27 lamp-holders are fitted as standard.

Included: Flush mount ceiling rose in brass - ready to be installed, installation needed, ceiling mount screws not included

Dimensions include any shades supplied complete with fitting.

Please note: all our products are hand finished to ensure an authentic vintage look and therefore they may vary slightly from those shown in the images.

Finishes available: Antique Brass Pewter Patina

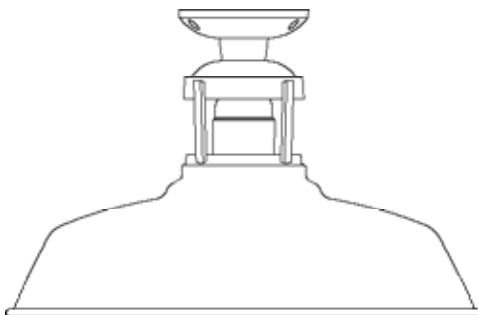

Dimensions:
Diameter: 29.5cm / 11.5"
Height: 20cm / 8"

FLUSH-MOUNTS -

VINTAGE INDUSTRIAL FLUSH MOUNT FARMHOUSE

All of Industville designs are authentic and unique, having been inspired by the industrial and factory lighting of the late nineteenth and early twentieth century. Designed to reflect the true utilitarian function of this lighting style with classic lines and exposed hardware; they show the same attention to detail required for their original industrial purpose. At Industville, we endeavor to produce products that effectively combine good design and exceptional value without compromising quality. Perfect to bring vintage charm and the industrial look and feel into any interior space.

As with all our light fittings, Industville offers a huge range of sizes and options, including a variety of holders, finishes and up to 30 different fabric flex variations, in addition to a variety of energy efficient LED filament bulbs, to enable you to tailor your lighting choices to any style or size of project.

The strength of our company lies in the fact that our products are available in large numbers and offer the look and feel of vintage, retro industrial lighting without the cost and time-constraints of searching for originals. Nevertheless, as they are all hand finished by our skilled craftsmen in our dedicated factory, therefore all our products retain a unique and individual quality which remains true to the ethos and appeal of industrial lighting.

Electrical Installation

- Ensure the electrical supply is switched off
- Ensure that the electrical circuit to which this fitting is to be connected has been installed and fused in accordance with current IEE wiring regulations, BS7671.
- Products must also be installed in accordance with UK Building Regulations where applicable.
- Position the fitting where desired and confirm the method of fixing which will be required: wood screw for wood, or wood screw/ wall plug for brick and masonry
- Carefully identify the location of the mains supply cable and any other cables in the area in which you intend to fix the lamp in order to avoid damage during installation.
- Carefully support the holder during the following wiring/ connection procedure.
- Using the connector block supplied, carefully connect your lamp to the housing wiring as detailed in the following diagram

Household supply

Neutral Loop - Blue or black

Earth Loop - Green/Yellow sleeved Copper

Switch Wires- Blue with Brown sheathing or
(Black with Red Sheathing)

Live Loop- Brown or (Red)

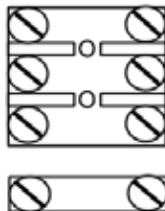

Light Fitting

Blue(N)

Green/Yellow

Brown

No connection
to light fitting

Electrical Installation - Continued

- Double check that all connections are tight. Ensure that the inner insulation is only stripped back sufficient to make a good contact in the terminal block.
- Carefully bind the terminal block and the cable either side with insulation tape (not supplied) ensuring that tape fully covers the cable to beyond the point where the outer insulation has been stripped.
- Install the mounting bracket using mounting screws (screws not provided, please refer to page 7)
- Screw the threaded rod from the ceiling rose to the mounting bracket and secure into place.

Assembly

These ceiling fitting are completely pre wired and only require a small amount of assembly after connection to the mains wiring:

Please note that the ceiling rose has a threaded mechanism

- Detach the ceiling rose from the bulb holder
- Thread the bulb holder through the shade and then the wiring through the ceiling rose and proceed to connect to mains wiring as stated above in electrical installation
- Once in place begin to affix the ceiling rose using the appropriate mounting screws (we recommend a 4.5 screwdriver)
- After affixing the ceiling rose, use the thread screw to connect the shade with the ceiling rose. Your flush-mount is now installed.

SPECIFICATIONS

Category

We meet all UK and EU lighting and safety regulations.

Edison screw E27 lamp-holders are fitted as standard.

Included: Flush mount ceiling rose in brass - ready to be installed, installation needed, ceiling mount screws not included

Dimensions include any shades supplied complete with fitting.

Please note: all our products are hand finished to ensure an authentic vintage look and therefore they may vary slightly from those shown in the images.

Finishes available: Antique Brass, Pewter Patina

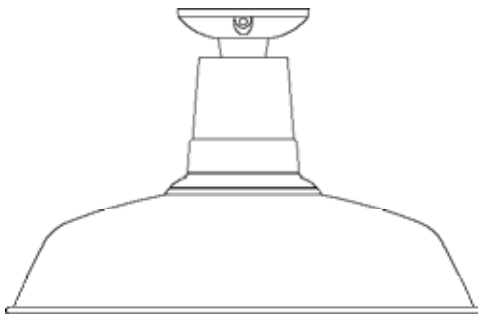

Dimensions:
Diameter: 30cm / 12"
Height: 20cm / 8"

BROOKLYN HOLDERS



WARNING

Important - Class I product **MUST** be earthed
To be used with 3 core Cable Flex



1. Using a flat screwdriver unlock the catch to remove the lampholder from casing.



2. Separate all of the components has shown



3. Pull back the fabric to expose the single insulated core on the earth cable (green/yellow), the neutral (blue) cable and strip back approx 15mm of the insulation



4. Feed one end of the 3 core flex through the top of the lampholders cable clamp



5. Twist the copper together to strengthen it, and wrap the copper clockwise around the earth screw and tighten to secure the cable in place.

Connect the remaining wires on the respective ends of the phenolic holder, as shown



6. Give it a gentle tug to make sure the connection is tight and secure



7. Cover the phenolic wired holder with the brass Brooklyn Vintage ES E27 Bulb Holder via the threaded tube as shown
Feed the casing back over the lampholder, and the screw connection over the top of the cable clamp, and slowly screw the casing together



8. Tighten the grub screw on the cable clamp to hold the cable in position



9. Feed the other end of the 3 core cable through the ceiling rose to the desired length



10. Using a termination strip, connect the live flex (brown) to the switched live, the neutral flex



11. Using a flat head screwdriver tighten the grub screw on the cable clamp to secure the cable in position

Fix the ceiling rose to the ceiling with appropriate fixings (not included)



WARNING

Important - Class I product MUST be earthed
To be used with 3 core Cable Flex

HOLDERS-

BROOKLYN VINTAGE ES E27 BULB HOLDER

All of Industville designs are authentic and unique, having been inspired by the industrial and factory lighting of the late nineteenth and early twentieth century. Designed to reflect the true utilitarian function of this lighting style with classic lines and exposed hardware; they show the same attention to detail required for their original industrial purpose. At Industville, we endeavor to produce products that effectively combine good design and exceptional value without compromising quality. Perfect to bring vintage charm and the industrial look and feel into any interior space.

As with all our light fittings, Industville offers a huge range of sizes and options, including a variety of holders, finishes and up to 30 different fabric flex variations, in addition to a variety of energy efficient LED filament bulbs, to enable you to tailor your lighting choices to any style or size of project.

The strength of our company lies in the fact that our products are available in large numbers and offer the look and feel of vintage, retro industrial lighting without the cost and time-constraints of searching for originals. Nevertheless, as they are all hand finished by our skilled craftsmen in our dedicated factory, therefore all our products retain a unique and individual quality which remains true to the ethos and appeal of industrial lighting.

Electrical Installation

- Ensure the electrical supply is switched off
- Ensure that the electrical circuit to which this fitting is to be connected has been installed and fused in accordance with current IEE wiring regulations, BS7671.
- Products must also be installed in accordance with UK Building Regulations where applicable.
- Position the fitting where desired and confirm the method of fixing which will be required: wood screw for wood, or wood screw/ wall plug for brick and masonry
- Carefully identify the location of the mains supply cable and any other cables in the area in which you intend to fix the lamp in order to avoid damage during installation.
- Carefully support the holder during the following wiring/ connection procedure.
- Using the connector block supplied, carefully connect your lamp to the housing wiring as detailed in the following diagram

Household supply

Neutral Loop - Blue or black

Earth Loop - Green/Yellow sleeved Copper

Switch Wires- Blue with Brown sheathing or
(Black with Red Sheathing)

Live Loop- Brown or (Red)

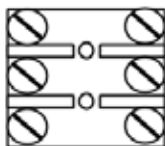

Light Fitting

Blue(N)

Green/Yellow

Brown

No connection
to light fitting

Electrical Installation - Continued

- Double check that all connections are tight. Ensure that the inner insulation is only stripped back sufficient to make a good contact in the terminal block.
- Carefully bind the terminal block and the cable either side with insulation tape (not supplied) ensuring that tape fully covers the cable to beyond the point where the outer insulation has been stripped.
- Install the mounting bracket using mounting screws (screws not provided)
- Screw the threaded rod from the ceiling rose to the mounting bracket and secure into place.

Assembly

These ceiling fitting are completely pre-wired and only require installation of the bulb after connection to the mains wiring (See page 4)

SPECIFICATIONS

Category

We meet all UK and EU lighting and safety regulations.

Edison screw E27 lamp-holders are fitted as standard.

Finishes available: Antique Brass , Dark Pewter, Copper

Cardboard insert must remain in fitting at all times for insulation purposes

Reproduction - Vintage antique industrial style, handmade finish

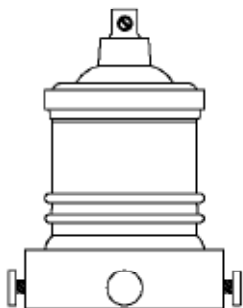

Dimensions:

31mm (diameter) x 83 mm

(depth)

HOLDERS-

BROOKLYN VINTAGE ES E27 BULB HOLDER

All of Industville designs are authentic and unique, having been inspired by the industrial and factory lighting of the late nineteenth and early twentieth century. Designed to reflect the true utilitarian function of this lighting style with classic lines and exposed hardware; they show the same attention to detail required for their original industrial purpose. At Industville, we endeavor to produce products that effectively combine good design and exceptional value without compromising quality. Perfect to bring vintage charm and the industrial look and feel into any interior space.

As with all our light fittings, Industville offers a huge range of sizes and options, including a variety of holders, finishes and up to 30 different fabric flex variations, in addition to a variety of energy efficient LED filament bulbs, to enable you to tailor your lighting choices to any style or size of project.

The strength of our company lies in the fact that our products are available in large numbers and offer the look and feel of vintage, retro industrial lighting without the cost and time-constraints of searching for originals. Nevertheless, as they are all hand finished by our skilled craftsmen in our dedicated factory, therefore all our products retain a unique and individual quality which remains true to the ethos and appeal of industrial lighting.

Electrical Installation

- Ensure the electrical supply is switched off
- Ensure that the electrical circuit to which this fitting is to be connected has been installed and fused in accordance with current IEE wiring regulations, BS7671.
- Products must also be installed in accordance with UK Building Regulations where applicable.
- Position the fitting where desired and confirm the method of fixing which will be required: wood screw for wood, or wood screw/ wall plug for brick and masonry
- Carefully identify the location of the mains supply cable and any other cables in the area in which you intend to fix the lamp in order to avoid damage during installation.
- Carefully support the holder during the following wiring/ connection procedure.
- Using the connector block supplied, carefully connect your lamp to the housing wiring as detailed in the following diagram

Household supply

Neutral Loop - Blue or black

Earth Loop - Green/Yellow sleeved Copper

Switch Wires- Blue with Brown sheathing or
(Black with Red Sheathing)

Live Loop- Brown or (Red)

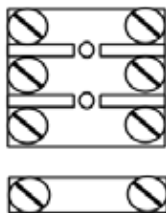

Light Fitting

Blue(N)

Green/Yellow

Brown

No connection
to light fitting

Electrical Installation - Continued

- Double check that all connections are tight. Ensure that the inner insulation is only stripped back sufficient to make a good contact in the terminal block.
- Carefully bind the terminal block and the cable either side with insulation tape (not supplied) ensuring that tape fully covers the cable to beyond the point where the outer insulation has been stripped.
- Install the mounting bracket using mounting screws (screws not provided)
- Screw the threaded rod from the ceiling rose to the mounting bracket and secure into place.

Assembly

These ceiling fitting are completely pre-wired and only require installation of the bulb after connection to the mains wiring (see page 4)

SPECIFICATIONS

Category

We meet all UK and EU lighting and safety regulations.

Edison screw E27 lamp-holders are fitted as standard.

Finishes available: Antique Brass, Dark Pewter, Copper

Cardboard insert must remain in fitting at all times for insulation purposes

Reproduction - Vintage antique industrial style, handmade finish

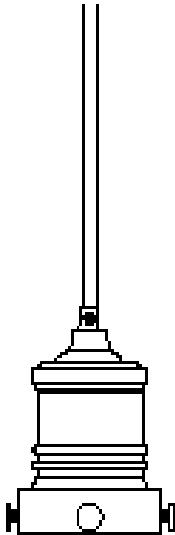

Dimensions:

31mm (diameter) x 83 mm
(depth)

HOLDERS-

BROOKLYN VINTAGE 5 WIRE PENDANT LIGHT

All of Industville designs are authentic and unique, having been inspired by the industrial and factory lighting of the late nineteenth and early twentieth century. Designed to reflect the true utilitarian function of this lighting style with classic lines and exposed hardware; they show the same attention to detail required for their original industrial purpose. At Industville, we endeavor to produce products that effectively combine good design and exceptional value without compromising quality. Perfect to bring vintage charm and the industrial look and feel into any interior space.

As with all our light fittings, Industville offers a huge range of sizes and options, including a variety of holders, finishes and up to 30 different fabric flex variations, in addition to a variety of energy efficient LED filament bulbs, to enable you to tailor your lighting choices to any style or size of project.

The strength of our company lies in the fact that our products are available in large numbers and offer the look and feel of vintage, retro industrial lighting without the cost and time-constraints of searching for originals. Nevertheless, as they are all hand finished by our skilled craftsmen in our dedicated factory, therefore all our products retain a unique and individual quality which remains true to the ethos and appeal of industrial lighting.

Electrical Installation

- Ensure the electrical supply is switched off
- Ensure that the electrical circuit to which this fitting is to be connected has been installed and fused in accordance with current IEE wiring regulations, BS7671.
- Products must also be installed in accordance with UK Building Regulations where applicable.
- Position the fitting where desired and confirm the method of fixing which will be required: wood screw for wood, or wood screw/ wall plug for brick and masonry
- Carefully identify the location of the mains supply cable and any other cables in the area in which you intend to fix the lamp in order to avoid damage during installation.
- Carefully support the holder during the following wiring/ connection procedure.
- Using the connector block supplied, carefully connect your lamp to the housing wiring as detailed in the following diagram

Household supply

Neutral Loop - Blue or black

Earth Loop - Green/Yellow sleeved Copper

Switch Wires- Blue with Brown sheathing or
(Black with Red Sheathing)

Live Loop- Brown or (Red)

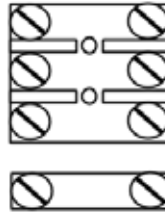

Light Fitting

Blue(N)

Green/Yellow

Brown

No connection
to light fitting

Electrical Installation - Continued

- Double check that all connections are tight. Ensure that the inner insulation is only stripped back sufficient to make a good contact in the terminal block.
- Carefully bind the terminal block and the cable either side with insulation tape (not supplied) ensuring that tape fully covers the cable to beyond the point where the outer insulation has been stripped.
- Install the mounting bracket using mounting screws (screws not provided)
- Screw the threaded rod from the ceiling rose to the mounting bracket and secure into place.

Assembly

These fittings are completely pre-wired and only require a small amount of assembly after connection to the mains wiring as follows:

- Clearly mark out the location of each arm of the pendant.
- Attach a ribbed anchor (not provided) to each hook on the pendant light.
- Once attached, hammer these hooks and anchors into the desired location, taking extra care not to use too much force.
- Once secure, install the bulbs. Your Brooklyn Pendant is now installed.

SPECIFICATIONS

Category

We meet all UK and EU lighting and safety regulations.

Edison screw E27 lamp-holders are fitted as standard.

Vintage Brooklyn 5 Wire Pendant Light - this unique pendant allows you to create your own distinctive lighting feature whether using a variety of different shades or all the same.

Includes: 1 x 5-input ceiling rose, 5 x single brass bulb sockets and 2m/78" of black round fabric flex - wired and ready to be installed

Reproduction - Vintage antique industrial style, handmade finish

Finishes available: Antique Brass

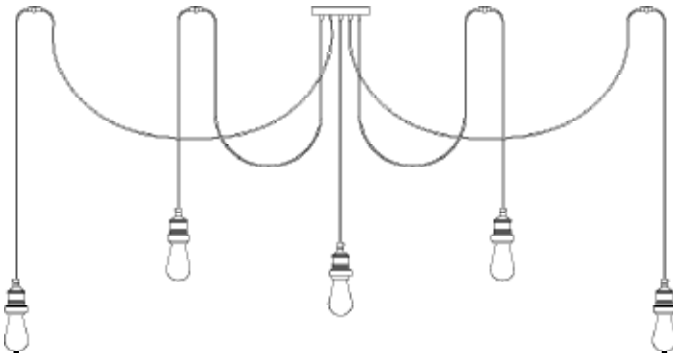

Dimensions:

31mm (diameter) x 83 mm

(depth)

HOLDERS-

VINTAGE LAMP SHADE CORD SET ES E27 BULB HOLDER - WITH CHAIN

All of Industville designs are authentic and unique, having been inspired by the industrial and factory lighting of the late nineteenth and early twentieth century. Designed to reflect the true utilitarian function of this lighting style with classic lines and exposed hardware; they show the same attention to detail required for their original industrial purpose. At Industville, we endeavor to produce products that effectively combine good design and exceptional value without compromising quality. Perfect to bring vintage charm and the industrial look and feel into any interior space.

As with all our light fittings, Industville offers a huge range of sizes and options, including a variety of holders, finishes and up to 30 different fabric flex variations, in addition to a variety of energy efficient LED filament bulbs, to enable you to tailor your lighting choices to any style or size of project.

The strength of our company lies in the fact that our products are available in large numbers and offer the look and feel of vintage, retro industrial lighting without the cost and time-constraints of searching for originals. Nevertheless, as they are all hand finished by our skilled craftsmen in our dedicated factory, therefore all our products retain a unique and individual quality which remains true to the ethos and appeal of industrial lighting.

Electrical Installation

- Ensure the electrical supply is switched off
- Ensure that the electrical circuit to which this fitting is to be connected has been installed and fused in accordance with current IEE wiring regulations, BS7671.
- Products must also be installed in accordance with UK Building Regulations where applicable.
- Position the fitting where desired and confirm the method of fixing which will be required: wood screw for wood, or wood screw/ wall plug for brick and masonry
- Carefully identify the location of the mains supply cable and any other cables in the area in which you intend to fix the lamp in order to avoid damage during installation.
- Carefully support the holder during the following wiring/ connection procedure.
- Using the connector block supplied, carefully connect your lamp to the housing wiring as detailed in the following diagram

Household supply

Light Fitting

Neutral Loop - Blue or black

Earth Loop - Green/Yellow sleeved Copper

Switch Wires- Blue with Brown sheathing or
(Black with Red Sheathing)

Live Loop- Brown or (Red)

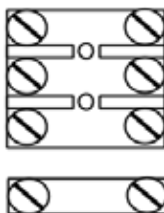

Blue(N)

Green/Yellow

Brown

No connection
to light fitting

Electrical Installation - Continued

- Double check that all connections are tight. Ensure that the inner insulation is only stripped back sufficient to make a good contact in the terminal block.
- Carefully bind the terminal block and the cable either side with insulation tape (not supplied) ensuring that tape fully covers the cable to beyond the point where the outer insulation has been stripped.
- Install the mounting bracket using mounting screws (screws not provided)
- Screw the threaded rod from the ceiling rose to the mounting bracket and secure into place.

Assembly

These ceiling fitting are completely pre-wired and only require installation of the bulb after connection to the mains wiring.

SPECIFICATIONS

Category

We meet all UK and EU lighting and safety regulations.

Edison screw E27 lamp-holders are fitted as standard.

Finishes available: Dark Pewter

Cardboard insert must remain in fitting at all times for insulation purposes

Reproduction - Vintage antique industrial style, handmade finish

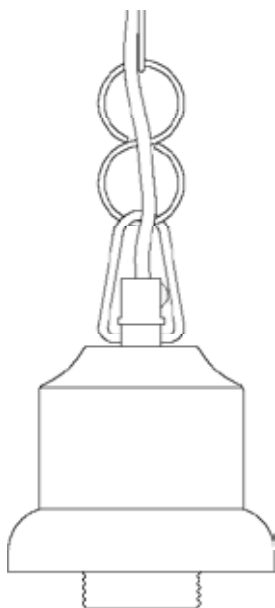

Dimensions:
31mm (diameter) x 83 mm
(depth)

Industville Ltd
218D, 1 Swan Road,
Westminster Industrial Estate,
London, SE18 5TT

020 7971 7871
info@industville.co.uk
www.industville.co.uk



INDUSTVILLE