

— EST. 1987 —

A H B

HOME FURNITURE COLLECTIONS









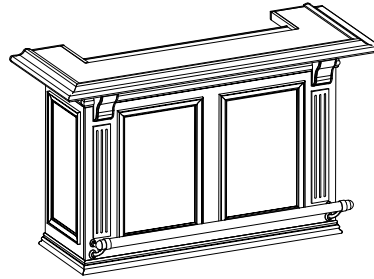

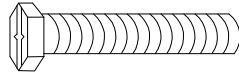

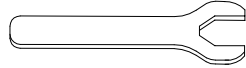
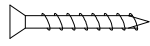

ASSEMBLY INSTRUCTIONS

SANTA MARIA BAR

DO NOT SET POWER DRILL ABOVE LEVEL 4

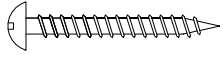
LOOSELY ATTACH EACH SCREW UNTIL FRAME IS ASSEMBLED, THEN TIGHTEN WHEN COMPLETE



	HARDWARE LIST	QTY	OUTLOOK
A	HEX BOLT(ϕ 5/16"*1-1/8mm)	2	
B	LOCK WASHER(ϕ 5/16")	2	
C	FLAT WASHER(ϕ 5/16"*19mm)	2	
D	ANCHOR	2	
E	WRENCH(12mm)	1	
F	P.H SCREW(ϕ 8*1")	2	
G	FOOT RAIL	1	
H	FOOT RAIL COVER	2	
I	SET SCREW (M5*8mm)	2	 
J	CUP HOLDER	4	
K	BAR TOP SCREW (1-1/4")	8	
L	DOOR BOLT (ϕ 5/32"*1")	4	
M	DRAWER BOLT (ϕ 5/32"*1-3/8")	4	
N	HANDLES	4	

— EST. 1987 —

A H B

HOME FURNITURE COLLECTIONS
ASSEMBLY INSTRUCTIONS
SANTA MARIA BAR

DO NOT SET POWER DRILL ABOVE LEVEL 4

LOOSELY ATTACH EACH SCREW UNTIL FRAME IS ASSEMBLED, THEN TIGHTEN WHEN COMPLETE

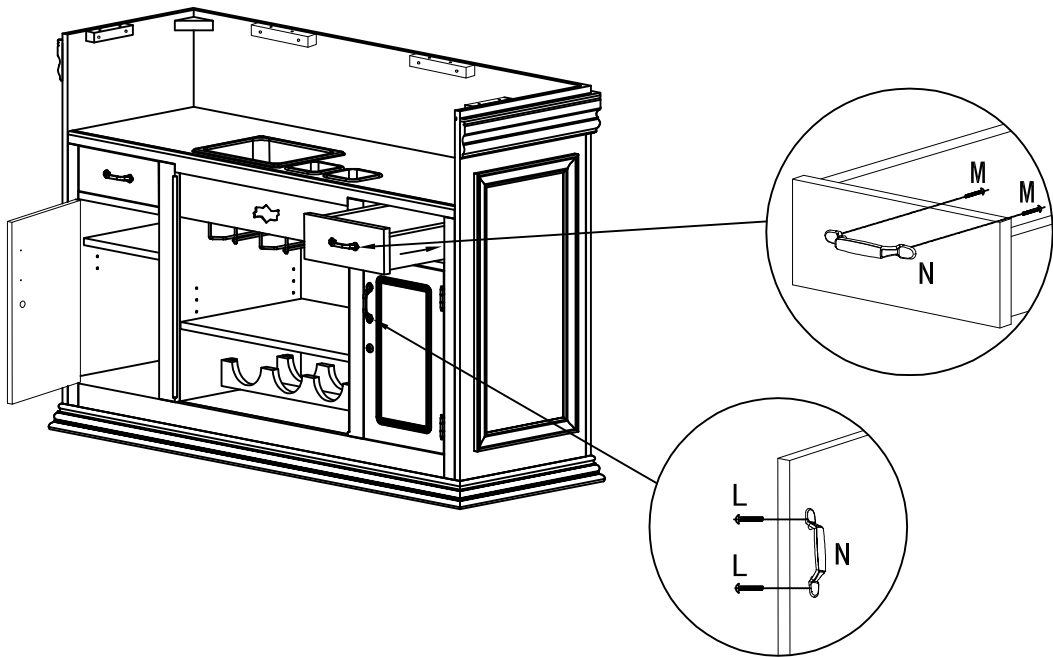

STEP 2

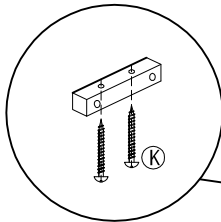

STEP 1

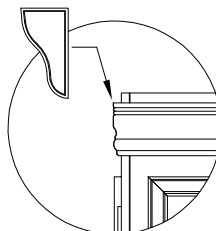

STEP 3

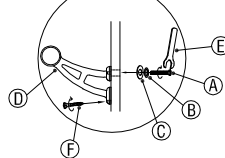

STEP 4

