

WARRANTY & MOUNTING INSTRUCTIONS



Instructions / Warranty

Congratulations on the purchase of your new Bont Skates. These skates were made with the highest standards of materials and workmanship.

Perfection, creativity, and innovation are the principles which guided the design of our Bont skate range. With over 45 years of racing heritage, experience and expertise, our boot makers are the world's best. We guarantee the irreproachable quality demanded by the World's top racers.

Heat Molding Instructions

Bont's epoxy resin is the most heat moldable boot resin on the market. Please take the time to mold your boots before use. The boot can be heat molded using your oven or a hair dryer. Remove the innersole from the boot. If your boots are made with a non-removable innersole, then it is fine to leave it in the boot. Pre heat the oven to 85°C/185°F. Place the boot in the oven for 20 minutes. Higher temperatures will void your warranty and may damage your boot. Caution: Do not place your feet in the hot boots or you may burn your feet. Let them cool a little and test the boot temperature with your hand before placing your feet in the boot.

Stand in the boot, and tighten the laces and buckle and wait for the boot to cool. You can heat mold the boots as many times as you like. If you find that the boots are not molding very easily, check your oven temperature with an external thermometer as some oven thermostats are inaccurate.

If you have any lumps or bunions on your feet or if there are any areas causing discomfort or blisters, while the boot is still warm you can use the round end of a blunt object (like a screwdriver) to press out any part of the boot.

To watch a heat molding video, go to:
<https://bont.com/pages/heat-molding>

If you have custom made boots, they may initially feel too small and may need a few weeks to break in. Make sure your foot is all the way in the back of the boot and you can also heat mold them if necessary. Custom boots are made with less thermoplastic than stock boots so they are less moldable.

Care and Maintenance

When ice skating your boots will get wet from the ice or sweat, make sure you dry them in a cool dry area out of direct sunlight. Dry your boots after each use and do not over tighten the bolts. Wet or damp boots will deteriorate a lot faster than boots that are kept dry.

Warranty

Your Bont Boots and Ice Blades have a 1 year warranty from the date of purchase. Please retain your receipt and take them back to your place of purchase if you have any problems. Please don't not contact Bont directly unless you purchased the skates directly from Bont.

Warning

Ice skating can be dangerous. Always wear protective gear whilst skating. Check your skates before each time you skate for any loose bolts or signs of stress or fatigue. Do not skate on your skates if they are in a state of disrepair. Check that the blades are secure before each use. These skates are designed for recreational and speed skating and should not be used for other types of ice skating or jumping.

BONT.COM

BLADE MOUNTING INSTRUCTIONS

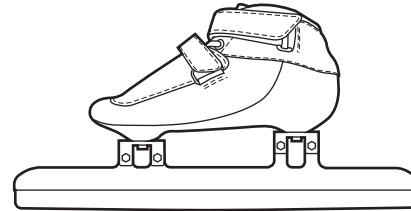
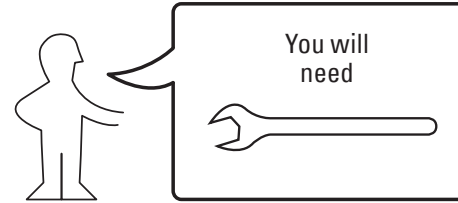

Correct mounting

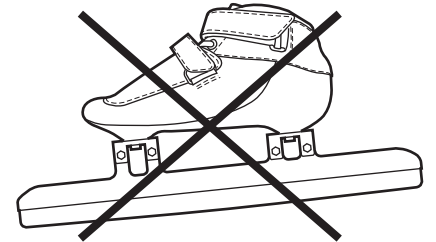

Incorrect mounting

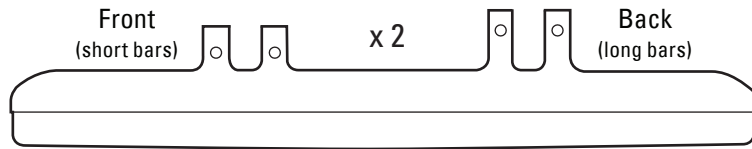
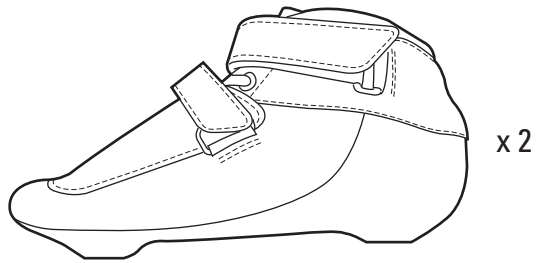

x 8

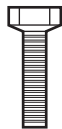

x 4



x 4

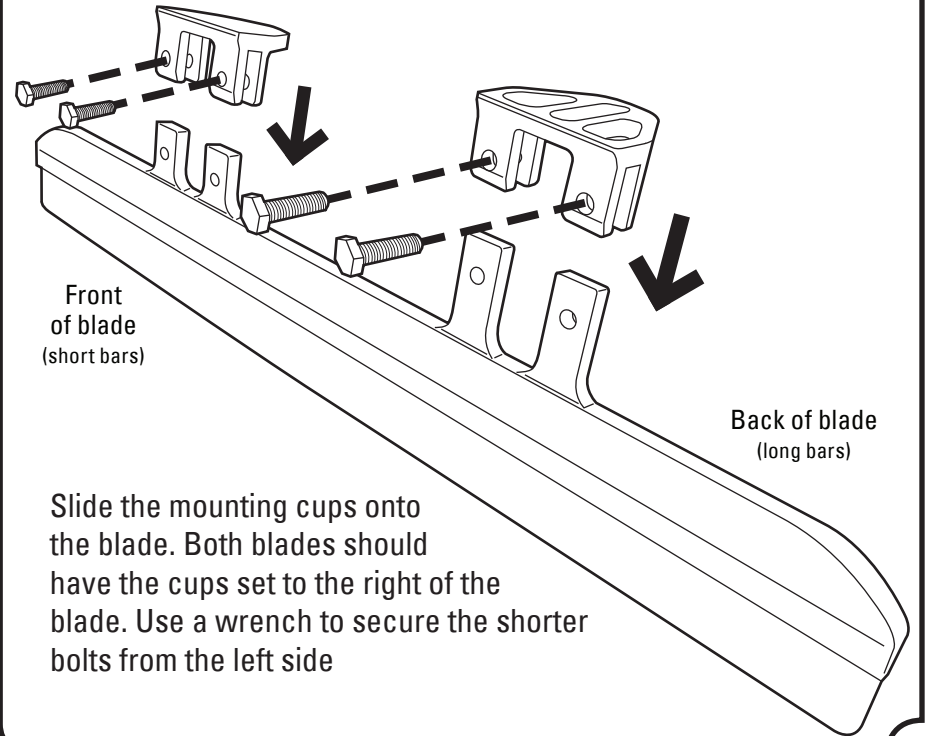
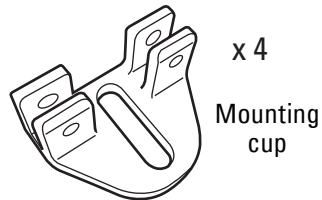

MOUNTING FOR NEW SKATERS

If you are new to short track speed skating, Bont recommends this blade arrangement

Left foot: Center the ice blade on the center of your heel at the back and center of your middle toe at the front

Right foot: Center the ice blade on the center of your heel at the back and inbetween your 1st and 2nd toe

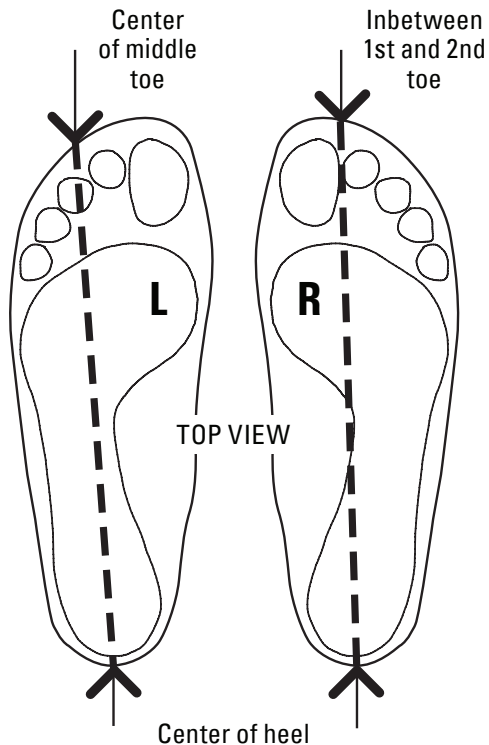

MOUNTING FOR EXPERIENCED SKATERS

If you are an experienced short track speed skater, Bont recommends this blade arrangement

Left foot: Center the ice blade off-center (left) of your heel at the back and center of your 4th toe at the front

Right foot: Center the ice blade off-center (left) of your heel at the back and middle of your 1st toe at the front

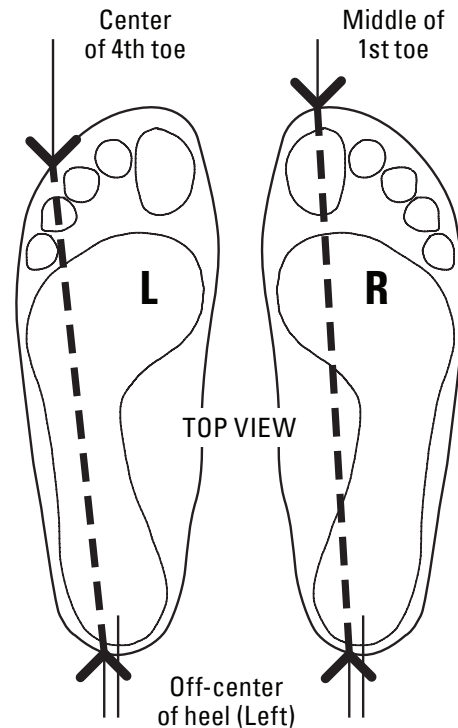

Move the front and back sliders in the boot to adjust the location of the ice blade. Note when looking at the boot from the bottom, the brackets should be on the left side of both blades

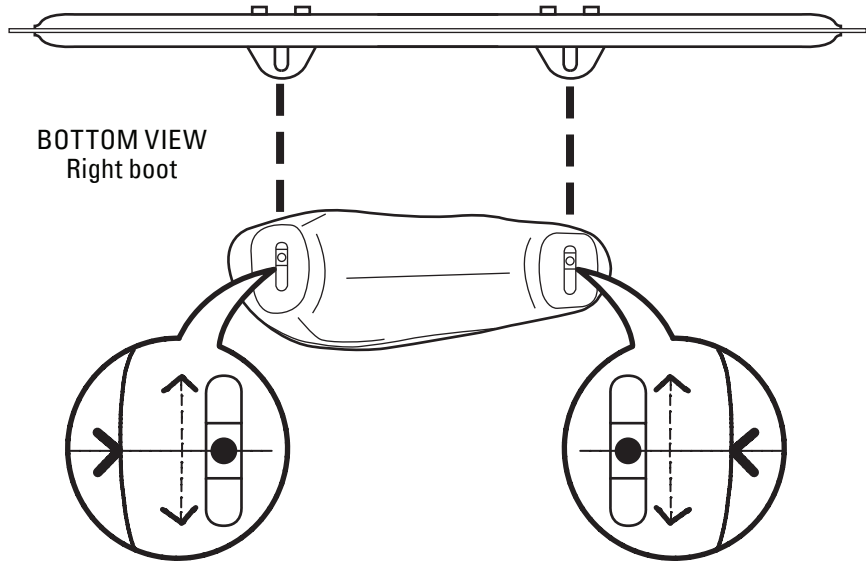

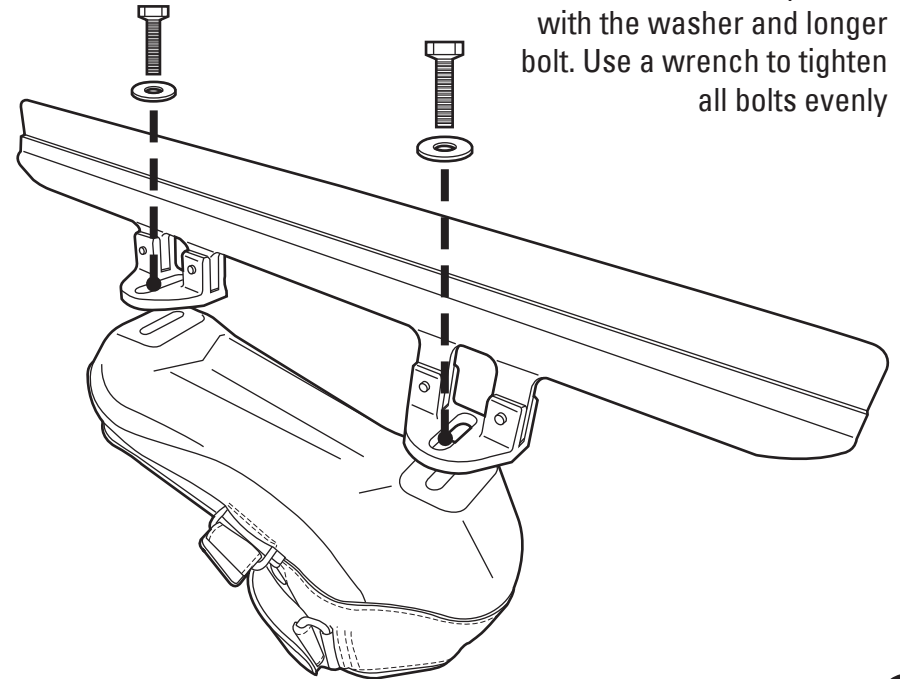

Secure the blade in position with the washer and longer bolt. Use a wrench to tighten all bolts evenly

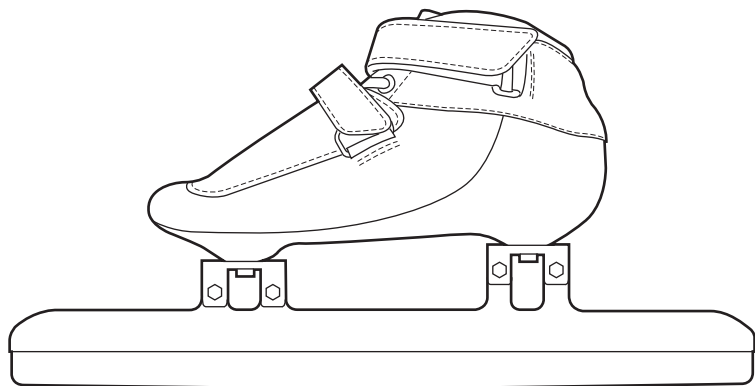



And you are done. Happy skating!
Any questions please email us at info@bont.com

KEEP UP TO DATE WITH ALL THINGS BONT

-  [@bont_inline](https://www.instagram.com/bont_inline)
-  [/BontSkates](https://www.facebook.com/BontSkates)
-  [BontSkatesInline](https://www.youtube.com/BontSkatesInline)
-  info@bont.com
-  bont.com/inline/newsletter

We hope you love your new Bont skates!



BONT.COM