

ANDOVER-ONE

TURNTABLE MUSIC SYSTEM

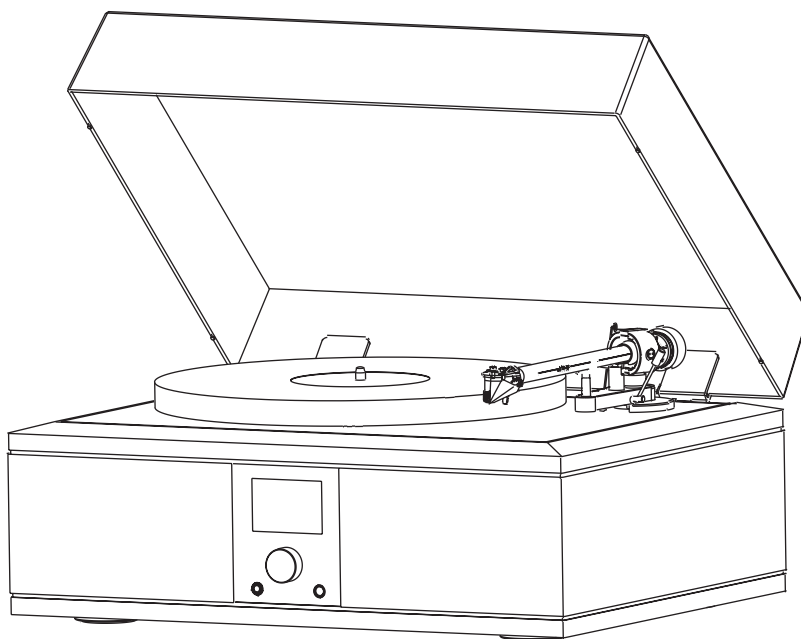

Table of Contents

Warnings / FCC Statement.....	4-5
Introduction / About / In the Box.....	6
Room Placement.....	7
Turntable Setup Guide.....	8-9
Input and Output connections.....	10
General Operation.....	11-13
Remote Control.....	14
Bluetooth & Playback to/from a PC.....	15
Record Care.....	16
Customizing Your Vinyl Experience.....	17
Warranty / Product Cleaning.....	18
Specifications / Contact / Disclaimer.....	19

WARNING

DO NOT OPEN
TO PREVENT THE RISK OF ELECTRIC
SHOCK, DO NOT REMOVE COVER. NO
USER-SERVICEABLE PARTS INSIDE.
REFER SERVICING TO QUALIFIED
SERVICE PERSONNEL.



This symbol alerts the user to the presence of uninsulated "dangerous voltage" within the product's enclosure that may be of sufficient magnitude to constitute a risk of electric shock to persons.



This symbol is intended to alert the user to the presence of important operating and maintenance (servicing) instructions in the literature accompanying the appliance.

Important Safety Instructions

1. Read these instructions.
2. Keep these instructions.
3. Heed all warnings.
4. Do not use this apparatus near water.
5. Clean only with dry cloth.
6. Do not block any ventilation openings. Install in accordance with the manufacturer's instructions.
7. Do not install near any heat sources such as radiators, heat registers, stoves, or other apparatus (including amplifiers) that produce heat.
8. Do not defeat the safety purpose of the polarized or grounding-type plug. A polarized plug has two blades with one wider than the other. A grounding type plug has two blades and a third grounding prong. The wide blade or the third prong are provided for your safety. If the provided plug does not fit into your outlet, consult an electrician for replacement of the obsolete outlet.
9. Only use attachments/accessories specified by the manufacturer.
10. Use only with the cart, stand, tripod, bracket or table specified by the manufacturer, or sold with the apparatus. When a cart is used, use caution when moving the cart/apparatus combination to avoid injury from tip-over.
11. Unplug this apparatus during lightning storms or when not used for long periods of time.
12. Refer all servicing to qualified service personnel. Servicing is required when the apparatus has been damaged in any way, such as power supply cord or plug is damaged, liquid has been spilled or objects have fallen into the apparatus, the apparatus has been exposed to rain or moisture, does not operate normally, or has been dropped.
13. The apparatus shall not be exposed to dripping or splashing and that no objects filled with liquids, such as vases, shall be placed on the apparatus.

14. Do not install this apparatus in a bookcase or similar unit.
15. The apparatus draws nominal non-operating power from the AC outlet with its STANDBY/ON switch in the standby position.
16. The apparatus should be located close enough to the AC outlet so that you can easily grasp the power cord plug at any time.
17. To completely disconnect the power input, the rear panel power switch may be switched off.
18. Excessive sound pressure from earphones and headphones can cause hearing loss.
19. The battery shall not be exposed to excessive heat such as sunshine, fire or the like.

Additional Safety Advice

1. Keep surrounding objects at least four inches away from the apparatus for adequate ventilation.
2. Ventilation openings on the apparatus should not be impeded by such items as newspaper, cloths, curtains, and the like.
3. Do not place naked flame sources near the apparatus, such as lighted candles.
4. Dispose of internal electronics in accordance with local safety and environmental regulations.
5. Do not operate the apparatus at a temperature less than 36° F / 2° C or greater than 100° F / 38° C.

Caution

- DO NOT REMOVE THE EXTERNAL ENCLOSURE PARTS TO EXPOSE THE ELECTRONICS. NO USER SERVICEABLE PARTS ARE INSIDE.
- IF YOU ARE EXPERIENCING PROBLEMS WITH THIS PRODUCT, CONTACT ANDOVER AUDIO CUSTOMER SUPPORT. DO NOT USE THE PRODUCT UNTIL IT HAS BEEN REPAIRED.

FCC STATEMENT FOR THE U.S.A.

This device complies with part 15 of the FCC rules. Operation is subject to the following two conditions: (1) This device may not cause harmful interference, and (2) this device must accept any interference received, including interference that may cause undesired operation. These limits are designed to provide reasonable protection against harmful interference in a residential installation. This equipment generates, uses, and can radiate radio frequency energy and, if not installed and used in accordance with the instructions, may cause harmful interference to radio communications. However there is no guarantee that interference will not occur in a particular installation. If this equipment does cause harmful interference to radio or television reception, which can be determined by turning the equipment off and on, the user is encouraged to try to correct the interference by one or more of the following measures:

- Reorient or relocate the equipment.
- Increase the separation between the equipment and receiver.
- Connect the equipment to an AC outlet of a different mains circuit from the main circuit/outlet providing power to the receiver.
- Consult the dealer or an experienced radio/TV technician for help.
- Changes or modification to this equipment not expressly approved by Andover for compliance will void the user's warranty.

This equipment complies with FCC radiation exposure limits set forth for an uncontrolled environment. This equipment should be installed and operated with minimum distance of 20cm between the radiator and your body.

This product can be recycled. Products bearing this symbol must NOT be thrown away with normal household waste. At the end of the product's life, take it to a collection point designated for recycling of electrical and electronic devices. Find out more about return and collection points through your local authority.

The European Waste Electrical and Electronic Equipment (WEEE) Directive was implemented to dramatically reduce the amount of waste going to landfills, thereby reducing the environmental impact on the planet and on human health. Please act responsibly by recycling used products. If this product is still usable, consider giving it away or selling it.



Warning: This product contains chemicals known to the state of California to cause cancer and birth defects or other reproductive harm. For more information: www.P65Warnings.ca.gov.

Caution

Changes or modification to this equipment not expressly approved by Andover for compliance will void the user's warranty.

Introduction

We're really pleased that you have chosen your Andover-One Turntable Music System. It is all you need to enjoy great sound from vinyl records, Bluetooth devices, and any wired analog or digital source you may wish to add. Adding our (optional) Songbird module will give your Spinsystem access to the Worldwide Web of High Resolution entertainment from the most popular streaming services and internet radio stations.

We sincerely hope that you will be overjoyed with the years of great-sounding, simple to operate, musical entertainment that the Andover-One is sure to provide.

To get the most from Andover-One, be sure to thoroughly review this manual and heed the important safety instructions. If you have any questions not covered here please contact Andover Audio support via email (support@andoveraudio.com) or phone (+1 978.775.3670).

With the proper care and operation, your Andover-One will provide many years of trouble-free enjoyment.

Please save the carton and original packaging in case you ever need to move or ship your unit.

About Andover Audio

Since 2012, we at Andover Audio have provided design and manufacturing services behind the scenes to some of the most recognized brands in mobile, professional, and high-performance consumer audio. We now focus our award-winning skills on our own product line that artfully blends exceptional sound with distinctive design.

In the Box

- Andover-One System
- Dustcover
- Quick-Setup Guide
- RF Remote Control
- Platter with Felt Mat
- OperationManual
- DC Power Supply
- Adapter to play 45RPM singles
- Flat belt for 33/45 RPM
- Round Belt for 78RPM
- Philips Screwdriver
- Tonearm Counterweight
- Anti-Skate Weight
- 7" Single Adapter
- Cartridge alignment protractor.

Room Placement

As with any sound system, placement in your room will affect how well the sound fills the space. The Andover-One features a 270-degree sound field to provide a spacious, room-enveloping performance that defies its compact size. Sound is emitted from both sides and the front of the unit, so be careful not to block the sound from the sides. Although placement of the Andover-One is less complex than a typical component system, following these simple guidelines will result in the most enjoyable sound quality.

- To ensure the most even sound coverage, try to place system near the center of one of the walls. It should be at, or slightly below, ear height for a seated listener.
- Using the Andover-One stand will place the system at the ideal height in most rooms.
- If the unit will be placed in a corner, angle it at 45-degrees so that the speakers on one side are not blocked.
- Keep the sides of the unit unobstructed by solid objects for as much distance as practical, but by at least 12" (~30.5 cm).
- Place the unit on a solid table or component rack. DO NOT use soft vibration isolators or place the unit on a carpet or foam surface. If the support surface is not sufficiently rigid, acoustic feedback may occur.
- Avoid placing the unit in an enclosed bookshelf or cabinet as this will significantly compromise its performance.

Turntable Setup Guide

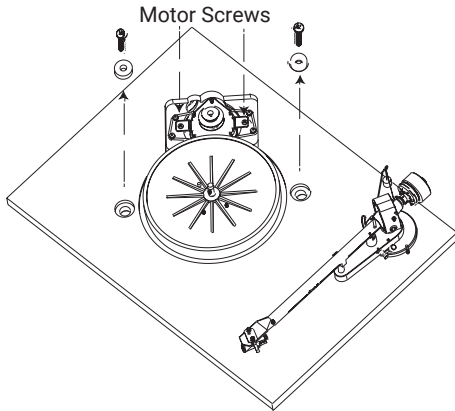

STEP 1 - Remove the Shipping Screws

- Loosen the TWO primary motor screws a few turns with a screwdriver. They can be left in place but left loose enough to allow the motor to move freely. Leave the rubber bumpers under these screws to support the motor.
- Remove the TWO large Philips shipping screws. A Philips screwdriver is included in the accessory package.
- Save all the screws and reinstall them whenever shipping or moving the unit to prevent damage.

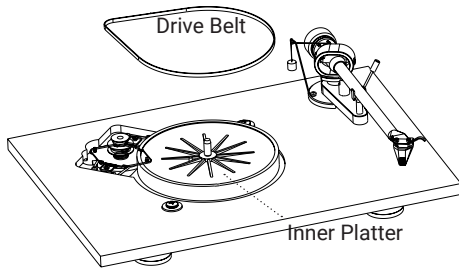

STEP 2 - Install the Drive Belt

- Install the flat drive belt by stretching it around the inner platter and over the "top step" of the small motor pulley to use with 33 or 45RPM records.
- For use with 78RPM records: Install the round drive belt on the large lower pulley instead.

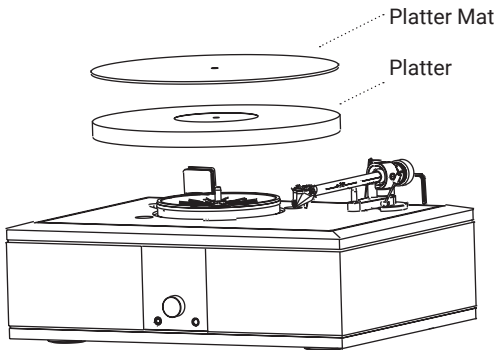

STEP 3 - Install the Platter

- With two hands, gently place the platter on the spindle, followed by the felt platter mat.
- Some users prefer to place the records directly on the Acrylic platter. This will be discussed later in the 'Customizing Your Vinyl Experience' section at the end of this manual.

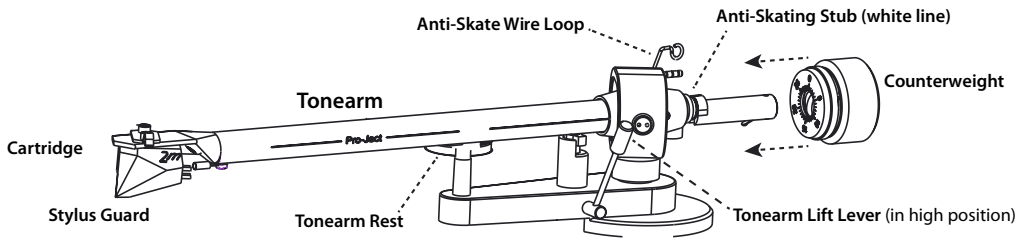

STEP 4 - Balance the Tonearm

- Install the counterweight by pushing it carefully onto the rear of the tonearm until the threaded section clicks lightly into place.
- Remove the stylus guard from the cartridge.
- With the tonearm lift lever in the lowered position, move the tonearm from its rest to a position where it can move freely.
- Rotate the counterweight until the tonearm tube balances such that it floats level.
- Once the tonearm is correctly balanced, return it to the tonearm rest position.

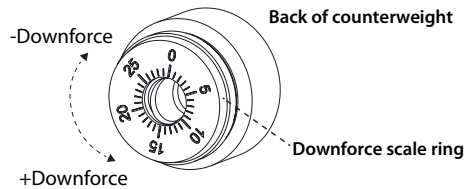

STEP 5 - Set the Tracking Force

- Use one hand to hold the counterweight in position to keep it from moving.
- Use your other hand to gently revolve the downforce scale ring until the zero (0mg) is vertical at the 12 o'clock position.
- Next, rotate the counterweight and downforce scale ring together as one, counter-clockwise (as seen from the front) to adjust the downforce according to the cartridge manufacturer's recommendations using the numbers on the downforce scale ring.
- Set the counterweight scale to 18mN (1.8g) for the supplied Ortofon 2M Silver.

STEP 6 - Set the Anti Skate force

- Carefully hang the anti-skate weight over the wire loop and attach the string to the appropriate groove on the anti-skating stub.
- For the supplied 2M silver, set the string in the middle groove (Groove 2, shown in example above). Important note: If you should change to a different cartridge in the future, refer to the recommendations of the new cartridge for optimum tracking force and anti-skate setting.

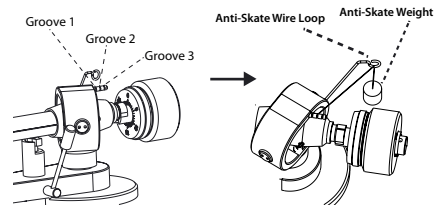

Turntable Setup Guide - cont.

STEP 7 - Install the Cover

Insert the dust cover fully into the two hinges. **Back Panel**

Input and Output Connections

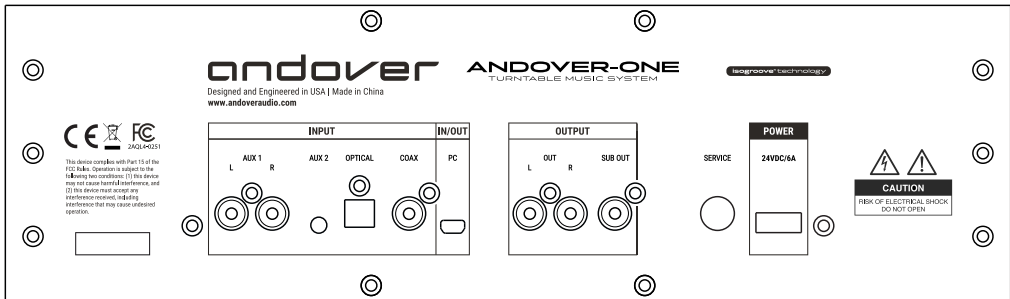

AUX 1 (RCA jack input): Connect an external audio device, such as a CD player, tape deck, or a radio Tuner.

AUX 2 IN (3.5mm analog/optical combo): Connect a WIFI streaming audio adapter such as Songbird, or any other analog or digital source. You may use an analog input with a 3.5mm stereo plug, or an optical source with a 3.5mm mini Toslink plug.

The optical portion of this input will accept up to 24Bit/96kHz input formats.

This input features optional automatic signal sensing (on the analog signal only), which will wake the Andover-One from Standby in the presence of signal. Andover-One will re-enter Standby after the absence of signal for 5 minutes. Automatic sensing can be turned on or off in the PREFERENCES menu.

DIGITAL Coax or Toslink optical input. Accepts SPDIF or PCM audio from an optical connection. The Coax input will accept up to 24Bit/192kHz input formats and the Optical input will accept up to 24Bit/96kHz.

PC (USB-Mini B): Use a USB-Mini B to USB-A cable to connect to your computer for recording or file playback. The PC interface sends and receives 44.1 or 48kHz/16 Bit

PRE-OUT (Preamp output): Outputs an unamplified analog signal to an external amplifier, a set of powered speakers.

SUB-Out (Preamp output): A monaural Preamp output for use with a subwoofer.

POWER INLET CONNECTOR: Plug the Yellow end of the supplied power adapter here. Plug the power adapter into the AC power using the cable supplied in the accessory kit.

GENERAL OPERATION

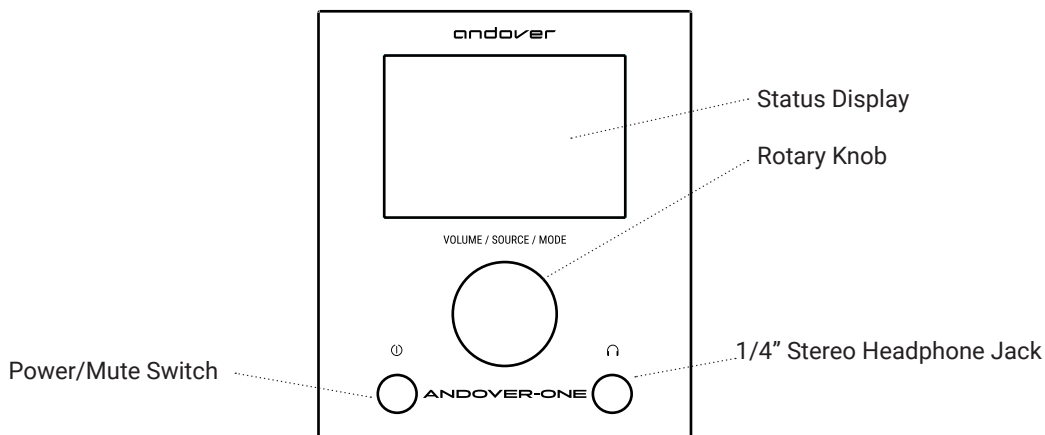

All functions of the Andover-One are selected using the menus displayed on the status display. The rotary encoder knob on the front panel is used to navigate the menu. You may also navigate by using the remote control. There are a few standardized actions that will help you understand the operation flow. Under most situations, the unit will default to the Home screen, which displays the source and mode, along with volume level from 01 to 50.

Rotating the front panel knob clockwise will increase the sound volume. Counterclockwise rotation will decrease the sound volume.

A QUICK PRESS of the knob (less than 3 sec.) will switch to the next menu, or lock in the chosen selection.

A LONG PRESS (longer than 3 sec.) when in Phono mode will pause rotation of the turntable platter and mute the audio. A subsequent press will unmute the audio and restart the platter.

A "DOUBLE CLICK" press of the knob will take you directly to the Audio Settings menu.

When you are in a menu, rotating the knob will move the selection into the highlight box. The current selection is in bold type.

- Clockwise rotation increases or moves the selection up within the menu.
- Counterclockwise decreases or moves the selection down.
- Pressing the knob will make the selection in the box.
- The adjustments of Bass, Treble, Speed Adjust, Contrast, Brightness, and Modes are effective immediately and do not require a final press to select.

Andover-One Menu Operation

HOME

The Home screen is the default that you will see at turn-on and after other menu screens time out. It shows the source playing, the selected speaker mode, and the volume level.

SELECTION

Tapping the knob brings you to the Selection screen. From here you may select a different source, and enter into the Audio Settings or System Preferences.

Rotate the knob to navigate to your selection, and tap the knob again to make the selection. If you decide to not make any changes, simply wait three seconds and the system will revert back to the Home screen. You may go back Home by selecting Back. Four choices are shown, but continue to scroll up or down to reveal the full menu.

PAUSE

Press and hold the knob for longer than 3 seconds to pause platter rotation. This makes it easier to change records. This feature is only active for the the Phono source. Tap the knob again to restart the platter.

AUDIO SETTINGS

Double-click the knob to reach the Audio Settings menu to adjust Bass and Treble, or select the listening mode. Five Listening Modes are provided. In addition to the usual MONO and STEREO modes, we have provided three PANORAMIC modes that simulate the experience of having widely spaced speakers. The suffixes L, M, and S refer to simulations of Large, Medium and Small rooms.

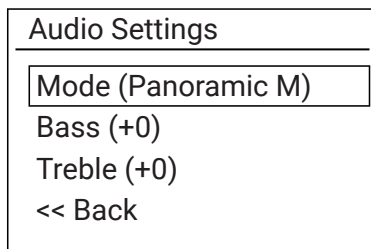
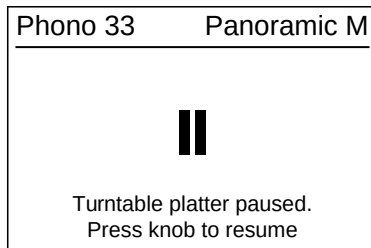
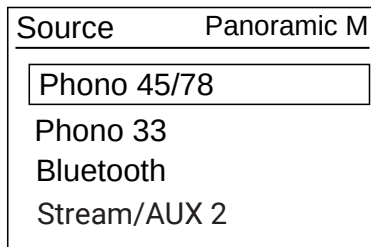
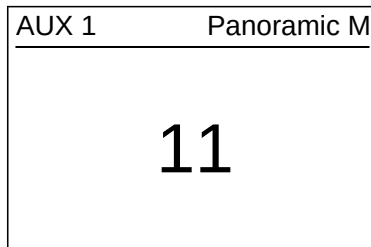

Andover-One Menu Operation (Cont.'d)

PREFERENCES

Subwoofer Output on/off – Subwoofer OFF is default. When OFF, the internal speakers receive a full range signal. When ON, a 100Hz High Pass filter reduces the bass from the internal speakers. **This should always be OFF unless a subwoofer is being used.**

Preferences
Subwoofer Output (On)
Internal Speaker (On)
Brightness
Contrast

Internal Speakers on/off – Default is ON. This enables you to turn off the internal speakers if you are using external powered speakers from the Line Out. Normally you will leave this ON.

Brightness / Contrast – These two settings control the appearance of the display and may be adjusted to your preference. The display will become dim 10 seconds after it is operated. This is intentional, and it will return to the selected brightness when any adjustments are made.

Auto On on/off – Default is ON. This enables or disables the auto-on function of Aux 2. When enabled, a signal on Aux 2 will wake Andover-One from Standby, Select Aux 2 as the input, and adjust the volume to the value set in the next line. After 5 minutes of inactivity on this input, the Andover-One will enter Standby again. Please note, if the Andover-One is being used and is not in standby, the auto-on circuit is inactive.

Auto-On Volume – This sets the volume level that you would like when the Auto On circuit wakes the Andover-One from Standby. The default value is 25.

Info – You may read the revision level of the operating Firmware, or Reset the Andover-One to the default factory values.

REMOTE CONTROL DISPLAY

When using the remote control the display format changes to an abbreviated text format with larger characters to make it easier to read from a distance. Ph33 as shown here means "Phono 33". The display will automatically revert to normal after a few seconds, or immediately if operated from the front panel.

Source	Panoramic M
Ph33	

Remote Control

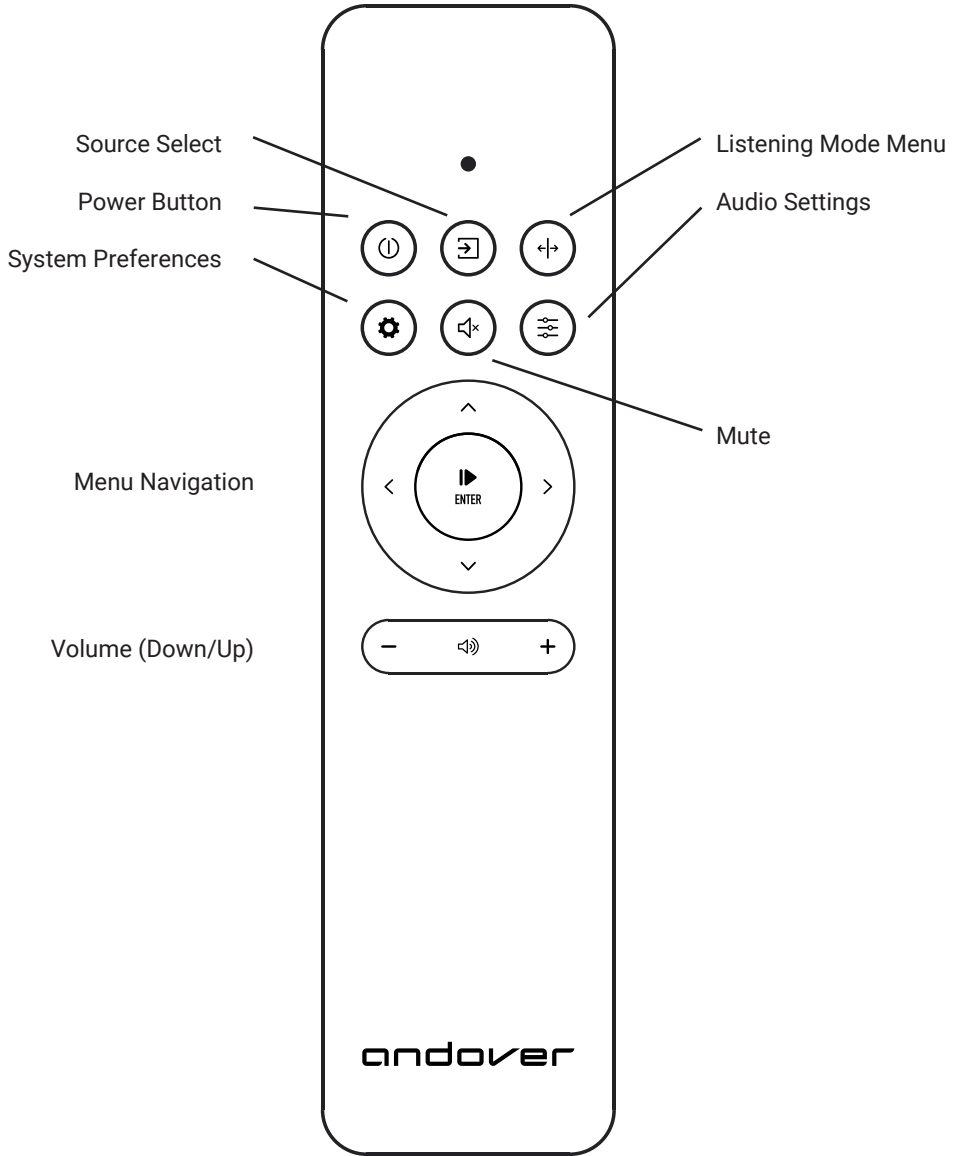

Bluetooth

To pair your device:

1. Press the central knob and select Bluetooth in the source menu.
2. Enter Bluetooth pairing mode on your device per your device's instructions.
3. Your device should soon recognize "Andover Andover-One". When recognized, select it on your device to connect.
4. Use your device to play an audio signal. Be aware that your device's volume control may still operate in addition to the volume control on Andover-One, so if you do not have adequate volume, make sure your device is turned up to a reasonable level. It is best set your device to its maximum or near maximum volume, and use the Andover-One volume to adjust your listening level.

If Andover-One does not show up on the Bluetooth screen of your device the Andover-One may be already connected to another paired device within range. You must disconnect from the undesired device before Andover-One will accept a new connection request. This must be done from that device. If you are certain this is not the case, exit Bluetooth mode and reselect it to restart the scan process.

Recording to, or playing from a Personal Computer:

You may use Andover-One to record your music to a personal computer, or play from your hard drive or streaming sites. Connect a USB-Mini B to USB-A cable from the PC jack on Andover-One to a USB jack on your PC or Mac. If your computer is using a contemporary operating system, Andover-One will not require any special drivers or software. It will emulate an external soundcard so that it may be used with any software you choose. On your personal computer, enter the SOUND menu from within your Control Panel or System Preferences. Select "USB CODEC" as the INPUT device for recording, and as the OUTPUT device for playback. You may now use built in apps such as Windows Media Player or Quicktime to record or playback from whatever source you have selected on Andover-One.

If you desire additional functionality, there is a variety of software and freeware available on the internet such as Audacity (www.audacityteam.org), which will provide features such as pop suppression, format conversion, and track splitting. You are free to use whatever software you like that is compatible with your computer's operating system.

Tips on Record Care

Unlike digital and solid state sources of music, turntables and vinyl records require a gentle touch to maximize performance and longevity. Following these guidelines will result in years of noise-free, reliable performance.

- Do not handle records by the grooved areas. Grasp them by the edges, or by balancing the label on your thumb and steadying it with your forefinger at the edge of the record. Fingerprint oils attract dust which increases wear and adds noise.
- Invest in a good record cleaning brush and use it prior to each play.
- Invest in a quality residue-free record cleaning system. Use it after every few plays or as needed.
- Always place your records back in their protective sleeves immediately after each use. Never leave them laying around unprotected.
- Always store your records vertically, and away from heat and sunlight.
- Whenever possible, use the arm lift (a.k.a. cueing lever) to gently raise and lower the stylus to the record surface.
- Clean the stylus regularly using a soft brush, or by blowing on it. Always brush from back to front. NEVER brush from side to side or front to back or the stylus will be damaged.
- Never play a record with a bent, misaligned, or damaged stylus as this can permanently damage your record.
- Always use the tracking force recommended by the stylus manufacturer. Setting the force too light can be as harmful to your valuable vinyl LP's as setting it too heavy.

Customizing your Vinyl Experience

Vinyl playback technology offers the ability to customize your experience. Various accessories are available to allow you to tune the sound and operation to your preference. Here are a few examples that may be available on www.andoveraudio.com, or from your dealer:

End of record lift: Typically, in order to eliminate resistance in tonearm motion, high quality turntables do not have automation. If you would like to add the convenience of automatic arm lift at the end of a side, the Q-Up accessory is available from Andover for use with your Andover-One. It is simple to use and has no negative effect on playback performance. It does not contact the tonearm until the arm is in the lead-out area.

Platter Mats: Changing the platter mat to a different material, or eliminating it altogether can alter the sound in subtle ways. The stock felt mat provides good performance, but some users prefer a mat of leather, cork, or other material. Different materials damp the small vibrations of the record in unique ways, depending on the material.

Delete Platter Mat: Some users opt to place their records directly on the bare acrylic platter to provide a firm interface with the vinyl record. Proponents feel this improves the bass dynamics and impact. If you choose to try this, some additional care is recommended when handling records to prevent slippage on the platter. We strongly recommend using a record damping weight or clamp to stabilize the disc. Be sure to pause the platter when changing records, and keep the platter surface clean.

Damping weight: The use of a record damping weight can help stabilize the disc and reduce undesired vibrations. The Andover Spinweight is designed to provide sufficient damping, without being too heavy, and it will not cause excessive bearing wear.

Stylus upgrades: The Ortofon cartridge that comes with your record player may be upgraded by simply replacing the stylus. The Blue, Bronze and Black styli provide improved sound and tracking ability. You may want to consider upgrading when it becomes time to change your stylus. This is the easiest way to upgrade the sound.

Playing 78 RPM records: There are two steps required to play 78 RPM records properly on your Andover-One. 78 RPM records have different groove geometry than Microgroove LP's and 45's. You must replace your 2M silver stylus with the Ortofon 2M 78 stylus. You must also remove the platter, and replace the flat belt with the round belt that came in the Andover-One accessory kit. Place this belt on the large lower pulley section. Reinstall the platter and select PHONO 45/78 as your input source. Also select MONO mode in Audio Settings.

Two-Year Warranty

Andover Audio warrants Andover-One against manufacturing defects and workmanship to the initial purchaser for a period of two (2) years from the date of delivery to customer. Andover Audio will repair or replace the unit as necessary to restore proper operation. This warranty covers both parts and labor for the warranty period. The warranty excludes physical damage caused by accident or abuse outside of our control. Or if the unit is damaged due to incorrect packing. The warranty also excludes normal wear items such as the stylus and belt. If you think you need warranty service, please contact us to obtain an RMA (Return Merchandise Authorization) by e-mailing support@andoveraudio.com or calling 978.775.3670. For more information on returns and exchanges, please visit www.andoveraudio.com/pages/returns-and-exchanges.

If your unit was purchased from a local dealer, contact them first. They may be able to resolve some issues without requiring a return.

Service

Should you encounter a problem that you are unable to solve, please contact customer service at support@andoveraudio.com, or the dealer that sold you your unit.

If you must return your unit for any reason, it must be safely packed and shipped in its original carton and packing material. Damage that is the result of improper packaging is not covered by the warranty.

Fit the cartridge protection cap and the transport lock-tie for the tonearm tube, prior to carefully packaging your unit.

Product Cleaning

Use a soft dry cloth, or compressed air. Natural wood surfaces may be conditioned using a quality wood surface cleaner and finishing oil.

Do not use harsh or chlorine based cleaner anywhere on the product. Only clean the exterior of the product. Fine dust cover scratches can be polished out with a mild abrasive compound such as toothpaste or automotive headlight cleaner and microfiber cloth.

Specifications

Description: Integrated music system with Turntable.

Music Power: 200W total (2 x 70W to woofers + 2 x 30W to tweeters)

Acoustic Frequency range: 55Hz – 30kHz +/- 3dB (under laboratory conditions)

Turntable:

Motor: 24-pole AC Synchronous motor driven by digitally synthesized 2-speed electronic speed control

Platter: 12" Acrylic with felt mat

Speeds: 33.33/45/78 RPM. Adjustable +/-3%

Wow and Flutter: <.2%

Drive system: belt

Tonearm: One piece Carbon Fiber. 8.6"

Phono Cartridge: Ortofon 2m Silver

Optical Input: Toslink SPDIF up to 24Bit/96kHz.

Coaxial Digital Input: Up to 24Bit/192kHz.

PC USB Input/Output: 44.1kHz/48kHz 16-bit. Mac and PC compatible, no driver required.

Headphone Output: 150mW @ 16 Ohms. Compatible with 16-10k Ohm headphones. Frequency Response: 20Hz–20kHz

Line Output: 1000mV, variable with volume control. 100Hz High Pass Filter @24dB per octave when SUBWOOFER ON is selected in menu.

Subwoofer Output: 1000mV, variable with volume control. 200Hz Low Pass Filter @12dB per octave.

Power Consumption: 24VDC / 6A (<0.5W Standby current)

Weight: 15.9 kg / 35 lbs

Shipping Weight: 18.6kg / 41 lbs

Dimensions:

Height: 215mm / 8.5"

Width: 446mm / 18" W

Depth: 356mm / 13.5" D

Andover Audio, L.L.C.
15 High Street North Andover, Massachusetts 01845
www.andoveraudio.com | support@andoveraudio.com

Andover is a registered trademark of Andover Audio L.L.C.
PRO-JECT is a registered trademark of AUDIO TUNING Vertriebs GmbH.
ORTOFON is a registered trademark of ORTOFON S/A.

Andover Audio subscribes to a program of continuous improvement. As a result, some product features and characteristics may change without prior notice.

1117RF