



PERISTALTIC METERING PUMPS



MODELS: VSP & FSP

OPERATING MANUAL

TABLE OF CONTENTS

1.0 SAFETY	2
2.0 SPECIFICATIONS	2
3.0 INSTALLATION	3
4.0 OPERATION	4
4.1 Controls	4
4.2 Adjusting Flow Output	4
4.3 Remote Operation	4
5.0 MAINTENANCE	6
5.1 Routine Inspection	6
5.2 Tube Replacement	6
5.3 Pumphead Maintenance	7
5.4 Fuse Replacement	7
6.0 TROUBLESHOOTING	8
7.0 REPLACEMENT PARTS	8
8.0 LIMITED WARRANTY	9
9.0 RETURNS & REPAIRS	9

1.0 SAFETY

- ⚠ WARNING:** Failure to follow the instructions in this manual may result in serious injury or death.
- ⚠ WARNING:** Risk of electric shock. This pump has been rated for indoor use only.
- ⚠ WARNING:** Risk of electric shock. Connect only to a grounding type receptacle protected by a ground-fault circuit interrupter (GFCI). Contact qualified electrician if you cannot verify that the receptacle is protected by a GFCI and that your installation meets local electrical codes.
- ⚠ WARNING:** Risk of electrical shock. Always make sure the voltage on the pump data plate matches the installation voltage before plugging the pump into a wall outlet or hooking up to an electrical supply.
- ⚠ WARNING:** Risk of electrical shock. Always disconnect the power to the pump prior to conducting and maintenance or repairs.
- ⚠ WARNING:** Risk of chemical exposure. Always wear protective clothing, including gloves and safety eye protection, when working on or near this pump.
- ⚠ WARNING:** Risk of chemical exposure. Always depressurize system and drain chemicals prior to installation or maintenance.
- ⚠ WARNING:** Risk of fire or explosion. Do not pump flammable liquids.
- ⚠ WARNING:** Risk of injury. Severe pinching of fingers can occur while installing and removing the tubing. Caution must be used to keep fingers away from rotating parts.

2.0 SPECIFICATIONS

General Specifications

Pump Head	A302
Speed Adjustment (Variable Speed Models)	5% to 100%
Run Time Adjustment (Cycle Timer Models)	0% to 100%
Motor Type	Brushless DC
Duty Cycle	Continuous
Tubing Accepted	Anko Premium Class
Tubing Bores Accepted	1/4", 3/16" & 1/8"
Operating Voltage	100-240 50/60Hz
Plug Type	NEMA 5-15P
Max Working Pressure	25 psi
Compliance	UL778; FCC Part 15b Class A

Materials of Construction

Enclosure	Polypropylene
Pump Head	Polycarbonate
Rollers	Nylon
Rotor	Zinc plated CRS

Dimensions

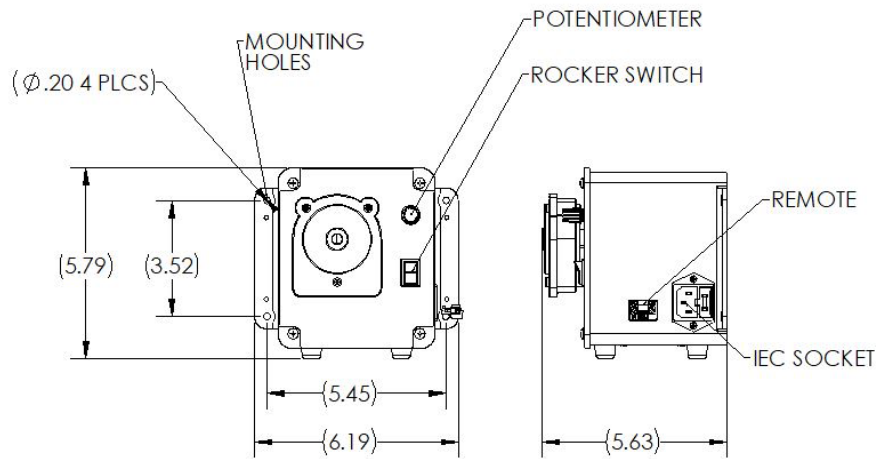

3.0 INSTALLATION

- When facing the pump, the roller assembly spins in a clockwise direction. The inlet (suction) side is located on the left side of the pumphead, and the outlet (discharge) is located on the right.
- Mount the pump in a level, dry location close to the injection point. To minimize backpressure on the system, keep the discharge tubing as short as possible.
- The recommended location is above the height of the solution tank. Mounting the pump lower than the solution tank will gravity feed the solution and create a “flooded suction” installation. In this scenario, a shut-off valve or other device must be installed to stop the solution flow to the pump during pump servicing.
- In installations involving pressure, a check valve should be used at the point of injection to prevent potential backflow.
- DO NOT mount pump directly over an open solution tank as chemical fumes may damage the pump.
- Voltage and frequency of power supply must be the same as shown on unit specification label.
- AC power must be connected to a Grounded Power Outlet (Ground Fault Circuit Interrupter GFCI). DO NOT operate pump on an un-grounded circuit.
- Ambient air temperature should not exceed 104° F (40° C) and adequate air flow should be provided.

4.0 OPERATION

⚠ WARNING: Tube failure may result in fluid being sprayed from pump. Use appropriate measures to protect operator and equipment. Tubing should be inspected periodically for tears, cracks, cuts, or abrasions.

⚠ WARNING! Use only factory approved tubing from the designated tubing class. Incorrect tubing can adversely affect performance or damage the pump.

4.1 Controls

All pumps are equipped with a rocker switch mounted on the front of the pump. Always confirm the switch is in the designated Off position before plugging the pump into any power receptacle.

2-Way Rocker - For units equipped with a two-way rocker, the up position is On, and the down position is Off.

3-Way Rocker - For units equipped with a 3-way rocker, up is On, center is Off, and the down position is either External mode, or Run mode, depending on the pump model.

Potentiometer - Variable speed models are equipped with a single turn potentiometer on the front of the pump which regulates the speed. Cycle timed models are equipped with a 10-turn potentiometer allowing for precision control of run time setting.

4.2 Adjusting Flow Output

Fixed Speed Models - There is no flow output adjustment.

Variable Speed Models - Flow output is controlled by motor speed utilizing the potentiometer. Rates are adjustable from approximately 5% to 100%. If equipped with a 4-20mA control option, pump speed will vary as the dedicated input signal changes amplitude. Please refer to Remote Operation below for more details on 4-20mA operation.

Cycle Timer Models - Cycle time is defined as the sum of the on time plus off time. On time is set by the position of the potentiometer and can be incremented up to the model's maximum total cycle time. When the 3-way rocker switch is in the down position (Run Mode), the pump will dispense for the selected time, remain off for the balance of the total cycle time, and then repeat the on cycle indefinitely until the pump is powered off or switched out of the Run Mode.

4.3 Remote Operation

Remote Start/Stop - For pump models equipped with remote start/stop, this feature operates by receiving a dry contact signal and is intended to be connected to a dry contact switch. The input has no polarity. No voltage is permitted on the input signal. The pump will activate and run while the switch is closed and deactivate and stop when the switch opens.

To activate this feature, install the pair of wires from the dry contact switch closure device into the terminal block (Figure 1). Set the 3-way rocker in the down position to place the pump in External mode. The pump will now operate only when receiving a closed contact signal. To return to local control, move the rocker switch to the up, Internal mode, position.



Figure 1

4.3 Remote Operation (Cont.)

4-20mA Control – For models equipped with a 4-20mA feature, the pump’s output will vary according to the level of an incoming 4-20mA analog signal. The pump’s maximum output to the signal is scalable between 20% and 100%, as determined by the percentage setting on the potentiometer.

For *standard signal models*, the minimum output is approximately 5.0% at 4.8mA and increases in 1.0% increments for every .16mA until 100% of the scaled output (based upon the potentiometer setting) is reached at 20.0mA (Figure 2).

For *inverted signal models*, the maximum output (as established by the potentiometer setting) is reached at 4.8mA and *decreases*, as above, until reaching zero output at 20.0mA (Figure 3).

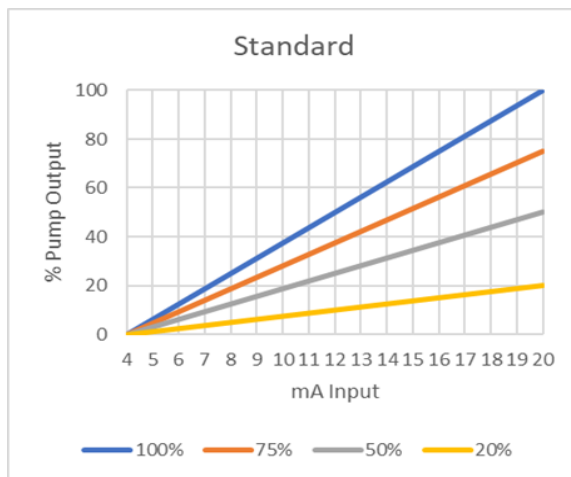

Figure 3

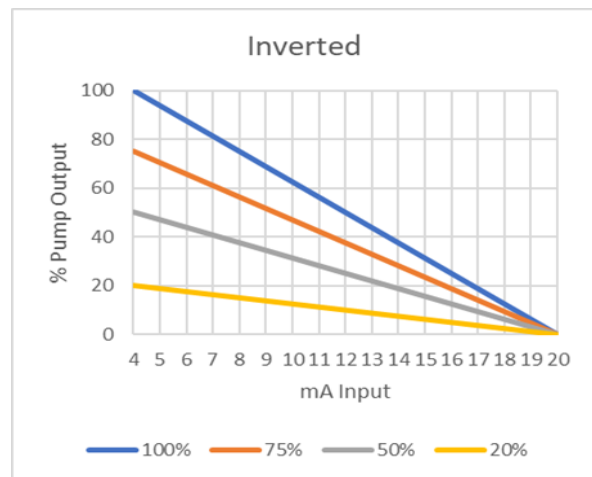

Figure 3

NOTE: Loop voltage for all models may not exceed 36VDC.

To establish and operate the analog control feature:

1. Install the two-wire lead (right side of terminal is positive; left is negative) from the 4-20mA source into the terminal block (Figure 4).
2. Set the potentiometer to the desired scaling percentage. To operate without scaling, set the potentiometer to 100%.
3. Set the 3-way rocker in the down position to enter External mode. The pump will now operate only when receiving the analog signal. While in External mode, the pump can be turned off by setting the potentiometer to 0%.

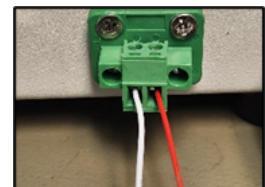

Figure 4

To return the pump manual control, place the rocker switch to the up, Internal mode, position.

5.0 MAINTENANCE

5.1 Routine Inspection

The pump should be inspected on a weekly basis. Inspect for any signs of leaking and early indications of potential tube failure (e.g., swelling, cracking or discoloration). Replace any worn or damaged components immediately. Always check the chemical compatibility and pressure rating of the tubing prior to its use.

5.2 Replacing the Tubing

Pump tubing must be replaced on a regular basis. While replacement within 500 hours of run time is recommended, tube longevity is ultimately determined by many factors, including tube formulation, the chemical composition of the fluid being pumped, system back pressure, pump speed, temperature, and more. *Use only factory designated tubing. Incorrect tubing can adversely affect performance or damage the pump.*

 **WARNING!** *Tubing connections may be under pressure. Always depressurize the system prior to connecting or disconnecting the pump.*

 **WARNING!** *Tubing may contain chemicals. Wear protective clothing, gloves and safety glasses when working with or near the pump.*

 **WARNING!** *Severe pinching of fingers can occur while installing and removing the tubing. Caution must be used to keep fingers away from rotating parts.*

Tubing Removal

When facing the pump, the roller assembly spins in a clockwise direction. The inlet (suction) side is located on the left side of the pumphead, and the outlet (discharge) is located on the right.

1. Disconnect any suction and discharge tubes from the pump tube.
2. Remove the pumphead cover.
3. With the pump running, pull the inlet (left) side of the tubing out of the pumphead channel. Carefully guide the tube clockwise away from the rollers and pull the tube out of the pumphead.

Tubing Installation

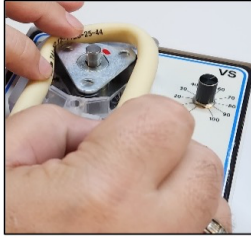

Figure 5

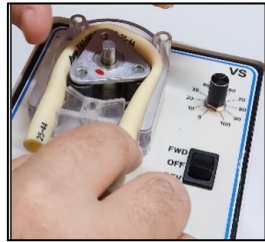

Figure 6



Figure 7

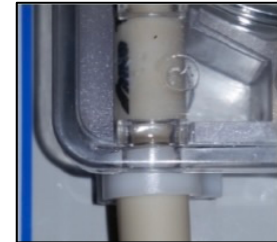

Figure 8

Start with a section of tubing at least 9" in length. Once installed, this length will result in approximately 1 1/2" extending below both sides of the pumphead for fittings and attachments.

1. With the pump running, insert tube into the channel of the inlet (suction) of pumphead (Figure 5).
2. Carefully guide the tube into pumphead and through the channel of the outlet (discharge) side of the pump head and then stop the pump (Figure 6).
3. Reinstall the pumphead cover (Figure 7).
4. Attach retention clip on the inlet (left) side of the tube just below the base of the pumphead, to prevent tube migration during operation (Figure 8).

5.3 Pumphead Maintenance

1. Remove tubing per the Tubing Removal procedure.
2. Disconnect power to the pump.
3. Remove the pumphead cover.
4. Slide roller assembly off motor shaft. For two roller configurations, first open the spring clip to release it from the motor shaft (Figure 9).
5. Remove roller assembly by sliding it off the motor shaft.

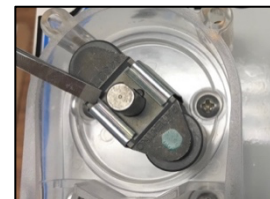

Figure 9

Once disassembled, remove any particles or debris from the pumphead housing and roller assembly. Inspect the pumphead for cracks or other damage. Ensure rollers turn freely. Be sure all cleaning solvents are removed prior to reassembly and tube replacement.

5.4 Fuse Replacement



Figure 10

1. Disconnect power to pump.
2. Slide out the fuse tray from the IEC socket (Figure 10).
3. Replace with one of identical size & Amperage rating.
4. Slide fuse tray back in to lock.

6.0 TROUBLESHOOTING

PROBLEM	POSSIBLE CAUSE	SOLUTION
Fluid Leaking	Pump tube worn	Replace tubing
	Excessive back pressure	Ensure system pressure does not exceed tube pressure rating
	Tube connections are not tight	Ensure tubing connections are properly connected
Tube Life is Shortened	Non-compatible tubing used	Use specified tubing
	Seized rollers caused abrasion on tube	Clean roller assembly or replace
	Fluid is not compatible with tubing	Use chemically compatible tubing
Pump will not start	Blown fuse	Replace Fuse
	Outlet is not powered	Verify that the unit is plugged into functioning outlet
	IEC plug has a loose connection	Verify the power cord is firmly attached to IEC receptacle
	Gearbox assembly is worn	Replace unit
Unit is ON but pump will not turn	Non-compatible tubing used	Use specified tubing
	Gearbox assembly worn	Replace unit
Pump runs but does not meet rated flow	Tubing is worn	Replace tubing
	Non-compatible tubing used	Use specified tubing
	Fluid viscosity is too high	Lower viscosity, use larger bore tubing
	Pump height is too high	Reduce pumping height

7.0 PARTS & ACCESSORIES

Please visit our website www.ankoproducts.com for factory authorized tubing, pumphead components and pump accessories.

8.0 LIMITED WARRANTY

Anko Products, Inc, (“ANKO”) warrants, subject to the conditions and exceptions herein, to replace or repair free of charge, any of its products which fail within three years of the date of manufacture. Any failure must be a result of a defect in material workmanship and not because of normal operation as described in the product user manual.

This warranty is limited to repairing or replacing any device or part of any device which is returned, transportation prepaid, to the factory and is proven to be defective upon our examination. The warranty shall not apply to repairs required for normal wear and tear, lack of reasonable and proper maintenance, chemical attack, electrical surge, or products that have been misused in our sole judgment. All consumable items such as tubing, and pump head rollers are excluded.

ANKO disclaims all liability for any loss, damage or expense directly or indirectly related to or arising from the use of its products, including damage to other products, machinery, or property. ANKO shall not be liable for any consequential damages including, without limitation, loss of profits, loss of product or loss of production. This warranty does not obligate ANKO to bear any costs of removal, installation, transportation, or other charges which may arise in connection with a warranty claim.

ANKO makes no warranties, either express or implied, other than those stated above. No representative has authority to change or modify this warranty in any respect. Jurisdiction and venue for enforcement of this warranty may be brought only in the State of Florida. This warranty gives you specific legal rights, and you may also have other rights which vary from state to state.

9.0 RETURN AND REPAIR

To return merchandise call 800-446-2656 for a Return Material Authorization (“RMA”), then, if applicable, Buyer may return the defective Products to ANKO with all costs prepaid by Buyer. ANKO will incur shipping costs for warranty products shipped from our factory. All replaced parts shall become the property of ANKO. No repair or replacement will extend the original warranty period.
FOR YOUR RECORDS:

Model _____

Date of Installation _____

Anko Products, Inc.
6012 33rd St. East, Bradenton, Florida, USA 34203
Phone: 941-749-1960 **Fax:** 941-748-2307
URL: www.ankoproducts.com

© 2023 Anko Products Inc. All rights reserved. All trademarks are the property of Anko Products, Inc. and its subsidiaries. Specifications, terms, and pricing are subject to change. Not all products are available in all countries. Please consult your local sales representative for details.