

1 | Overview

The B426 Ethernet Communication Module is a four-wire powered SDI, SDI2, or option bus device that provides two-way communication with compatible control panels over IPv4 or IPv6 Ethernet networks. The B426 on-board switch determines the bus address of the device. Configuration of the B426 is performed through the B426 configuration web pages. On SDI2 control panels, configuration can also be done on the keypad or through Remote Programming Software (RPS).

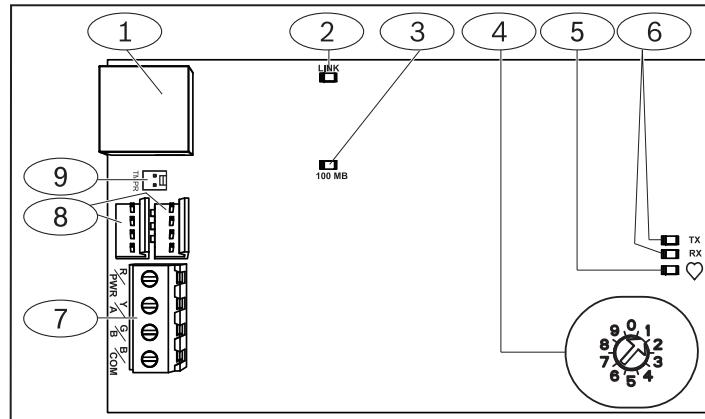

Figure 1.1: Board overview

Callout – Description
1 – Ethernet RJ-45 port
2 – Yellow LINK LED
3 – Green 100MB LED
4 – Address switch
5 – Heartbeat LED (blue)
6 – TX and RX LEDs
7 – Terminal strip (to control panel or additional modules)
8 – Interconnect wiring connectors (to control panel or additional modules)
9 – Tamper switch connector

2 | Bus address settings

One address switch determines the address for the B426 Conettix Ethernet Communication Module. The control panel uses the address for communications. Use a slotted screwdriver to set the address switch.

NOTICE! The module reads the address switch setting only during power up. If you change the switch after you apply power to the module, you must cycle the power to the module in order for the new setting to be enabled.

Set the address switch per the *Table 2.1*. If multiple B426 modules reside on the same system, each B426 module must have a unique address. *Figure 2.1* shows the address switch setting for SDI2 bus address 1.

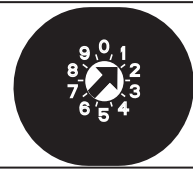

Figure 2.1: Address switch

Control panels	Switch position	Control panel address	Bus type	Function
B9512G/ B8512G, B6512/B5512/ B4512/B3512, GV4, Solution 2000/3000	1	1	SDI2	Automation, Remote Programming, or Reporting
B9512G/ B8512G, GV4, Solution, 2000/3000	2	2		
GV4, GV3, GV2, D9412G/ D7412G/ D7212G v6.3 or higher	3	80	SDI	Automation
	4	88		Remote programming or Reporting
GV4 and GV3	5	92		
FPD-7024 v1.06+, DS7240V2, DS7220V2, Easy Series, V3+, CMS Series, AMAX Series	6	134	Option	
DS7400Xi	7	13		Reporting
DS7400Xi	8	14		
FPD-7024, CMS Series, AMAX Series	9	250		Remote programming or Reporting

Table 2.1: Address switch settings

3 | Installation

After you set the address switch for the proper address, install the module in the enclosure, and then wire it to the control panel and other devices.

Caution! Remove all power (AC and battery) before making any connections. Failure to do so might result in personal injury and/or equipment damage.

3.1 | Mount the module in the enclosure

Mount the module into the enclosure's 3-hole mounting pattern using the supplied mounting screws and mounting bracket. Refer to *Figure 3.1*.

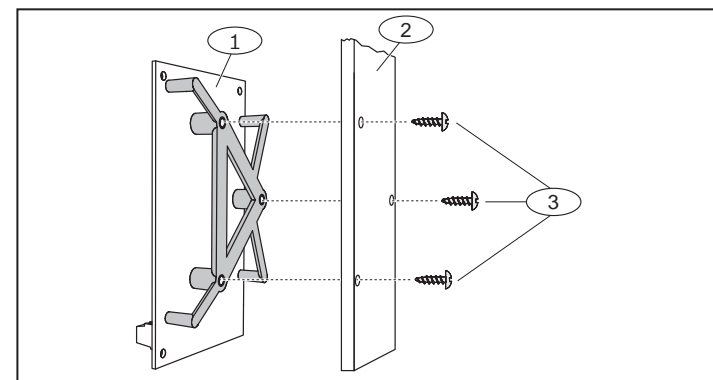

Figure 3.1: Mounting the module in the enclosure

Callout – Description
1 – Module with mounting bracket installed
2 – Enclosure
3 – Mounting screws (3)

3.2 | Mount and wire the tamper switch

For instructions on this optional switch (on GV4 Series and B Series v2.xx control panels), refer to the *Conettix Ethernet Communication Module (B426) Installation and Operation Guide* (P/N: F01U266226) and the *EZTS Cover and Wall Tamper Switch Installation Guide* (P/N: F01U003734).

3.3 | Wire to the control panel

When you wire a B426 to an SDI or SDI2 control panel, you can use either the module's terminal strip labeled R, Y, G, B (PWR, A, B, COM) or the module's interconnect wiring connectors (wire included). *Figure 1.1* indicates the location of both the terminal strip and the interconnect connectors on the module. Run the wires from the module to the data bus terminals on the compatible control panel. Refer to *Figure 3.2*.

NOTICE! Use either the terminal strip wiring **or** interconnect wiring connector to the control panel. Do not use both. When connecting multiple modules, you can combine terminal strip and interconnect wiring connectors in series.

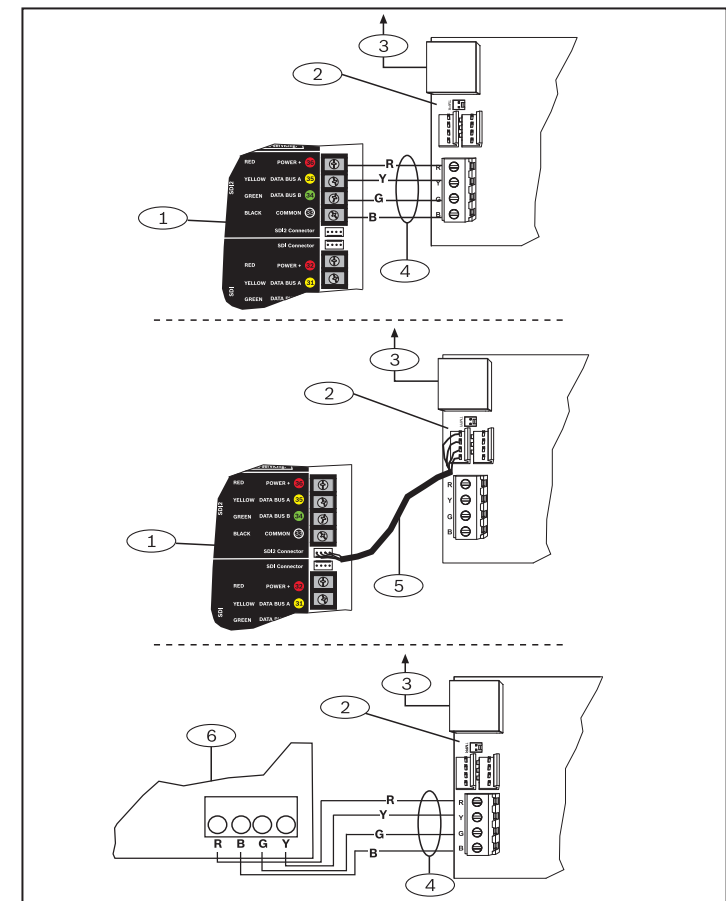

Figure 3.2: Wiring to the control panel (GV4 Series and FPD-7024 control panel shown)

Callout – Description
1 – SDI2 control panel. For SDI control panels, wire R, Y, G, B to the SDI bus.
2 – Interconnect wiring connectors
3 – To Ethernet network
4 – Terminal strip wiring
5 – Interconnect cable (P/N: F01U079745) (included)
6 – Option bus control panel

4 | Configuration

Configure the B426 using one of the methods described in this section for your control panel type.

4.1 | PnP for SDI2 or option bus control panel

NOTICE! Option bus control panels support AMAX 2100/ 3000/ 4000 firmware version v1.5 or higher only.

NOTICE! By default, when connecting a field replacement B426 to an existing SDI2 or option bus control panel, the panel overrides the module settings. To keep custom module settings when you connect a module to a configured control panel, you must disable Panel Programming using web-based configuration, prior to connecting to the SDI2 or option bus.

When connected to a non-default SDI2 or option bus control panel, the control panel automatically configures a connected module.

1. Set the address switch to the correct address for the control panel (SDI2 control panels use address 1 or 2, option control panels use addresses 134 or 250).
2. Connect the module to the control panel bus and apply power.
3. Program the control panel communication settings using RPS for SDI2 control panel, A-Link for option control panel, or the keypad.

4.2 | PnP for SDI or option bus control panels

When installing under the following conditions, the B426 needs no further configuration:

- DHCP is available on your network.
- AES encryption is not required.
- Default B426 port settings (UDP on Port 7700) are permitted by the network administrator.

4.3 | Web-based configuration

For installations requiring non-default configuration, use the B426 web-based configuration pages.

To use the B426 configuration pages, you need the module's IP address or hostname.

- The default hostname for the module is the letter B followed by the last six alpha-numeric digits of its MAC address (for example, B3F603F).
- Locate the IP address in the table on the DHCP server (networked modules).
- To use Auto IP, directly connect from your PC to the B426. Within 60 seconds, the B426 temporarily assumes address 169.254.1.1 for configuration. (Refer to the Conettix Ethernet Communication Module Installation and Operation Guide for more information on using these methods.)

NOTICE! Before proceeding, ensure that the web browser is not configured to use a proxy server. Refer to the browser's online help for instructions on disabling proxy service.

- Logging into web-based configuration (B426 Configuration Pages):
1. Open an internet browser (Microsoft Internet Explorer or Mozilla Firefox) and type in the B426's IP address. The B426's login page opens.
 2. Enter the password (the default is *B42V2*) and click Login. The Device Information home page opens.
 3. Browse to the desired settings page and configure the parameters.
 4. Click OK and then click Save & Execute to save and apply all changes to the device.

5 | LED descriptions

The B426 module includes the following on-board LEDs to assist with troubleshooting issues.



Flash pattern	Function
Flashes once every 1 sec 	Normal state: Indicates normal operation state.
3 quick flashes every 1 sec 	Communication error state: Indicates a bus communication error. The module is not receiving commands from the control panel.
On Steady 	Trouble state. Indicates a trouble condition exists.
Off 	LED trouble state. Module is not powered, or some other trouble condition prohibits the module from controlling the heartbeat LED.

Table 5.1: Heartbeat LED descriptions

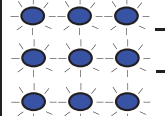

Flash pattern	Function
RX (Receive) flashes 	Occurs when the module receives a message over the network connection – UDP, TCP, or DNS.
TX (Transmit) flashes 	Occurs when the module sends a message over the network connection – UDP, TCP, or DNS.

Table 5.2: RX and TX LEDs descriptions











LINK (yellow) flash pattern	100mb (green) flash pattern	Function
Off 	Off 	No Ethernet link
On Steady 	Off 	10 BASE-T link
Flash 	Off 	10 BASE-T activity
On Steady 	On Steady 	100 BASE-T link
Flash 	On Steady 	100 BASE-T activity

Table 5.3: Ethernet LINK and 100mb LEDs descriptions











Condition	Heartbeat	Transmit (TX)	Receive (RX)
Network cable disconnected	On Steady 	Off 	1 quick flash, repeating 
Obtaining an IP address	On Steady 	Off 	2 quick flashes, repeating 
Low bus voltage	On Steady 	Off 	3 quick flashes, repeating 
Internal failure	On Steady 	On Steady 	On Steady 

Table 5.4: Trouble conditions indicated through LEDs

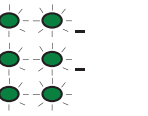
6 | Certifications

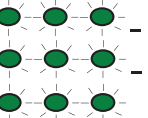
Region	Certification
USA	UL 365 – Police Station Connected Burglar Alarm Units and Systems
	UL 609 – Local Burglar Alarm Units and Systems
	UL 864 – Control Units and Accessories for Fire Alarm Systems (Including NFPA 72)
	UL 985 – Household Fire Warning System Units
	UL 1023 – Household Burglar Alarm System Units
	UL 1076 – Proprietary Burglar Alarm Units and Systems
	UL 1610 – Central Station Burglar Alarm Units
	FCC Part 15 Class B, NIST FIPS-197 AES Certification (IP Communications)
Canada	CAN/ULC S303 – Local Burglar Alarm Units and Systems
	CAN/ULC S304 – Signal Receiving Centre and Premise Alarm Control Units
	CAN/ULC S559 – Fire Signal Receiving Centres and Systems
	ULC-ORD C1023 – Household Burglar Alarm System Units
	ULC-ORD C1076 – Proprietary Burglar Alarm Units and Systems
EU	EN 50130-4, EN 61000-6-3, EN 60950
Australia	C-Tick

7 | Specifications

Dimensions	59.5 mm x 108 mm x 16 mm (2.19 in x 4.25 in x 0.629 in)
Voltage (operating)	12 VDC nominal
Current (maximum)	100 mA max
Connectors	LAN/WAN: RJ-45 modular port (Ethernet)
Ethernet cable	Category 5 or better unshielded twisted pair, 100 m (328 ft) max length
Interface	IEEE 802.3
Data bus wire size	1.02 mm to 0.65 mm (18 AWG to 22 AWG)
Data bus wire length	Maximum distance - Wire size: 150 m (500 ft) - 0.65 mm (22 AWG) 300 m (1000 ft) - 1.02 mm (18 AWG)
Web browser	Microsoft Internet Explorer; Mozilla Firefox
Compatibility	AMAX 2000/2100/3000/4000 B9512G/B9512G-E, B8512G/B8512G-E B6512, B5512/B5512E, B4512/B4512E, B3512/B3512E D9412GV4/D7412GV4/D7212GV4 D9412GV3/D7412GV3/D7212GV3 D9412GV2/D7412GV2/7212GV2 Version 7.06 or higher DS7220 Version 2.10 or higher DS7240 Version 2.10 or higher DS7400Xiv4 Version 4.10 or higher Easy Series V3+ FPD-7024 Version 1.02 or higher Solution 2000/3000

Copyright

This document is the intellectual property of Bosch Security Systems, Inc. and is protected by copyright. All rights reserved.

Trademarks

All hardware and software product names used in this document are likely to be registered trademarks and must be treated accordingly.

Bosch Security Systems, Inc. product manufacturing dates

Use the serial number located on the product label and refer to the Bosch Security Systems, Inc. website at <http://www.boschsecurity.com/datecodes/>.

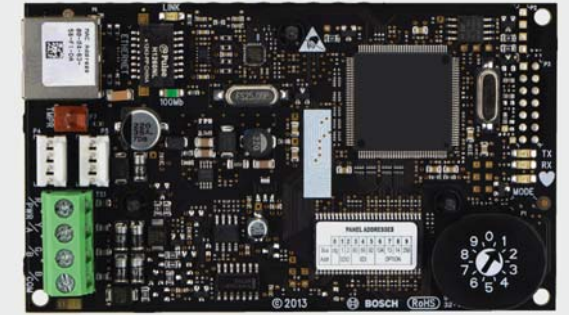

Conettix Ethernet Communication Module B426



en Quick Start Guide

For complete installation, configuration, and testing instructions, refer to the *Conettix Ethernet Communication Module (B426) Installation and Operation Guide* provided on the supplied CD-ROM.

Bosch Security Systems, Inc.

130 Perinton Parkway
Fairport, NY 14450
USA

www.boschsecurity.com

Bosch Sicherheitssysteme GmbH

Robert-Bosch-Ring 5
85630 Grasbrunn
Germany

