

- In addition to routine checks for each use, PPE should regularly undergo a detailed inspection by a competent person. Petzl recommends an inspection every 12 months and after any exceptional event in the life of the product.
 - PPE inspection should be conducted with the manufacturer's Instructions for Use.
- Download the instructions at [PETZL.COM](https://www.petzl.com).

PROFESSIONAL HARNESSSES

1. Known product history

Any PPE showing unexpected degradation should be quarantined, pending a detailed inspection.

The user should:

- Provide precise information on the usage conditions.
- Report any exceptional event regarding his/her PPE.

(Examples: fall or fall arrest, use or storage at extreme temperatures, modification outside manufacturer's facilities...).

2. Preliminary observations

Verify the presence and legibility of the serial number and the CE mark.

Note: the serial number code on our products is evolving. Two types of code will coexist. See below for details on each serial number code.

Code A:

00 000 AA 0000

Year of manufacture
Day of manufacture
Name of Inspector
Incrementation

Code B:

00 A 0000000 000

Year of manufacture
Month of manufacture
Batch number
Incrementation

Verify that the product lifetime has not been exceeded.

Compare with a new product to verify there are no modifications or missing parts.



3. Checking the condition of the straps

Check for cuts, swelling, damage and wear due to use, to heat, and to contact with chemicals. Check the waistbelt straps, leg loops, leg loop/waistbelt linkage and shoulder straps, if present. Be sure to check the areas hidden by the buckles.

- Check the condition of the safety stitching on both sides. Look for any threads that are loose, worn, or cut. The safety stitching is identified by thread of a different color than that of the webbing.

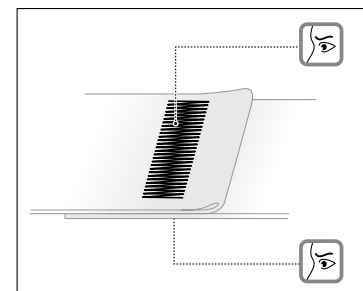
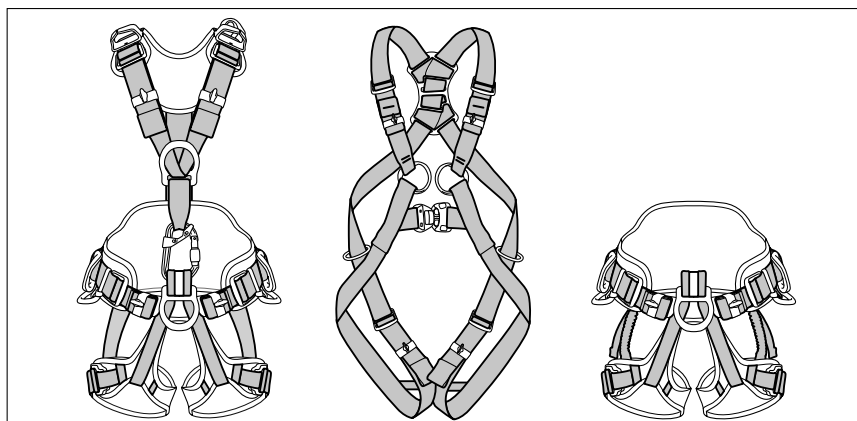

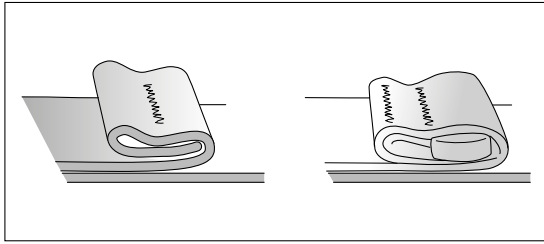

- Verify that hems are present on the strap ends.

4. Checking the attachment points

- Check the condition of the metal attachment points (marks, cracks, wear, deformation, corrosion...).

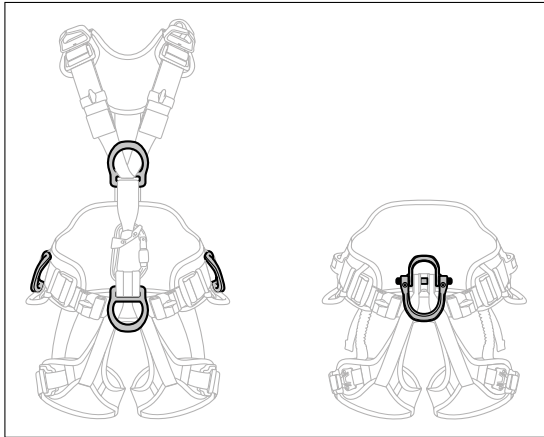

- Check the condition of the textile attachment points (cuts, wear, tears...).

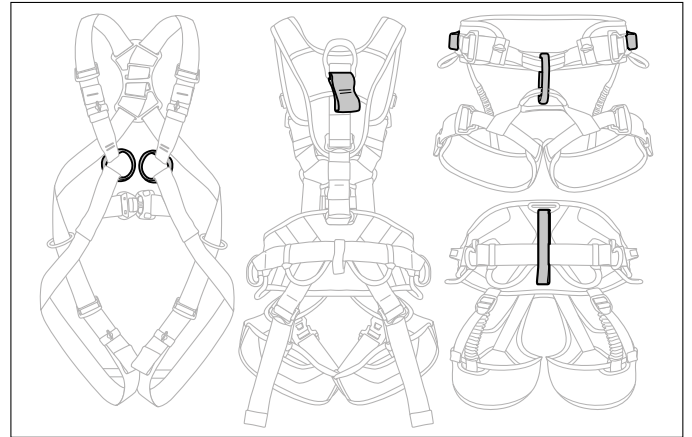

- Check the condition of the plastic attachment points (cuts, wear, tears...).

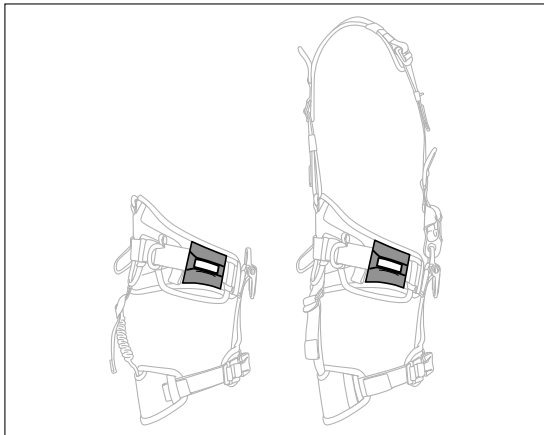

- On the multi-standard NAVAHO and AVAO harnesses, check the fall arrest indicator. The indicator shows red if the dorsal attachment point sustains a shock load greater than 400 daN.

5. Checking the condition of the adjustment buckles

- Check the condition of the DOUBLEBACK adjustment buckles (marks, cracks, wear, deformation, corrosion...).

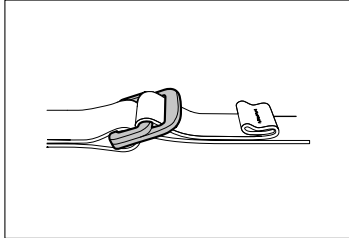

- Check the condition of the FAST adjustment buckles (marks, cracks, wear, deformation, corrosion...).

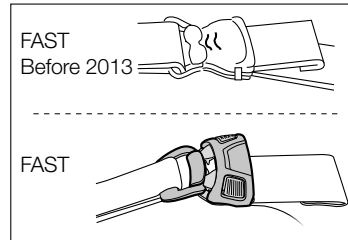

- Check that the straps are correctly threaded, with no twists.

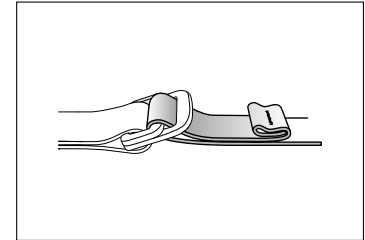

- Verify that the buckles operate properly.

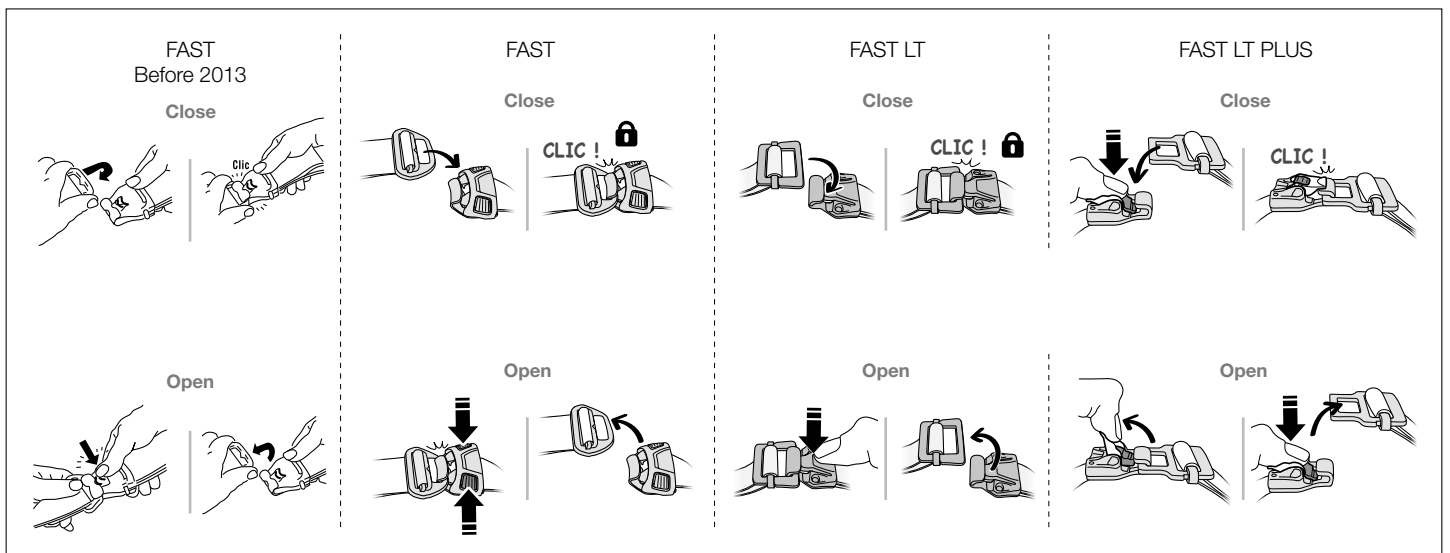
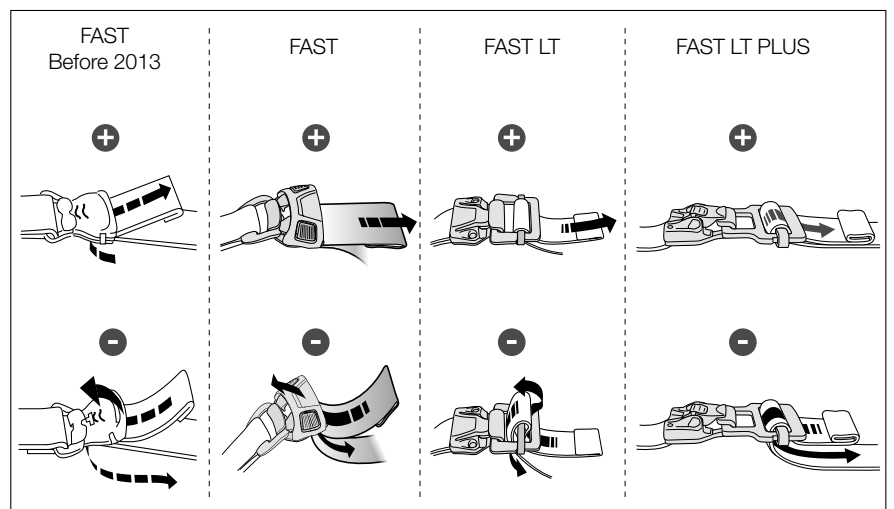
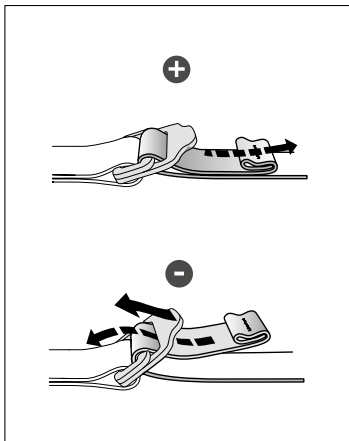

6. Checking the condition of the comfort parts

- Check the condition of the waist, leg and shoulder foams (cuts, wear, tears...).

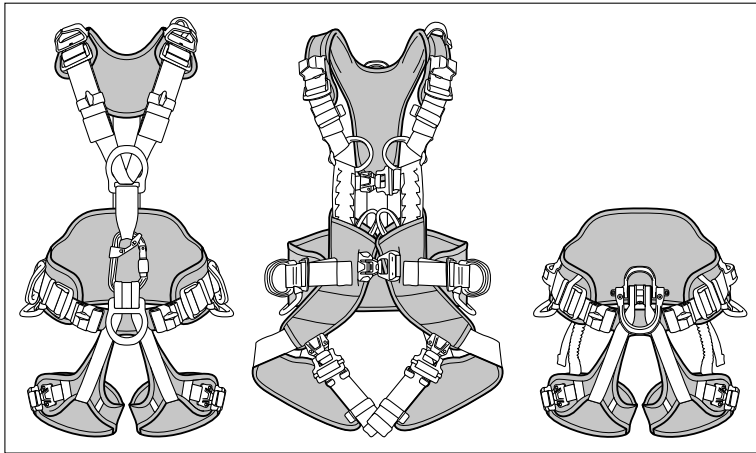

- Check the condition of the elastic and/or plastic keepers (cuts, wear, tears...).

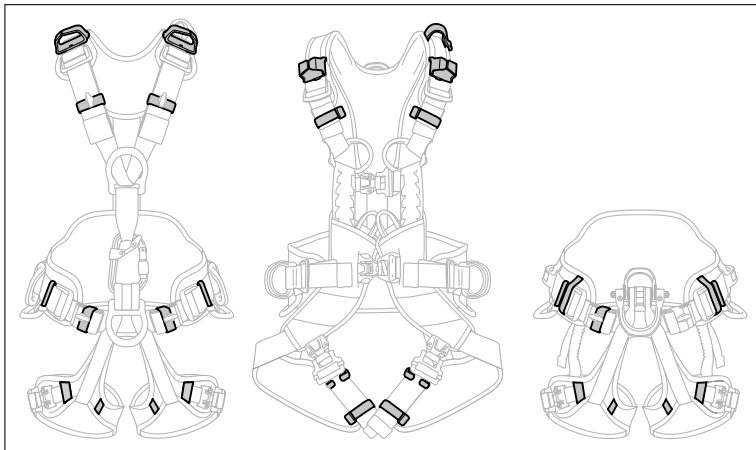

- Check the condition of the leg loop elastics (cuts, wear, tears...).

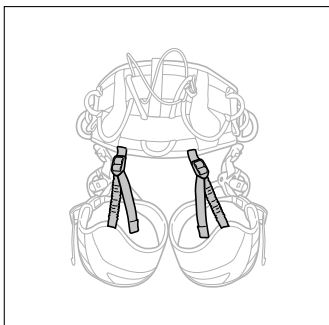

- Check the condition of the equipment loops (cuts, wear, tears...).

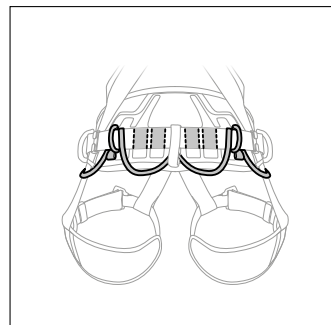

7. Checking the condition of the chest/seat harness connector (if any)

- For connector inspection, see the inspection form for your connector model at Petzl.com.

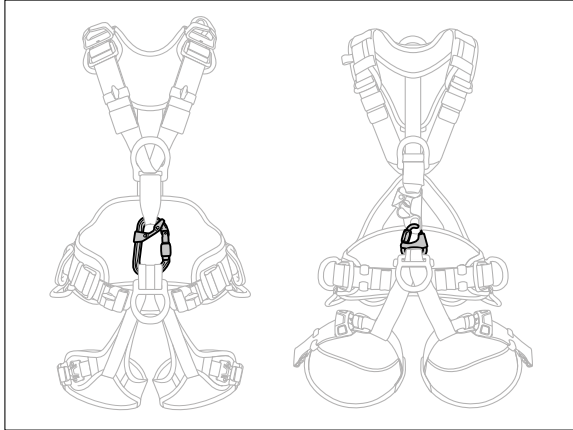

- If the harness features a chest/seat harness connector, make sure that it is present.

- Verify that the connector is the correct model and that it is correctly attached to the harness.

- Gated attachment point: verify that the screws on the gated attachment point are present and properly tightened.

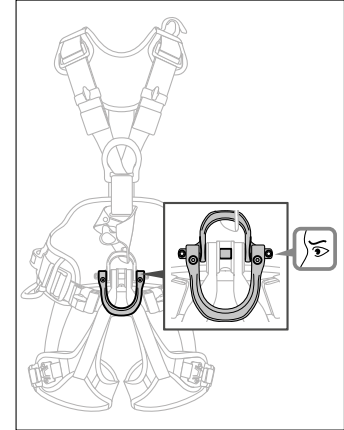

8. Checking the condition of the CROLL rope clamp (if any)

- For rope clamp inspection, see the inspection form for your rope clamp model at Petzl.com.

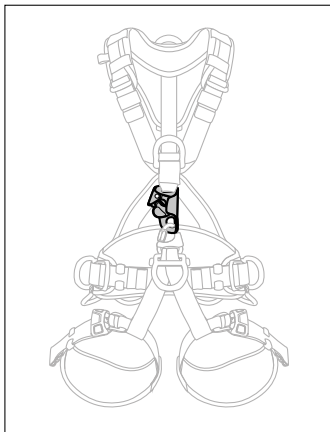

9. Special case for SEQUOIA/SEQUOIA SRT harnesses

- Check the condition of the textile attachment bridge (cuts, wear, tears...). For attachment bridges made of rope: make sure the rope has no cuts, burns, frayed strands, fuzzy areas, or signs of chemicals...

- Check the condition of the gated rings (marks, cracks, wear, deformation, corrosion...). Verify that the screw is in place and properly tightened.

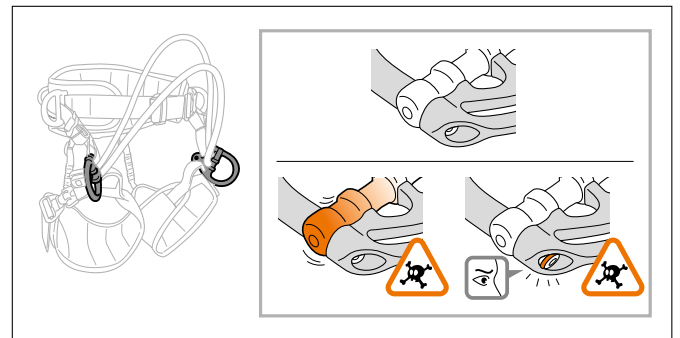
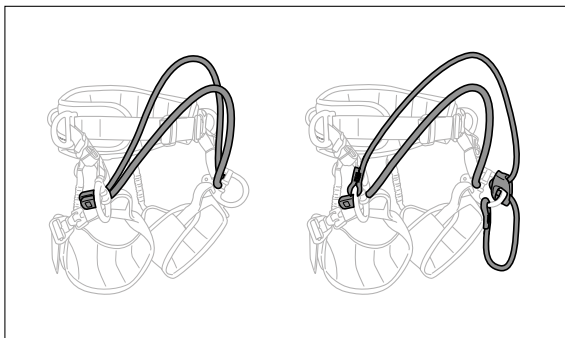
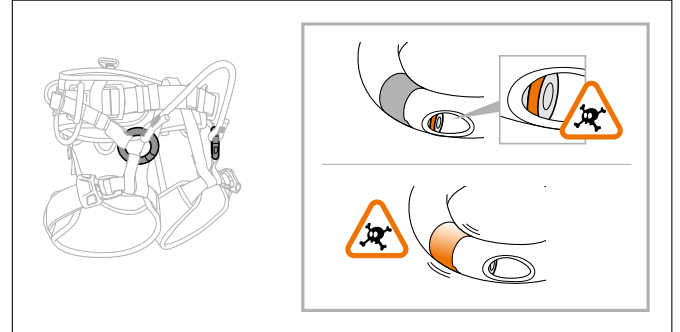
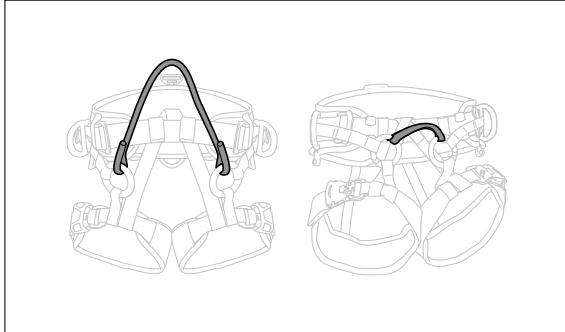

		SEQUOIA V1	SEQUOIA V2	SEQUOIA V3 (2019)
Mounting compatibility (certification not taken into account)				
Bridge v1 Strap		✓	✓	✓
Bridge v2 Rope with eye		✗	✓	✓
Bridge v3 (2019) With stop- per		✗	✗	✓
ADJUST bridge v2 and v3		✗	✓	✓

10. Special case: NEWTON HI-VIZ

- On the HI-VIZ models, check the condition of the HI-VIZ vest and of the reflective bands (cuts, wear, fading...).

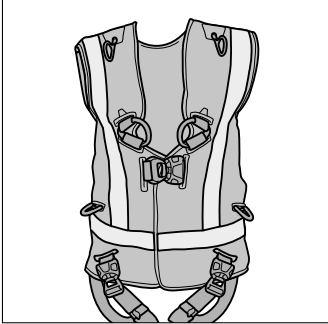

11. Appendices: examples of worn harnesses that should be retired or repaired

- Cut equipment loop



- Cut load adjustment strap



- Damaged protective fabric



- Damaged protective fabric



• Reversed bar



• Damaged webbing

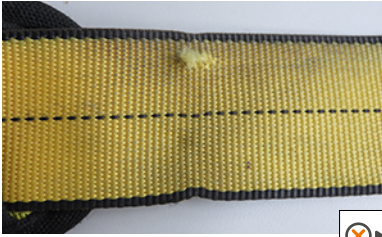

• Marking on webbing



• Cut webbing

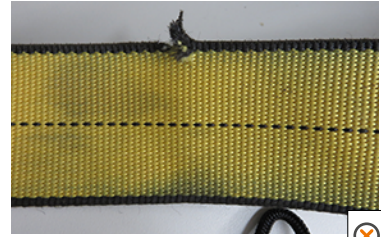

• Damaged webbing



• Damaged webbing



• Unstitched hem



• Damaged attachment point



• Fall indicator is visible



• Damaged safety stitching



• Damaged attachment point



• Damaged attachment point



• Damaged attachment point



• Worn out D-ring



• Broken buckle



• Corrosion



• Corrosion



• Traces of paint



• Buckle not working



▶ Petzl contact