

10DTDRK0806-V2
Staffordshire

BEFORE YOU START PLEASE READ INSTRUCTIONS CAREFULLY

- Check the pack and make sure you have all the parts listed.
- When you are ready to start, make sure you have the right tools at hand (not supplied) including a Phillips screwdriver, Stanley knife, Wood saw, Step ladder, Hammer and a Drill with 2mm bit.
- Ensure there is plenty of space and a clean dry area for assembly.

LOCATION FOR YOUR GARDEN BUILDING

A minimum of 60cm should be left around the perimeter of your garden building to allow access for maintenance, annual treatment and to allow air flow around the building.

Where possible you should avoid placing your garden building underneath large trees to prevent the tree causing damage to the building.

TIMBER

As with all natural materials, timber can be affected during various weather conditions. For the duration of heavy or extended periods of rain, swelling of the wood panels may occur. Warping of the wood may also occur during excessive dry spells due to an interior moisture loss. Unfortunately, these processes cannot be avoided but can be helped. It is suggested that the outdoor building is sprayed with water during extended periods of warm sunshine and sheltered as much as possible during rain or snow.

Once your garden building has been installed it will need to be treated as soon as possible and annually to prevent the timber from deteriorating and to waterproof it. This is required to maintain the anti-rot guarantee.

- Dip Treated buildings - Require a preservative treatment to protect against rot and decay and a waterproof treatment to prevent water ingress
- Pressure Treated buildings - Require a waterproof treatment to prevent water ingress
- Log Cabins - Are supplied untreated and require a preservative and waterproofing treatment.

BUILDING A BASE

When thinking about where the building and base is going to be constructed:
Ensure that there will be access to all sides for maintenance work and annual treatment.

Ensure the base is level and is built on firm ground, to prevent distortion. Refer to diagrams for the base dimensions, The base should be slightly smaller than the external measurement of the building, i.e. The cladding should overlap the base, creating a run off for water. It is also recommended that the floor be at least 25mm above the surrounding ground level to avoid flooding.

TYPES OF BASE

- Concrete 75mm laid on top of 75mm hard-core.
- Slabs laid on 50mm of sharp sand.

Whilst all products manufactured are made to the highest standards of Safety and in the case of childrens products independently tested to EN71 level, we cannot accept responsibility for your safety whilst erecting or using this product.



x2 All buildings should be erected by two adults



Winter = High Moisture = Expansion
Summer = Low Moisture = Contraction



2mm Drill bit

For ease of assembly, you **MUST** pilot drill all screw holes and ensure all screw heads are countersunk.



CAUTION

Every effort has been made during the manufacturing process to eliminate the prospect of splinters on rough surfaces of the timber. You are strongly advised to wear gloves when working with or handling rough sawn timber.



For ease of assembly, you will need a tape measure to check dimensions of components.

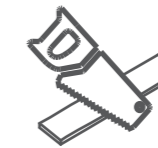

It is advisable to use a hand saw when cutting roof and floor boards.

Protim Aquatan T5 (621)

Your building has been dip treated with **Aquatan**.

Aquatan is a water-based concentrate which is diluted with water, the building has been treated by the correct application of Aquatan solution and then allowed to dry.

Aquatan is a decorative finish to colour the wood, which is applied industrially to timber fence panels and garden buildings.

Aquatan undiluted contains: boric acid, sodium hydroxide 32% solution, aqueous mixture of sodium dioctyl sulphosuccinat and alcohols: 2, 4, 6-trichlorophenol.



REGISTER FOR YOUR
ANTI-ROT
GUARANTEE TODAY

PLEASE SCAN HERE:

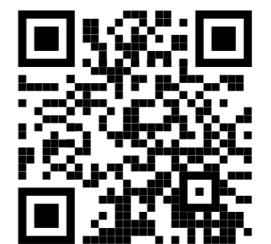

For assistance please contact customer care on: 01636 821215
Mercia Garden Products Limited,
Sutton On Trent,
Newark,
Nottinghamshire,
NG23 6QN

www.merciagardenproducts.co.uk

0806 (Pack A)

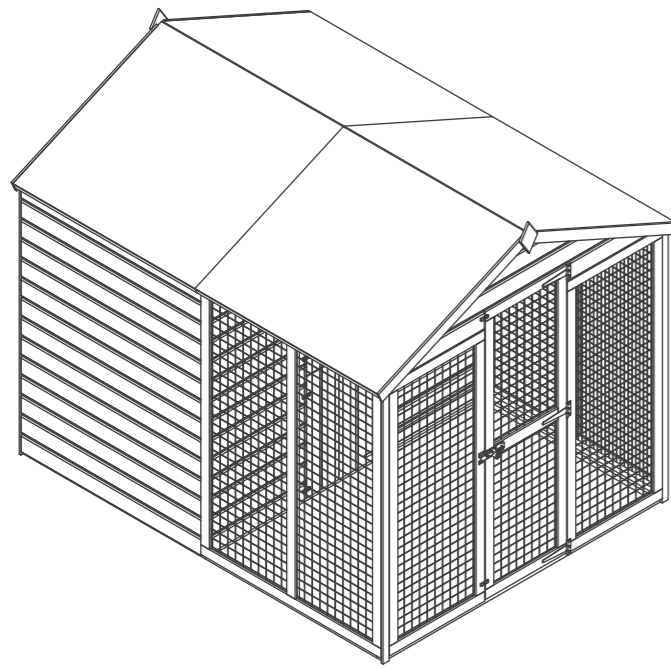

0806 (Pack B extension)

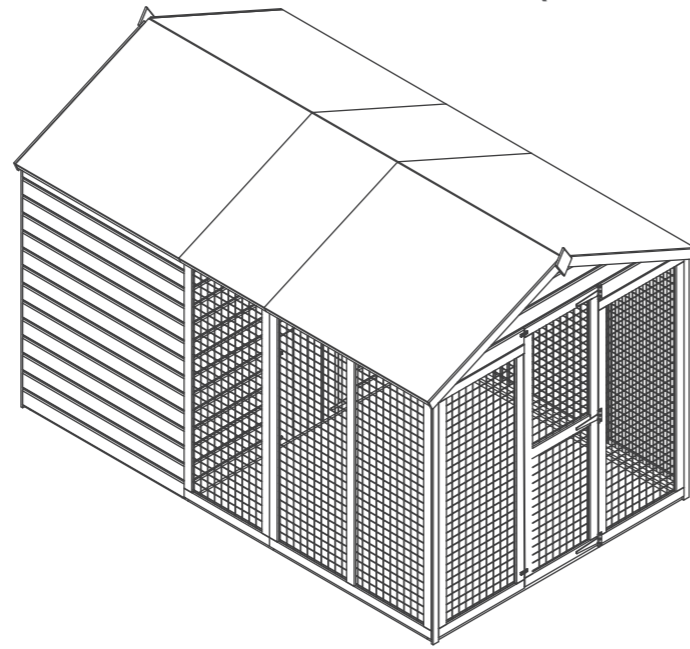

0806 Pack A
Purchased Pack component list

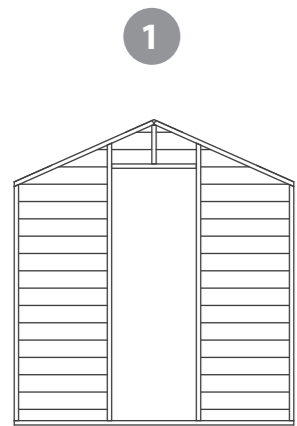

Front Panel QTY 1
AI-10DRKFDP1808x1974

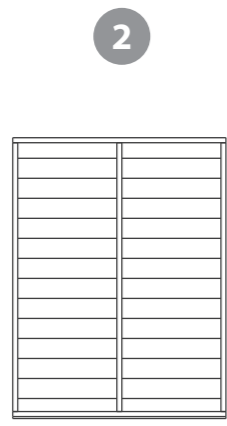

Side Panel QTY 2
AI-01COMGRNPS1193x1543

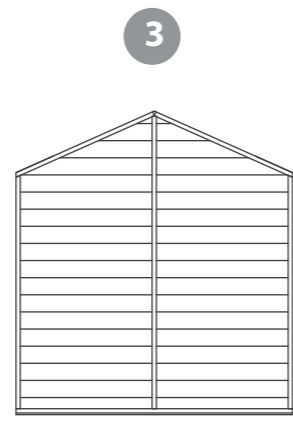

Rear Gable Panel QTY 1
AI-01COMGRNPG1808x1985

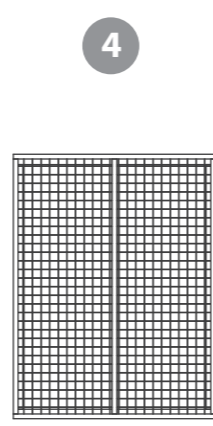

Large Side Mesh Panel QTY 2
AI-10DRKSMP1193x1560

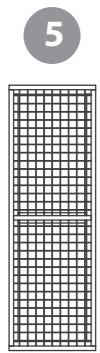

Mesh Door QTY 1
AI-10DRKMD538x1649

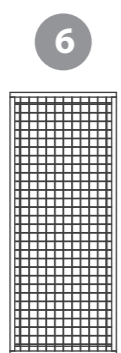

Small Side Mesh Panel QTY 2
AI-10DRKSMP630x1560

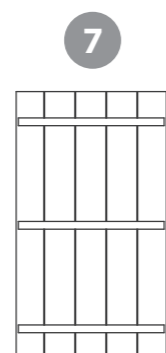

Door A QTY 1
AI-10DRKDA542x965

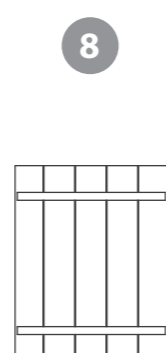

Door B QTY 1
AI-10DRKDB542x695

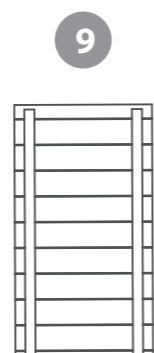

Floor QTY 3
AI-10DRKF599X1122

- 10 **Front Gable QTY 1**
AI-10DRKFG1808x417
- 11 **OSB Roof Sheet QTY 4**
PI-03-0374
- 12 **6" T-Hinge QTY 7**
PI-07-0082
- 13 **Finial QTY 2**
Shed Diamond
- 14 **L Bracket QTY 4**
PI-07-0012
- 15 **Turn Button QTY 6**
PI-07-0034
- 16 **Pad Bolt QTY 1**
PI-07-0035
- 17 **Ply Triangle QTY 2**
- 18 **Fascias - 12x60x1100mm** S1260-1100mm **x4**
- 19 **Ridge Bar - 27x70x1153mm** F2770-1153mm **x1**
- 20 **Bearer - 27x44x1119mm** F2744-1119mm **x2**
- 21 **Bearer - 27x44x1860mm** F2744-1860mm **x3**
- 22 **Ridge Bar - 27x70x1137mm** F2770-1137mm **x1**
- 23 **Eaves Frame - 28x28x1205mm** FS2828-1205mm **x4**
- 24 **Cover Trim - 12x40x1582mm** S1240-1582mm **x4**
- 25 **Bearer - 27x44x1135mm** F2744-1135mm **x2**
- 26 **Framing - 28x28x950mm** FS2828-950mm **x2**
- 27 **Door Strip - 12x27x1615mm** S1227-1615mm **x1**
- 28 **Felt**
- 29 **Capping Felt**

Image of 0806 + extension

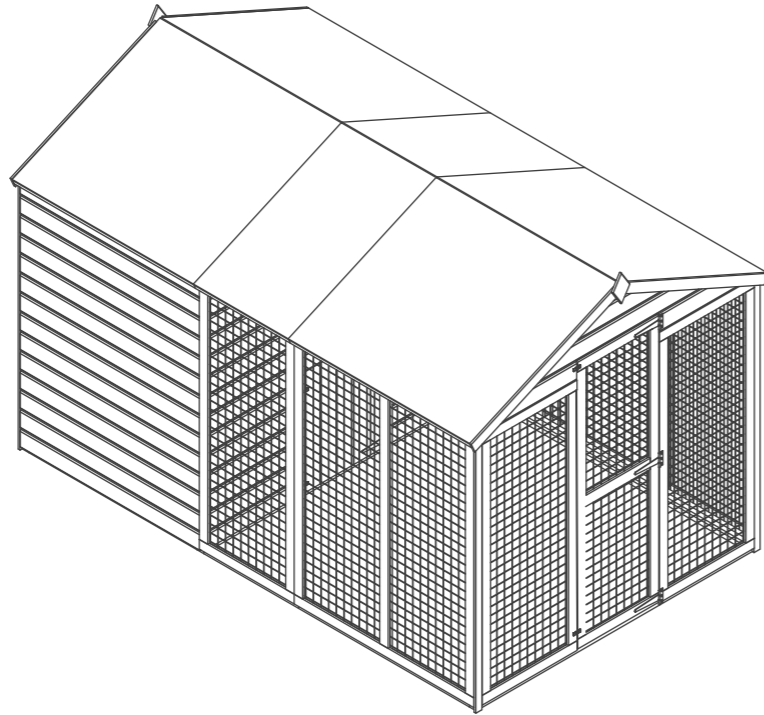

0806 -Extension Pack
Purchased Pack B parts

30

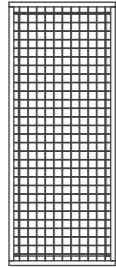

Side Mesh Panel QTY 2
AI-10DRKSMP630x1560

31

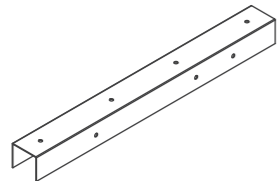

U Shaped Channel - QTY 1
PI-07-0013

32

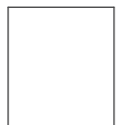

OSB Roof Sheet QTY 2
PI-03-0375

33



Ridge Bar - 27x70x630mm F2770-630mm x1

34



Truss support - 27x44x987mm F2744-G-987mm x2

35



Block - 27x44x140mm F2744-G-140mm x2

36



Truss Support - 27x44x450mm F2744-G-450mm x1

37



Bearer - 27x44x630mm F2744-630mm x2

38



Eaves Frame - 28x28x630mm FS2828-630mm x2

Nail Bag

There may be extra screws present in the nail bag

Pack A

Pack B

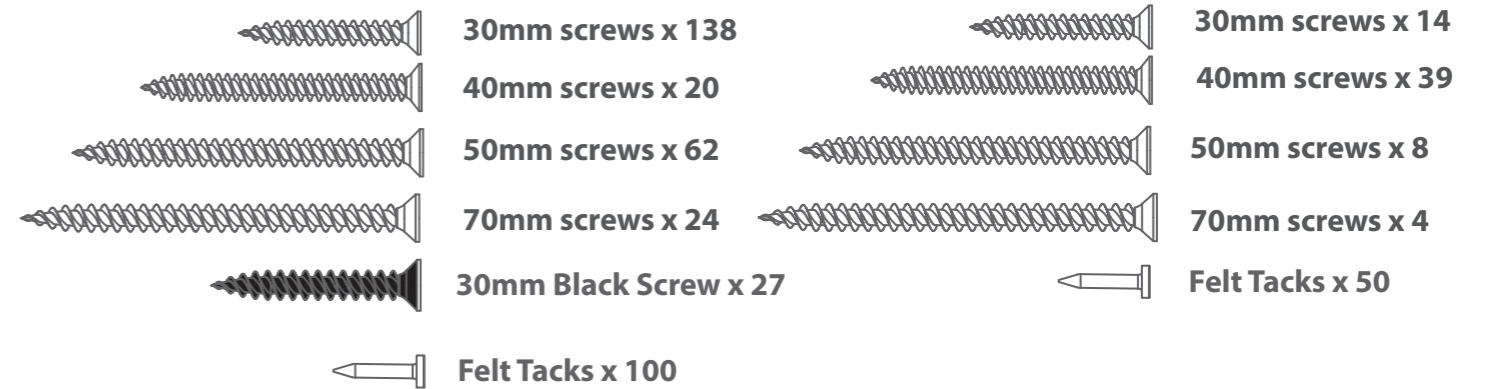

Pack B

If you have purchased multiple pack B's then you will have double the amount of each item in pack B

Step 1

Construct the base bearers using 2x (No. 20 & No. 21). This will create the base for the Dog Kennel. Ensure part 20 sits inside part 21.

Fix the framing together with 2x70mm screws per corner.

8x70mm screws.

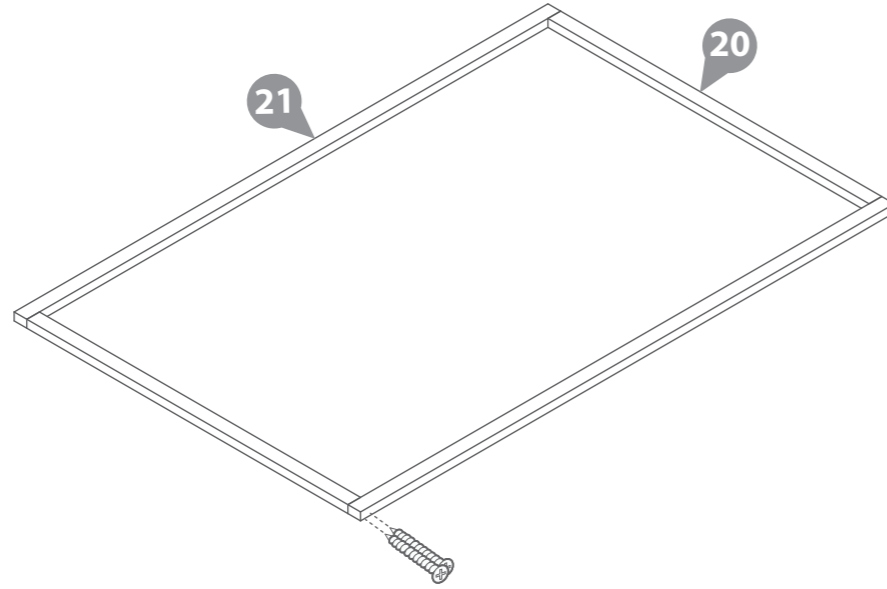

Step 2

Place the side panel (No. 2) and the rear gable Panel (No. 3) onto the base framing and fix together with 4x50mm screws.

****Do NOT fix to the base framing until the Roof is secured****

4x50mm screws.

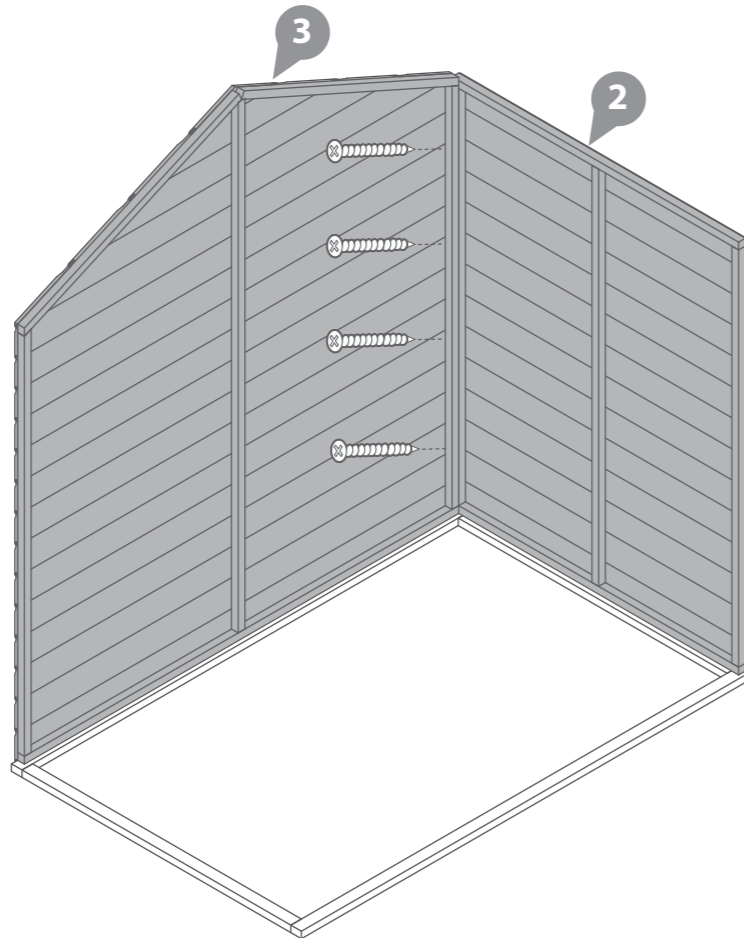

Step 3

Place the second side panel (No. 2) onto the base framing and fix together to the back panel with 4x50mm screws.

****Do NOT fix to the base framing until the Roof is secured****

4x50mm screws.

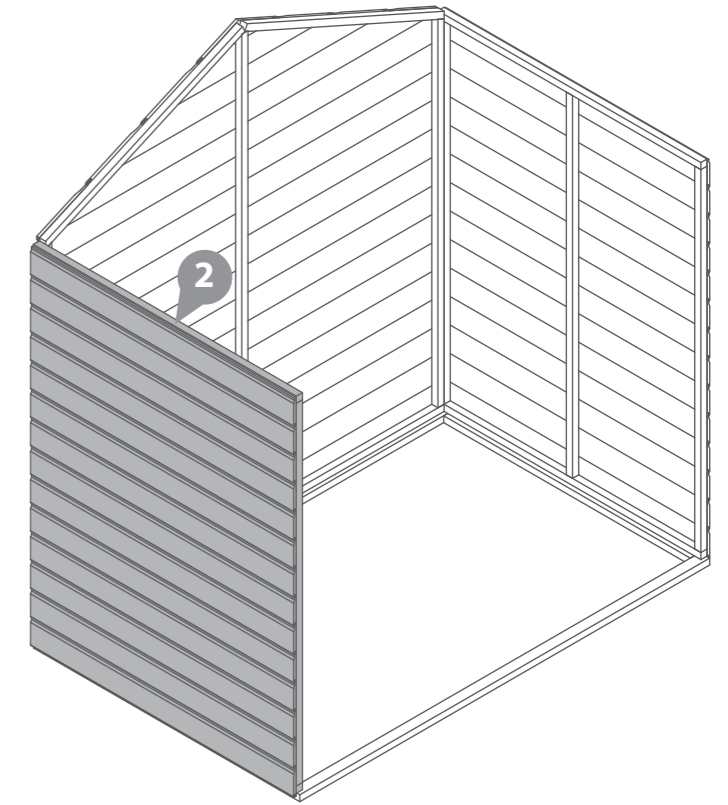

Step 4

Fix the front Panel (No. 1) to the side panels with 8x50mm screws.

8x50mm screws.

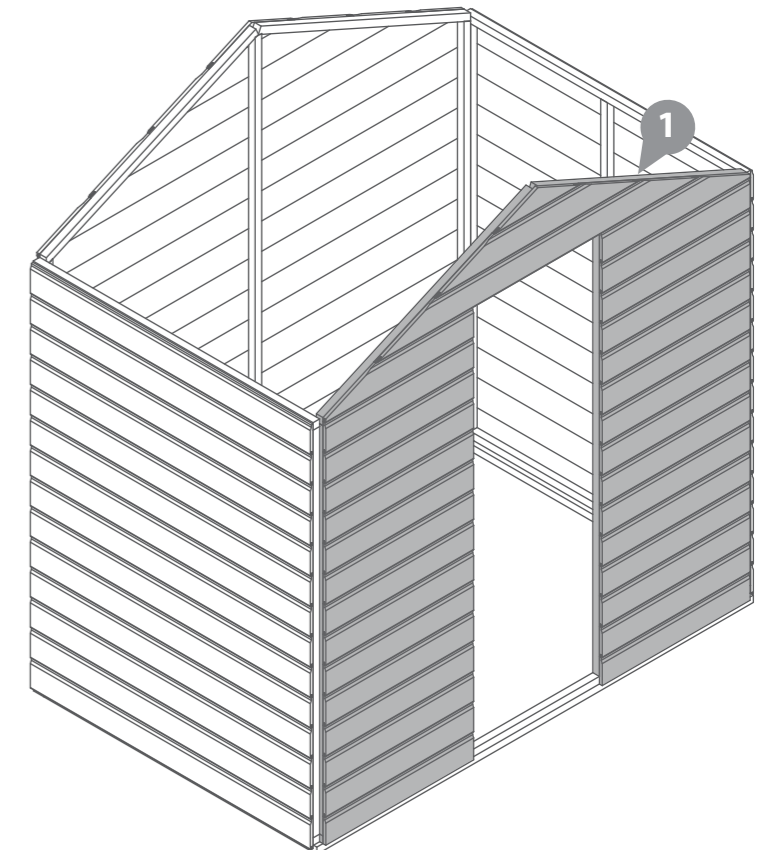

Step 5

*If you have purchased an extension pack B then skip to pack B step 1a.

Place the remaining bearers (No. 21 & No. 25) into position and secure to each with 2x70mm screws.

The Run base framing does not fix to the Kennel area

****Do NOT fix to the base framing until the Roof is secured****

4x70mm screws.

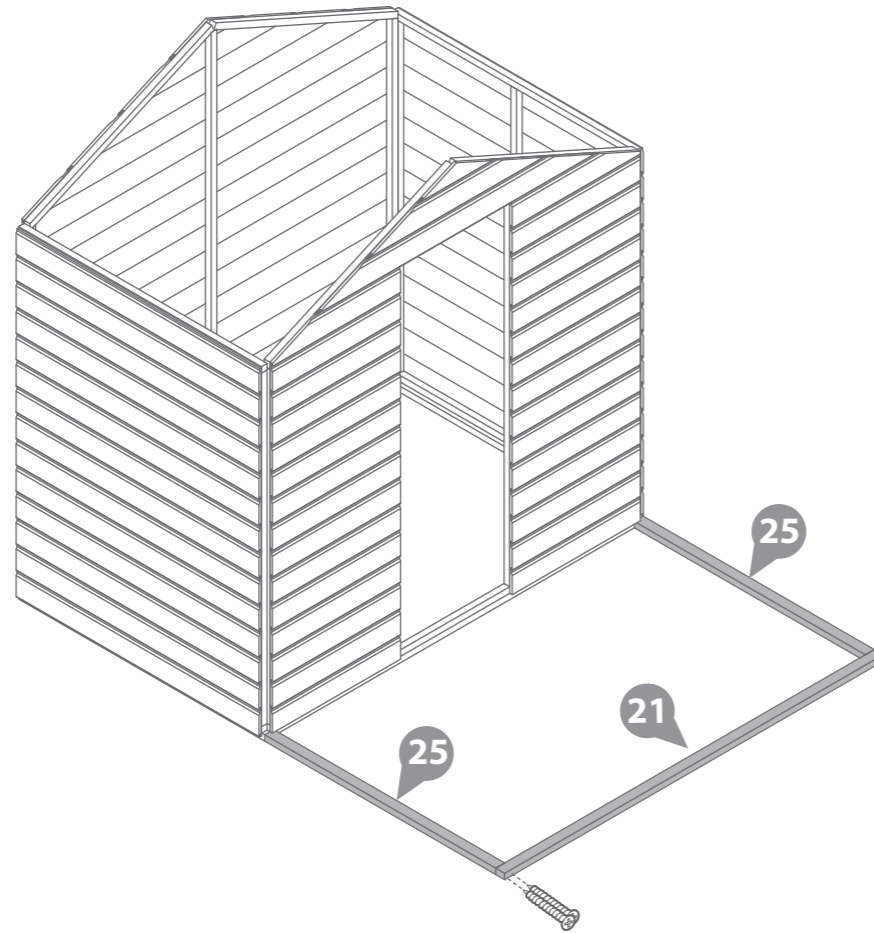

Step 6

Fix the mesh Panels (No. 4) into position and secure with 4x50mm screws per panel.

****Do NOT fix to the base framing until the Roof is secured****

8x50mm screws.

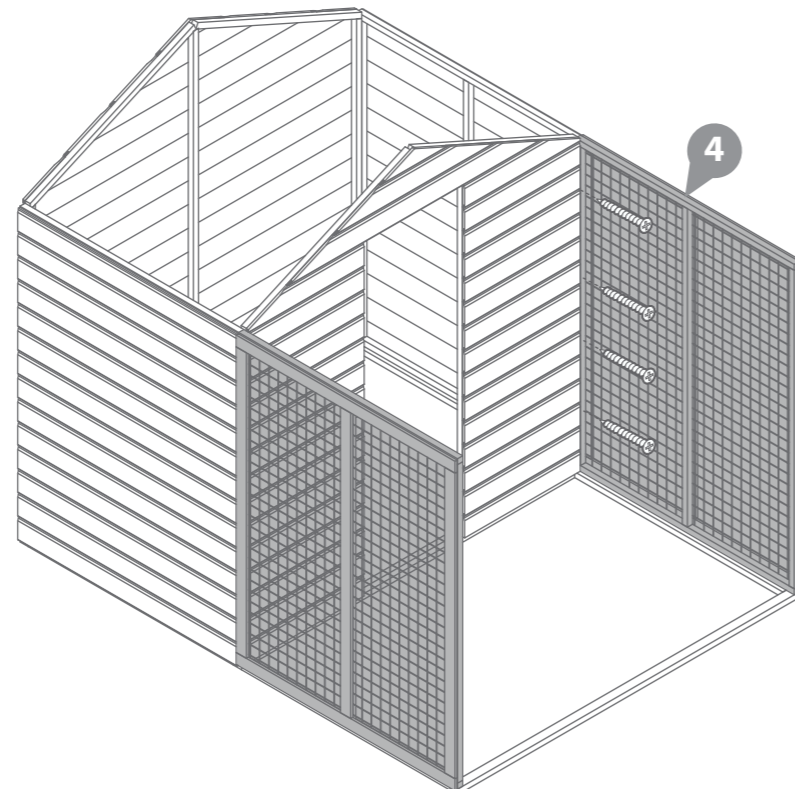

Step 7

Fix the mesh Panels (No. 6) into position and secure with 4x50mm screws per panel, making sure you screw from the inside.

****Do NOT fix to the base framing until the Roof is secured****

8x50mm screws.

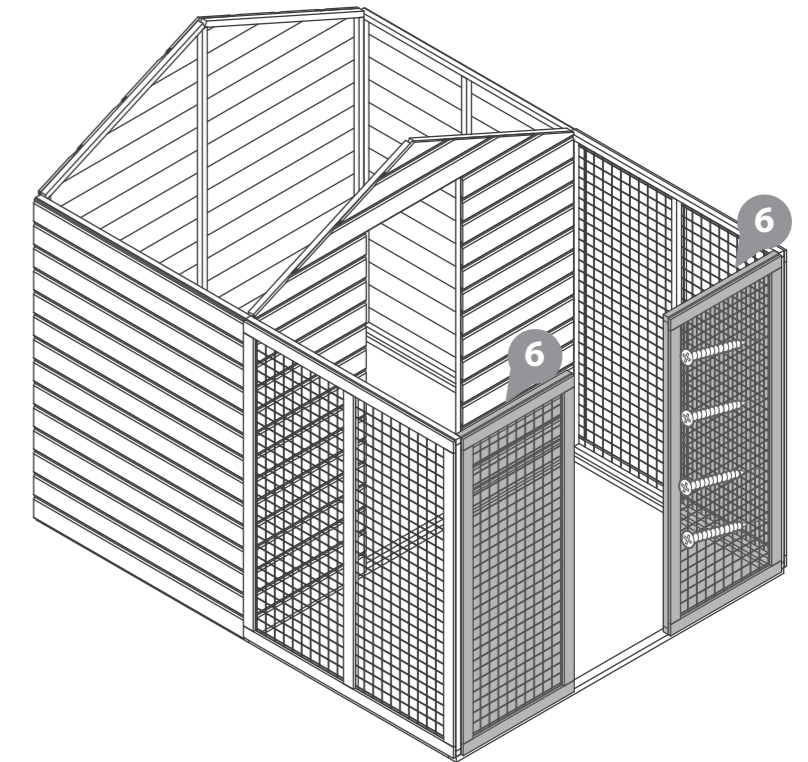

Step 8

Fix the Gable (No. 10) into position and secure with 8x50mm screws per panel. Fix the ply triangle (No. 17) to the top and bottom of the door with 2x40mm screws as shown in the illustration.

****Do NOT fix to the base framing until the Roof is secured****

8x50mm screws
4x40mm screws

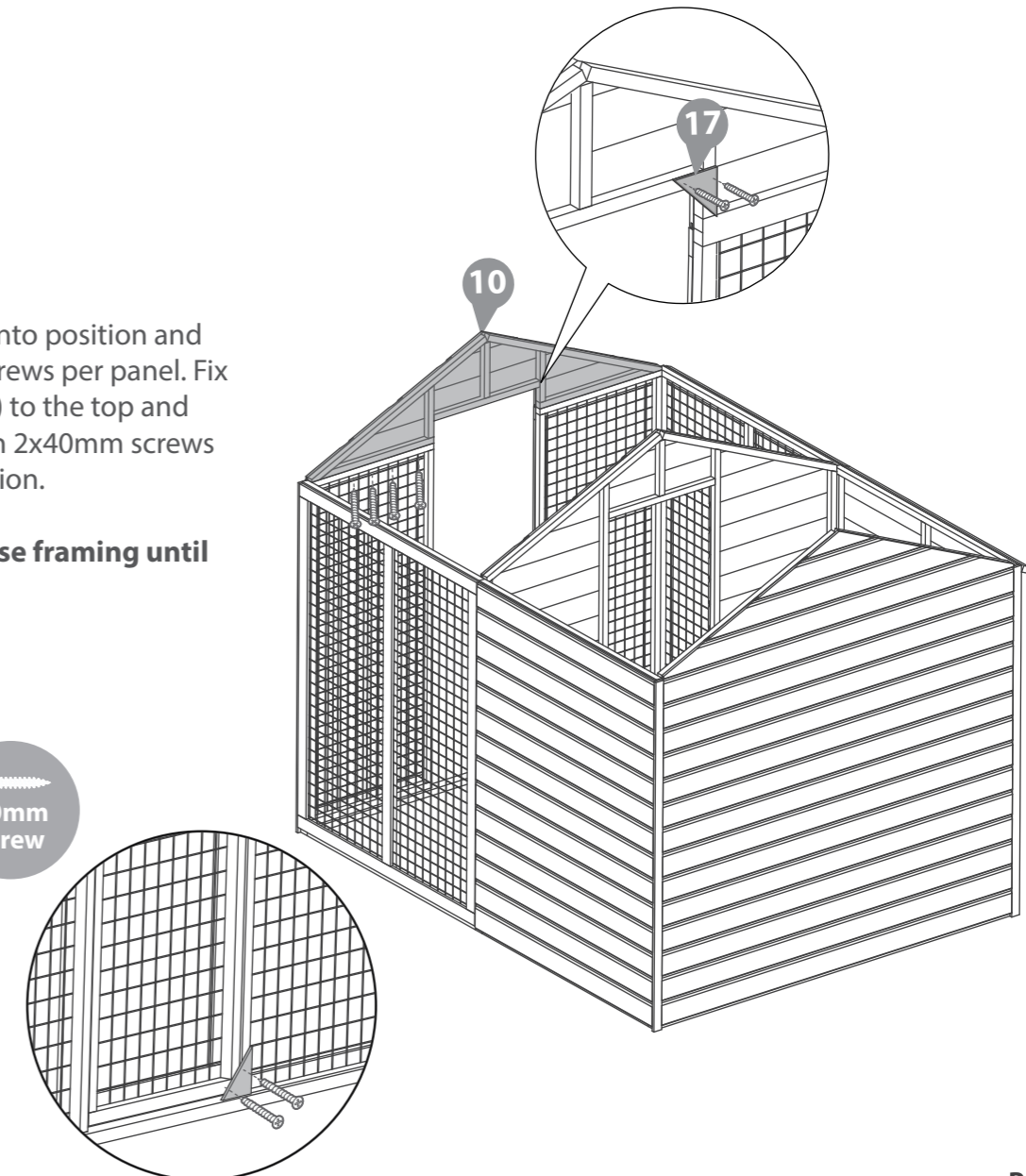
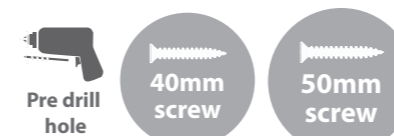

Step 9

Use the ridge bars (No. 19 & No. 22) to position the L brackets (No. 14) marking a line with a pencil. Remove the ridge bar and fasten L brackets to the gables (No. 1, No. 3 & 9) with 2x30mm screws.

Fix the ridge bars (No. 19 & No. 22) onto the L brackets (No. 14) and secure with 2x30mm screws.

Fit the framing (No. 26) flush with the gable top and secure with 3x50mm screws per frame.

****Do NOT fix to the base framing until the Roof is secured****

16x30mm screws
6x50mm screws

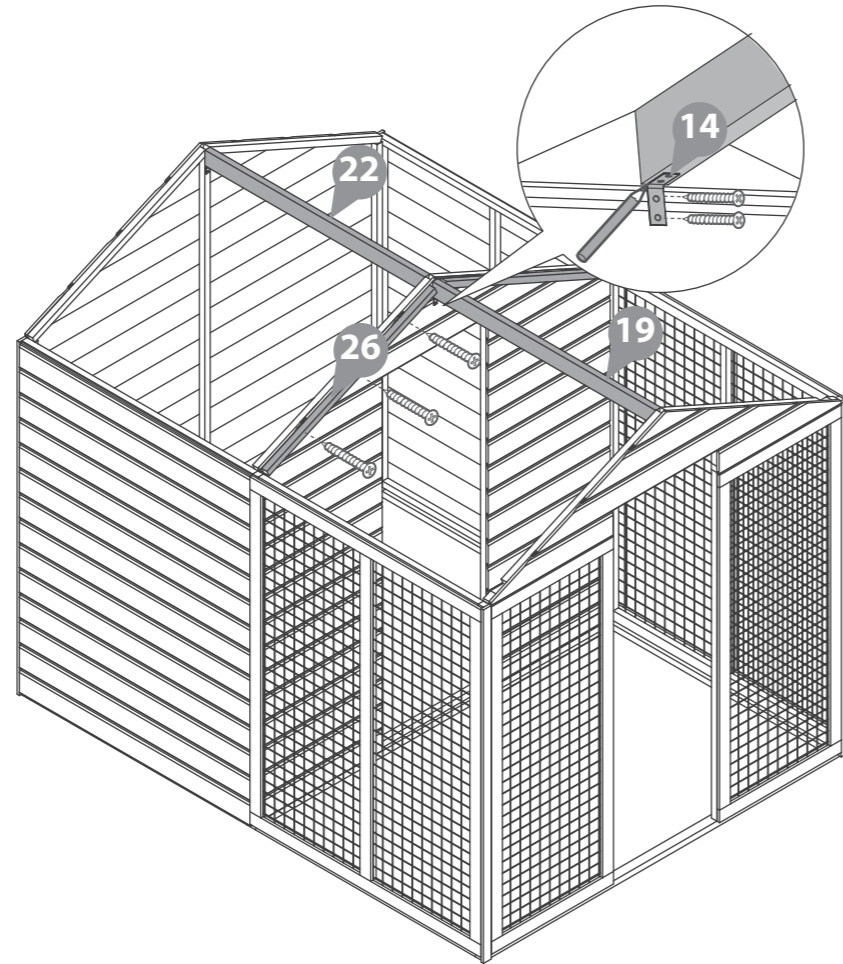
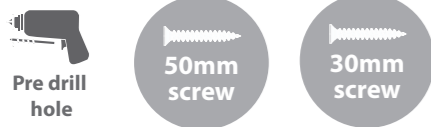

Step 11

Fix the assembled roof panels to the building with 12x30mm screws per roof sheet.

****Do NOT fix to the base framing until the Roof is secured****

48x30mm screws.

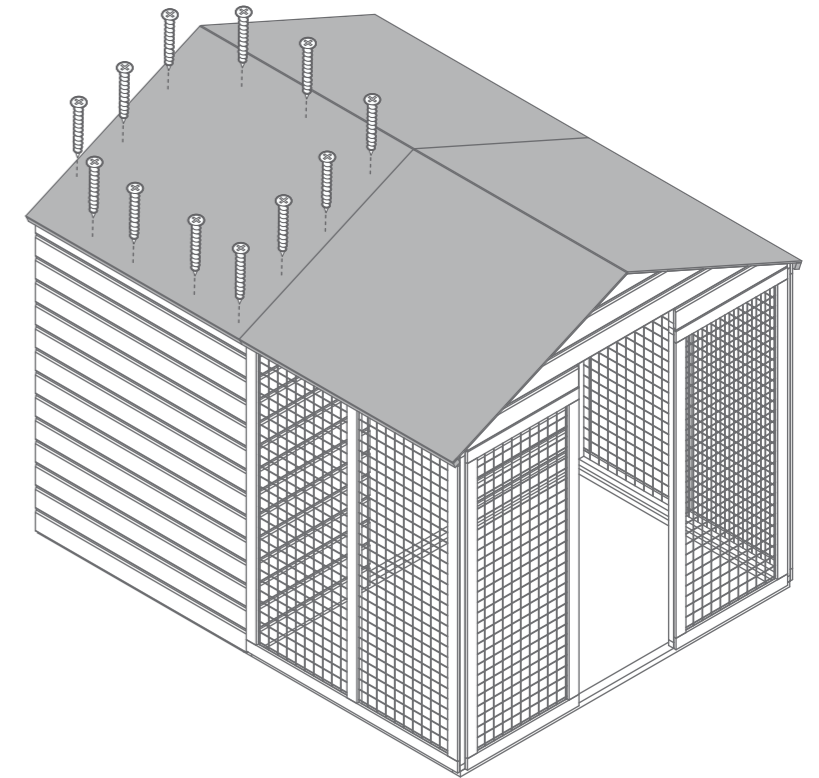

Step 10

Fix the Eaves Frames (No. 23) to the longest side of the Roof OSB (No. 11) with 3x30mm screws per Eaves frame.

****Ensure you fix the eaves frame to the roof before you place the roof on the building.**

****Do NOT fix to the base framing until the Roof is secured****

12x30mm screws.

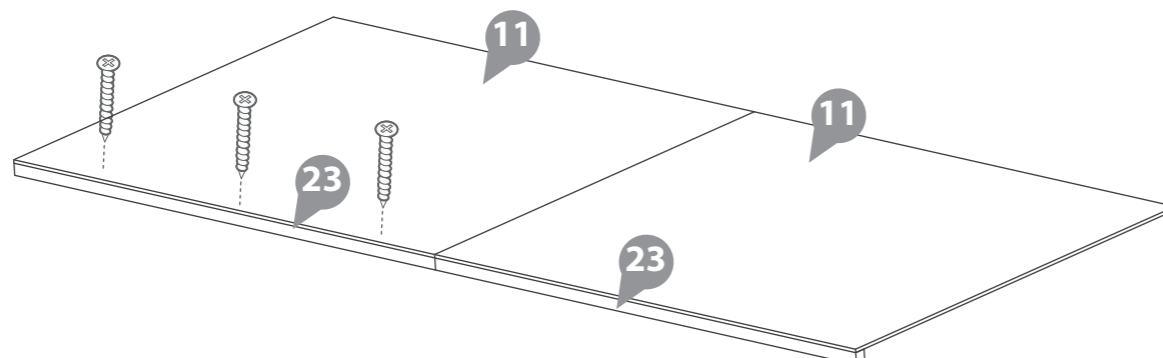

Step 12

Fix the building to the Base Framing using 50mm screws evenly spaced inside the dog kennel area, screwing through the panel framing.

Use 70mm screws to secure the mesh panels to the base frame. 4 screws per panel.

16x50mm screws
12x70mm screws

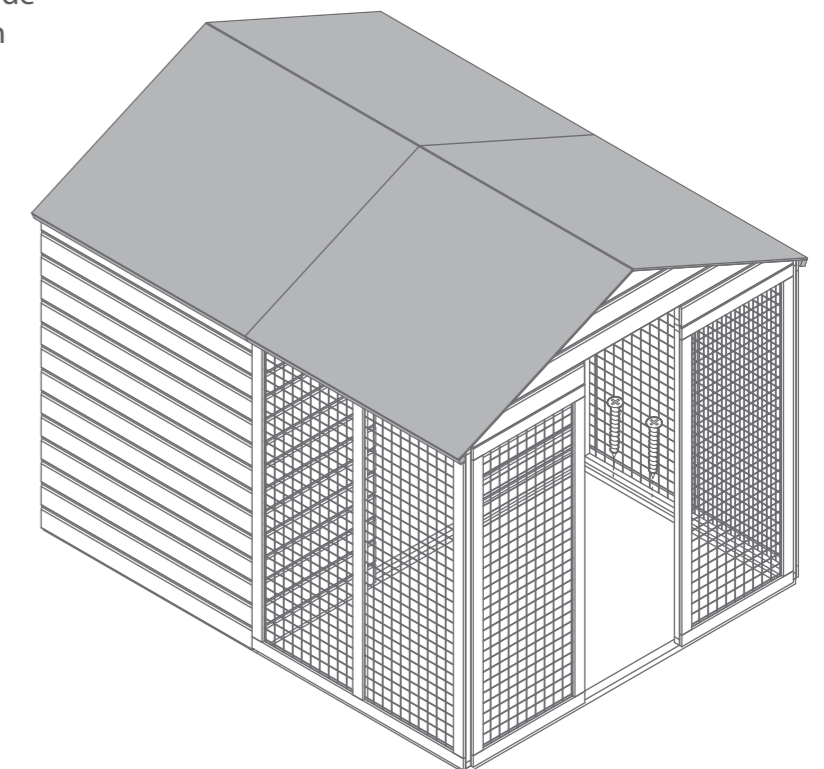

Step 13

Fix the 4x T Hinges (No.12) onto the doors (No. 7 & 8) and door frame as shown with 7x30mm screws.
Fix the turn button (No.15) to one of the boards using 1x30mm black screws.

Note: If you have a large dog then you may be more inclined to fit the larger door at the bottom.

28x30mm screws.
4x30mm Black screws

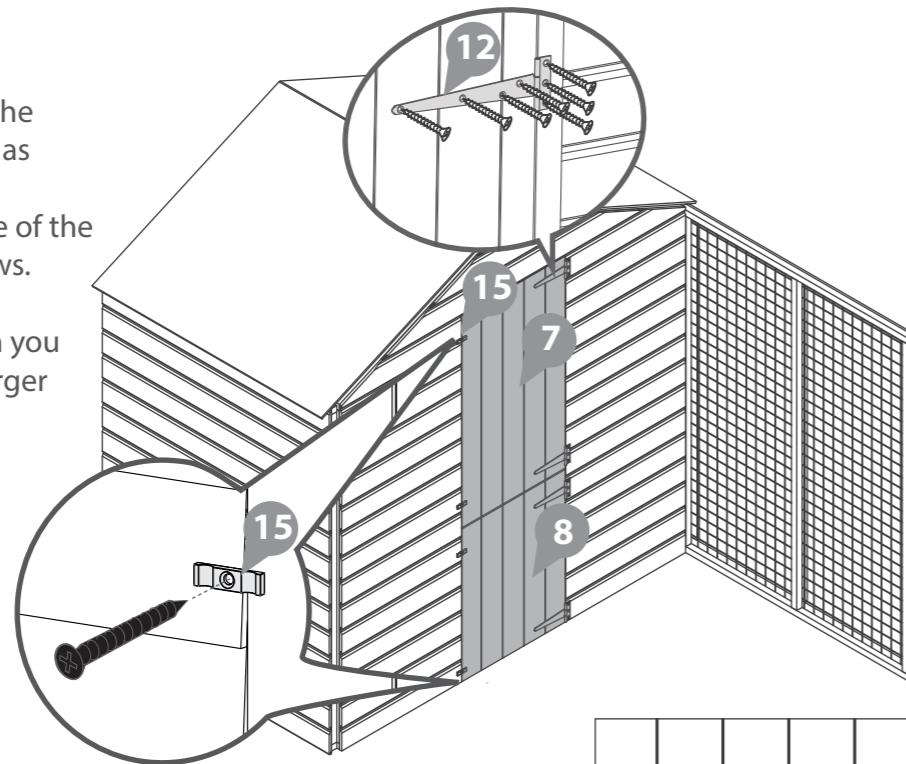
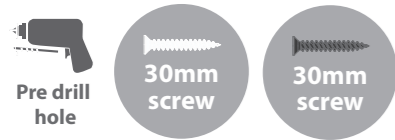

*Note: Hinges to go on the side with the shortest gap.

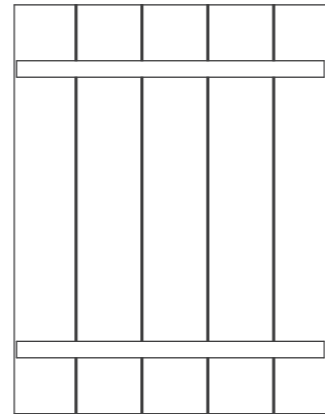

Step 14

Fix the door strip (No. 27) to the door opposite the hinges and secure with 4x30mm screws.

4x30mm screws.

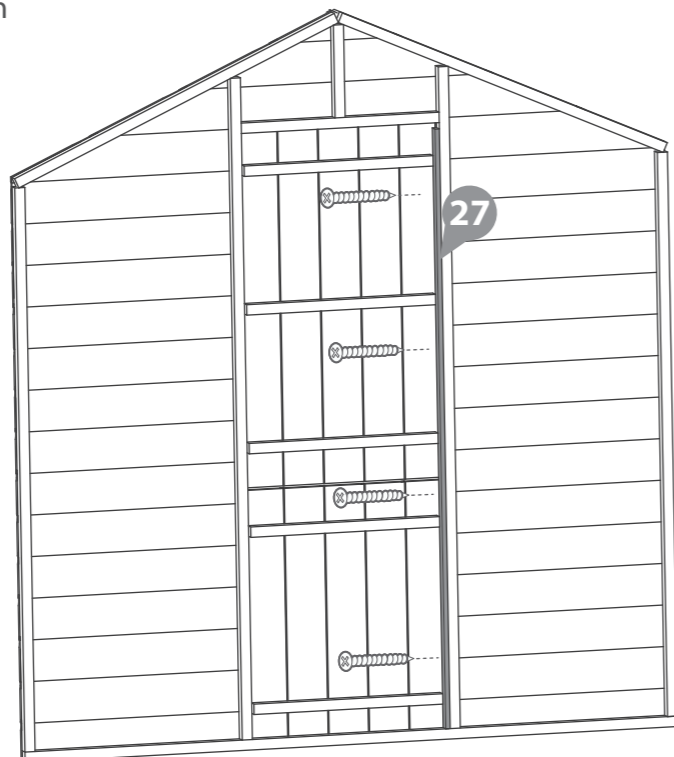

Step 15

Fix the cover trims (No. 24) to the corners of the building with 4x30mm screws.

16x30mm Screws.

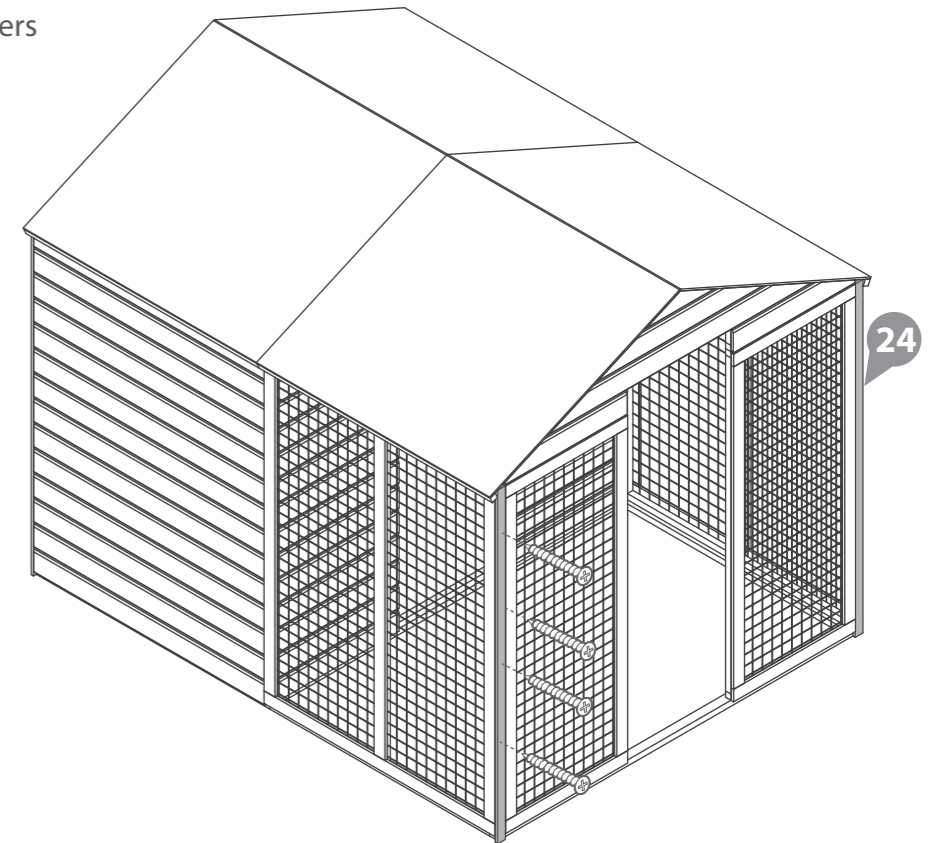

Step 16

Cut the Felt (No. 28, 29) into 3 sheets and lay onto the roof.

*Ensure there is approximately 50mm of overhang around the building.

Fix into place using 100x felt tacks at 100mm intervals.

100x Felt tacks Felt Length 2500mm



*Ensure you overlap the felt by 100mm.

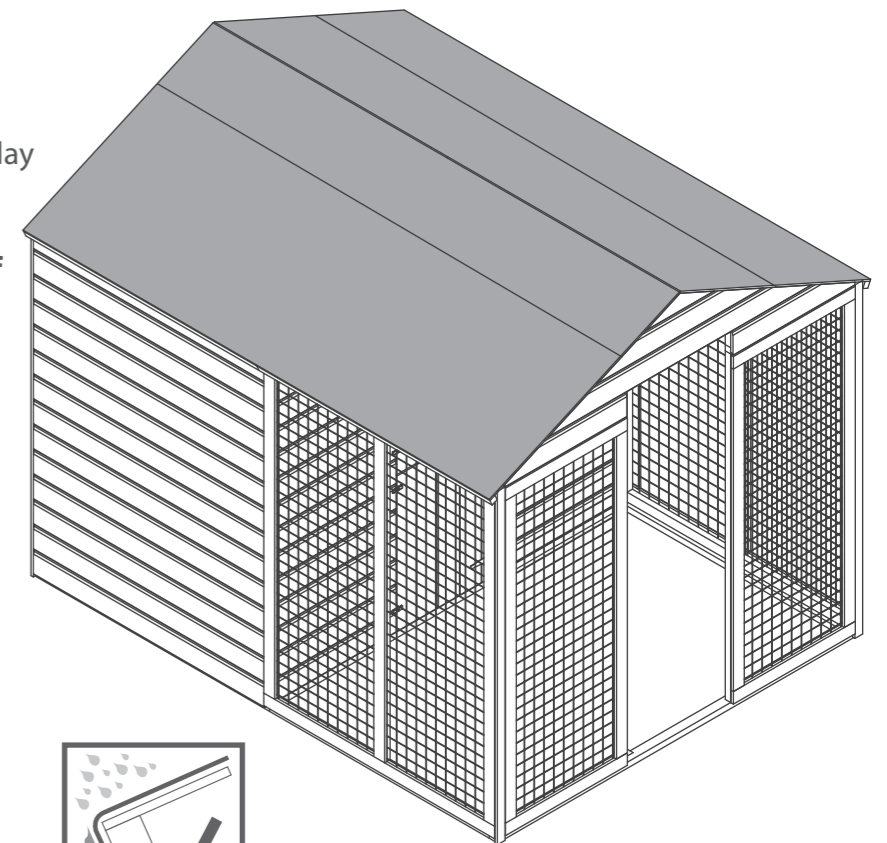
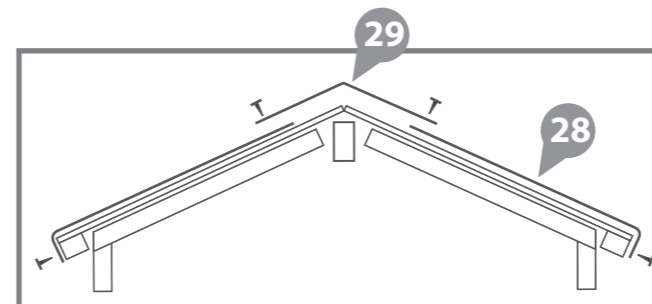

Step 17

Attach the fascias (**No. 18**) to the front and rear of the building with 4x40mm screws per fascia.

Once in place, cut of the excess material of the fascia with a hand saw. Fix on the Finials (**No. 13**) on to the fascias with 2x30mm screws

4x30mm screws
16x40mm screws.

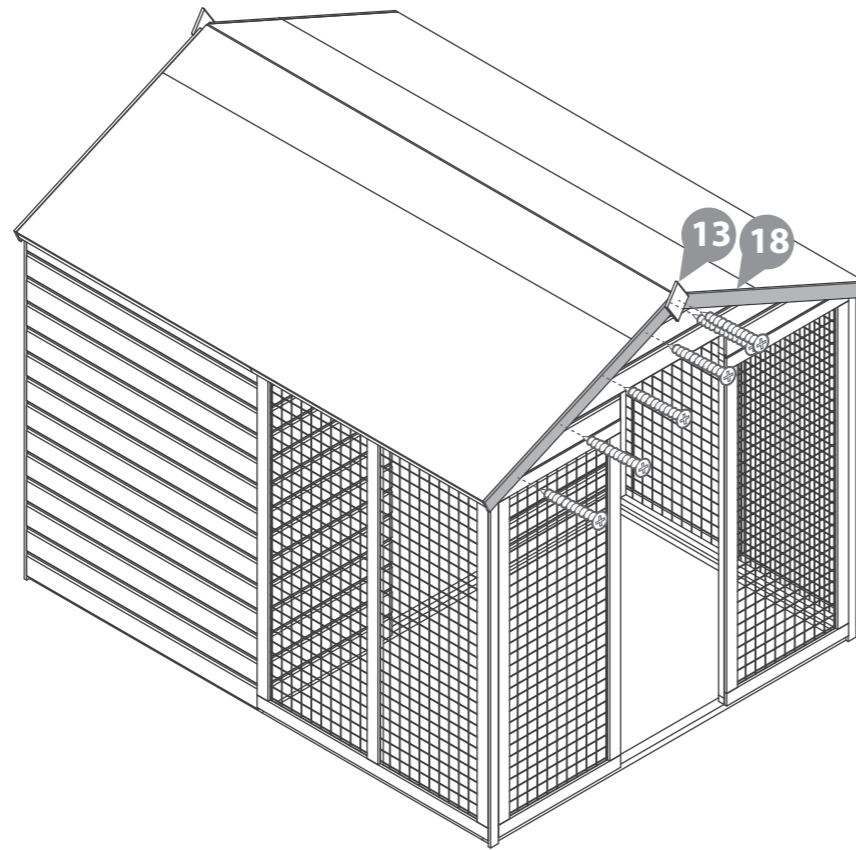

Step 19

Finally, slot the flooring (**No. 9**) into the dog run.

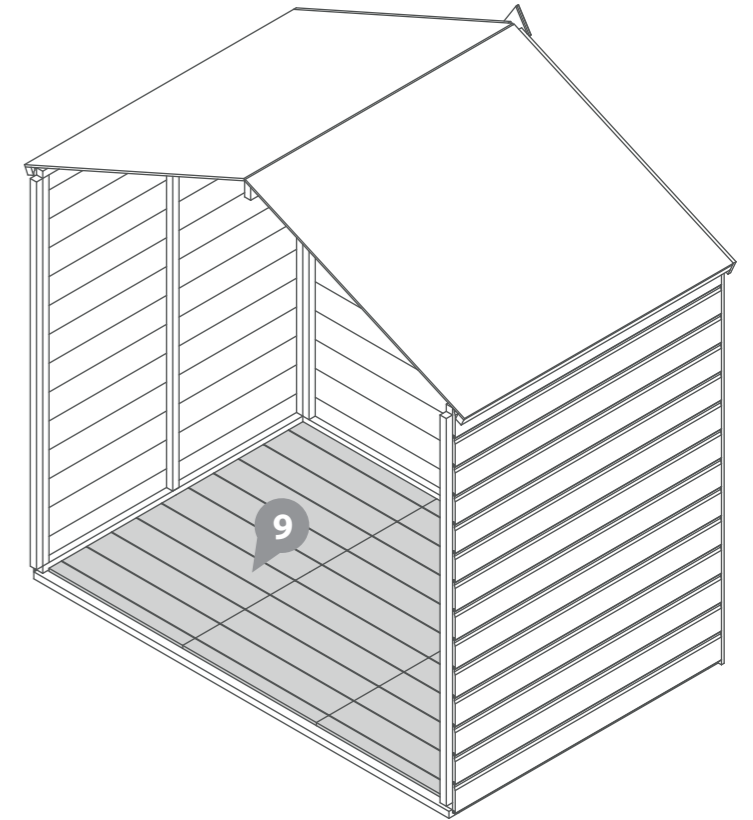

Step 18

Fix the 3x T hinges (**No. 12**) onto the door (**No. 5**) and door frame as shown in the previous diagram.

21x30mm Black Screws.

Fit the turn buttons (**No. 15**) to the building using 1x30mm black screws as shown in the previous diagram.

2x30mm Black Screws.

Fix the pad bolt (**No. 16**) with 6x30mm screws on the horizontal brace on the door. Then fix the pad bolt retainer to the door pannel framing using 4x30mm screws.

10x30mm screws

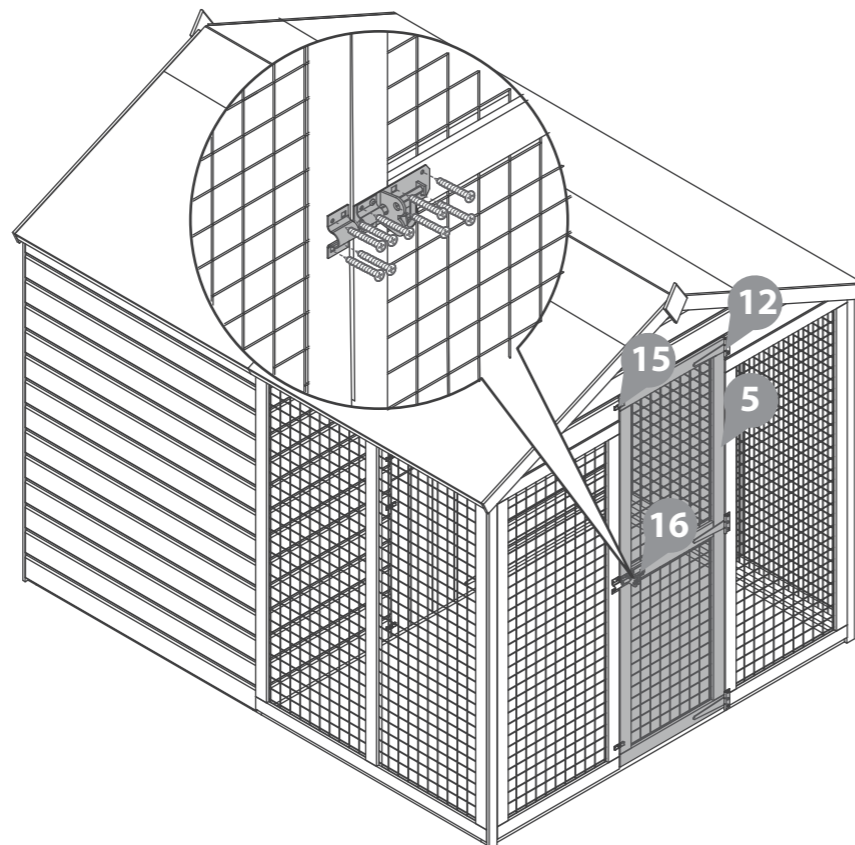
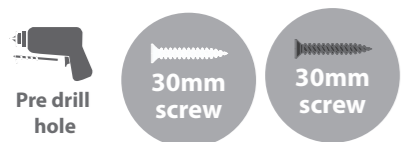

Pack B

Step 1a

Place the Base bearers (No. 21, 25 & 36) into position and secure to each with 2x70mm screws.

****Do NOT fix to the base framing until the Roof is secured****

8x70mm screws.

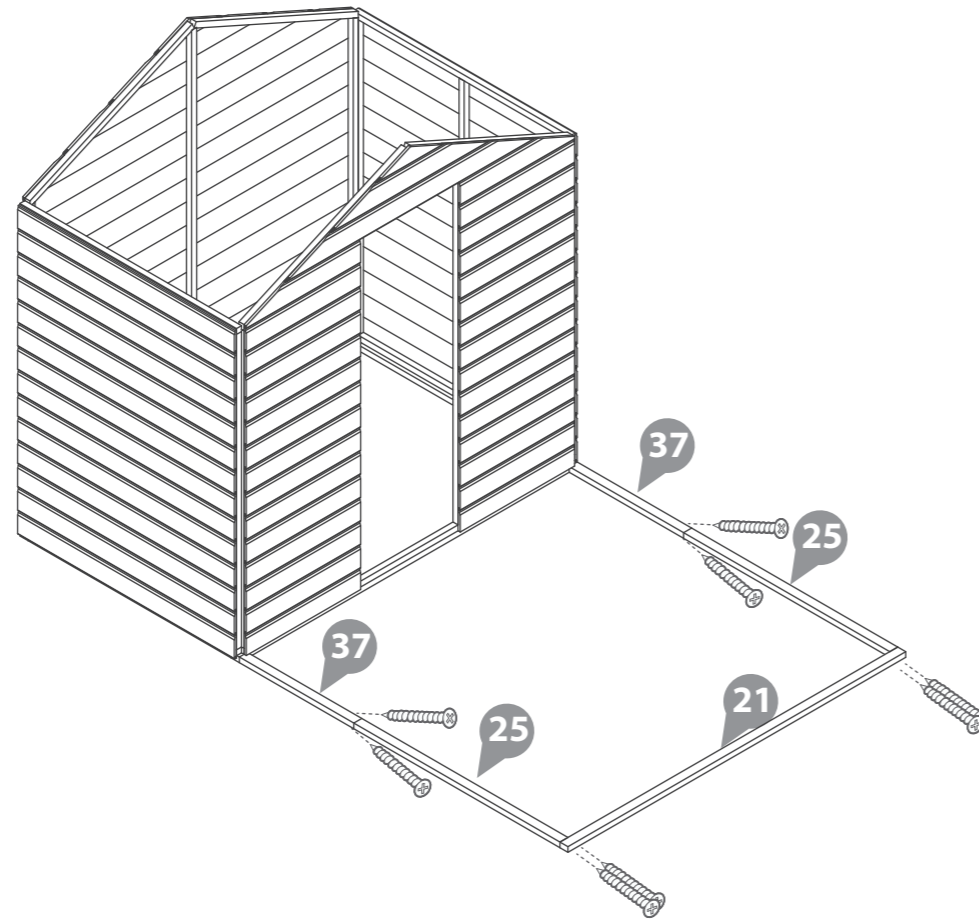

Step 3a

Fix the mesh Panels (No. 4) into position and secure with 4x50mm screws per panel.

****Do NOT fix to the base framing until the Roof is secured****

8x50mm screws.

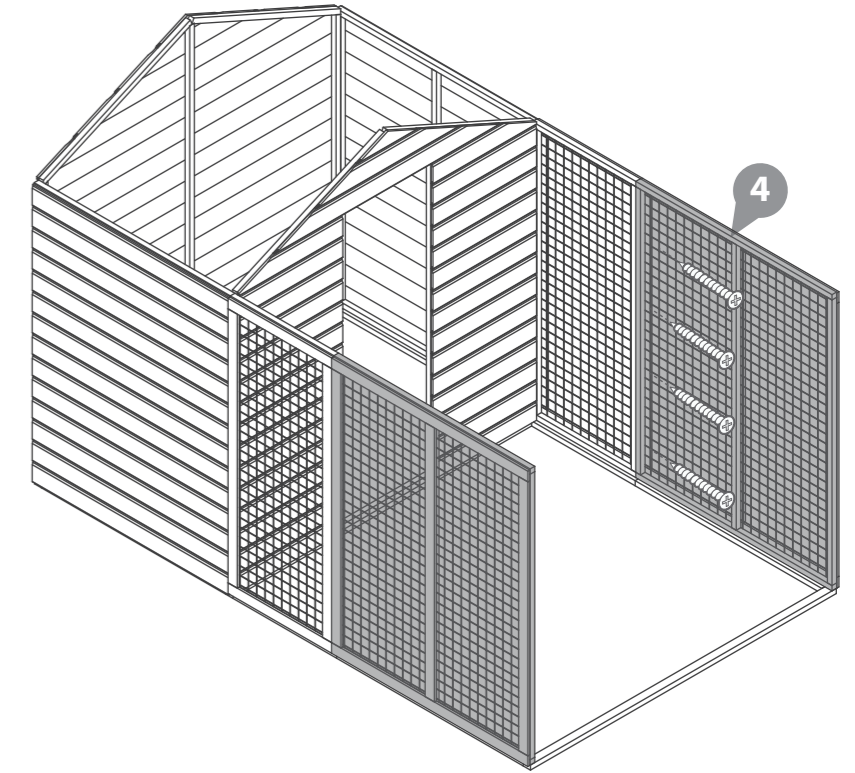

Step 2a

Fix the mesh Panels (No. 30) into position and secure with 4x50mm screws per panel.

****Do NOT fix to the base framing until the Roof is secured****

8x50mm screws.

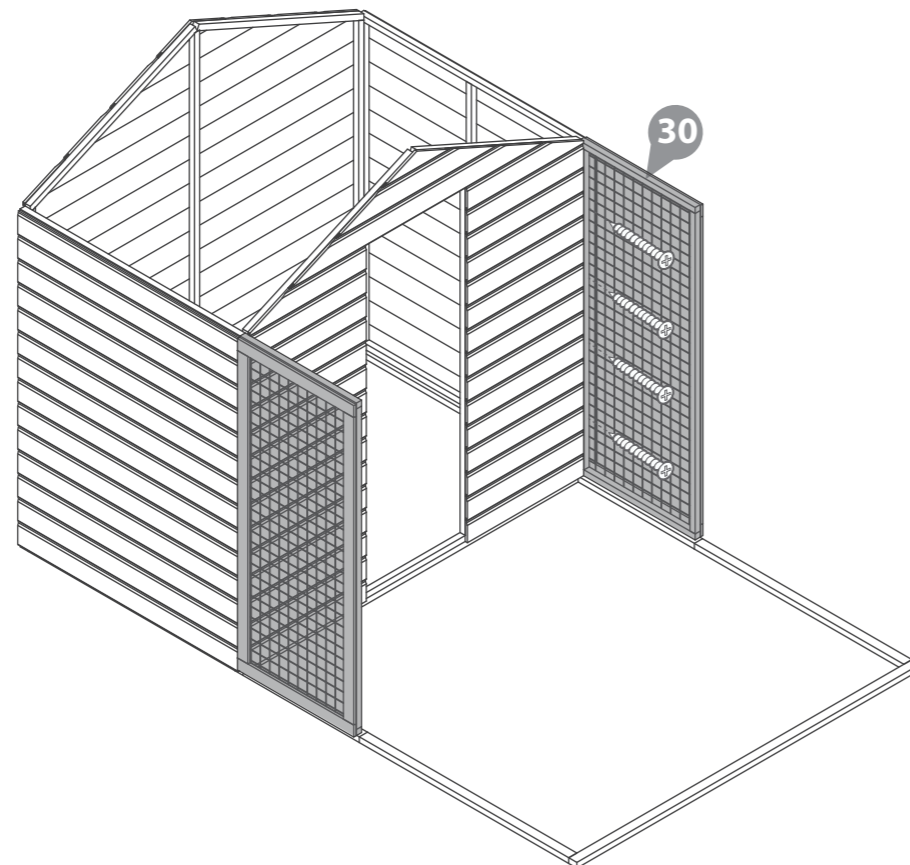

Step 4a

Fix the mesh Panels (No. 6) into position and secure with 4x50mm screws per panel screwing from the inside of the building.

****Do NOT fix to the base framing until the Roof is secured****

8x50mm screws.

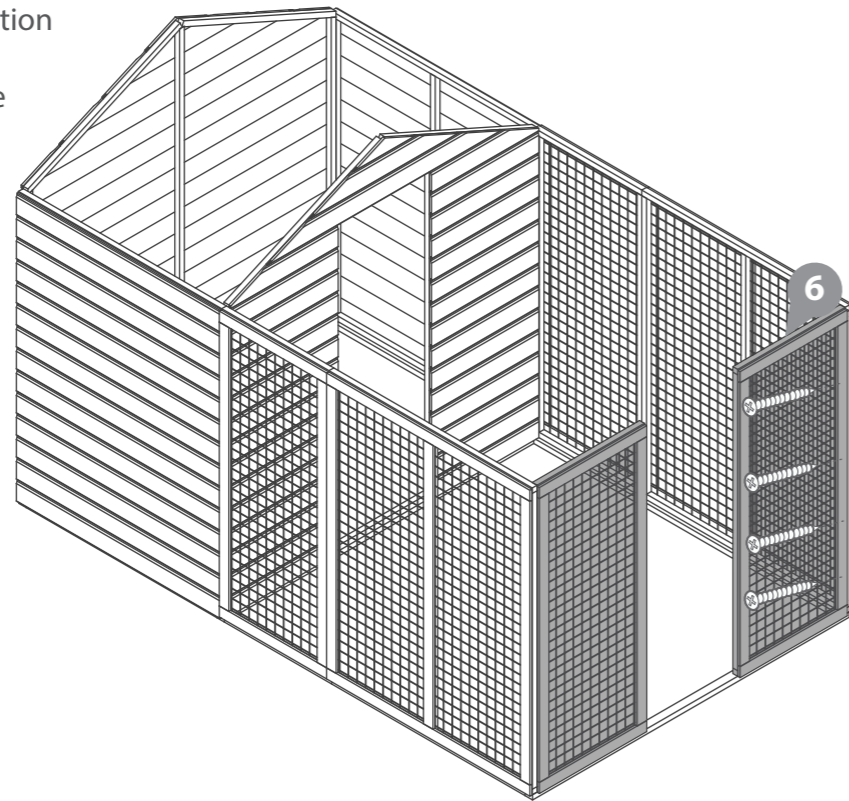

Step 5a

Fix the Gable (No. 9) into position and secure with 8x50mm screws. Fix the ply triangle (No. 17) to the top and the bottom of the door with 2x40mm screws as shown in the illustration.

****Do NOT fix to the base framing until the Roof is secured****

8x50mm screws.
4x40mm screws

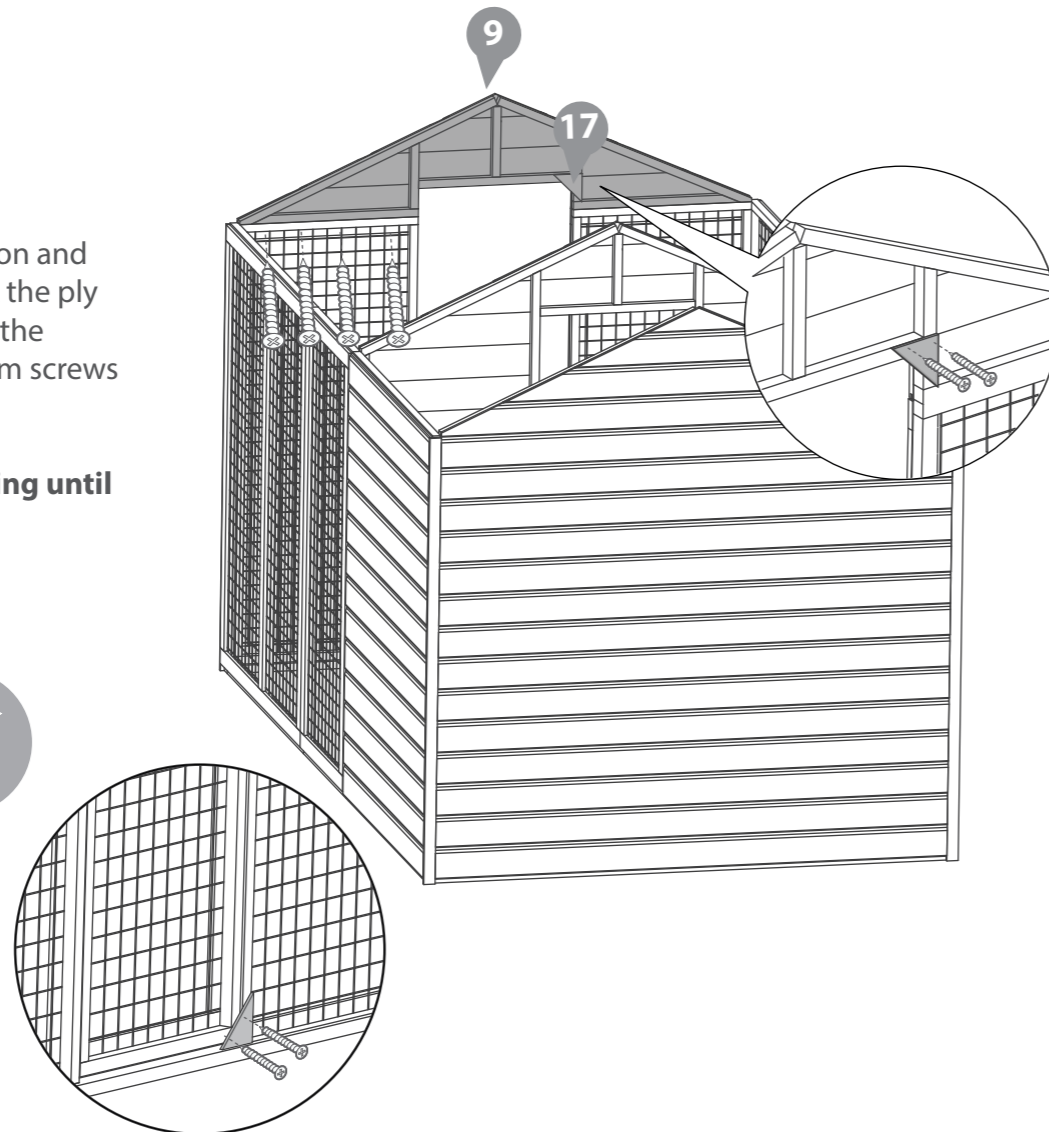

Step 6a

Use the ridge bars (No. 19, No. 33 & No. 22) to position the L brackets (No. 14) marking with a pencil. Remove the ridge bar and fasten L brackets to the gables (No. 1, No. 3 & No. 10) with 2x30mm screws.

Fix the ridge bars (No. 19, No. 33 & No. 22) onto the L brackets (No. 14) and the U channel (No. 31) and secure with 2x30mm screws.

Fit the framing (No. 26) flush with the gable top and secure with 3x50mm screws per frame.

****Do NOT fix to the base framing until the Roof is secured****

23x40mm screws.
6x50mm screws

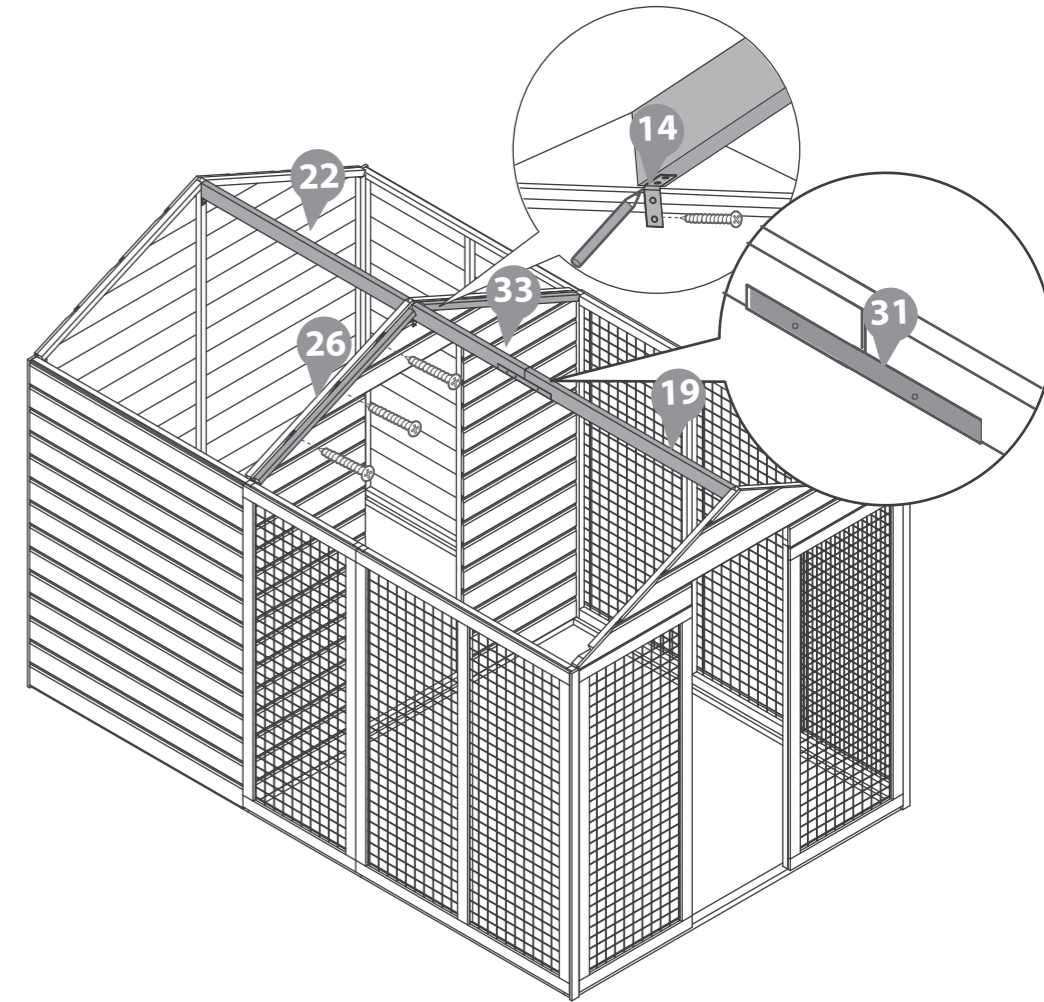

Step 7a

Measure 17mm from the top of the mesh panel and mark with a pencil. Align the top of the block with the pencil line as per the diagram. Fix the blocks (No. 35) into position on both sides securing with 2x40mm screws. Fix truss (No. 34) to the block and the ridge bar with 4x40mm screws. Attach the truss support (No. 36) to the truss's (No. 34) with 4x40mm screws.

****Do NOT fix to the base framing until the Roof is secured****

16x40mm screws.

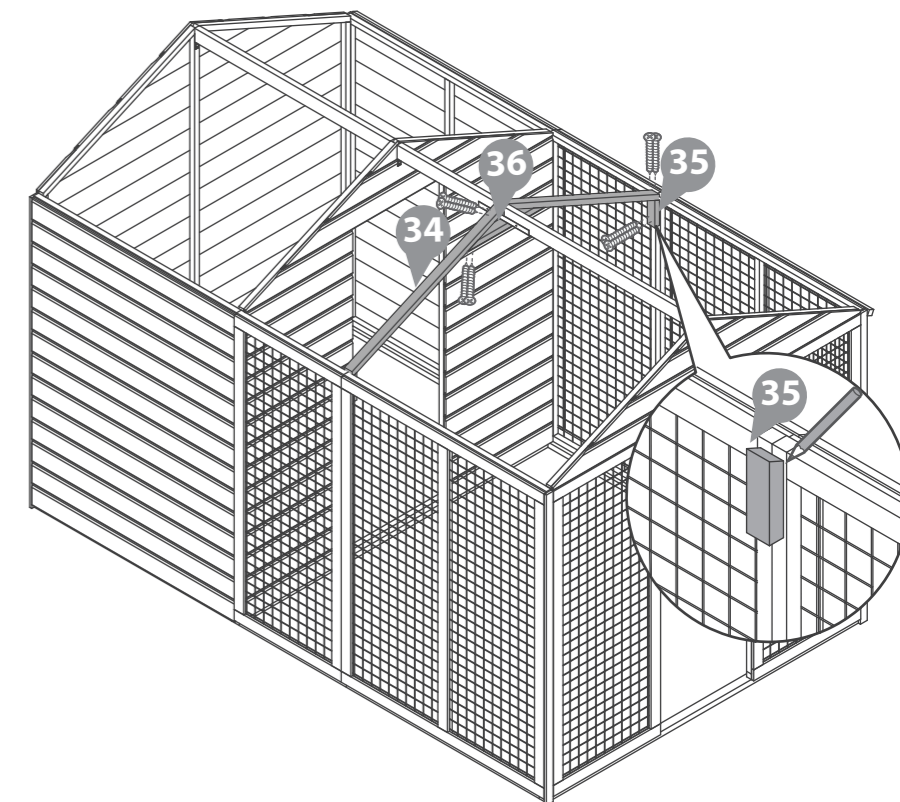
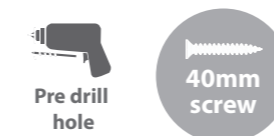

Step 8a

Fix the Eaves Frames (No. 23) to the longest side of the (No. 11) roof OSB. Fix eaves frame (No. 38) to the shortest side of the (No. 32) roof OSB with 3x30mm screws per Eaves frame.

**Ensure you fix the eaves frame to the roof before you place the roof on the building.

Do NOT fix to the base framing until the Roof is secured

18x30mm screws.

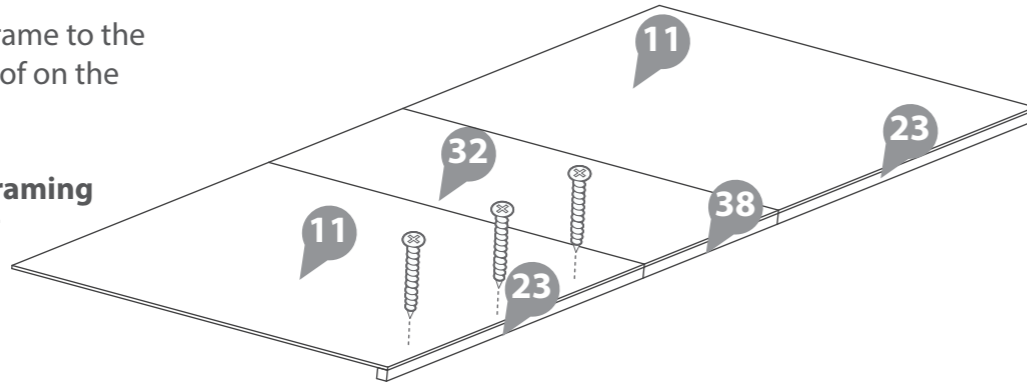

Step 10a

Fix the building to the Base Framing using 50mm screws evenly spaced inside the dog kennel area, screwing through the panel framing. Use 70mm screws to secure the mesh pannels to the base frame. 4 screws per panel.

16x50mm screws
16x70mm screws

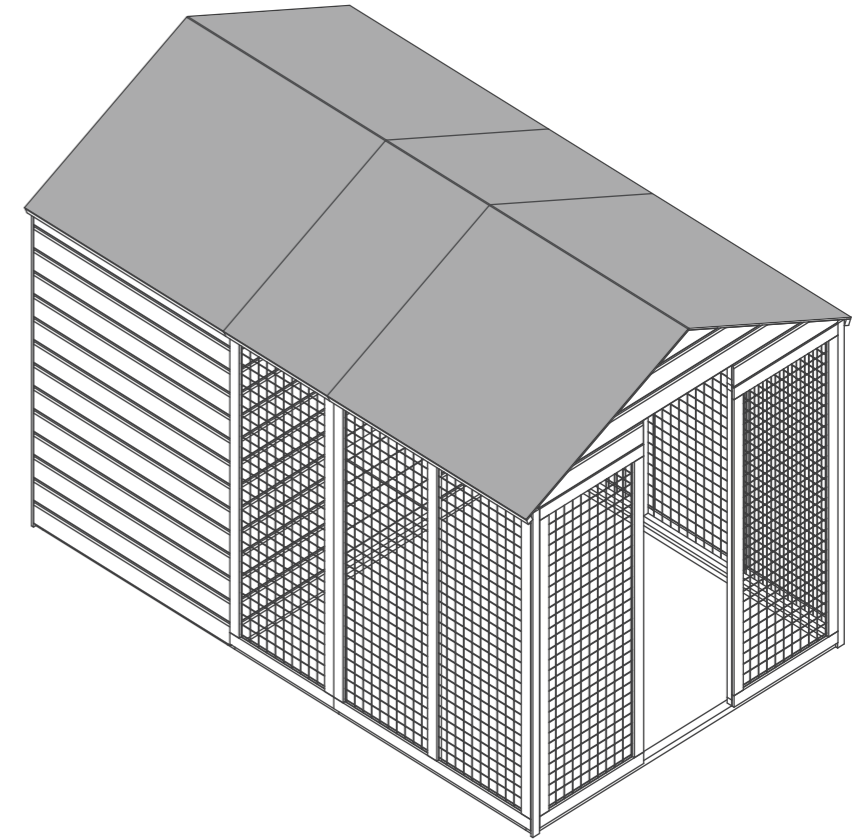

Step 9a

Fix the assembled roof panels to the building with 12x30mm screws per roof sheet.

Do NOT fix to the base framing until the Roof is secured

72x30mm screws.

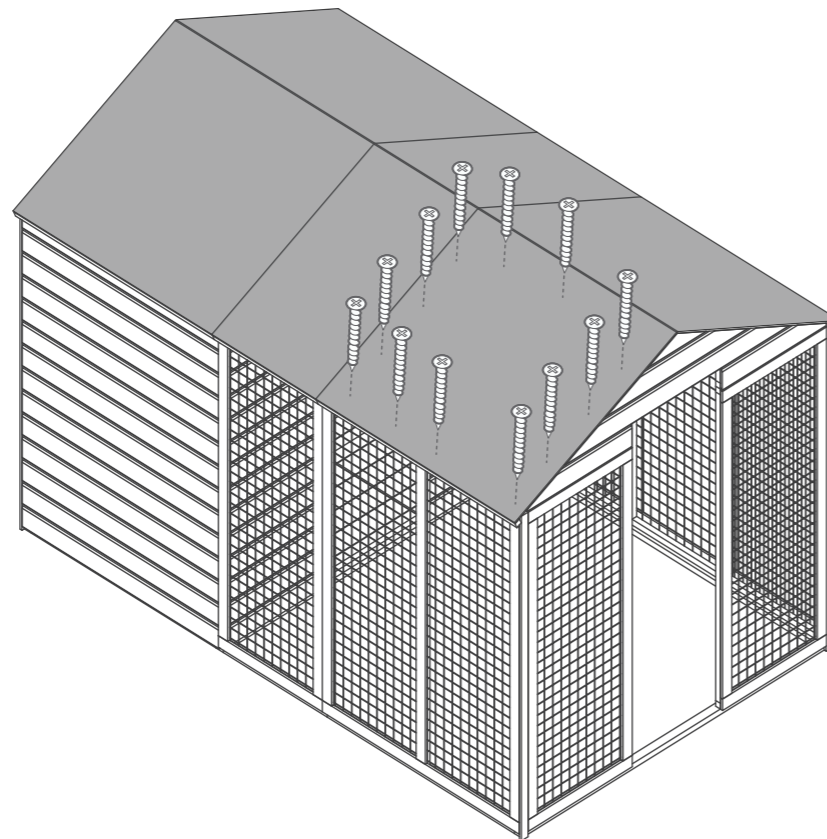

Step 11a

Fix the cover trim (No. 24) to the corners of the building with 4x30mm screws.

16x30mm Screws.

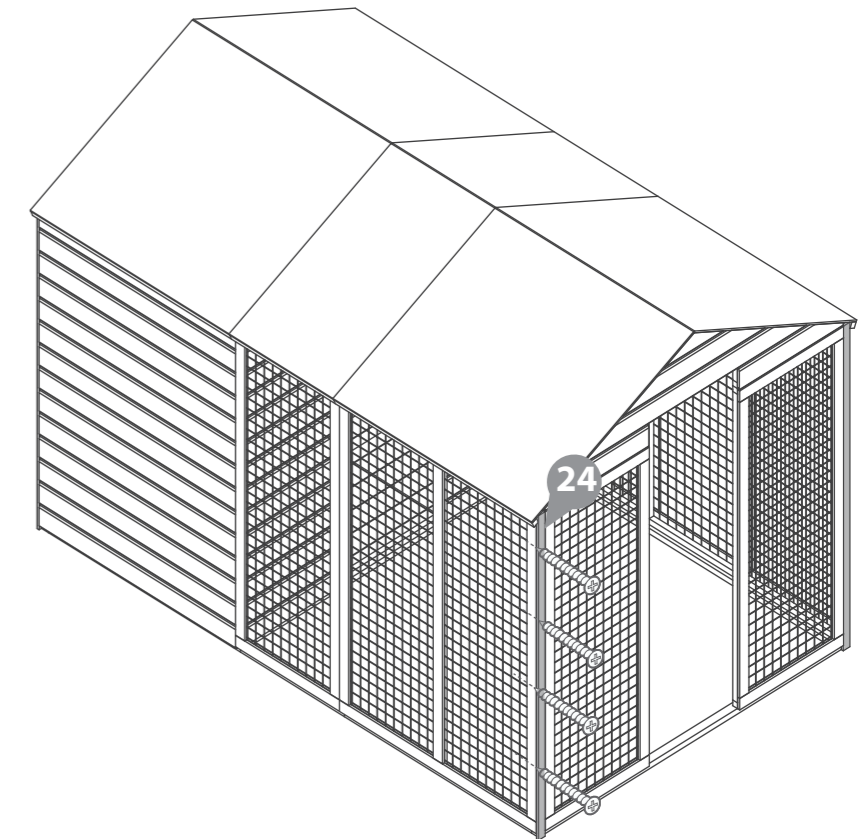

Step 12a

Fix the T Hinges (No.12) onto the doors (No. 7 & 8) and door frame as shown with 7x30mm screws.

Fix the turn button (No.15) to one of the boards using 1x30mm screws.

Note: If you have a large dog then you may be more inclined to fit the larger door at the bottom.

28x30mm screws.
4x30mm Black screws

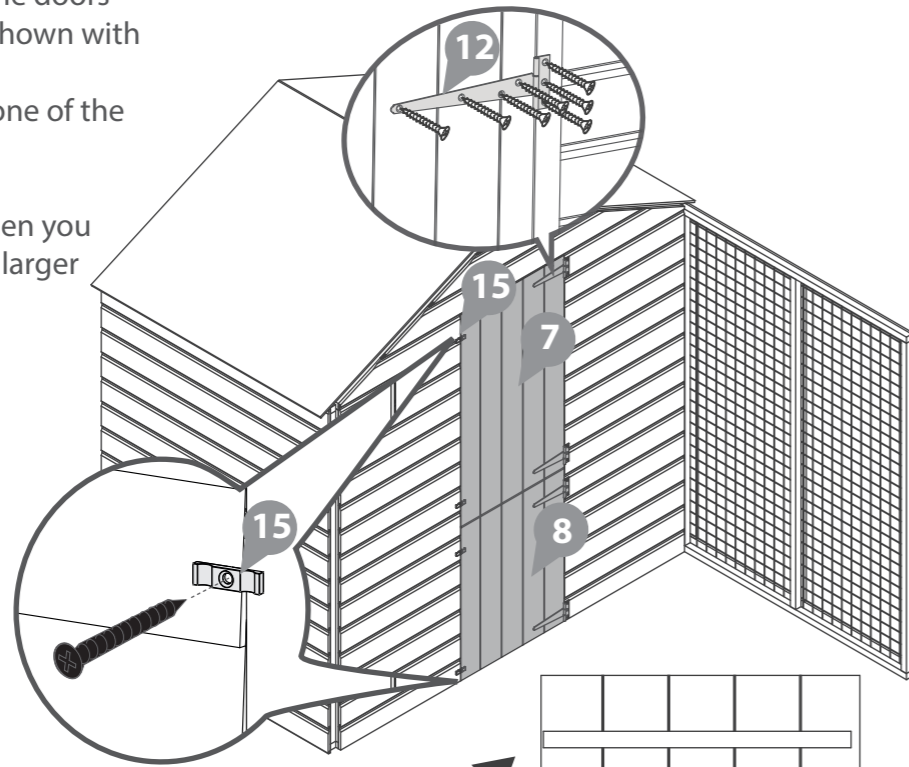
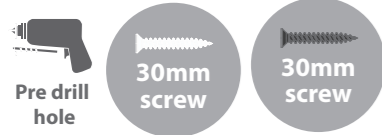

*Note: Hinges to go on the side with the shortest gap.

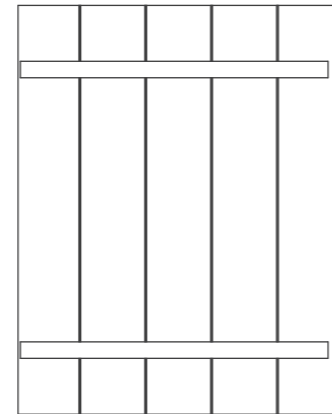

Step 13a

Fix the door strip (No. 26) to the door opposite the hinges and secure with 4x30mm screws.

4x30mm screws.

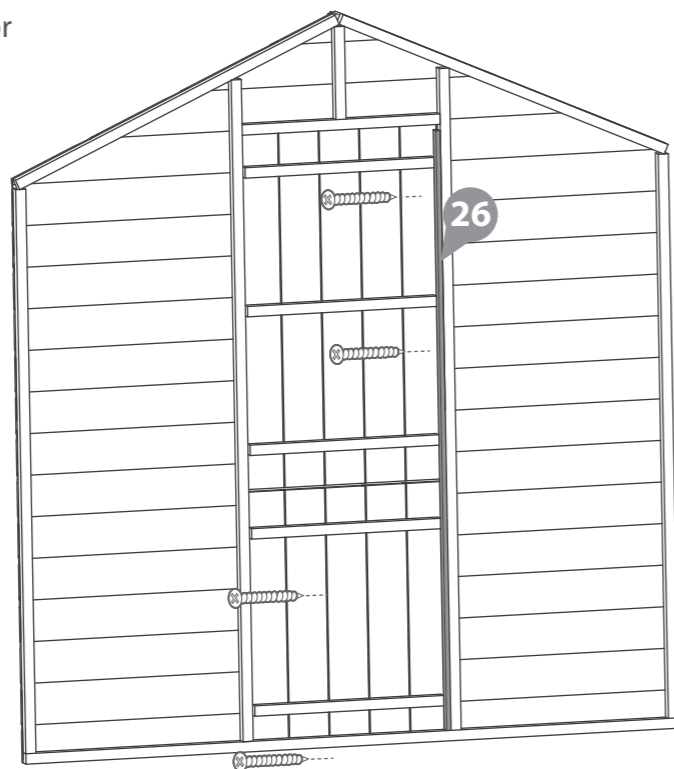

Step 14a

Cut the Felt (No. 28, 29) into 3 sheets and lay onto the roof.

*Ensure there is approximately 50mm of overhang around the building.

Fix into place using 100x felt tacks at 100mm intervals.

150x Felt tacks Felt Length 3140mm



*Ensure you overlap the felt by 100mm.

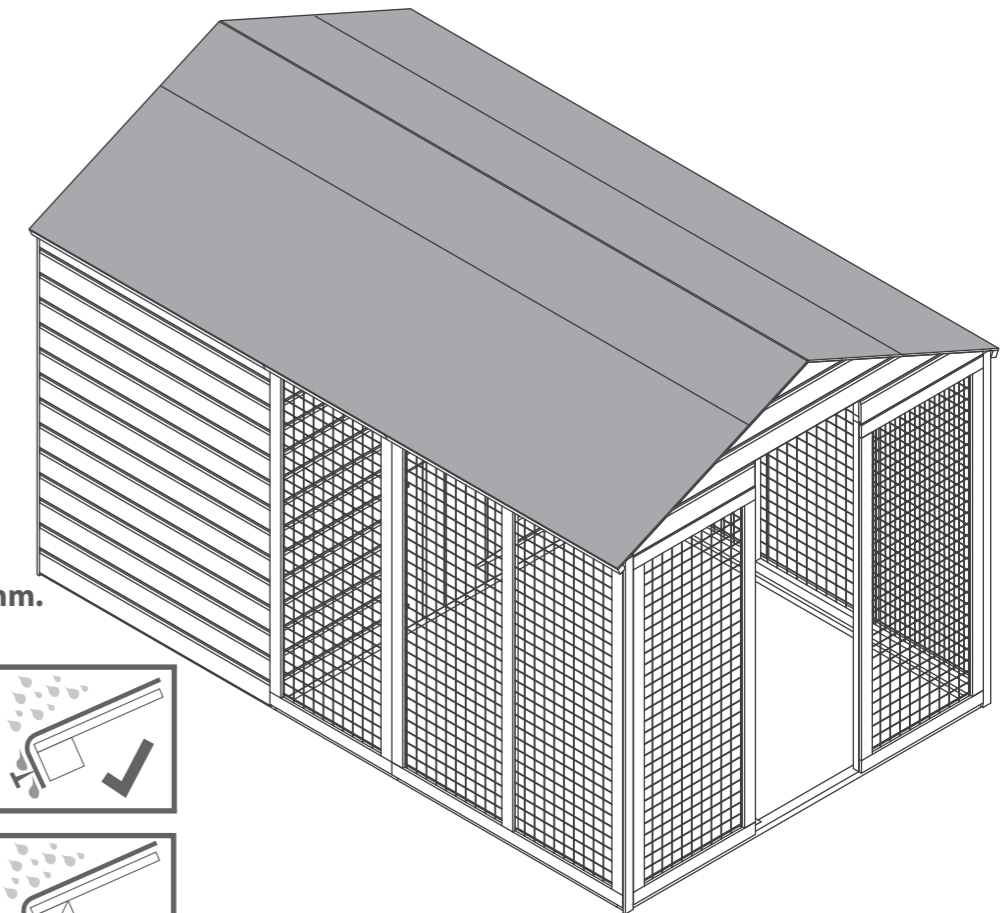
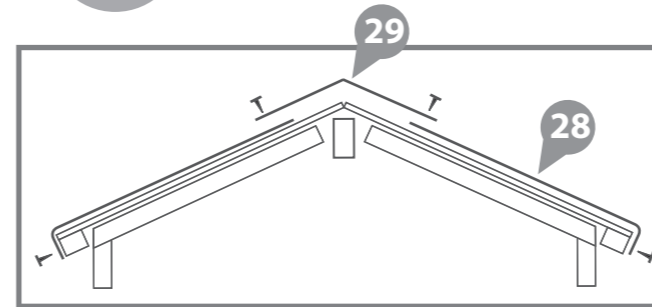

Step 15a

Attach the fascias to the front and rear (No. 18) of the building with 4x40mm screws per fascia.

Once in place, cut of the excess material of the fascia with a hand saw.

Fix on the Finials (No. 13) on to the fascias with 2x30mm screws

4x30mm screws.
16x40mm screws.

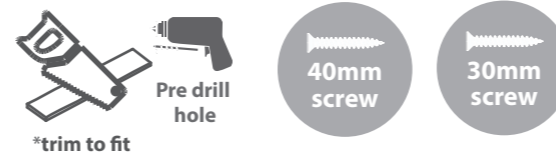

*trim to fit

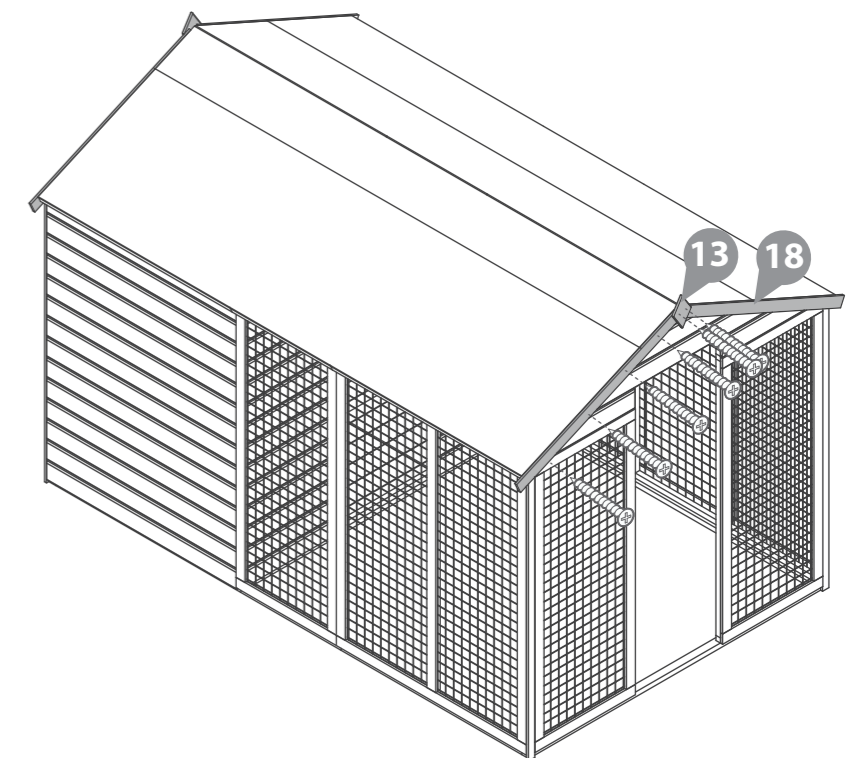

Step 16a

Fix the 3x T hinges (**No. 12**) onto the door (**No. 6**) and door frame as shown in the previous diagram.

21x30mm Black Screws.

Fit the turn buttons (**No. 15**) to the building using 1x30mm black screws as shown in the previous diagram.

2x30mm Black Screws.

Fix the pad bolt (**No. 16**) with 6x30mm screws on the horizontal brace on the door. Then fix the pad bolt retainer to the door panel framing using 4x30mm screws.

10x30mm screws

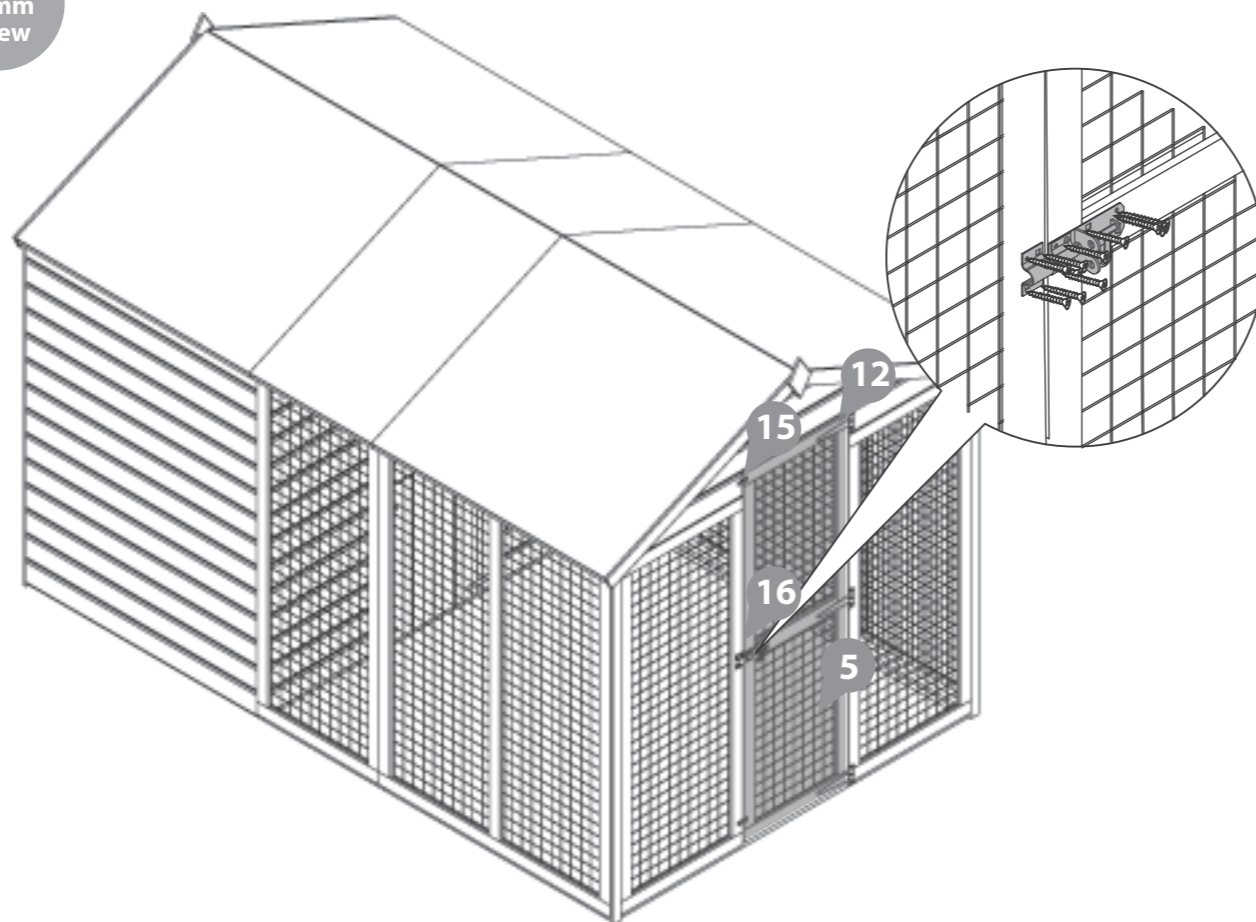

Step 17a

Finally, slot the flooring (**No. 9**) into the dog run.

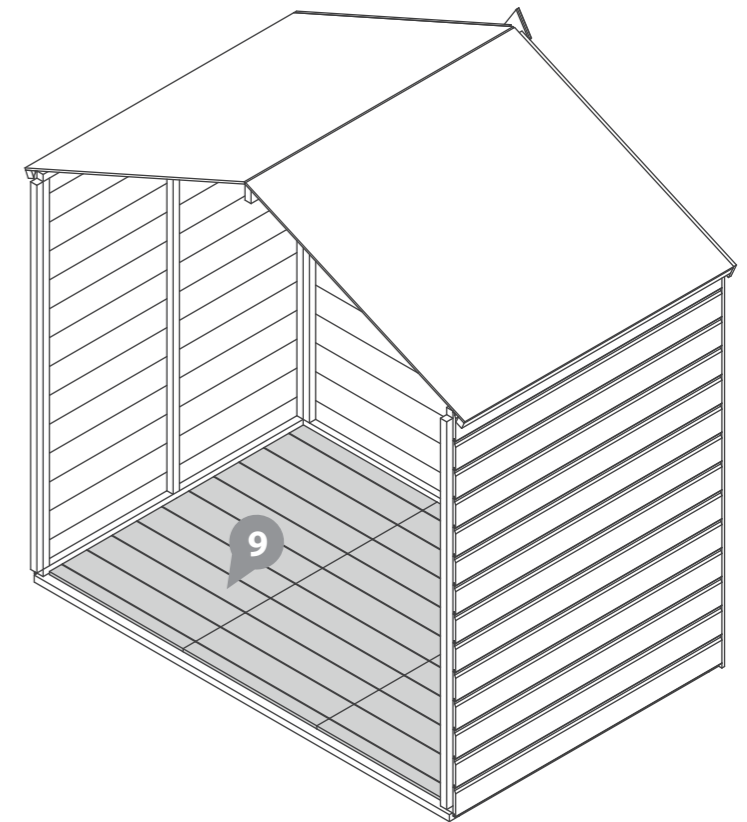

All our garden buildings have been designed and manufactured with care and attention to be the perfect addition to your outdoor space. To ensure you do get the best out of your new garden building and to increase the longevity we advise that you follow the product instructions and our manufacturer's recommendations as detailed below. Thank you for choosing a Mercia Garden product!

1 Choosing the most suitable location for your garden building...

A minimum of 60cm should be left around the perimeter of your garden building to allow access for maintenance, annual treatment and to allow air flow around the building.

Where possible you should avoid placing your garden building underneath large trees to prevent the tree causing damage to the building.

2 Preparing the base for your garden building...

All our buildings must be built on a firm, level base to ensure the longevity of the building and prevent the wood from distorting. We recommend either concrete, concrete slabs or a wooden base, such as our 'Portabase'.

The base should be slightly smaller than the external measurement of the building, i.e. the cladding should overlap the base, creating a run off for water and preventing water from pooling underneath the building.

We also recommend that the floor of the garden building is a minimum of 25mm above the surrounding ground level to avoid flooding.

3 After installation...

Once your garden building has been installed it will need to be treated as soon as possible and annually to prevent the timber from deteriorating and to waterproof it. This is required to maintain the anti-rot guarantee.

Dip Treated buildings - Require a preservative treatment to protect against rot and decay and a waterproof treatment to prevent water ingress

Pressure Treated buildings - Require a waterproof treatment to prevent water ingress

Log Cabins/Insulated Garden Rooms - Are supplied untreated and require a preservative and waterproofing treatment

We also recommend using a silicon sealant on the inside and outside of the windows as soon as possible after assembly and treatment to fully seal the windows.

Roofing felt/covering should be checked annually and replaced or fixed accordingly.

4 General maintenance and wood characteristics

As wood is a natural material it may be affected by the following:

Shrinkage and warping - The timber used in the construction of your garden building will have retained some of its natural moisture content. The moisture content of the timber will vary, depending upon prevailing environmental conditions, which will result in the components either naturally expanding or contracting. As the components dry out shrinkage may occur. A good waterproofing treatment from the start is the best protection to minimise the effect of moisture loss/intake.

In extended periods of very warm weather getting some moisture to the building will help the overall balance. You can do this by spraying it down lightly with a garden hose. In contrast after snow fall try to remove the snow as best as possible from the roof to prevent moisture intake and to remove the extra weight.

Top tip - using a garden brush will help you to reach the highest part of the building to remove snow and any debris left from bad weather.

Damp and mould - During the winter months, cold and damp conditions can result in an increased amount of moisture within your garden building, especially when used infrequently. Condensation can form on the timber and other items stored within your garden building. If left this moisture is likely to cause mould and mildew. To prevent the build-up of moisture, we recommend leaving the door or windows of your building open from time to time, to allow the fresh air to circulate. We also advise against storing wet or damp items in your garden building as this will also increase the level of moisture in the building. If mould or mildew does start to form within your building we recommend using an anti-mould cleaner to remove it and to prevent it spreading, which if left untreated could permanently damage your garden building.

Splits, cracks and knots - You may notice small splits and cracks in some components or holes may appear where knots shrink and fall out. This will not affect the structure of your Garden building however if you wish to fill them this can be easily done using any good quality wood filler.

Sap - is naturally occurring in wood and may appear in some boards of your garden building. If you wish to remove the sap, we advise waiting until it is dry and then using a sharp knife to carefully remove it. If the removal of the sap causes a hole in the timber, we recommend using a good quality wood filler to fill it.

For more handy hints and tips on how to care and maintain your garden building please refer to the MGP Customer Portal at www.mgplogistics.co.uk

Any further questions?

Contact our
Customer Service
Team on:
01636 821215

1 Manufacturer's Warranty

All Mercia Garden Products are supplied with a 1 year warranty on all parts against manufacturing defects.
This warranty does not cover movement, warping or splitting of timber products over time.

This warranty will be voided if any of the following occur:

1. The building has been customised or modified/adapted in any way.
2. The person claiming is not the original purchaser of the building.
3. Any damage has been caused by or as a result of misuse.
4. The building has not been maintained and cared for in accordance to our advisories and manufacturer's recommendations.
5. The building has not been treated annually or as per the manufacturer's recommendations, please ensure receipts are kept to validate this claim.
6. The building has not been erected, fitted or installed as per the supplier instructions.
7. The building has not been erected on a suitable sized firm flat, solid level concrete/slab base or placed on pressure treated bearers.
8. The building is or has been placed with 2 feet (60cm) of any obstructions (walls, trees, plants, fences etc.) which can allow moisture to penetrate the timber.
9. The roofing felt has been incorrectly fitted or damaged allowing water ingress, or not properly maintained.
10. Any windows and joints have not been sealed, inside and out, with silicone or other watertight sealant.
11. Any timber has been cut, pierced or drilled without subsequent application of approved cut-end treatment.

2 Anti-rot Guarantee

Mercia Garden Products offer a 10 year anti-rot guarantee on all dip treated (a preparatory treatment) and 15 years on all pressure treated products. This guarantee covers solid timber against rot, decay, blue stain and insect attack.

To validate the guarantee the building must be treated with a recognised wood preserver/water proof top coat (as detailed within manufacturer's recommendations) as soon as possible after assembly and annually thereafter.

This guarantee does not cover movement, warping or splitting of timber products over time.

This guarantee will be voided if any of the following occur:

1. The building has been customised or modified/adapted in any way.
2. The person claiming is not the original purchaser of the building.
3. Any damage is caused by or as a result of misuse.
4. The building has not been maintained and cared for in accordance to our advisories and manufacturer's recommendations.
5. The building has not been treated annually or as per the manufacturer's recommendations, please ensure receipts are kept to validate this claim.
6. The building has not been erected, fitted or installed as per the supplier instructions.
7. The building has not been erected on a suitable sized firm flat, solid level concrete/slab base or placed on pressure treated bearers.
8. The building is or has been placed with 2 feet (60cm) of any obstructions (walls, trees, plants, fences etc.) which can allow moisture to penetrate the timber.
9. The roofing felt has been incorrectly fitted or damaged allowing water ingress, or not properly maintained.
10. Any windows and joints have not been sealed, inside and out, with silicone or other watertight sealant.
11. Any timber has been cut, pierced or drilled without subsequent application of approved cut-end treatment.



REGISTER FOR YOUR
ANTI-ROT
GUARANTEE TODAY

PLEASE SCAN HERE:

