



# CB05

## User Guide

1602006 (230519)

# 1. Overview

Muzata CB05 is a beginner-friendly cable railing kit. With the swageless design, Muzata CB05 does not need the hydraulic crimper. You can install it by yourself easily. The T316 stainless steel makes it ideal for both indoor and outdoor uses, even coastal projects.

## 2. Specifications



<b>Model</b>	<b>Material</b>	<b>Size for wire rope</b>	<b>Surface treatment</b>
CB05	T316 stainless steel	1/8"	Plain/Black coated

### 3. Items related

Listed below are all of the accessories and tools related to the Muzata CB05. Please note that not all items are essential. Some may not be included in your package. If you need them, you may need to purchase them separately. Please select the appropriate color of the product according to the color design of your project.

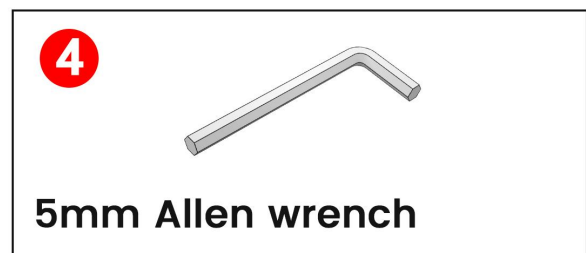
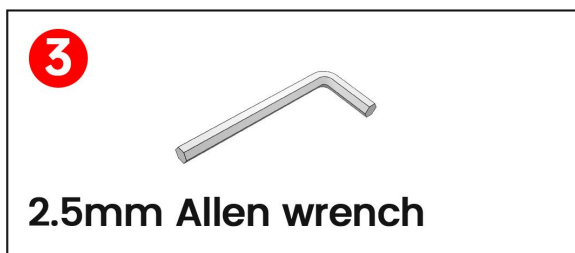
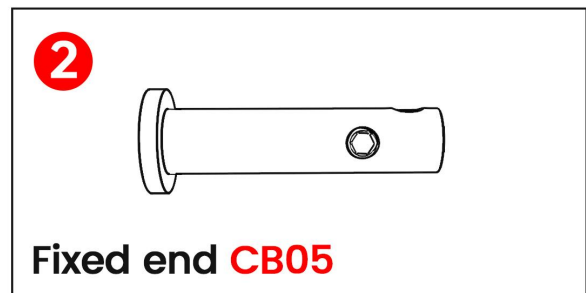
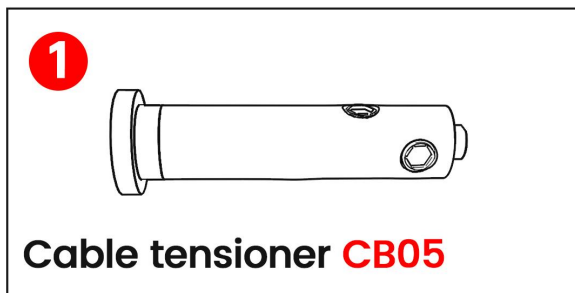

## 4. Installation steps

We will install the tensioner on the right end post as an example. Actually you can install it on either side according to your need.

### 4.1 For level railing

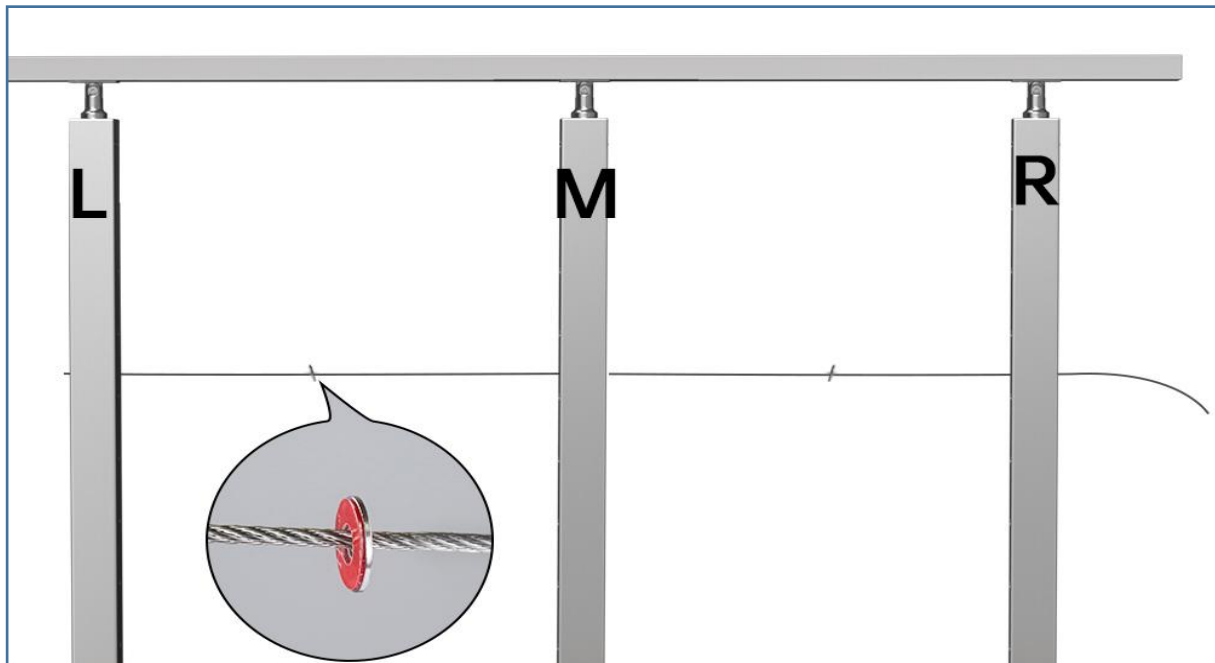

**Step 1** - Pass the cable from the right post to the left post, put in adhesive washer **7** for both L&R posts .

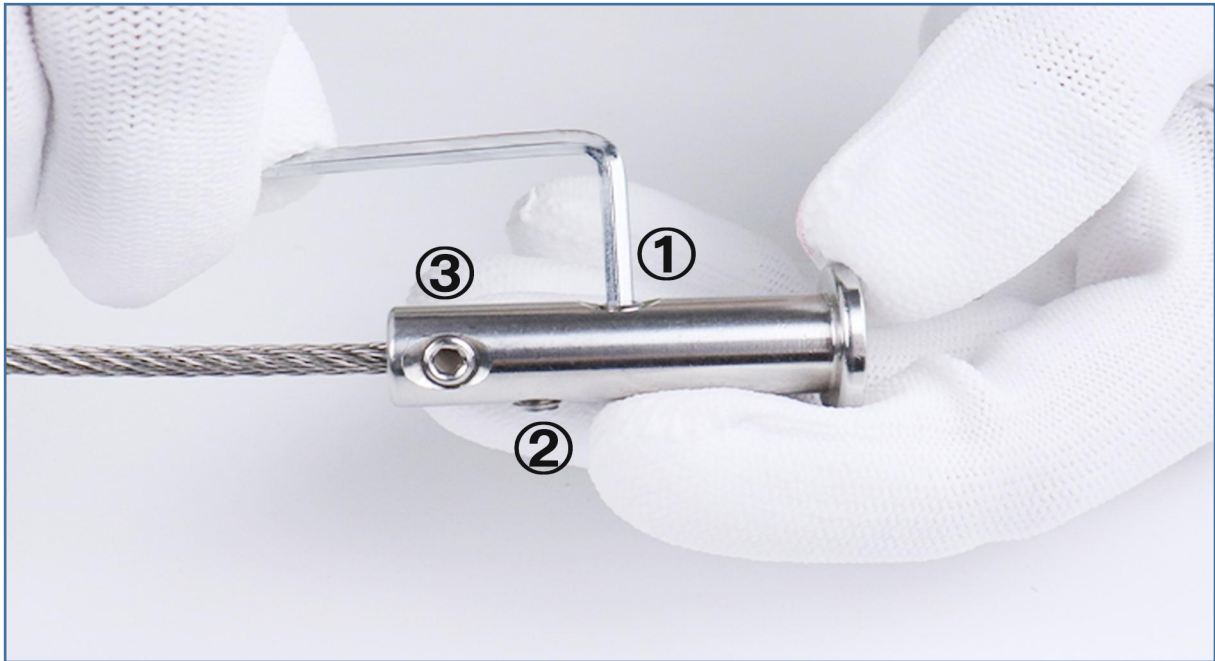

**Step 2** - Put the cable ⑤ into the fixed end ② and tighten the set screws in sequence with the 2.5mm Allen wrench ③.

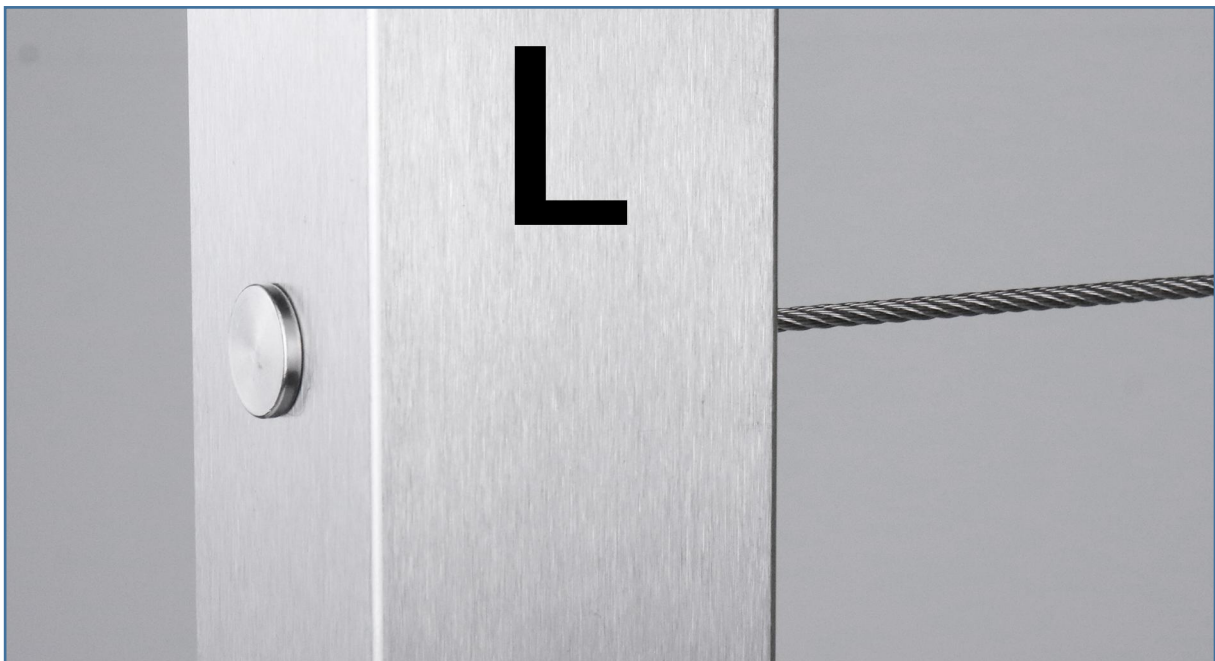

**Step 3** - Install the fixed end ② to the left end post.

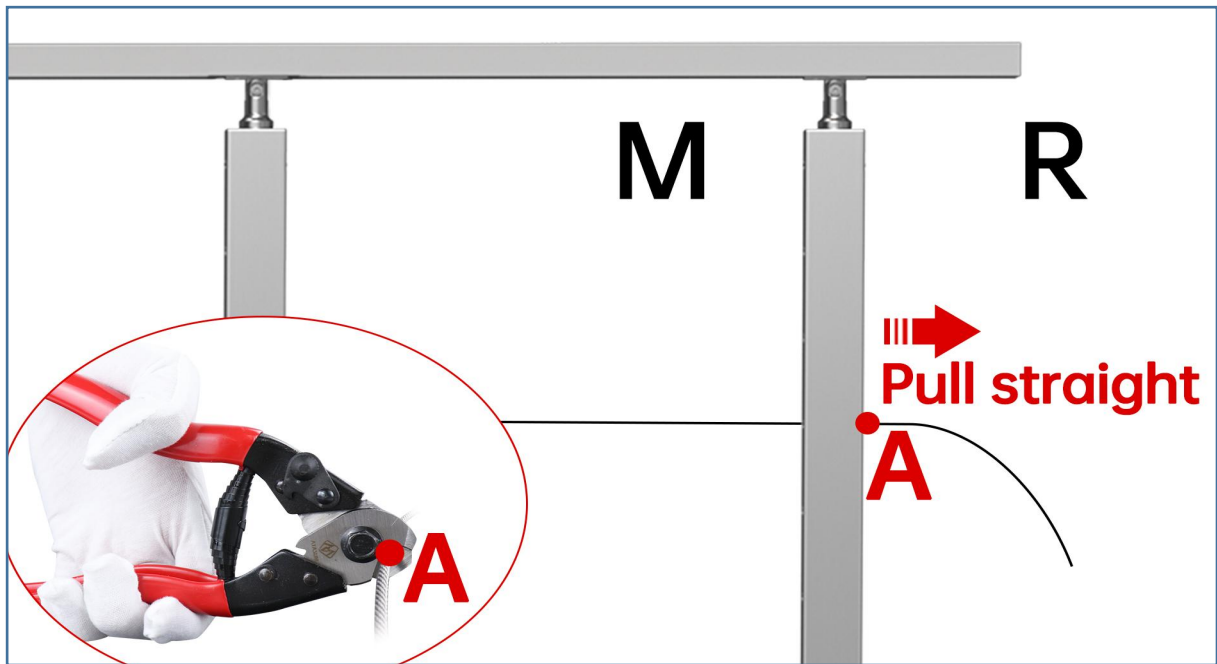

**Step 4** - Pull the cable against the right end post, mark point A from the outside of R post, and cut cable on point A with cable cutter ⑥.

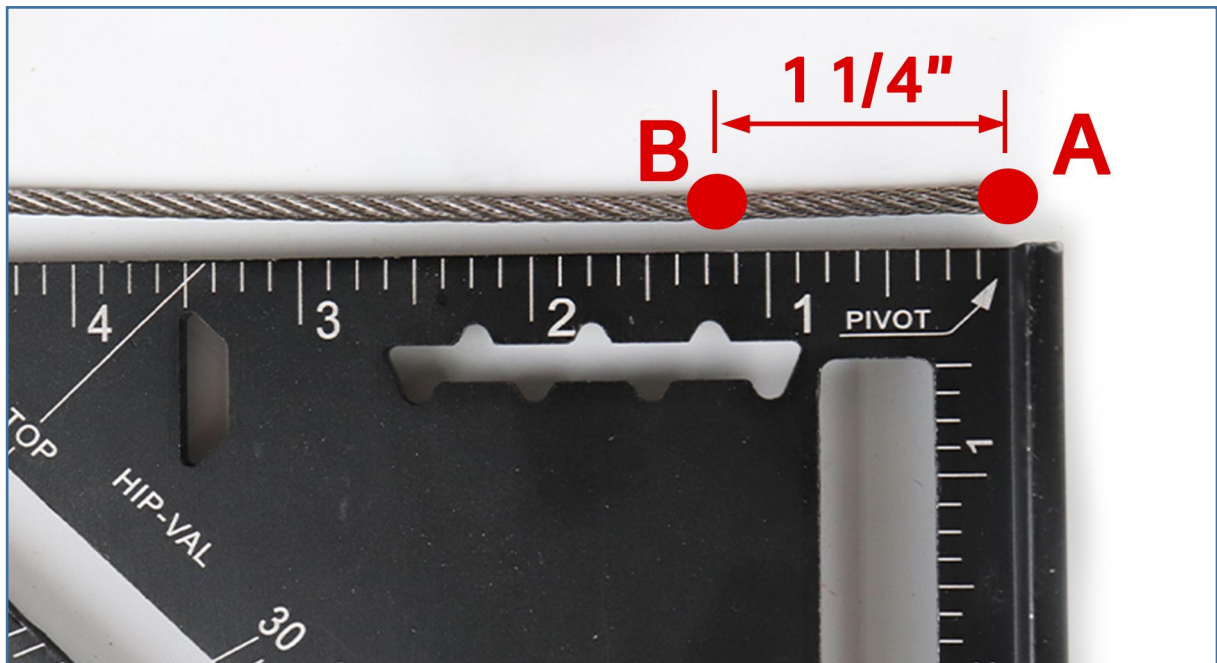

**Step 5** - Mark and cut at point B with cable cutter ⑥, which is 1 1/4" away from point A.





**Step 6** - Put the cable into the tensioner **1** and tighten the set screws in sequence with the 2.5mm Allen wrench **3**.

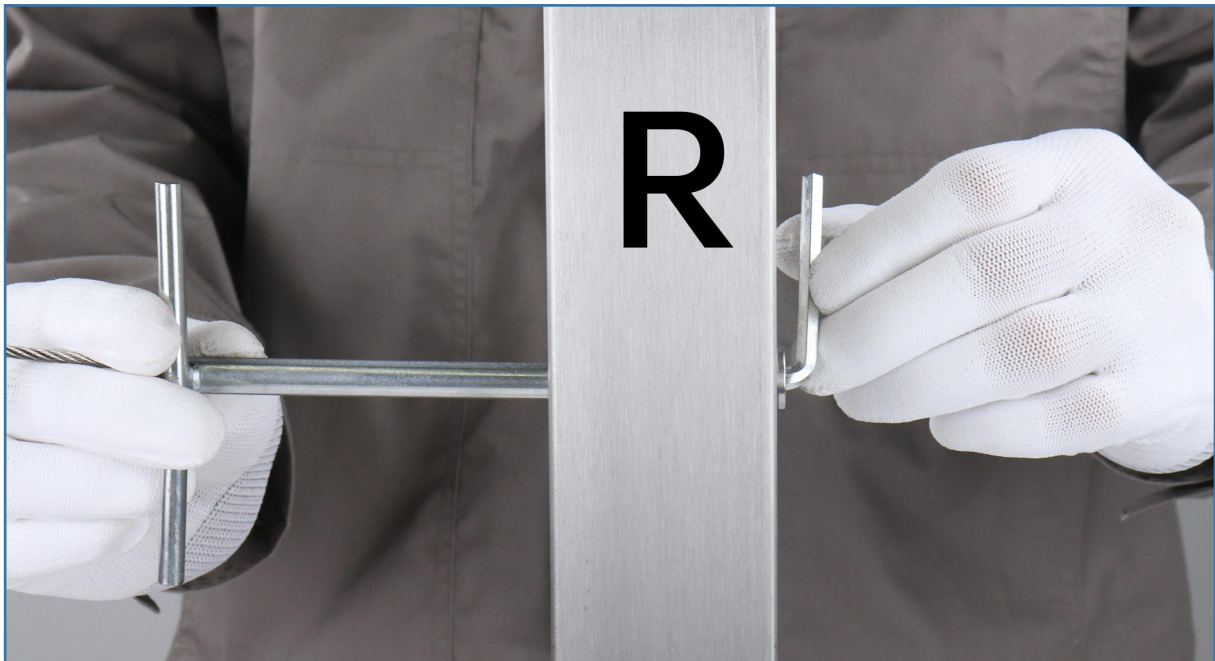

**Step 7** - Tighten the tensioner with socket wrench **9** and 5mm allen wrench **4** on the right end post.

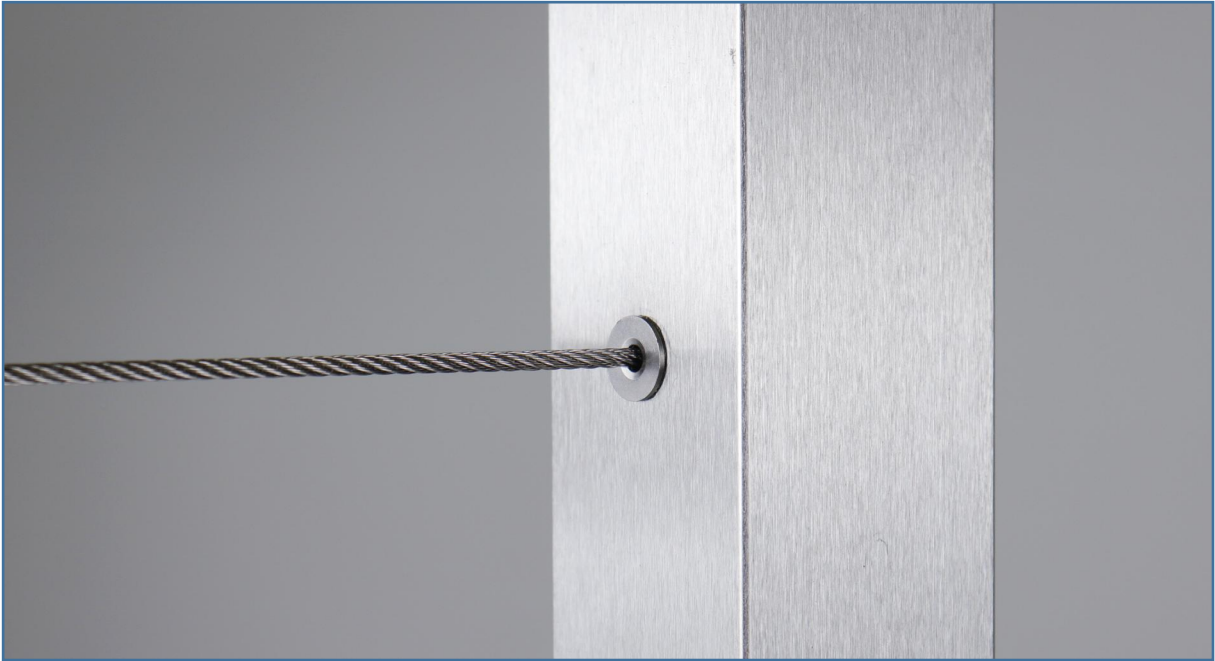

**Step 8** - Install the adhesive washers **7**.

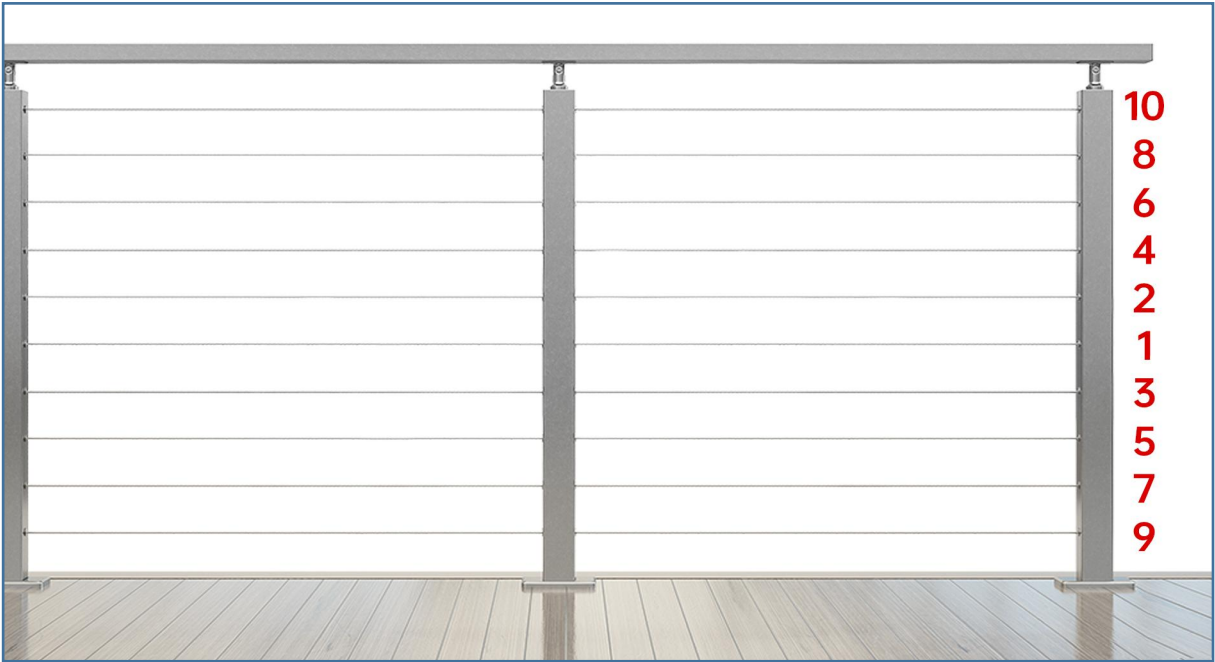

**Step 9** - Follow the sequence to install other cable runs.



## 4.2 For angle railing

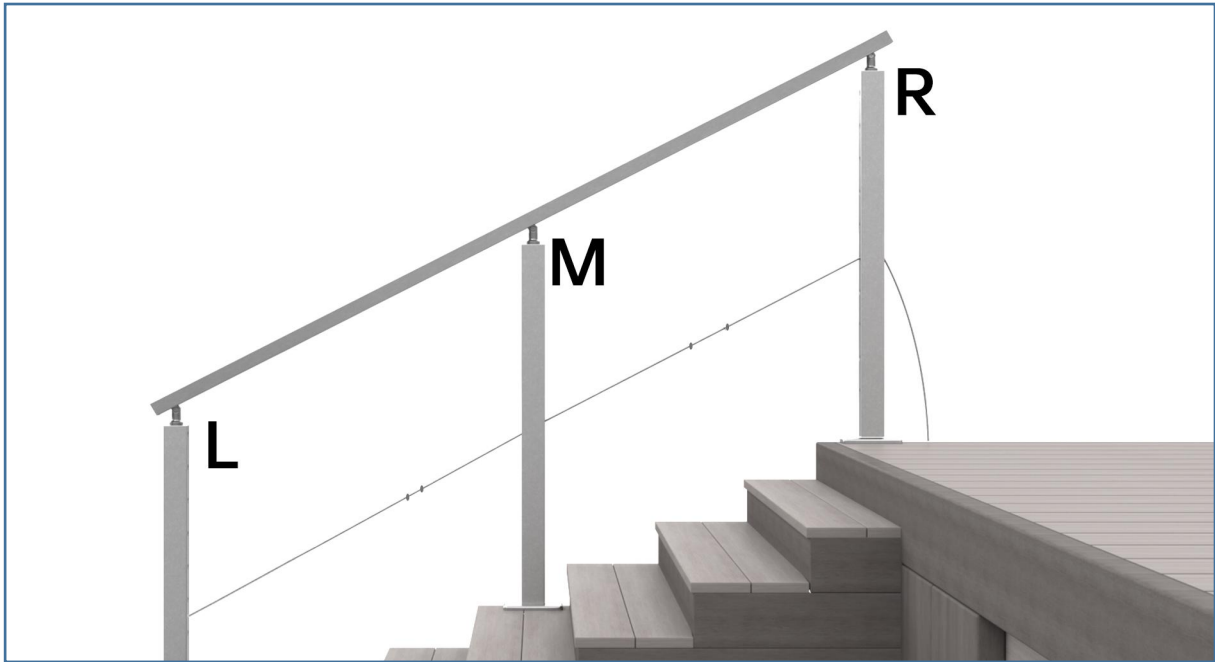

**Step 1** - Pass cable from the right post to the left post, put in adhesive washers **7** for both L&R posts, and angle protector sleeve **8** for middle posts.



**Step 2** - Put in angle washer **10** before tightening the set screws in sequence with the 2.5mm allen wrench **3**.

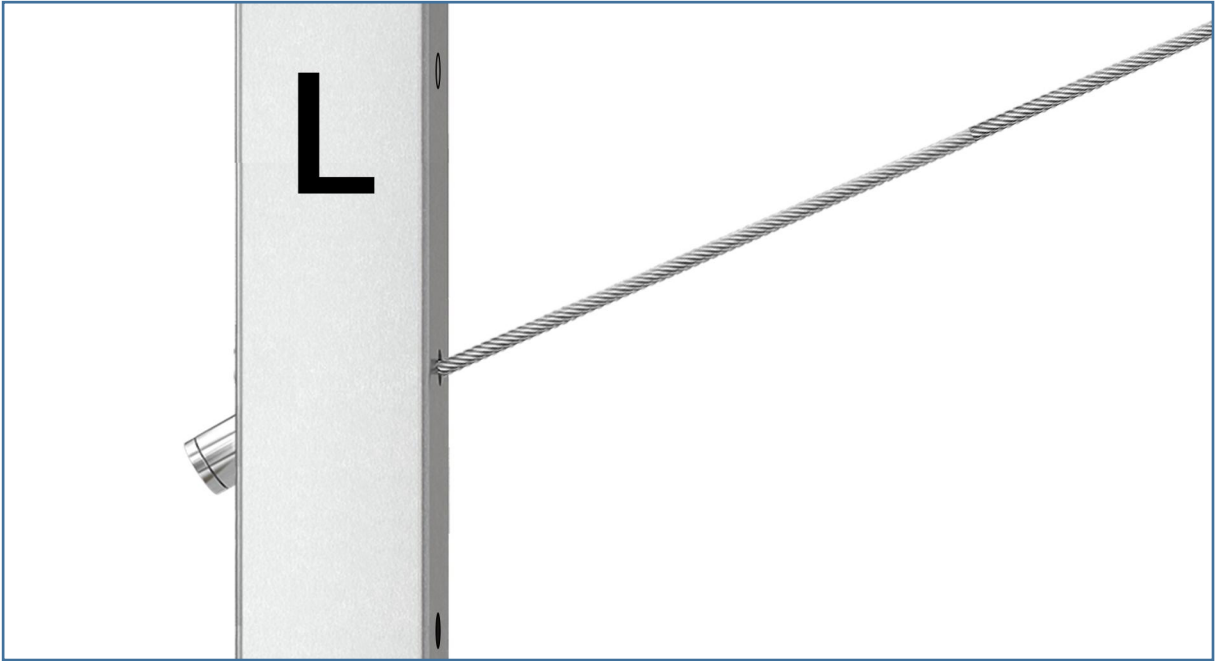

**Step 3** - Install the fixed end ② to the left end post.

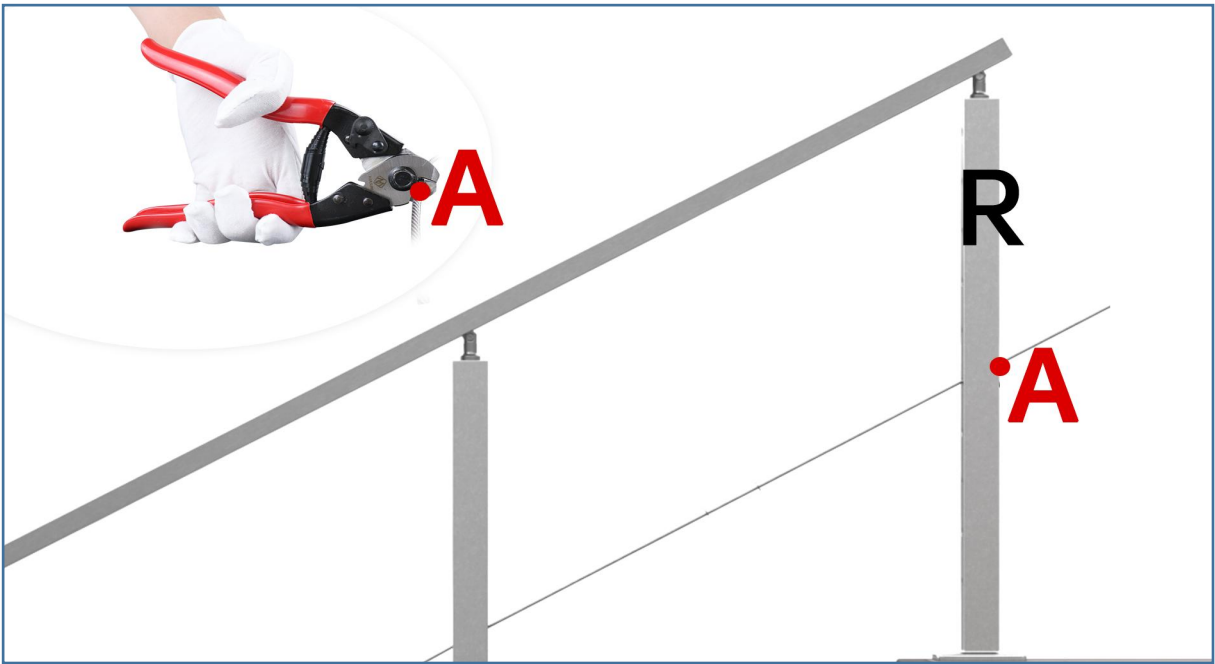

**Step 4** - Pull the cable against the right end post, mark point A from outside of the right post, and cut cable on point A with cable cutter ⑥.

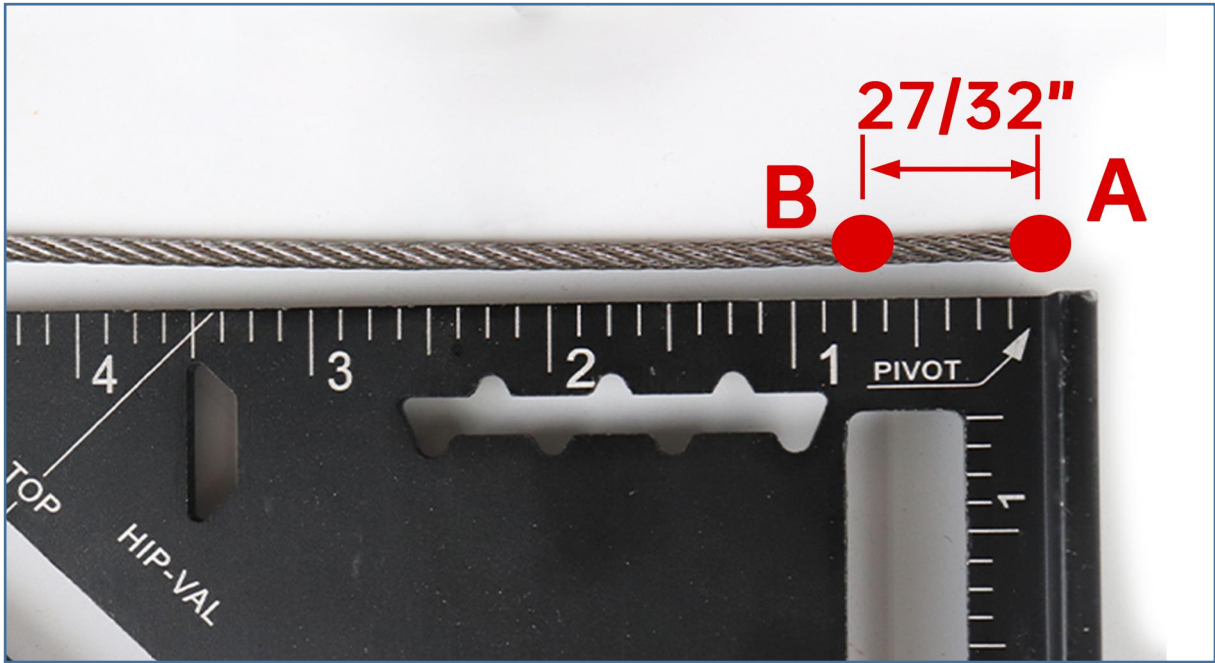

**Step 5** - Mark and cut at B, which is  $27/32''$  away from point A, with cable cutter **6**.



**Step 6** - Put the cable into the tensioner **1** and tighten the set screws in sequence with 2.5mm allen wrench **3**.

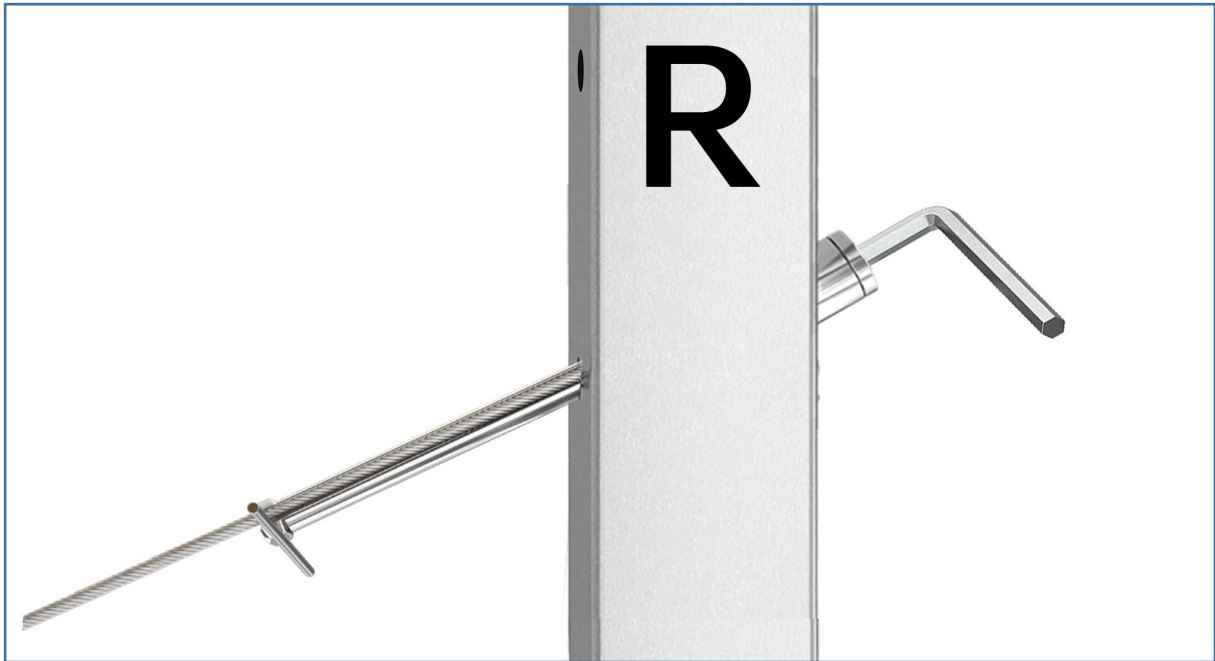

**Step 7** - Put in angle washer **10** before tightening the tensioner **1** with socket wrench **9** and 5mm allen wrench **4** on the right end post.

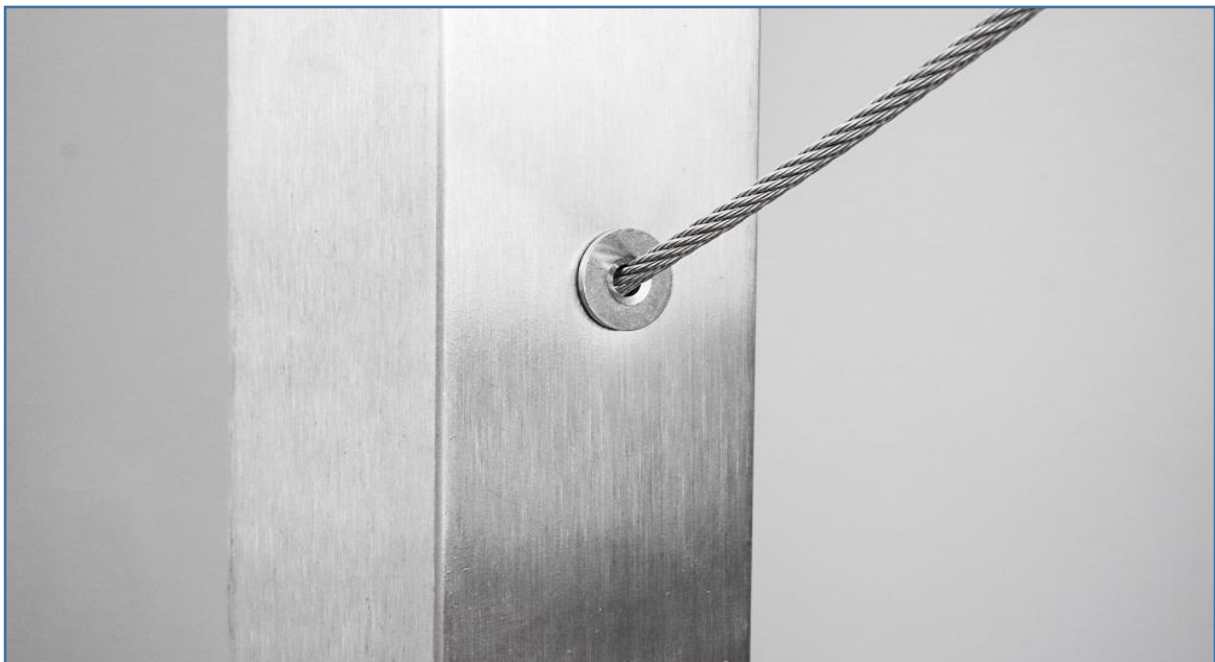

**Step 8** - Install adhesive washers **7**.



**Step 9** - Follow the sequence to install other cable runs.

Please note that installation videos are available on our product pages for further details if needed.



## 5. Tips

(1) Ensure that your posts and handrail are properly installed before you start cable installation.

(2) You might have to buy a few more materials than expected in case some materials might not be reusable after operation mistakes.

(3) The recommended post spacing between two posts is 3ft-4ft, no more than 4ft. For our 6'6" handrails, it would be best to adopt 3'3" post spacing.

(4) The overall height of the railing, which is the structure of the post and handrail, should be equal to or higher than 36" to meet the residential building codes of most states.

(5) 3" cable spacing and 200 lbs tension on each cable line are recommended to pass the 4" sphere test (required by most states). You can buy a tension gauge online or from local stores.

## 6. Free design service

We offer custom cable railing design services for free. If you are a beginner or not sure about how to do it, please reach us. Our experts can do all the planning, designing, and budget work for you without extra charge.

## 7. About Muzata

MUZATA has helped millions of families with their cable railing projects during the past years. We believe that home renovation should be easy and affordable. So we work with every effort to provide quality products and professional service, to make Muzata a reliable brand.