

CT24

User Guide

1. Overview



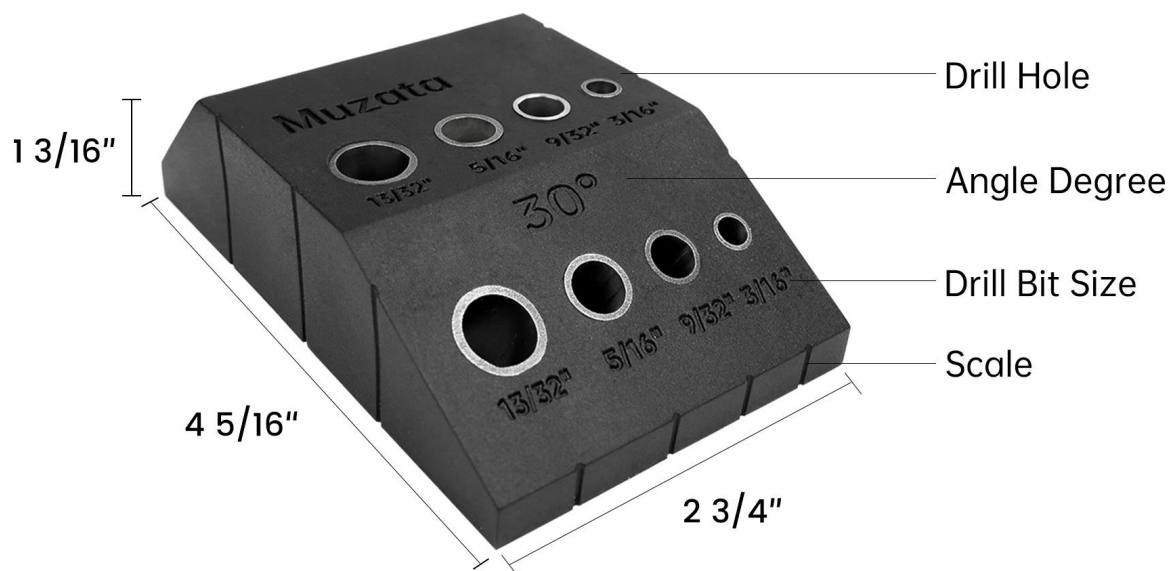

Muzata CT24 is a drill guide designed with three drilling angles. It offers 30, 45, and 90 degree angles for straight and angled holes. It fits four different sizes of drill bits that are compatible with most cable railing kits. This drill guide upgrades with scales in two directions to ensure precise positioning of the drilling holes. The drill guide is made of nylon and embedded with T304 stainless steel sleeves, making it lightweight and durable.

2. Specifications



Model	Material	Angle application	Hole size
CT24	Guide Body: Nylon Sleeves: T304 stainless steel	30°	11mm
		45°	8.5mm
		7.5mm	
		90°	5mm

3. Matched drill bit (Not included)

Model	Suitable drill bit	Drill bit size
①		13/32"
②		5/16"
③		9/32"
④		3/16"

4. Instructions

It is designed for cable railing systems and allows you to choose the right drill bit and holes as needed to install your project.

4.1 Operation steps

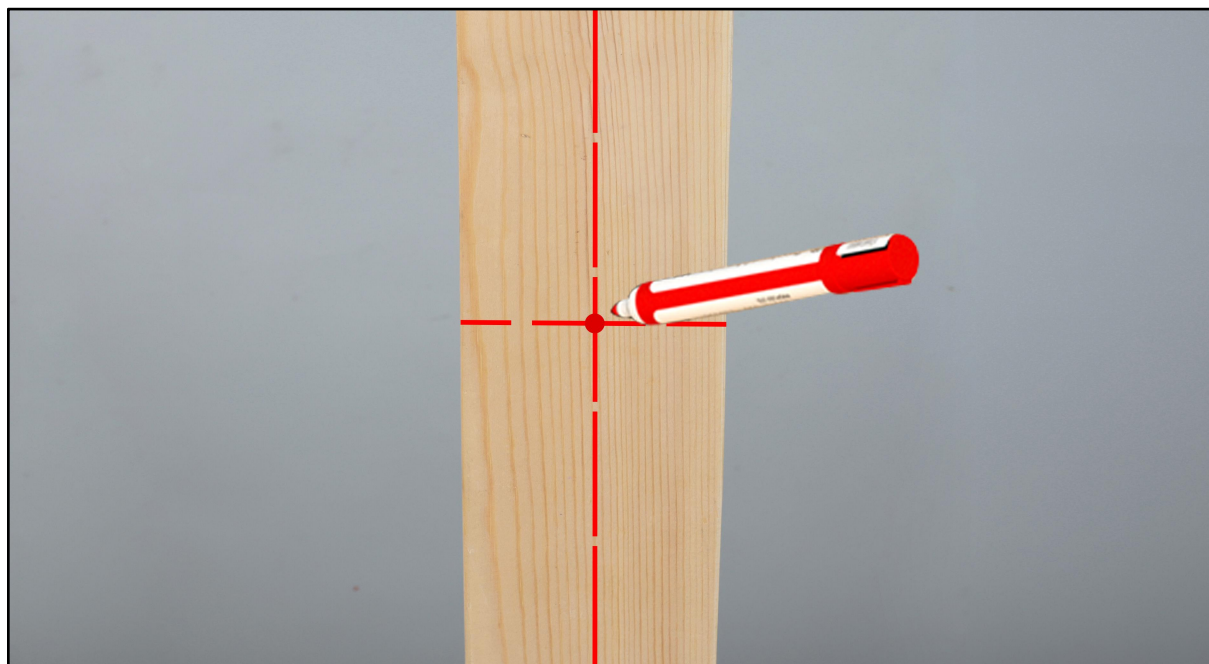

Step 1 - Draw cross lines and then mark the drilling point.

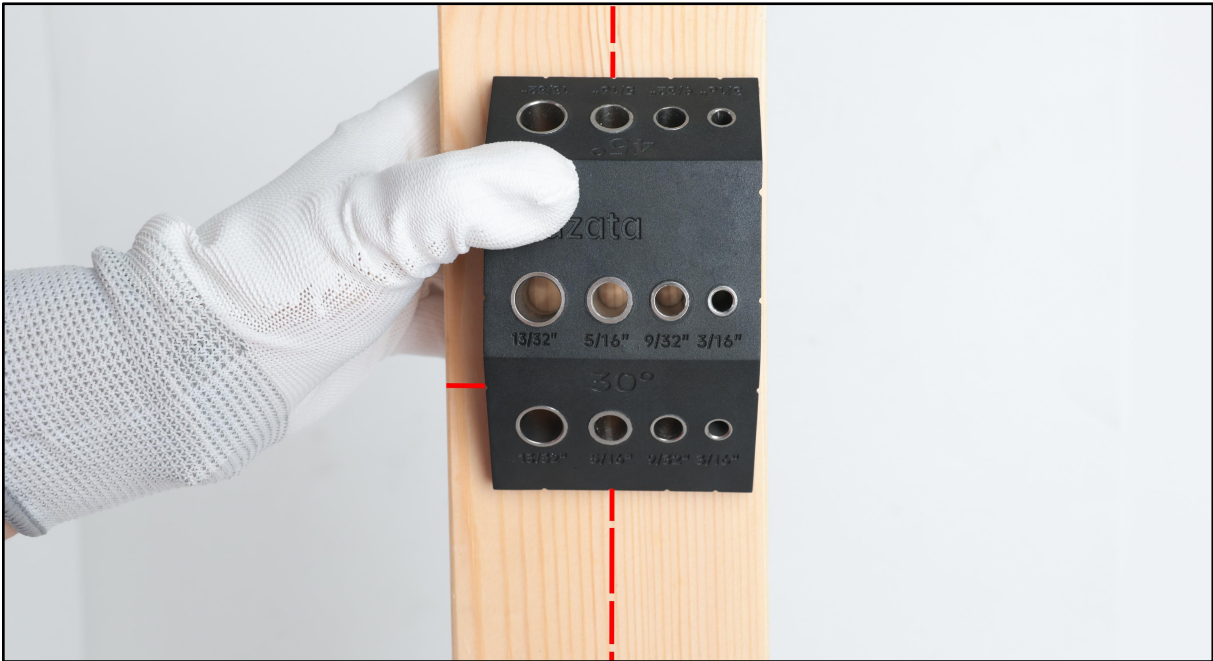

Step 2 - Align with the scales for accurate drilling.

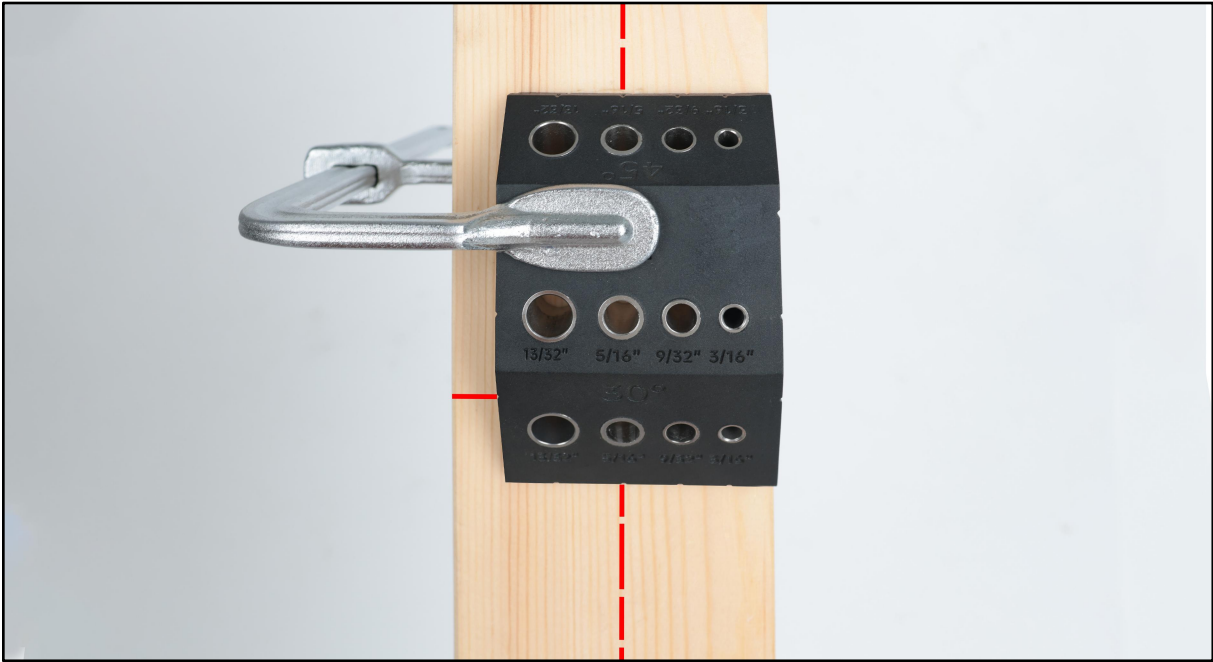

Step 3 - Fix the Drill Guide with F clamp.

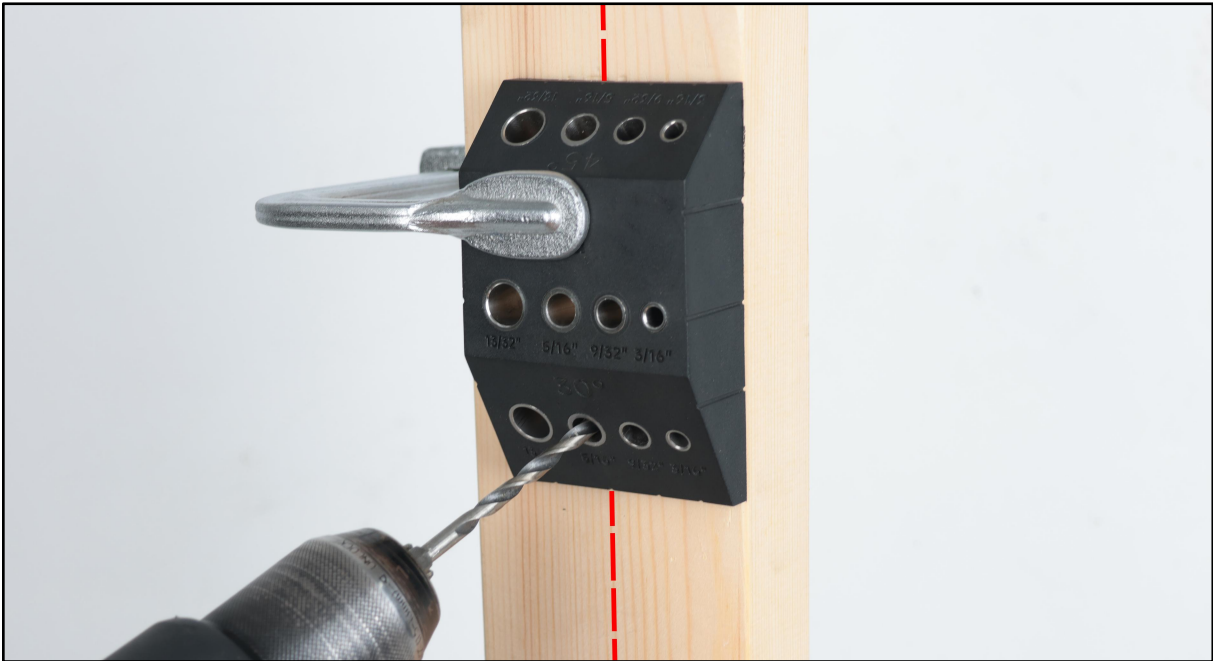

Step 4 - Choose the right drill bit and drill the holes.

4.2 Application of drilling holes at different angles



(30° for drilling angle post)

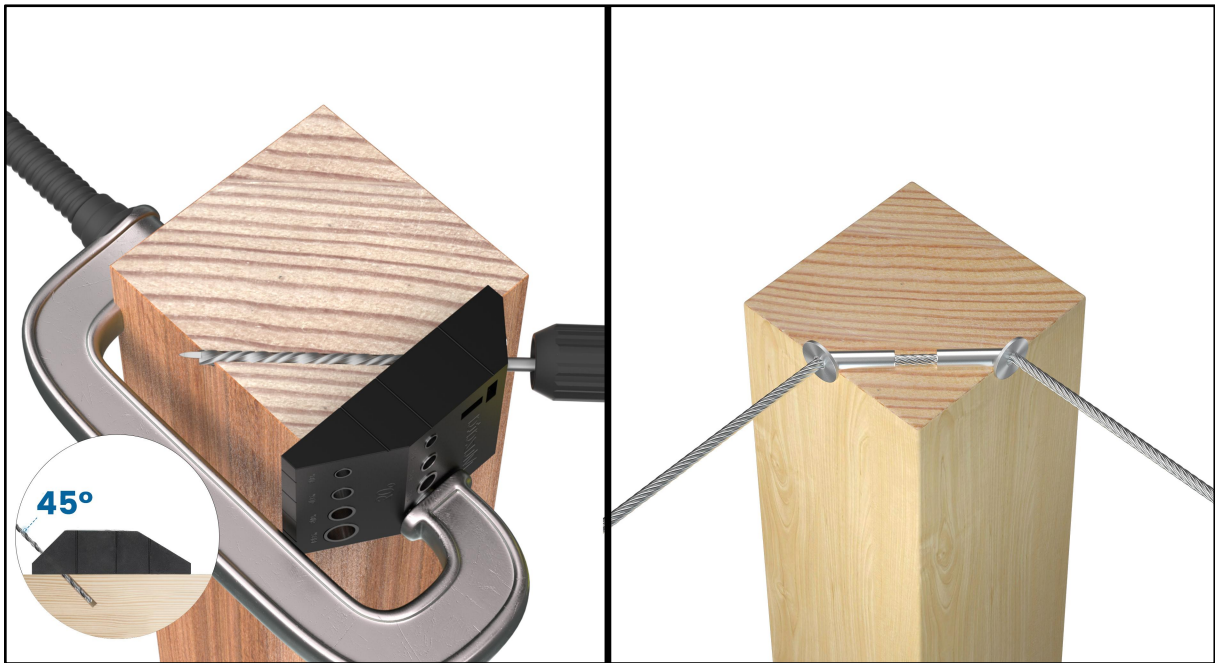

(45° for drilling corner post)



(90° for drilling level post)

5. Common applications with Muzata cable railing kits



Please note that installation videos are available on our product pages for further details if needed.

6. Tips

- (1) When you mark the drilling positions, the marking lines should be extended to the outside of the drill guide for alignment with the guidelines.
- (2) Ensure that the clamp fixes the drill guide steadily for precise positioning.
- (3) Please choose the right drill bit and appropriate speed to get the best drilling effect.
- (4) Please prevent the drill guide from collision or dropping to prolong its service life.

7. Free design service

We offer custom cable railing design service for free. If you are a beginner or not sure about how to do it, please reach us. Our experts can do all the planning, designing and budget work for you without extra charge.

8. About Muzata

Muzata has helped millions of families with their cable railing projects during the past years. We believe that home renovation should be easy and affordable. So we work with every effort to provide quality products and professional service, to make Muzata a reliable brand.

Follow us



@Muzata railing



@muzata_official



@muzata_official



@muzata_official