

AMD LASERS®

Effective. Practical. Affordable. World Class Lasers.











Operating Instructions Manual

PICASSO PLUS & PICASSO LITE PLUS

English - Version 1.0

**PICASSO PLUS | PICASSO LITE PLUS
OPERATING INSTRUCTIONS MANUAL**

SYMBOL	DESCRIPTION
 Do Not Throw Away	Do Not Throw Away Consult with local laws with respect to medical equipment disposal.
	Laser Danger
 Non-autoclavable	Do Not Autoclave
 Single Use Only	Single Use Only
 Consult Instructions For Use	Consult Instruction For Use
 Exp Date	Expiration Date
	Manufactured for AMD LASERS 7405 Westfield Blvd. Indianapolis, IN 46240 USA
	Fragile, handle with care
Rx Only	Only Applicable for USA









SYMBOL	DESCRIPTION
 Type B Applied Part	Type B Applied Part
	Warning Label
 Class II Equipment	Class II Equipment
	Must Read Manual Prior to Use
	Battery Symbol with Polarity
	Optical Fiber
	Manufactured Date
	Standby/Ready Button
	Protection Against Vertically Falling Drops of Water (e.g. Condensation)

TABLE OF CONTENTS

PICASSO PLUS PICASSO LITE PLUS OPERATING INSTRUCTIONS MANUAL	1
TABLE OF CONTENTS	3
INTRODUCTION	5
SAFETY INFORMATION	5
SAFETY PRECAUTIONS	5
SAFETY INSTRUCTIONS	6
SAFETY FEATURES	7
WIRELESS FOOT CONTROL COMPLIANCE	8
IC: RSS-GEN:	9
CONTENTS OF PICASSO Plus & PICASSO LITE Plus	10
MAIN UNITS: PICASSO PICASSO LITE – FIGURE 1	11
INDICATIONS FOR USE	12
LASER PERIODONTAL PROCEDURES	12
TEETH WHITENING INDICATIONS (PICASSO PLUS ONLY)	12
SET-UP INFORMATION	13
PICASSO PLUS AND PICASSO LITE PLUS SET-UP	13
OPERATION INSTRUCTIONS	13
CONTROL PANEL Picasso Plus Picasso Lite Plus – FIGURE 2	14
WIRELESS FOOT CONTROL	17
Instruction for Use	17
WARNINGS	17
PRECAUTIONS	18
STEP-BY-STEP INSTRUCTIONS	19
MULTI-TIP HANDPIECE WITH FIBER	19
STRIPPABLE FIBER WITH SURGICAL HANDPIECE	21
PICASSO+ PICASSO LITE+ MODES	26
PRODUCT SPECIFICATION	27
GENERAL	27
ELECTRICAL	27
LASER – PICASSO PLUS (Model P810)	27
OTHER LIGHT SOURCES	28
LASER – PICASSO LITE PLUS (Model PL810)	28
INSTRUCTION FOR ACCESSORIES	29
INITIATING TIP	29
TEETH WHITENING (PICASSO PLUS ONLY)	29
MAINTENANCE	30
DENTAL LASER UNIT AND PLASTIC BARRIERS MAINTENANCE	30
ANNUAL MAINTENANCE	30
TRANSPORTATION	31
FOOTSWITCH BATTERY REPLACEMENT	31
ENVIRONMENTAL PROTECTION	31
CALIBRATION PROCEDURE	32
CALIBRATION SCHEDULE	32
ERRORS AND WARNINGS	33

Remote Interlock Error	33
Low Foot Switch Battery Error	33
Internal Fault – Service Required Error	34
High Laser Module Temperature Error	35
Check Optical Fiber Connection Error	35
Calibration Required Error	36
ELECTROMAGNETIC COMPATIBILITY (EMC)	37
ANNEX A: LABELS	41
Footswitch labels	43
ANNEX B: Accessories	44
AMD LASERS: TERMS AND CONDITIONS OF SALE	46
SHIPPING AND HANDLING	46
GOVERNING LAW, CONSENT TO JURISDICTION AND VENUE OF LITIGATION	46
ELECTRONIC SIGNATURES	46
RETURNS	46
WARRANTY	46
OTHER	47
LIMITED LIABILITY	48

INTRODUCTION

The Picasso line of soft tissue dental lasers is designed for a wide variety of oral soft tissue and teeth whitening procedures. Picasso Plus & Picasso Lite Plus (also referred to as Picasso+ and Picasso Lite+ herein) employ solid-state diodes as a laser energy source. The energy is delivered to the operating area by means of a delivery system consisting of a flexible fiber connecting the laser source and the handpiece. The device is activated by means of a wireless footswitch.

Picasso Plus and Picasso Lite Plus lasers are intended for use by dentists, hygienists and/or authorized dental professionals on oral soft tissue as defined by the “Indications for Use.” The Picasso Laser may also be used in teeth whitening procedures. The use of these devices requires proper clinical and technical training. This manual provides instructions for professionals that have completed the appropriate training.

When used and maintained properly, Picasso Plus and Picasso Lite Plus lasers will prove to be a valuable addition to your practice. Please contact your authorized representative or AMD LASERS® if you have any questions or require assistance.

SAFETY INFORMATION

SAFETY PRECAUTIONS

DANGER: LASER RADIATION – AVOID EYE OR SKIN EXPOSURE TO DIRECT OR SCATTERED RADIATION!

WARNING: TO AVOID RISK OF ELECTRIC SHOCK, AC/DC ADAPTER MUST ONLY BE CONNECTED TO A PROPERLY GROUNDED POWER SOURCE!

The user should read and be thoroughly familiar with this manual before operating this dental diode laser. The equipment should be routinely inspected and maintained in accordance with the instructions given in the maintenance section of this manual.

CAUTION: USE OF CONTROLS OR ADJUSTMENTS OR PERFORMANCE OR PROCEDURES OTHER THAN THOSE SPECIFIED HEREIN MAY RESULT IN HAZARDOUS RADIATION EXPOSURE.

Unauthorized accessories not provided by the manufacturer may result in potential hazard.

All clinical procedures performed with Picasso Plus and Picasso Lite Plus must be subjected to the same clinical judgment and care as traditional techniques. Patient risk must always be considered and fully understood before clinical treatment. The clinician must completely understand the patient’s medical history prior to treatment. Exercise caution for general medical conditions that might contraindicate a local procedure. Such conditions may include allergy to local or topical anesthetics, heart disease, lung disease, bleeding disorders, sleep apnea, or an immune system deficiency. Medical clearance from a patient’s physician is advisable before treatment.

WARNING: Nominal Ocular Hazard Distance (NOHD) is 2m from the distal end of the fiber to avoid eye or skin exposure to direct or scattered radiation.

WARNING: To avoid eye or skin exposure to direct or scattered radiation, do not use the Picasso Plus or Picasso lite Plus without the appropriate tip for the procedure being performed.

Note: Laser equipment not in use should be protected against unauthorized use by removal of the key from the key switch.

Note: Opening this unit or adjusting components inside the unit will void the warranty since such actions may compromise the performance of the laser system.

WARNING: To prevent device damage, use only the power supply provided with the system or provided by AMD LASERS.

Failure to comply with the stated precautions and warnings may lead to exposure to electrical shock and/or exposure to radiation sources. Please comply with all safety instructions and warnings. Picasso Plus and Picasso Lite Plus have been tested and have been found to be compliant with the latest electrical safety standard (IEC60601-1 3rd edition).

SAFETY INSTRUCTIONS

WARNING: Use of accessories and cables other than those specified or provided by the manufacturer of this equipment could result in increased electromagnetic emissions or decreased electromagnetic immunity of this equipment, resulting in improper operation.

WARNING: Portable RF communications equipment (including peripherals such as antenna cables and external antennas) should be used no closer than 30 cm (12 inches) to any part of the laser, including cables attached to the laser. Otherwise, degradation of the performance of this equipment could result.

Follow these safety instructions before and during treatments:

- All operatory entrances must be marked with the appropriate danger warning sign.
- Do not operate the laser in the presence of explosive or flammable materials.
- Near infrared light (810 nm) from the laser can pass through the transparent components of the unprotected eye and is focused on the retina at the back of the eye. This can cause permanent retinal burns and blindness. Patients and operating room personnel should wear protective eyewear with an optical density (OD) of at least 5+ in the range of 800–820 nm during all procedures.
- Do not position the laser such that it is difficult to disconnect the electrical plug from the wall or disconnect the power input connector from the back of the unit.

CAUTION: PERIODICALLY INSPECT EYEWEAR FOR PITTING AND CRACKING.

NOTE: For replacement, additional or prescription protective eyewear, please contact your authorized service representative or AMD LASERS®.

- Do not look directly into the beam or at specular reflections.
- Never direct or point the beam toward the eyes.
- Remove or cover all highly reflective items in the treatment area.

- Press STANDBY on the control panel before turning the unit off.
- Always press STANDBY on the control panel before exchanging handpieces or removing the fiber optic connector from the unit.
- Move the circuit breaker (located on rear panel) to the OFF (0) position, remove the key, and place it in a secure location before leaving the unit unattended.
- Remove all obstructions from the cooling vents on the device to ensure proper air flow and cooling of the device.

Safety Classification

The following safety classifications are applicable to the Picasso Plus and Picasso Lite Plus devices:

- Laser Radiation: Class 4 (working beam)
- Type of electrical shock protection: Class II
- Degree of electrical shock protection: Type B Applied Part (handpiece)
- Laser not protected against water ingress: Ordinary Equipment
- Not suitable for use in the presence of flammable anesthetic mixtures
- Operation Mode: See Specifications

Safety Questions

Please direct safety questions to an authorized representative or directly to AMD LASERS.

SAFETY FEATURES

Circuit Breaker

Serves as a line switch to separate the unit from the main power supply: 0 = OFF, | = ON.

System Monitor

The system monitors the emergency stop switch, remote interlock, footswitch attachment, fiber attachment, and output power. Any detected error will stop the system.

Keyswitch

The unit can only be switched ON (key in horizontal position) with the proper key. Always turn the unit OFF (vertical position) and remove the key when not in use.

STANDBY/READY Button

Once the circuit breaker and keyswitch are set to the ON position, the STANDBY/READY button on the keypad must be pressed to enable the footswitch. One beep will sound and the STANDBY button will turn green in the READY mode. There is a 2-second delay between pressing of the ready button and laser entering READY mode which, upon pressing the footswitch, allows for laser emission. The aiming beam will be blinking during the 2-seconds and then go solid when unit entered READY mode (unless turned off by the operator). Aiming beam will be OFF in STANDBY mode.

Footswitch

No laser energy will be emitted until the user presses down on the footswitch. The footswitch features a spring-loaded cover.

Emergency Stop

Press the red Emergency Stop button to instantly turn off the unit. The button will be in the out position. To reset the Emergency Stop button, simply press again. The button will be in the pushed in position for normal operation. Only use the Emergency Stop for emergencies.

Remote Interlock (Optional)

The remote interlock feature allows the user to connect the laser to an operatory door trigger to disable the laser when the door is opened. Please consult a qualified electrician to perform the proper wiring from the Remote Interlock Connector/Plug to the operatory door. The remote interlock plug does not need to be inserted for normal operation. The remote interlock connector is attached by pushing it into place. Removal is accomplished by sliding the portion of the connector closest to the laser housing away from the laser.

Audible and Visual Display

The laser will give an audible beep and flash a light within the ready button while the laser is firing. The audible sound may be adjusted by the user but may not be turned off completely. The visual display may not be turned off.

Functional Display

The LCD Display on the front of the unit shows the functional conditions of the system.

WIRELESS FOOT CONTROL COMPLIANCE

	Mod.: XBee	Frequency: 2.4G Hz
	FCC ID: OUR-XBEE/CB-0925	Voltage: 9 Volts DC
	IC: 4214A-XBEE/5325A-0925	9V Alkaline Batteries Only

FCC:

15.19 (a) (3):

This device complies with Part 15 of the FCC Rules. Operation is subject to the following two conditions: [1] this device may not cause harmful interference, and [2] this device must accept any interference received, including interference that may cause undesired operation.

15.21:

The user's manual or instruction manual for an intentional or unintentional radiator shall caution the user that changes or modifications not expressly approved by the party responsible for compliance could void the user's authority to operate the equipment.

15.105:

For a Class B digital device or peripheral, the instructions furnished the user shall include the following or similar statement, placed in a prominent location in the text of the manual.

NOTE:

This equipment has been tested and found to comply with the limits for a Class B digital device, pursuant to Part 15 of the FCC Rules. These limits are designed to provide reasonable protection against harmful interference in a residential installation. This equipment generates uses and can radiate radio frequency energy and, if not installed and used in accordance with the instructions, may cause harmful interference to radio communications. However, there is no guarantee that interference will not occur in a particular installation. If this equipment does cause harmful interference to radio or television reception, which can be determined by turning the equipment off and on, the user is encouraged to try to correct the interference by one or more of the following measures:

- Reorient or relocate the receiving antenna.
- Increase the separation between the equipment and receiver.
- Connect the equipment into an outlet on a circuit different from that to which the receiver is connected.
- Consult the dealer or an experienced radio/TV technician for help.

IC: RSS-GEN:

7.1.2 Transmitter Antenna

WARNING: Do not modify this equipment without written authorization of the manufacturer.

Canada Only: This device should be installed and operated in accordance with CAN/CSA-Z386-92: Laser Safety in Health Care Facilities.

Information in this document is subject to change without notice. User manuals for transmitters shall display the following notice in a conspicuous location:

Under Industry Canada regulations, this radio transmitter may only operate using an antenna of a type and maximum (or lesser) gain approval for the transmitter by Industry Canada. To reduce potential radio interference to other users, the antenna type and its gain should be so chosen that the equivalent isotropically radiated power (e.i.r.p.) is not more than that necessary for successful communication.

7.1.3 User Manual

User manuals for license-exempt radio apparatus shall contain the following or equivalent notice in a conspicuous location in the user manual or alternatively on the device or both.

This device complies with Industry Canada license-exempt RSS standard(s). Operation is subject to the following two conditions:

[1] this device may not cause interference, and [2] this device must accept any interference, including interference that may cause undesired operation of the device.

CONTENTS OF PICASSO PLUS & PICASSO LITE PLUS

#	ITEM	DESCRIPTION
1	Handpiece & Holder, Disposable Tip	Multi-Tip Handpiece/Fiber with Fiber Spool, Holder, & Disposable Tip
2	Handle	For Transporting the Unit
3	Fiber Spool	Stores Fiber
4	Emergency Stop Button	Disables the Unit In the Event of an Emergency
5	Control Panel	Displays & Controls the Parameters (e.g. Power Output, Presets, Aiming Beam & Intensity, & Speaker Volume)
6	Fiber Connector Port	Connects Fiber to the Unit (Laser Aperture)
7	Key Switch	Turns Display of the Unit ON & OFF
8	Remote Interlock Port	Connects optional Remote Interlock to the Unit
9	Cooling Vents	Cooling Vents
10	Circuit Breaker	Master ON/OFF Switch
11	AC Power Connector	Connects Power Supply to the Unit
12	Quick Start Guide (QSG)	Quick Start Guide (QSG)
13	Operating Instructions Manual	Operating Instructions Manual
14	Transportation Box	Transportation Box (Picasso Only)
15	Unit Keys	Used to Turn Machine Off/On
16	Laser Eyewear Protective Goggles (3)	ANSI Z87, 800–820 nm, Optical Density (OD), includes Protective Case
17	Wireless Foot Control	Wireless Foot Control Standard Picasso Plus and Picasso Lite Plus
18	Power Cord	Power Cord
19	AC Adapter	Connects the Unit & Net Power Supply Input: 100–240 V 50/60 Hz, Output: 12V, 5A AC/DC adapter is specified as a part of ME EQUIPMENT.
20	Articulating Paper	Sample of Paper to Be Used for Laser Tip Initiation
21	Laser Danger Sign	Danger Sign for Operatory (Included at End of Manual)
22	Training Certification DVDs	ICLE Training/Certification DVDs
23	Set-Up DVD	Set-Up DVD
24	Remote Interlock	Optional Remote Interlock (can be obtained from AMD LASERS)

MAIN UNITS: PICASSO | PICASSO LITE – FIGURE 1



INDICATIONS FOR USE

Use of Picasso Plus and Picasso Lite Plus is generally indicated for incision, excision, vaporization, ablation and coagulation of oral soft tissues including the following:

- Gingival troughing for crown impression
- Gingivectomy
- Gingivoplasty
- Gingival incision and excision
- Hemostasis and coagulation
- Excisional and incisional biopsies
- Exposure of unerupted teeth
- Fibroma removal
- Frenectomy and frenotomy
- Implant recovery
- Incision and drainage of abscess
- Leukoplakia
- Operculectomy
- Oral papillectomies
- Pulpotomy
- Pulpotomy as an adjunct to root canal therapy
- Reduction of gingival hypertrophy
- Soft tissue crown lengthening
- Treatment of canker sores, herpetic and aphthous ulcers of the oral mucosa
- Vestibuloplasty

LASER PERIODONTAL PROCEDURES

- Sulcular debridement (curettage, removal of diseased, infected, inflamed and necrosed soft tissue in the periodontal pocket to improve clinical indices including: gingival index, gingival bleeding index, probe depth, attachment loss and tooth mobility)
- Removal of highly inflamed edematous tissue affected by bacteria penetration of the pocket lining and junctional epithelium
- Picasso laser assisted new attachment procedure (cementum-mediated periodontal ligament new-attachment to the root surface in the absence of long junctional epithelium)

TEETH WHITENING INDICATIONS (PICASSO PLUS ONLY)

- Laser assisted whitening of teeth
- Light activation for whitening materials for teeth whitening

SET-UP INFORMATION

PICASSO PLUS AND PICASSO LITE PLUS SET-UP

For details refer to Quick Start Guide. See FIGURE 1 for identification of components.

WARNING: Use of this equipment adjacent to or stacked with other equipment should be avoided because it could result in improper operation. If such use is necessary, this equipment and the other equipment should be observed to verify that they are operating normally.

- Place unit in a clean, dry, and well-ventilated area.
- Verify circuit breaker is in OFF position.
- Insert key into key switch. Verify it is in the OFF position.
- Verify Emergency Stop button is disengaged (UP position).
- Ensure that the battery is installed in the foot control switch.
- Connect power cord to power connector on unit and plug into wall outlet.
- Insert fiber into Fiber Connection Port by first removing small white protective cap from the connector end of the fiber. Save the protective cap for future use and take care not to touch the end of the fiber. Next, attach the fiber to the Fiber Connection Port (FIGURE 1, Item #6) by screwing the aluminum collar onto the Fiber Connection Port until the connection is “finger-tight.” If using strippable fiber, refer to the instructions provided with the fiber.
- Set up Delivery System Handpiece and Fiber (See FIGURE 5).

OPERATION INSTRUCTIONS

Turn ON Picasso Plus & Picasso Lite Plus

- Verify Red Emergency button (FIGURE 1, Item #4) is pushed in.
- Turn circuit breaker to ON position (FIGURE 1, Item #10).
- Rotate key clockwise to ON position.
- Select a PRESET or select a power level
- Press STANDBY/READY to place unit in READY Mode.
- Press foot control switch to fire laser and release to stop.

Turn OFF Picasso Plus & Picasso Lite Plus

- Press the STANDBY/READY button.
- Place handpiece back on handpiece holder.
- Switch circuit breaker to OFF position.
- Turn off and remove key from the unit, and place in a secure area.

CAUTION: VERIFY THAT THE FIBER OPTIC ASSEMBLY IS NOT TWISTED WHEN RETURNING THE HANDPIECE TO THE HOLDER. FIBER MAY BREAK IF IT IS TWISTED OR CRIMPED.

DO NOT LEAVE THE SYSTEM IN AN UNCONTROLLED ENVIRONMENT WHERE THE TEMPERATURE COULD DROP BELOW 41°F (5°C) (E.G. THE TRUNK OF A CAR). IF THIS OCCURS, ALLOW THE SYSTEM TO WARM UP TO ROOM TEMPERATURE FOR TEN TO FIFTEEN MINUTES BEFORE THE UNIT IS ACTIVATED.

CONTROL PANEL Picasso Plus | Picasso Lite Plus – FIGURE 2

Home Screen



Settings Screen





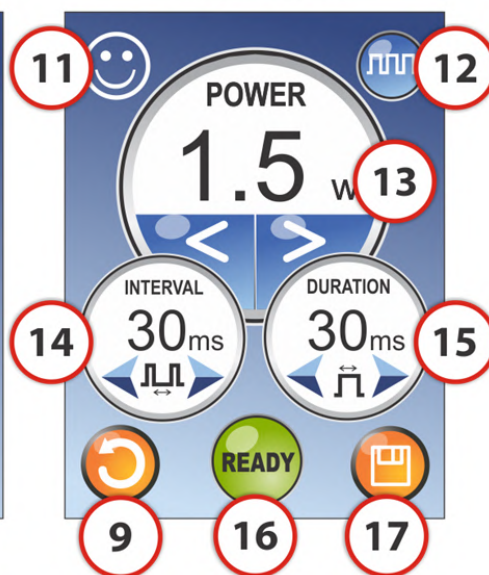





























Presets Screen



NOTE: PRESETS 5 and 6 ARE EXCLUSIVE TO PICASSO PLUS ONLY:



#	ITEM NAME	ITEM DESCRIPTION
1	 SPEED/ GENERAL SURGERY	CONT MODE; POWER: 1.8W
2	 COMFORT	POWER: 1.5W, INTERVAL: 30ms, DURATION: 30ms
3	 PERIO 1	POWER: 1.0W 30ms/30ms, TIMER: 5 sec. LBR - Laser Bacterial Reduction Mode. Tap  icon to switch to PERIO 2.
	 PERIO 2	POWER: 0.5W, TIMER: 30 sec. LAPT - Laser-Assisted Periodontal Therapy Mode. Tap  icon to switch to PERIO 1.
4	 APHTHOUS ULCER	POWER: 0.5W, TIMER: 30 sec. Laser will stop after 30 seconds and user must step on foot switch again to re-start the timer.
5	 WHITENING PICASSO PLUS ONLY	POWER: 7.0W, TIMER: 30 sec. Laser will stop after 30 seconds and user must step on foot switch again to re-start the timer.
6	 FAVORITE PICASSO PLUS ONLY	CONT MODE: POWER: 1.0W. Toggle the  icon to switch between continuous and repeat mode.
		REPEAT (PULSE) MODE: POWER: 1.0W, INTERVAL: 30ms, DURATION: 30ms
7	SETTINGS	 Language Selection, Aiming Beam, & Volume Settings
8	VOLUME SETTINGS	SPEAKER VOLUME:  LOW  MEDIUM  HIGH
9	RETURN	 Back Button
10	AIMING BEAM SETTINGS	AIMING BEAM INTENSITY:  OFF  MEDIUM  HIGH
11	PRESETS	<div style="display: flex; justify-content: space-around; align-items: center;"> <div style="border: 1px solid gray; padding: 5px; text-align: center;"> <p style="color: red; font-weight: bold; margin: 0;">Picasso+ and Picasso Lite+</p>      </div> <div style="border: 1px solid gray; padding: 5px; text-align: center;"> <p style="color: red; font-weight: bold; margin: 0;">Picasso+ only</p>   </div> </div>
12	MODES	 Continuous or  Repeating
	TIMERS	 5 seconds  or 30 seconds
13	POWER/ENERGY DISPLAY	0.5–7.0 W – TAP THE POWER DISPLAY TO SHOW ENERGY DELIVERED
14	INTERVAL	20 ms–9.9 sec, use the arrows to adjust
15	DURATION	20 ms–9.9 sec, use the arrows to adjust
16	STANDBY/READY	 Standby  or Ready Button
17	SAVE	 Save Button

Programming Presets

STEP 1: Select one of the six Presets (Picasso Plus) or one of the four presets (Picasso Lite Plus).

If the selected preset is a Continuous Mode, INTERVAL and DURATION are not available. POWER is able to be selected and saved as a preset.

If the selected preset is a Repeat Mode, all the parameters (INTERVAL, DURATION, and POWER) can be adjusted and saved as a preset. Use the arrow buttons to select desired interval and duration from 20 ms to 9.9 sec.

STEP 2: POWER. Select desired power settings 0.5–7 W (0.5-3W for Picasso Lite Plus) using the arrow buttons.

STEP 3: INTERVAL / DURATION. Select desired interval and duration, available only on REPEAT mode.

STEP 4: SAVE. Save desired settings by pushing the SAVE button until the beep is heard.

STEP 5: READY. Push STANDBY button to put unit into READY mode. Press the footswitch to fire the laser.

Repeat steps 1–4 to program additional presets.

Language Selection

English is the default language. Nine other languages are available: Italian / French / Spanish / Portuguese / Korean / Japanese / Russian / Chinese / German

To select another language, press the SETTINGS button. The system will then enter into the language selection display. Press desired language for two seconds, and the system will restart in the chosen language.

AIMING BEAM brightness settings

To select the brightness for aiming beam, first press the SETTINGS button. Then press the  button to change the brightness settings. There are three levels for Picasso: Off / Medium / High.

VOLUME settings

To select the volume, press the SETTINGS button. Then press the  button to change the volume settings. There are three levels: Low / Medium/High.

Custom/Favorite Preset (Picasso Plus Only)

The user is able to select POWER, INTERVAL, DURATION, CONT, or REP modes according to the operation. Pressing the SAVE button stores the selected parameters. The data is saved when the confirmation beep sound is heard.

WIRELESS FOOT CONTROL

Instruction for Use

STEP 1: Place wireless foot control on the floor.

STEP 2: To operate the wireless foot control, apply pressure to enclosed foot switch with your foot. The green LED Indicator light glows to indicate that the foot switch is operating when you step on the pedal to fire laser (Figure 3).



FIGURE 3

WARNINGS

DANGER: DO NOT USE IN THE PRESENCE OF FLAMMABLE ANESTHETIC MIXTURE WITH AIR, OXYGEN, OR NITROUS OXIDE.

DO NOT RE-USE DISPOSABLE OR SINGLE-USE ITEMS. FAILURE TO COMPLY MAY RESULT IN REINFECTION OR CROSS-INFECTION AND IS A HAZARD TO THE PATIENT.

DO NOT USE THIS UNIT IF YOU SUSPECT IT IS FUNCTIONING IMPROPERLY OR OTHER THAN DESCRIBED HEREIN.

Eyewear

Post appropriate warnings in operatories where the lasers are to be used, so that appropriate eyewear can be donned before the entry into the operatory. The doctor, patient, assistant, and any other persons in the operatory during laser procedures must wear the appropriate laser eyewear protection for the diode laser wavelength of 810 ± 10 nm with an optical density (OD) of at least +5. Class IV laser radiation is hazardous to the eye from the direct beam and diffuse reflections. It also represents a significant skin and fire hazard. Safety eyewear not designed to this specification is not suitable for use with Picasso lasers. Laser protective eyewear is available from your AMD LASERS representative.

Anesthesia

If anesthesia is required for treatment, closely monitor patients for signs of pain or discomfort. If such signs are present, adjust settings, apply anesthesia, or cease treatment, if necessary.

Adjacent Structures

Picasso Plus and Picasso Lite Plus are designed to remove soft tissue. Therefore, always be aware of adjacent structures and substructures during treatment and monitor them closely. Be extremely careful not to penetrate or ablate underlying or adjacent tissues. Do not direct laser energy toward hard tissues, such as tooth or bone. Directing laser toward amalgam, gold, metallic surfaces or reflective surfaces can result in laser beam reflection and/or scattered radiation.

Suction

Use high-speed suction as required to maintain a clear field of vision during treatment. Do not use Picasso Plus and Picasso Lite Plus if you cannot clearly see the treatment site. It is recommended that a

smoke evacuator or in-line filter be used to capture the plume during the treatment of herpetic lesions, oral papillomas, and whenever possible. It is recommended that personnel wear a half face respirator/clinical mask with proper HEPA™ filtration. The plume should be regarded as a source of active biological material as it may contain viable tissue particulates.

Training

Only licensed professionals who are certified in Class 4 laser use and have read and understood this Operating Instructions Manual shall use this device. AMD LASERS® assumes no responsibility for parameters, techniques, methods, treatments, or results. Clinicians and/or operators must use their own clinical judgment and professionalism in determining all aspects of treatment, technique, proper power settings, interval, duration, etc. A six hour laser certification course is available from AMD LASERS prior to use.

Heat Generation

The end of the fiber optic cable, disposable tips, and non-disposable tips, cannulas, and the handpieces may become hot during use. Avoid unnecessary contact with tissue.

Disposable Tips

The disposable tips are designed and labeled for SINGLE USE only. These tips are not meant to be bent more than one time, and bent no more than 90°. They are designed to be bent once to the preferred angle, used on a single patient, and then disposed of properly. Bending the disposable tip more than once in an unintended manner is a risk to the fiber optic cable inside the cannula leading to potentially lowered power output. When the handpiece is not in use, place protective cap over the tip to prevent dust or contamination.

Additionally, bending the metal cannula in the Disposable Tip in an unintended manner can lead to a breakage resulting in a potential sharp point which could puncture the skin of the patient or office personnel. Care should be taken to not bend the metal cannula multiple times.

CAUTION: ALWAYS CHECK FOR PRESENCE OF THE AIMING BEAM BY SHINING THE TIP ONTO A NON-REFLECTIVE SURFACE BEFORE FIRING THE LASER. IF THE AIMING BEAM SETTING ON THE DEVICE IS NOT "OFF" AND YOU DO NOT SEE THE AIMING BEAM, DO NOT USE THE TIP. IT MAY BE BROKEN WHICH COULD RESULT IN HEATING OF THE METAL CANNULA POTENTIALLY CAUSING AN ACCIDENTAL BURN TO THE PATIENT.

PRECAUTIONS

AMD Picasso Plus and Picasso Lite Plus Diode Laser Systems are for Dental Use Only according to the Indications for Use in this OIM Version of the manual. The laser is to be used under the supervision of a Dental professional.

Laser tips, once initiated, are extremely HOT. Touching flammable surfaces with an initiated tip is not recommended.

Periodic cleaning of the tip during procedures is required to keep the efficiency of the heat transfer. If removing coagulum, use CaviCide™ or other equivalent solution following manufacturer’s instructions. If using any product containing alcohol, make sure to allow tip to air dry fully prior to re-initiating the tip. When placing the handpiece on the laser holder, make sure to have the tip pointing away from all plastic articles to avoid damage to the plastic and/or the tip.

Units can only accept one input at a time. Laser settings will reflect the last input from the user.

CAUTION: DIODE LASERS ARE ATTRACTED TO MELANIN AND HEMOGLOBIN. POWER LEVELS ARE INVERSELY RELATED TO THE AMOUNT OF PIGMENTATION AND VASCULARITY OF THE TARGETED TISSUE. AS PIGMENTATION VARIES FROM PATIENT TO PATIENT, START WITH THE LOWEST POWER SETTING AND INCREASE AS NEEDED TO ACCOMPLISH THE PROCEDURE IN TISSUES WHICH HAVE LOWER MELANIN AND VASCULAR CONTENT; USE ANESTHETIC AS NEEDED FOR PATIENT COMFORT.

STEP-BY-STEP INSTRUCTIONS

MULTI-TIP HANDPIECE WITH FIBER

The delivery system used in conjunction with removable and disposable tips consists of the Multi-Tip Handpiece/fiber assembly:

Multi-Tip Handpiece & Fiber

- Picasso (orange) / Picasso Lite (black)
 - Length: 2 meters
 - F.C. Connector and Handpiece
- NOTE: Tips are not autoclavable.



Disposable Tips & Protective Cap

The advantage of a disposable tip over the traditional strippable and cleavable fiber is reduced set-up time since no stripping or cleaving of fiber is necessary. This accessory device is an “applied part” per IEC 60601-1.

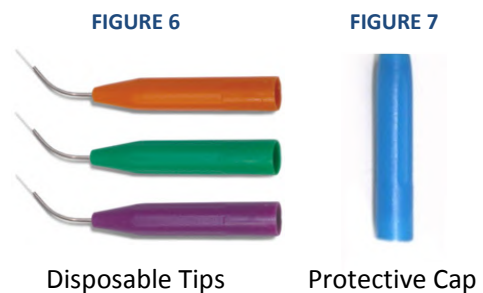

CAUTION: THE DISPOSABLE TIPS (FIGURE 6), WHICH ARE THE APPLIED PARTS ARE FOR SINGLE USE ONLY AND MUST BE CLEANED PRIOR TO USE.

Using Disposable Tips:

- Assorted bendable tips are available for use with both the Picasso Plus and Picasso Lite Plus Laser.

- Disposable tips are not sterile, and must be cleaned with a disinfectant wipe prior to use. If alcohol wipes are used, air dry prior to installing the tip on the Multi-Tip Handpiece and initiating the tip for use.
- Purple tips are 300 µm in size, available in 5 mm and 10 mm length.
- Orange tips are 400 µm in size, available in 5 mm and 10 mm length.
- Green tips are 200 µm in size, available in 20 mm length.
- **When using 200 µm and 300 µm tips, you must set the power on your laser in accordance with the instructions provided inside the tip box.**
- **300 µm and 400 µm tips may be used according to the Picasso or Picasso Lite duty cycle up to 5W. The 200 µm tips may not be used above 3W according to the established duty cycle. For any wattage, the surgical hand piece is also suitable. Only the Quadra tip can be used at wattages above 5W in the Picasso only for whitening purposes.**

WARNING: To avoid eye or skin exposure to direct or scattered radiation, do not use the Picasso Plus or Picasso Lite Plus without the appropriate tip for the procedure being performed.

CAUTION: USE A DISINFECTING WIPE, SUCH AS CAVIWIPES™ TO CLEAN THE DISPOSABLE TIP PRIOR TO USE.

To install a disposable tip, remove the blue protective cap (Figure 7) and slide the tip over the handpiece until the tip is fully seated.

You should hear and feel a slight 'click' when the tip snaps into place. To remove, pull gently on the tip and dispose of properly. The tip initiation procedure is the same as in the case of traditional fiber (refer to the Quick Start Guide).

These tips have a bendable steel cannula allowing the user to customize the angle of each tip for a specific application. The tip can be bent from 0° to a maximum of 90°. To bend the tip, pressure should be applied only in the middle of the metal cannula to form a smooth curve. See the Quick Start Guide for additional information.

CAUTION: DO NOT BEND THE TIP MORE THAN 90 DEGREES. DO NOT BEND THE TIP AT THE BASE OF THE CANNULA.

Bending the disposable tip more than once in an unintended manner is a risk to the fiber optic cable inside the cannula leading to potentially lowered power output.

After bending to the desired angle, the cannula should be visually inspected to ensure the tip is intact. Care should be taken to not bend the metal cannula multiple times.

CAUTION: ALWAYS CHECK FOR PRESENCE OF THE AIMING BEAM BY SHINING THE TIP ONTO A NON-REFLECTIVE SURFACE BEFORE FIRING THE LASER. IF THE AIMING BEAM SETTING ON THE DEVICE IS NOT "OFF" AND YOU DO NOT SEE THE AIMING BEAM, DO NOT USE THE TIP. IT MAY BE BROKEN WHICH COULD RESULT IN HEATING OF THE METAL CANNULA POTENTIALLY CAUSING AN ACCIDENTAL BURN TO THE PATIENT.

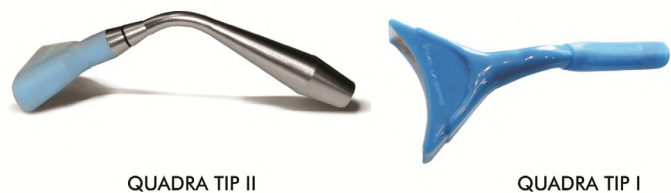

FIGURE 8

THE QUADRA TIP (PICASSO ONLY)

The Quadra Tip I or Quadra Tip II is used in conjunction with the Multi-Tip Handpiece for teeth whitening only. To use the Quadra Tip, remove the protective cap from the end of the Quadra Tip and slide it onto the Multi-Tip Handpiece (MTHP) until you hear a click.

NOTE: The AMD LASERS logo should face up on the adapter, and the notch on the adapter should align with the Quadra Tip peg.

The Quadra Tip is used 1–2 mm from the teeth once the bleach is placed on the teeth. Do not contact the patient with the Quadra Tip. Follow the instructions provided with the Whitening Gel.

CAUTION: THE QUADRA TIP IS NOT AUTOCLAVABLE AND SHOULD BE COLD DISINFECTED ONLY. IT IS NOT A DISPOSABLE, SINGLE-USE ITEM.

CLEANING INSTRUCTIONS FOR THE MULTI-TIP HANDPIECE AND QUADRA TIP

The use of CaviWipes™ Disinfectant and Cleaner is recommended for cleaning the Multi-tip Handpiece and Quadra Tip. Please follow the recommended instructions provided by the manufacturer for use and disposal.

STRIPPABLE FIBER WITH SURGICAL HANDPIECE



NOTE: The fiber optic cable, handpiece, and tips are shipped non-sterile.

The Delivery System consists of the following:

- Fiber Optic Assembly
- Handpiece
- Accessories: Adapter (to be used with disposable cannula)
- Picasso Plus and Picasso Lite Plus Handpiece Kit

NOTE: The standard fiber optic cable assembly is a 400 µm fiber.

NOTE: The fiber optic cable, handpiece, and tips are reusable accessories that require cleaning and sterilization before and after each use. For instructions on cleaning and sterilization of the fiber optic cable, handpiece, and tips, refer to section “MAINTENANCE”. Fiber optic cable is not autoclavable unless labeled as “autoclavable”.

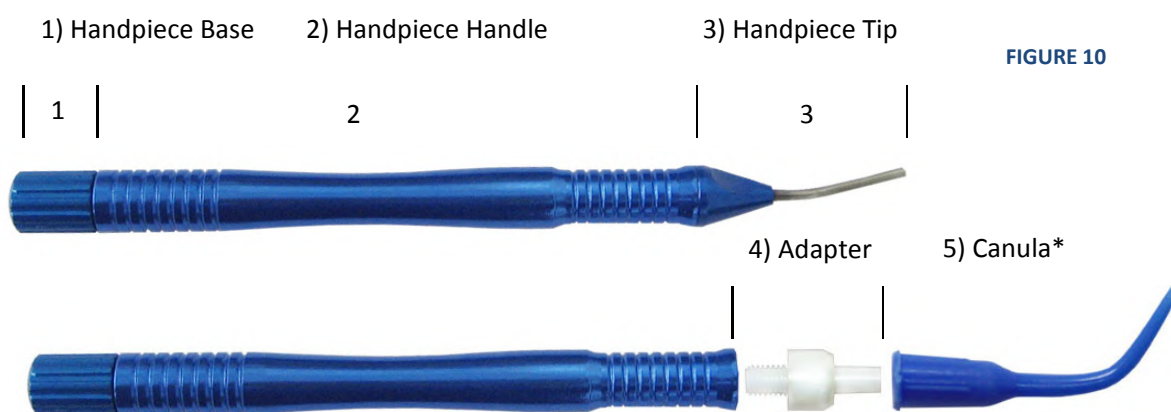

* Customer supplied disposable tip (18 gauge or larger)

To connect handpiece to fiber optic assembly:

1. Loosen handpiece base (FIGURE 11)
2. Slide fiber through handpiece base, handle, and tip
3. Approximately 3–4 in (~7–10 cm) of fiber should protrude
4. Strip and cleave fiber (FIGURES 12 and 13)
5. Adjust to desired length
6. Gently tighten handpiece base to secure the fiber

DIRECTIONS FOR STRIPPING AND CLEAVING PICASSO PLUS AND PICASSO LITE PLUS FIBER



FIGURE 11



FIGURE 12



FIGURE 13

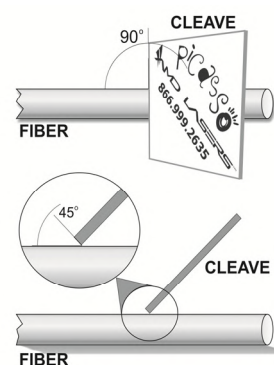

FIGURE 14

Strippable fiber should be stripped/cleaved after each procedure.

1. Loosen the proximal end of the handpiece by unscrewing the handpiece base (FIGURE 11).
2. Push fiber optic cable into the base of the handpiece until fiber appears from the tip. Pull fiber approximately 3–4 inches (~7–10 cm) out of the tip.
3. Slide the black stop marker on the stripper to approximately 1 inch (2.5 cm). Insert fiber into the stripper until the end of the fiber touches the marker. Squeeze the red stripper handles pulling the stripper away from the handpiece in a smooth motion to ensure that the fiber coating is cleanly removed. Grasp the fiber just above the handpiece with a firm grip (FIGURE 12).
4. Use the ceramic cleaver to lightly scratch the end of the fiber. Place the fiber against a flat surface. Position the edge of the cleaver approximately ¼ inch (0.6 cm) from the end of the fiber, and make a gentle scratch perpendicularly across the fiber (FIGURE 13), scribing (scratching) the surface at a 45° angle with the edge of the cleaver. Make sure that the edge of the cleaver is always perpendicular to the fiber during cleave/scribing (FIGURE 14).
5. Hold the end of the fiber above the cleaver between fingers and bend the end of the fiber until the end section breaks off. If the fiber end is removed properly, the fiber should be flat.
6. Verify the cleaver/cleave quality by aiming the fiber at a flat surface and observe the shape of the spot created by the visible aiming beam. If the visible spot is a full circle, then the power output is optimal. If the circle is distorted, repeat only the cleave/scribing procedure presented in steps 5 and 6 until you obtain a circular beam.
7. After the fiber is successfully cleaved, pull the fiber back through the handpiece, adjust the fiber end to desired length. Tighten the handpiece base. Ensure that the fiber is secure by pulling lightly on the fiber optic cable at the proximal end.
8. Wipe the completed handpiece and fiber with a clean wipe similar to CaviWipe™.

CONTAMINATION CONTROL PROCEDURES FOR THE STRIPPABLE FIBER AND SURGICAL HANDPIECE

The contamination control suggested for fiber optic cable, handpiece, and interchangeable tips is the system sterilization method. However, before sterilization, Picasso Plus and Picasso Lite Plus reusable accessories (handpiece, fiber optic cable, and interchangeable tips) should be carefully cleaned per the following procedure.

NOTE: Fiber optic cable is not autoclavable.

CLEANING INSTRUCTIONS FOR PICASSO PLUS AND PICASSO LITE PLUS SURGICAL HANDPIECE & THE STRIPPABLE FIBER OPTIC CABLE

The cleaning process is intended to remove blood, protein, and other potential contaminants from the surface and crevices of reusable accessories. This process will also reduce the quantity of particles, microorganisms, and pyrogens present. Cleaning should be performed prior to sterilization and must be conducted only by qualified office personnel trained to perform the procedure and handle the Picasso Plus and Picasso Lite Plus Fiber Optic Delivery System.

Wear protective gloves when handling the contaminated delivery system. To disconnect the delivery system, follow the instructions for delivery system assembly presented in the section “Picasso Plus and Picasso Lite Plus set-up” under “Set-up Information”.

DISINFECTION INSTRUCTIONS FOR THE STRIPPABLE FIBER OPTIC CABLE

- Transport the delivery system to a decontamination/sterilization work area.
- Take the fiber and strip 1 inch (2.5 mm) off of the distal end of the fiber using the fiber cleaver. Make sure the part that has debris is removed entirely. Dispose of the contaminated fiber tip accordingly.
- Prepare a sterilizing and disinfecting solution of a CaviCide™ equivalent and submerge approximately 12 inches (30 cm) of the fiber's distal end into the solution for 5 minutes. For high level of disinfecting, immerse the fiber end for 30 minutes at 68°F (20°C).
- After this process is completed, thoroughly rinse and dry the fiber.
- For disposal of CaviCide™ equivalent disinfecting solution, please follow the manufacturer's instructions. CaviCide™ is not a product or trademark of AMD LASERS.

STEAM STERILIZATION FOR PICASSO PLUS AND PICASSO LITE PLUS SURGICAL HANDPIECE

Before sterilization, the handpiece must be cleaned and disassembled. For cleaning, follow the procedures previously described. To disassemble the handpiece from the fiber optic cable, carefully loosen the handpiece base and slide handpiece off of the fiber optic cable.

The process of thermal sterilization with saturated steam under pressure is carried out in an autoclave. To perform this procedure, follow these step-by-step instructions:

- Disassemble the handpiece, remove the rubber insert and store in a secure location for reassembly (**do not autoclave the rubber insert**).
- Place the handpiece and interchangeable tips inside a single wrap self-seal autoclave pouch.
- Remove autoclave tray and place pouch(es) on the tray.
- Place tray inside the autoclave chamber and set controls to the following values: Temperature: 250°F (121°C), Pressure: 15 PSI (1 Bar), and Time Cycle: 30 minutes
- At the completion of the autoclave cycle, remove the tray and let the handpiece cool and dry. There is no specific requirement for the drying time.
- Attach the handpiece and the fiber optic cable to the unit for the next procedure.

CAUTION: DO NOT PLACE OR STACK OTHER DEVICES ON TOP OF THE FIBER OPTIC CABLE.

DISPOSAL OF USED FIBER TIPS, NON-WORKING FIBERS OR DISPOSABLE TIPS

Any portion of the fiber optic cable or disposable tip that comes in contact with a patient should be treated as a biohazard material and properly disposed of as governed by applicable laws and regulations.

CLINICAL APPLICATIONS

To efficiently remove tissue, it is imperative to understand the nature of the Picasso Plus and Picasso Lite Plus. Each laser operates unlike traditional devices. The techniques mentioned below must be practiced and perfected to ensure efficient operation. Please study this section carefully, practice on sample tissues, and attend a quality diode laser training seminar before using this device in a clinical

situation. The Picasso line of soft tissue lasers are designed for a number of surgical and non-surgical procedures. (See “Indications for Use”).

Only licensed professionals, who have successfully completed Picasso training and are certified in the use of Class IV lasers, have read and understand this manual, and know how to correctly operate the system, should use this device.

The use of the Picasso line of lasers can be used in a contact and non-contact modes. Surgery requires the initiation of distal 2–3 mm of fiber optic tip or fiber. Articulating paper is supplied with each laser for initiation. This initiation focuses laser energy to the tip.

Non-initiated tips are used in hygiene mode for the treatment of some ulcers and for other therapeutic reasons.

SOFT TISSUE SURGERY: CONTACT MODE

Cutting and coagulating soft tissue procedures can be utilized with either surgical handpiece or the multi-tip fiber handpiece and a disposable tip. The fiber tip or disposable tip must be initiated for cutting to occur. Operator should start with the lowest energy possible to achieve desired results. Disposable tips may not be used for procedures requiring more than 3.5 W.

Diode energy is highly absorbed by hemoglobin. The darker the pigment is the less energy is required to cut. Fibrous tissue requires more energy to cut. Most surgeries can be performed in the Speed or Comfort modes and a range between 0.5–3 W with either CONTINUOUS or PULSE MODES. Operator should try to use the least amount of power (WATTS) to achieve desired results.

When tissue builds up during a cutting procedure, remove the tissue using a clean gauze pad. Consult the accessories index for a complete listing of fibers and tips.

When procedure is complete, turn off the laser, appropriately dispose of the tip, clean handpiece with CaviCide™ or similar material, cover with protective cover, and place the handpiece in the holder.

Always clean and use a new tip prior to use.

DESCRIPTION OF LASER OPERATION MODES

Picasso Plus and Picasso Lite Plus have two modes of operation: CONTINUOUS and REPEAT (or PULSE) MODE. In CONTINUOUS mode, the laser will deliver output radiation at the power level specified by the user for as long as the foot switch is held down. In REPEAT / PULSE mode, the laser will deliver output radiation at the power level specified by the user and in a pulse format defined by the user for Picasso or 30 ms for Picasso Lite. In pulse mode, the wattage is reduced meaning that a setting on 1.0 W in pulse mode may produce average power of 0.5 W at the tip if the duty cycle is 30ms on and 30ms off (50% duty cycle).

PICASSO+ | PICASSO LITE+ MODES

The following figure (Figure 15) identifies the various Modes of Operation:

FIGURE 15



PRODUCT SPECIFICATION

GENERAL

- Dimensions L x W x H 9.5" x 6" x 6.2" (240 mm x 150 mm x 160 mm)
- Weight: 2.0 lbs (1 kg) ± 20%
- Working Environment: Temperature 60°F/15°C–90°F/32°C, Humidity 25%–85%
- Storage: Temperature 50°F/10°C–122°F/50°C, Humidity 25%–85%

ELECTRICAL

- Power Supply Input Voltage: 100-240V AC 50-60Hz
- Power Supply Output Voltage: +12V DC
- Power Supply Output Current: 5.0A
- Power Supply Max Power Output: 60 Watts MAX
- External Fuses: None
- Main Control: Circuit Breaker
- On/Off Controls: Keyswitch, Circuit Breaker, Emergency Stop
- Remote Interruption: Remote Interlock Connector (Optional)
- Beam Divergence of Collimated Beam (Picasso Plus and Picasso Lite Plus): 11 deg +/- 3 deg
- Cables:
 - AC Power cord 9.5 Feet (2.89 meters)
 - DC Input cord 6 Feet (1.82 meters)
 - Delivery Fiber Cable 9.8 Feet (3 meters)

LASER – PICASSO PLUS (Model P810)

- Laser Classification IV (4)
- Medium GaAlAs
- Wavelength 810 ± 10 nm
- Power Accuracy ± 20%
- Power Modes Continuous, Repeat Pulse
- Adjustable Pulse Duration 20 ms – 9.9 sec
- Pulse Interval 20 ms – 9.9 sec
- Delivery Fiber Diameter 200µm - 400µm
- Continuous Mode Preset to 1.8 W continuous, adjustable from 0.5–7.0 W
- Repeat Mode Adjustable 0.5–7.0 W, 20 ms – 9.9 sec interval and duration
- Comfort Mode Preset to 1.5W 30ms interval and duration
- Perio Preset 1 and 2 1. LBR – 1.0W 30ms interval and duration with a 5 second timer. 2. LAPT - 0.5W continuous with a 30 second timer.
- Aphthous Ulcer Mode 0.5W continuous with a 30 second timer

- Custom Mode Set to 1.0W by default
- Whitening Mode Preset to 7.0 W, 30 second timer
- Output Range 0.5–7.0 W \pm 20%

OTHER LIGHT SOURCES

- Aiming Beam 632 nm \pm 20%, max 5mW, Class 2 (IEC 60825-1) laser
- Medium Laser Diode

LASER – PICASSO LITE PLUS (Model PL810)

- Laser Classification IV (4)
- Medium GaAlAs
- Wavelength 810 \pm 10 nm
- Power Accuracy \pm 20%
- Power Modes Continuous, Repeat Pulse
- Pulse Duration Adjustable 20ms – 9.9s
- Pulse Interval Adjustable 20ms – 9.9s
- Delivery Fiber Diameter 200 μ m - 400 μ m
- Continuous Mode Preset to 1.8 W continuous, adjustable from 0.5–3.0 W
- Repeat Mode Adjustable 0.5–3.0 W, 20 ms – 9.9 sec interval and duration
- Comfort Mode Preset to 1.5W 30ms interval and duration
- Perio Preset 1 and 2
 1. LBR – 1.0W 30ms interval and duration with a 5 second timer.
 2. LAPT - 0.5W continuous with a 30 second timer.
- Aphthous Ulcer Mode 0.5W continuous with a 30 second timer
- Custom Mode Set to 1.0W by default
- Output Range 0.5–3W \pm 20% output

INSTRUCTION FOR ACCESSORIES

INITIATING TIP

Focusing laser energy to the end of the fiber or tip is necessary for cutting and coagulation to occur. The better the initiation the more focused and concentrated laser energy becomes. A sample of articulating paper is included with each Picasso laser.

Select the SPEED or HYGIENE MODE preset and drag the tip onto the articulating paper while firing the laser.

A good ignition will cover 3–4 mm of the tip with a dark carbonization (Figure 16).

Articulating paper is flammable and precautions should be followed to prevent unintended combustion. Once initiated, do not touch the tip anywhere other than where cutting tissue is a desired treatment.

For more information on initiation please consult the training DVDs included with your laser.

Initiating the tip of the Diode Laser is necessary for all procedures which require cutting or tissue removal.

Using provided or replacement articulating paper, rub the paper while firing the laser to cover 3–4 mm of the tip with carbonization.

Articulating paper is flammable. Please use and dispose of the articulating paper using fire proof collection bins in order to prevent accidental ignition of flammable materials. See Instructional video.



FIGURE 16

TEETH WHITENING (PICASSO PLUS ONLY)

Picasso teeth whitening should be performed only by trained personnel and as allowed by local, state and federal authorities. Picasso is designed for fast, efficient laser whitening with a unique laser adapter, the Quadra Tip. Most whitening is performed by first cleaning, pumicing the teeth, isolating the gingival and soft tissue mucosa with a liquid rubber dam, and applying the whitening manufacturer's bleach 1.5mm thick on the teeth. Picasso has a built in whitening mode.

The Quadra Tip (FIGURE 17) does not make contact with the patient during the whitening procedure. Refer to the specific instructions supplied with your whitening kit. Either the Quadra Tip I or Quadra Tip II may be included with your kit.

To select the WHITENING operation, the user simply selects the Whitening preset. In this mode, the mode is preset from the factory at 7.0 W with a 30 second timer. Releasing the foot control will interrupt the 30 second timer but will not reset it. Upon reaching 30 seconds, the timer will reset.

Pressing the foot switch will star the 30 second cycle again. The only variable parameter is the output power. To operate the laser in the WHITENING MODE press the STANDBY/READY button. The laser will now deliver output radiation as long as the

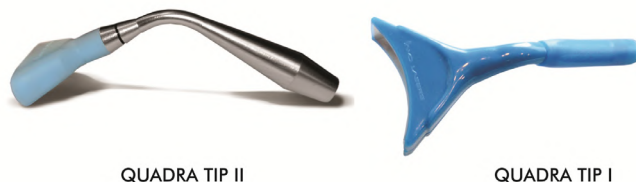

QUADRA TIP II

QUADRA TIP I

FIGURE 17

user holds the foot switch down. An audible signal will be sounded while the laser is active and the ready button will flash.

The WHITENING MODE output power can be changed to a lower setting at any time using the up/down arrow buttons. The system will momentarily blink off and then on again symbolizing the new parameter has been set. The Whitening procedure requires at least 5 W of power. Do not touch mucosa with the Quadra Tip during the whitening procedure.

MAINTENANCE

DENTAL LASER UNIT AND PLASTIC BARRIERS MAINTENANCE

This unit requires little operator maintenance. Wipe down the system with a cloth dampened with a mild antiseptic or cleaning solution—we recommend the use of CaviWipes™. Never use solvents or abrasive cleaners, which can damage the finish. Never pour or spray any liquid on or directly over the control console.

Protective plastic barriers can be used to protect the carrying handle, touch pad, handpieces, and goggles and are customer supplied.

ANNUAL MAINTENANCE

Picasso Plus and Picasso Lite Plus should be serviced annually by a qualified, AMD LASERS' trained technician. Please, contact your authorized representative or AMD LASERS® to discuss annual maintenance options.

To maintain compliance with the applicable IEC and CDRH regulations, all systems must be checked and verified that they are functioning properly in the event the unit has been subjected to adverse environmental conditions such as fire, flood, mechanical abrasion, solvent spillage, etc.

Calibration is required to maintain your laser in good operating condition. By regulation, power is allowed to vary a total of +/- 20% from the established rated power. (21 CFR 1040.10).

If calibration shows a variation of more than +/- 20%, the laser needs to be returned to the AMD Laser Repair Center for repair.

The following safety checks shall be carried out:

- Verify all labels are firmly in place.
- Verify disconnection of the remote interlock causes the laser to return to and remain in STANDBY.
- Verify the display indicates LASER FIRING when the foot switch is depressed.
- Verify the audible signal is active when the foot switch is depressed and laser emission is present.
- Verify the laser goes into and remains in STANDBY when the fiber is removed from the laser aperture.

TRANSPORTATION

Picasso Plus and Picasso Lite Plus lasers are susceptible to misalignment if not handled properly. The unit should ALWAYS be handled carefully and never banged, jarred, jolted, dropped, or hit. Do not transport the laser unless it is completely packaged inside of its transportation box. Failure to properly package the laser can result in damage to the laser and accessories. When transporting or shipping your laser you must always disconnect the keys, the AC Power Adapter, Remote Interlock, and fiber from the laser. Then, you must place the red protective cap on the Fiber Connector Port and replace the white and blue protective caps on the fiber. If you have any questions regarding transportation, please call your authorized representative or AMD LASERS®.

FOOTSWITCH BATTERY REPLACEMENT

Replacement of the battery in the footswitch can be performed by the user. To replace the footswitch battery, perform the following steps:

1. Remove the four (4) Philips head screws on the underside of the footswitch base covering the battery.
2. Remove the battery cover.
3. Disconnect the old 9V battery, connect the new 9V battery (noting polarity of the battery).

Caution: Use alkaline battery only.

4. Re-install the battery cover.
5. Insert and tighten the four (4) Philips head screws removed during Step 1.

ENVIRONMENTAL PROTECTION



Waste electrical products should not be disposed of with other common waste. Check with your Local Authority or Distributor for proper recycling advice on any component of the Picasso Laser System.

CALIBRATION PROCEDURE

The Picasso Plus and Picasso Lite Plus Dental Laser units are factory calibrated. For accurate treatment results, the unit(s) should be calibrated every 12 months following the date of purchase. It is required that the customer contact AMD LASERS since calibration procedure requires specialized equipment and technical expertise. Improper calibration could lead to instrument damage and failure to calibrate the laser.

DISCLAIMER: CALIBRATION BY ANYONE OTHER THAN A CERTIFIED AMD LASERS TECHNICIAN WILL VOID THE WARRANTY.

To schedule calibration of your unit, contact your authorized representative or AMD LASERS® at (866) 999-2635 to obtain an RMA or to be connected to the repair center closest to the laser location. Repair and maintenance centers are located worldwide.

CALIBRATION SCHEDULE

Purchase Date ____//____// _____	Authorized by: _____
Calibration 1 ____//____// _____ (12 months after purchase date)	_____
Calibration 2 ____//____// _____ (24 months after purchase date)	_____
Calibration 3 ____//____// _____ (36 months after purchase date)	_____
Calibration 4 ____//____// _____ (48 months after purchase date)	_____
Calibration 5 ____//____// _____ (60 months after purchase date)	_____

ERRORS AND WARNINGS

The Picasso Plus and Picasso Lite Plus lasers have an ability to provide operator with warnings and errors. Please see the error description with suggested steps to resolve it.

Remote Interlock Error



REMOTE INTERLOCK

This error appears on screen when the remote interlock connection has been opened. The laser shall immediately go into Standby mode and error shall disappear from the screen only upon closing remote interlock connection and placing the laser into Ready Mode by the operator.

Low Foot Switch Battery Error



**LOW FOOT
SWITCH BATTERY**

This warning appears when the wireless foot switch battery is low which is under 7V. You can clear the message from the screen by tapping the triangle area as long as the foot switch battery voltage is greater than 6.5V and continue using the laser. If the popup is cleared successfully, you can operate the laser without popup appearing again until laser is turned off and on again. Under 6V, the warning message changes to an error, laser goes and remains in Standby mode and all controls are disabled and persists on the screen until battery is replaced and the unit is turned off and on to clear the popup message and error.

Internal Fault – Service Required Error



This is a hard error, which means that you cannot erase it and continue using the unit. You can attempt to clear the error by turning unit off and back on but if the error persists, the laser unit must be sent in for service. The cause of the error can be: laser output outside tolerance limits, software fault, diode current or voltage limit outside limits. Upon this pop-up error, laser will go and remain in Standby mode and all controls are disabled.

High Laser Module Temperature Error



This pop-up Error shall occur if the diode laser module temperature exceeds 42°C. The pop-up shall remain on the screen until the temperature falls below 40°C. When this Error occurs, the system will go from the Firing or Ready state to the Standby state. No device settings or controls shall be available until the pop-up disappears.

Check Optical Fiber Connection Error



This error appears when the optical fiber connection in the front of the unit is not made (the micro-switch is not pressed-in). Laser shall go into Standby mode and remain in Standby mode until this error

is rectified. Please check optical fiber attachment and ensure that the optical fiber is tightened on the laser output aperture and closing the electrical connection on the micro-switch. The error message cannot be “erased” or ignored by the user.

Calibration Required Error



This pop-up will remain in place regardless of whether the error automatically corrects itself. You will be required to turn the unit off and then on again to attempt to clear the error. When the error occurs, the system will go from the Firing or Ready state to the Standby state. No device settings or controls shall be available. You should send the laser for calibration to AMD LASERS or nearest Authorized Service Center as soon as possible.

ELECTROMAGNETIC COMPATIBILITY (EMC)

The Picasso® Plus and Picasso Lite® Plus Soft Tissue Diode Lasers need special precautions regarding EMC and need to be installed and put into service according to the EMC information provided in this manual.

Portable and mobile RF communications equipment can affect the Picasso Plus or Picasso Lite Plus. The use of accessories and cables other than those specified by the manufacturer, AMD LASERS may result in increased emissions or decreased immunity of the Picasso Plus or Picasso Lite Plus. The Picasso Plus or Picasso Lite Plus should not be used adjacent to or stacked with other equipment and that if adjacent or stacked use is necessary, the Picasso Plus or Picasso Lite Plus should be observed to verify normal operation in the configuration in which it will be used.

Guidance and Manufacturer's Declaration - Electromagnetic Emissions		
The Picasso® Plus and Picasso Lite® Plus are intended for use in the electromagnetic environment specified below. The customer or the user of the Picasso Plus or Picasso Lite Plus laser should assure that it is used in such an environment.		
Emissions Test	Compliance	Electromagnetic Environment - Guidance
RF emissions CISPR 11	Group 1	The Picasso Plus and Picasso Lite Plus uses RF energy only for its internal function. Therefore, its RF emissions are very low and are not likely to cause any interference in nearby electronic equipment.
RF emissions CISPR 11	Class B	
Harmonic emissions IEC 61000-3-2	Not available	
Voltage Fluctuations / Flicker emissions	Not available	
The Picasso Plus and Picasso Lite Plus are suitable for use in all establishments other than domestic and those directly connected to the public low-voltage power supply network that supplies buildings used for domestic purposes.		

Guidance and Manufacturer's Declaration - Electromagnetic Emissions

The Picasso® Plus and Picasso Lite® Plus are intended for use in the electromagnetic environment specified below. The customer or the user of the Picasso Plus or Picasso Lite Plus laser should assure that it is used in such an environment.

Immunity Test	IEC 60601 Test Level	Compliance Level	Electromagnetic Environment - Guidance
Electrostatic discharge (ESD) IEC 61000-4-2	± 6 kV contact ± 8 kV air	± 6 kV contact ± 8 kV air	Floors should be wood, concrete or ceramic tile. If floors are covered with synthetic material, the relative humidity should be at least 30%.
Electrical fast transient/burst IEC 61000-4-4	± 2 kV for power supply lines ± 1 kV for input/output lines	± 2 kV for power supply lines Not Applicable	Mains power quality should be that of a typical commercial or hospital environment.
Surge IEC 61000-4-5	± 1 kV differential mode ± 2 kV common mode	± 1 kV differential mode ± 2 kV common mode	Mains power quality should be that of a typical commercial or hospital environment.
Voltage dips, short interruptions and voltage variations on power supply input lines IEC 61000-4-11	<5% U_T (>95% dip in U_T) for 0,5 cycle 40% U_T (60% dip in U_T) for 5 cycles 70% U_T (30% dip in U_T) for 25 cycles <5% U_T (>95% dip in U_T) for 5 sec	<5% U_T (>95% dip in U_T) for 0,5 cycle 40% U_T (60% dip in U_T) for 5 cycles 70% U_T (30% dip in U_T) for 25 cycles <5% U_T (>95% dip in U_T) for 5 sec	Mains power quality should be that of a typical commercial or hospital environment. If the user of the Picasso Plus or Picasso Lite Plus laser requires continued operation during power mains interruptions, it is recommended that the Picasso Plus or Picasso Lite Plus laser be powered from an uninterruptible power supply or the Boost® battery.
Power frequency (50/60 Hz) magnetic field IEC 61000-4-8	3 A/m	3 A/m	Power frequency magnetic fields should be at levels characteristic of a typical location in a typical commercial or hospital environment.

Note U_T is the a.c. mains voltage prior to application of the test level.

Guidance and Manufacturer's Declaration - Electromagnetic Emissions

The Picasso® Plus and Picasso Lite® Plus are intended for use in the electromagnetic environment specified below. The customer or the user of the Picasso Plus or Picasso Lite Plus laser should assure that it is used in such an environment.

Immunity Test	IEC 60601 Test Level	Compliance Level	Electromagnetic Environment - Guidance
Conducted RF IEC 61000-4-6	3 Vrms 150 kHz to 80 MHz	3 Vrms	Portable and mobile RF communications equipment should be used no closer to any part of the Picasso Plus or Picasso Lite Plus, including cables, than the recommended separation distance calculated from the equation applicable to the frequency of the transmitter. Recommended separation distance $d = [3.5/V1] \sqrt{P}$ $d = [3.5/E1] \sqrt{P}$ 80 MHz to 800 MHz $d = [7/E1] \sqrt{P}$ 800 MHz to 2.5 GHz where <i>P</i> is the maximum output power rating of the transmitter in watts (W) according to the transmitter manufacturer and <i>d</i> is the recommended separation distance in meters (m). Field strengths from fixed RF transmitters, as determined by an electromagnetic site survey ^a , should be less than the compliance level in each frequency range. ^b Interference may occur in the vicinity of equipment marked with the following symbol: 
Radiated RF IEC 61000-4-3	3 V/m 80 MHz to 2,5 GHz	3 V/m	

NOTE 1: At 80 MHz and 800 MHz, the higher frequency range applies.

NOTE 2: These guidelines may not apply in all situations. Electromagnetic propagation is affected by absorption and reflection from structures, objects and people.

^aField strengths from fixed transmitters, such as base stations for radio (Bluetooth® cellular/cordless) telephones and land mobile radios, amateur radio, AM and FM radio broadcast and TV broadcast cannot be predicted theoretically with accuracy. To assess the electromagnetic environment due to fixed RF transmitters, an electromagnetic site survey should be considered. If the measured field strength in the location in which the Picasso Plus or Picasso Lite Plus laser is used exceed the applicable RF compliance level above, the Picasso Plus or Picasso Lite Plus laser should be observed to verify normal operation. If abnormal performance is observed, additional measures may be necessary, such as reorienting or relocating the Picasso Plus or Picasso Lite Plus.

^bOver the frequency range 150 kHz to 80 MHz, field strengths should be less than 3 V/m.

**Recommended separation distances between
portable and mobile RF communications equipment and the Picasso® Plus or Picasso Lite® Plus**

The Picasso® Plus and Picasso Lite® Plus are intended for use in an electromagnetic environment in which radiated RF disturbances are controlled. The customer or the user of the Picasso Plus or Picasso Lite Plus laser can help prevent electromagnetic interference by maintaining a minimum distance between portable and mobile RF communications equipment (transmitters) and the Picasso Plus or Picasso Lite Plus laser as recommended below, according to the maximum output power of the communications equipment.

Rated maximum output power of transmitter W	Separation distance according to frequency of transmitter m		
	150 kHz to 80 MHz $d = [3.5/\sqrt{P}] \sqrt{P}$	80 MHz to 800 MHz $d = [3.5/\sqrt{P}] \sqrt{P}$	800 MHz to 2.5 GHz $d = [7/\sqrt{P}] \sqrt{P}$
0.01	0.12	0.12	0.23
0.1	0.37	0.37	0.74
1	1.17	1.17	2.33
10	3.69	3.69	7.39
100	11.67	11.67	23.33

For transmitters rated at a maximum output power not listed above, the recommended separation distance d in meters (m) can be estimated using the equation applicable to the frequency of the transmitter, where P is the maximum output power rating of the transmitter in watts (W) according to the transmitter manufacturer.











NOTE 1: At 80 MHz and 800 MHz, the separation distance for the higher frequency range applies.

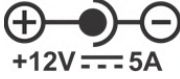

NOTE 2: These guidelines may not apply in all situations. Electromagnetic propagation is affected by absorption and reflection from structures, objects, and people.

ANNEX A: LABELS

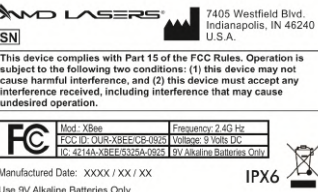

FIGURE 18



ITEM	SYMBOL	DESCRIPTION
1		Emergency Laser Stop
2		Picasso Plus Logo
3		Picasso Lite Plus Logo
4		AMD LASER Logo
5		Label for Optical Fiber (Picasso Plus & Picasso Lite Plus) and Warning for Laser Aperture Port
6		Remote Control
7		SPEC for DC Input
8		Laser Key Switch
9		QC Pass Inspection Label
10		Manufacturer Label (Picasso Plus)

11		Manufacturer Label (Picasso Lite Plus)
12		Warranty Void if Removed Label
13		IEC Explanatory Label (Picasso Plus and Picasso Lite Plus)

Footswitch labels

14		<p>FCC and IC Identification Label</p> <ul style="list-style-type: none"> • The S/N starting with DC is for Picasso Plus • The S/N starting with DL is for Picasso Lite Plus
15		<p>Battery Direction 9V Battery Label</p>

ANNEX B: ACCESSORIES

Item Description	Part Number
DISPOSABLE TIPS	
Disposable Bendable Tips - Assortment of 25	TIP25
Disposable Bendable Tip, 200µm, 60 Degree, 20mm	TIP2006020
Disposable Bendable Tip, 300µm, 60 degree, 5mm	TIP3006005
Disposable Bendable Tip, 300µm, 60 degree, 10mm	TIP3006010
Disposable Bendable Tip, 400µm, 60 degree, 5mm	TIP4006005
Disposable Bendable Tip, 400µm, 60 degree, 10mm	TIP4006010
FIBERS	
400µm Strippable Fiber - FC Connector	SF400-FC
400µm Strippable Fiber - ST Connector	SF400-ST
200µm Fiber With Multi Tip Handpiece, FC, Black Jacket for Picasso Lite Plus	MTHP-PL
300µm Fiber With Multi Tip Handpiece, FC, Orange Jacket for Picasso Plus	MTHP-P
Fiber Spool For Strippable Fiber	SFFS
Fiber Spool For Multi Tip Handpiece	MTHPFS
Surgical Handpiece 400µm Blue	SH
Surgical Handpiece (2) With Case	SH-KIT
Surgical Handpiece Case (Aluminum)	SHC
KITS	
Two Fiber Handpiece Pack	SF-PACK
Strippable Fiber Kit, 400um, FC	SF-KIT
Cleaving Stone "AMD"	CS
Red Fiber Stripper	FS
EYE PROTECTION	
Goggles - Adult Fit-Over Style	EYEF
Goggles - Adult	EYE
POWER	
Universal Power Cord (North America)	PCNA
European Style Power Cord	PCEU
12V Universal Medical Grade Power Adapter for Picasso+/Picasso Lite+	PS
WHITENING	
Laser Whitening Gel Kit (1)	WG-1
Laser Whitening Gel Kit (5)	WG-5
QUADRA Tip II for Multi Tip Hand Piece	QT
MISCELLANEOUS	
Articulating Paper	AP
Insert for blue surgical Handpiece (Bullet) - Black or White	SH-INSERT
Remote Interlock With 2 Keys	KEYS

PACKAGING	
Transport Case-Picasso, Black With 2 Keys	PCASE
MANUALS / TRAINING	
Picasso+ / Picasso Lite+ Owner's Information Manual	OIMDOM
Picasso+ / Picasso Lite+ Quick Start Guide	QSGDOM
Complete 4 Disc Set: ICLE Certification/ Setup	ICLE-4
ICLE Diode Certification Test Individual (1)	ICLETEST

AMD LASERS: TERMS AND CONDITIONS OF SALE

SHIPPING AND HANDLING

ALL DOMESTIC ORDERS WILL BE SHIPPED VIA STANDARD COURIER SERVICE, I.E. UPS. SHIPPING AND HANDLING WILL BE CALCULATED WHEN THE ORDER IS PROCESSED DEPENDING ON THE VALUE OF THE ORDER. STANDARD SHIPPING SERVICE IS UPS GROUND.

GOVERNING LAW, CONSENT TO JURISDICTION AND VENUE OF LITIGATION

THIS CONTRACT SHALL BE GOVERNED BY THE LAWS OF THE STATE OF INDIANA. ANY LITIGATION ARISING FROM A DISPUTE, ATTORNEYS' FEES, TRAVEL EXPENSES, COURT COSTS AND ANY OTHER RELATED EXPENSES ARE THE SOLE RESPONSIBILITY OF THE CUSTOMER. YOU HEREBY CONSENT TO PERSONAL JURISDICTION AND VENUE IN THE STATE OF INDIANA AND WAIVE ANY RIGHT TO TRANSFER VENUE. EACH PARTY WAIVES ANY RIGHT TO A TRIAL BY JURY.

ELECTRONIC SIGNATURES

YOU AGREE THAT AN ELECTRONIC COPY OF THIS CONTRACT OR SERVICE REPORT BEARING AUTHORIZED SIGNATURES MAY BE TREATED AS AN ORIGINAL.

RETURNS

ALL ORDERS MAY BE RETURNED WITHIN 30 DAYS OF SHIPMENT TO THE CUSTOMER. A 15% RESTOCKING FEE WILL BE CHARGED FOR ALL RETURNED ORDERS. ALL PRODUCT RETURNS MUST BE ACCOMPANIED BY A RETURN MATERIAL AUTHORIZATION (RMA) NUMBER ISSUED BY AMD LASERS WHICH CAN BE OBTAINED BY CALLING AMD LASERS AT (866) 999-2635. FOR LASER UNITS, THE TAMPER-EVIDENT TAPE MUST BE INTACT FOR THE UNIT TO BE CONSIDERED RETURNABLE. IN SOME CASES, AMD LASERS WILL REPLACE AN ACCESSORY OR PART UNDER THE LIMITED WARRANTY, BUT WILL REQUIRE THE RETURN OF THE DEFECTIVE PART. A CREDIT CARD WILL BE NEEDED TO SECURE THE VALUE OF THE DEFECTIVE UNIT AND WILL BE CHARGED IF DEFECTIVE PART IS NOT RETURNED TO AMD LASERS IN A TIMELY MANNER OR IF, UPON INSPECTION, AMD LASERS DETERMINES THAT THE RETURNED PRODUCT IS DEFECTIVE DUE TO MISUSE OR HANDLING AS OUTLINED IN THE LIMITED WARRANTY.

WARRANTY

AMD LASERS WARRANTS PICASSO OR PICASSO LITE FOR A PERIOD OF TWENTY-FOUR (24) MONTHS FROM THE SHIPMENT TO THE ORIGINAL PURCHASER/USER AGAINST DEFECTS IN MATERIAL AND WORKMANSHIP UNDER NORMAL USE AND SERVICE AND FIT FOR ORDINARY USE FOR WHICH DESIGNED, IF OPERATED BY A TRAINED AND COMPETENT OPERATOR AND IF PROPERLY SERVICED AND MAINTAINED. THIS LIMITED WARRANTY APPLIES ONLY SO LONG AS THE EQUIPMENT IS USED IN THE COUNTRY TO WHICH IT WAS ORIGINALLY SHIPPED BY AMD LASERS OR AUTHORIZED DISTRIBUTOR.

ALL RELATED ACCESSORIES USED IN CONJUNCTION WITH THE PRODUCTS INCLUDING BUT NOT LIMITED TO OPTICAL FIBER(S), HANDPIECE(S), QUADRA TIP, CLEAVER, AND STRIPPER, AND/OR PROTECTIVE EYEWEAR ARE WARRANTED FOR NINETY (90) DAYS AGAINST DEFECTS IN MATERIALS AND WORKMANSHIP. DISPOSABLE OR CONSUMABLE ITEMS (E.G. DISPOSABLE TIPS, WHITENING KITS, ETC.) ARE NOT COVERED BY THIS WARRANTY. THE LIMITED WARRANTY DOES NOT COVER ANY FEES OR COST ARISING FROM THE ANNUAL CALIBRATION OF THE UNIT.

THIS WARRANTY WILL BE VOIDED IF THE USER ATTEMPTS TO SERVICE THE EQUIPMENT (OTHER THAN PERFORMING THE MAINTENANCE DESCRIBED IN THE OPERATING INSTRUCTIONS MANUAL) OR IF SERVICE IS PERFORMED BY PERSONS WHO ARE NOT TRAINED OR AUTHORIZED TO DO SO BY AMD LASERS. IF THE UNIT IS FOUND TO BE DEFECTIVE WITHIN THE PERIOD SPECIFIED ABOVE AFTER EXAMINATION BY AN AUTHORIZED SERVICE REPRESENTATIVE OR AMD LASERS AND THE FAILURE WAS DUE TO DEFECTIVE MATERIALS AND/OR WORKMANSHIP, AMD LASERS WILL REPAIR, OR, AT ITS OPTION, REPLACE THE DEFECTIVE PARTS WITHOUT CHARGE. AMD LASERS RESERVES THE RIGHT TO MAKE SUCH AN EXAMINATION AND TO MAKE NECESSARY REPAIR/REPLACEMENT IN ITS OWN FACTORY, AT ANY AUTHORIZED REPAIR STATION, OR AT THE PURCHASER/USER'S PLACE OF INSTALLATION. IN THE EVENT THE USER DOES NOT COOPERATE WITH AMD LASERS IN PROVIDING SERVICE, YOU RELEASE AMD LASERS FROM ALL LIABILITIES WITH RESPECT TO WARRANTYING ANY EQUIPMENT OR ACCESSORIES. AMD LASERS WILL NOT BE RESPONSIBLE OR OBLIGATED TO THE PURCHASER/USER FOR LOSS OF REVENUES INCURRED BY THE PURCHASER/USER DUE TO THE PRODUCT REQUIRING SERVICE.

IN ORDER TO RECEIVE WARRANTY SERVICE, PICASSO PLUS AND PICASSO LITE PLUS LASERS MUST BE SHIPPED TO AMD LASERS IN ITS ORIGINAL TRANSPORTATION CASE AND PROPER SHIPPING BOX WITH FOAM PACKAGING. THE USER IS RESPONSIBLE FOR ALL SHIPPING COSTS. PLEASE REFER TO THE "RETURNS" SECTION OF THE TERMS AND CONDITIONS PRIOR TO SHIPPING ANY ITEMS TO AMD LASERS.

THE EXPRESS WARRANTY ABOVE IS THE SOLE WARRANTY OBLIGATION OF AMD LASERS AND REMEDY PROVIDED ABOVE IN LIEU OF ANY OTHER REMEDIES. THERE ARE NO OTHER AGREEMENTS, GUARANTEES OR WARRANTIES – ORAL OR WRITTEN, EXPRESSED OR IMPLIED – INCLUDING, WITHOUT LIMITATION, WARRANTY OF MERCHANTABILITY OR FITNESS FOR A PARTICULAR PURPOSE. AMD LASERS IS NOT RESPONSIBLE FOR CONSEQUENTIAL DAMAGES ARISING OUT OF ANY DEFECT, IMPROPER USE, OR UNAUTHORIZED SERVICE OR REPAIR. YOU ARE REQUIRED TO READ THE OPERATING INSTRUCTIONS MANUAL PRIOR TO USE OF THE PRODUCTS AND YOU ASSUME ALL RISKS AND LIABILITIES RESULTING FROM THE USE OF THE PRODUCTS.

OTHER

SALES TAX AND MEDICAL DEVICE EXCISE TAX MAY BE APPLICABLE DEPENDING ON APPLICABLE STATE AND LOCAL LAWS.

LIMITED LIABILITY

AMD LASERS® WILL NOT BE LIABLE FOR INCIDENTAL, CONSEQUENTIAL, INDIRECT, OR SPECIAL DAMAGES OF ANY KIND INCLUDING, BUT NOT LIMITED TO, DAMAGES FOR LOSS OF REVENUE, LOSS OF BUSINESS OR BUSINESS OPPORTUNITY, OR OTHER SIMILAR FINANCIAL LOSS ARISING OUT OF OR IN CONNECTION WITH THE PERFORMANCE, USE, OR INTERRUPTED USE OF THE "PICASSO" SYSTEM(S) OR ANY AMD LASERS® MATERIALS.

AMD LASERS®
7405 Westfield Blvd, Indianapolis, IN 46240

Tel: +1 (866) 999-2635
Fax: +1 (678) 868-4108

PAGE LEFT INTENTIONALLY BLANK

! DANGER

**Class 4 Laser
Controlled Area**

**Avoid eye or skin exposure to
direct or scattered radiation.**

Do not enter when door is closed.

**Laser eye protection required: OD \geq 4@810nm
AlGaAs Diode Laser, 810nm
3 Watts maximum power**

Laser Safety Officer



AMD LASERS®

ANSI Z136.1:2014

LBL-09001.PLP

PAGE LEFT INTENTIONALLY BLANK

DANGER

Class 4 Laser Controlled Area

**Avoid eye or skin exposure to
direct or scattered radiation.**

Do not enter when door is closed.

**Laser eye protection required: OD \geq 4@810nm
AlGaAs Diode Laser, 810nm
7 Watts maximum power**



PAGE LEFT INTENTIONALLY BLANK

Manufactured for
AMD LASERS
7405 Westfield Blvd.
Indianapolis, IN 46240 USA

T: +1 (866) 999-2635
F: +1 (678) 868-4108

U.S Patents 7,485,116 and 8,834,457.
Other U.S. and International patents pending.