

mifold[®] comfort

grab-and-go
backless booster seat

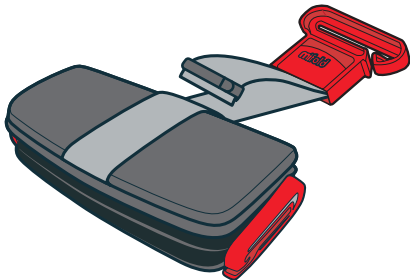

Age 4 years and upwards

This mifold booster seat is for use from 15 to 45kg (33 to 100 lbs).

The mifold is approved to UN ECE R44/04 as a Group 2-3 booster seat with a weight range of 15 to 36kg.

The mifold has been successfully tested for use by children weighing 45kg (100lbs.) or less.

USA: Approved to FMVSS 213

This child restraint conforms to all applicable Federal motor vehicle safety standards for use in motor vehicles.

Globally Regulated Version

ECE.R44/04
UNIVERSAL
15-36kg
Group 2 - 3



048643

Congratulations on receiving your mifold grab-and-go booster seat. mifold is the world's most compact and portable car booster seat. It is 10x smaller than a regular backless booster seat, and just as safe*.

This mifold is regulated for use worldwide (excluding Australia) so it can keep your child safe on every adventure. We hope you are happy with your mifold. Please share your positive experience with others and contact us with your feedback, pictures and videos.

Model Number: MF12-EU

We can be contacted on:

✉ support@mifold.com

🌐 www.mifold.com/contact

f facebook.com/mifold

📷 instagram.com/mifold

*Safety claim based on compliance with NHTSA FMVSS 213 and UNECE Regulation 44/04.

User Manual Storage

It is most important that these instructions remain with the mifold grab-and-go booster seat at all times. Store these instructions in the slot located on the edge of the mifold grab-and-go booster seat.

Read and follow all instructions and information in this manual, on the product labels, and in the vehicle owner's manual for booster seat and vehicle seat belt use.

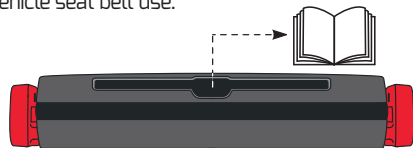

Introduction to your mifold grab-and-go Booster Seat

Before using this booster seat it is important to understand how to properly install your booster seat, secure your child correctly, and familiarise yourself with the features and functions of the booster seat.

It is important to take the time to read and understand these instructions fully. This is best done with the mifold grab-and-go booster seat in front of you.

Read all the safety warnings before using the booster seat.

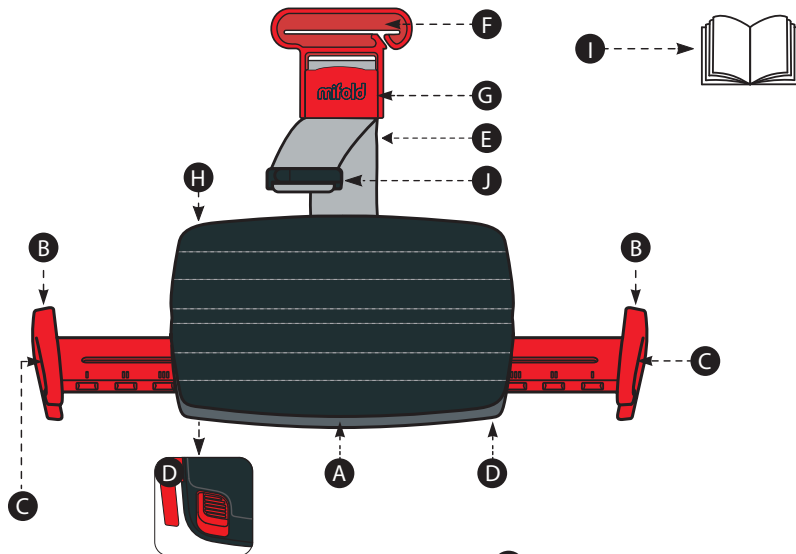

- A** Booster Seat
- B** Lap Belt Guide
- C** Lap Belt Slot
- D** Lap Belt Guide Release Button
- E** Shoulder Belt Guide Strap
- F** Shoulder Belt Guide
- G** Shoulder Belt Guide Buckle
- H** Booster Seat Cushion
- I** User Manual
- J** Storage Clip

Weight and Height Use Recommendations

- Child's weight **MUST** be between 15 and 45 kg (33 and 100 lbs.).
- Child's height **MUST** be between 90 and 150 cm (36 and 59 in.).
- Use only with a child that has outgrown their car seat with a 5-point harness and can sit in the booster seat properly for the entire duration of each trip. If your child will not remain seated properly, your child should use a child restraint with 5-point harness.
- **"Outgrown"** means the child's weight or height exceeds the use limits for the car seat.
- **"Sitting properly"** means the child must remain seated without slouching under lap belt, moving shoulder belt under arm or behind back, or leaning forward or sideways moving out of position so the vehicle belt remains properly positioned.
 - A booster seat is designed to position the adult vehicle belt correctly on the child.

Weight and Height Use Recommendations

- Vehicle lap belt **MUST** be positioned on the pelvis such that it is low on hips, contacting thighs and not up on the abdomen.
- Full width of vehicle shoulder belt **MUST** be on child's shoulder (not in contact with the neck and not off the shoulder).
- Child restraint laws vary from country to country and state to state. Check your local laws as they may have specific use requirements.
- **DO NOT** use when:
 - Child does not remain seated properly or does not keep the vehicle belt properly positioned.
 - Child's weight exceeds 45 kg (100 lbs.).
 - Child's height exceeds 150 cm (59 in.).
 - The vehicle belt fits on your child correctly without a booster seat.



Safety Instructions



- Always give preference to using the rear seats of your vehicle even if your highway code permits the use on the front seat.
- Check your highway code as this regulation may vary according to the country.
- Check the vehicle manual for advice on fitting your car seat in the front of the vehicle.
- Airbags can cause injury. Do not use this seat on passenger seats fitted with a frontal airbag.
- Your mifold grab-and-go booster seat must be positioned and installed so that, under normal vehicle usage conditions, no part can become jammed under or between any moveable seat, or in the vehicle door.
- Make sure there is no loose luggage or other large objects that are likely to cause injuries in the event of an accident. These items may cause injury to other occupants. Always secure loose items.
- Shade your booster seat from sunlight to avoid hot items causing injury to your child.
- Do not modify or add to your car seat in any way without the approval of a competent authority or the manufacturer, as this will void any warranty.
- Toxic cleaning fluids can cause illness. Never use bleach, do not iron, do not machine wash and do not tumble dry as this could damage the product.



Safety Instructions



- Do not leave your child unattended while in the booster seat and in the vehicle.
- The mifold booster seat is a unique design that absorbs some of the forces in a vehicle crash when occupied by a child. These crash forces can deform parts of the booster seat and result in damage that may not be detectable by a visual inspection. As a result, the booster seat **MUST** be replaced after any crash in which the booster seat was occupied.
- For a crash in which the booster seat was stored and remained in place or was secured with the lap portion of the vehicle seat belt passing through both lap belt guides, and was unoccupied at the time of the crash, the mifold may continue to be used.
- Store your booster seat in a safe area when your child is not in the car seat. An unsecured booster seat can cause injuries in the event of a collision.
- If you are in any doubt about any part of the installation or proper use of your booster seat, contact the booster seat manufacturer.
- Failure to follow these instructions may affect your child's safety.
- Keep these instructions with the booster seat to refer to for future reference.

Install Your Booster Seat

The seat can be used for a child aged 4 years and above, weighing 15kg – 45kg, securing the child with an adult 3 point safety belt with retractors approved to ECE R16 or equivalent standard.

Note: Your booster seat is designed to fit only with a 3 point lap and diagonal seat belt and must not at any time be fitted using only a 2 point lap belt.

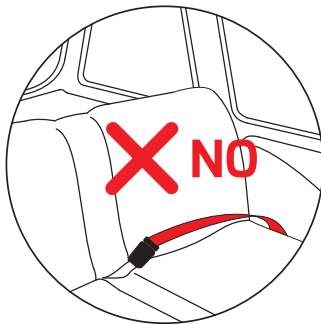

Prepare Your Booster Seat

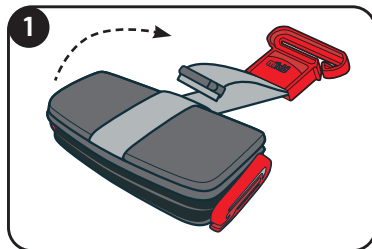

Open the booster seat and fold out the upper body.

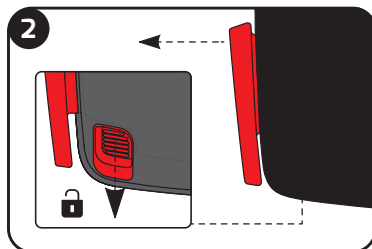

To unlock the lap belt guides, slide the Lap Belt Guide Release button forward.
To lock the guides, release the Lap Belt Guide Release button.

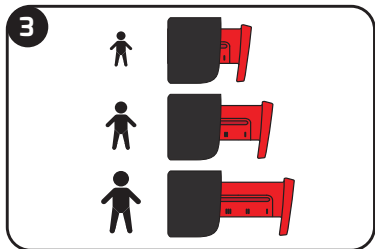

Extract the lap belt guides and position according to the chart.



To access the shoulder belt guide strap, pull open the shoulder belt guide buckle.



To shorten or lengthen the shoulder belt guide pull the strap in the desired direction.

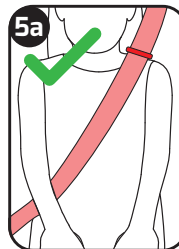
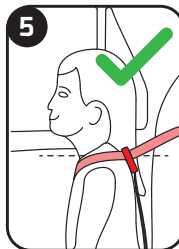

Ensure that the shoulder belt guide is positioned above and centred on your child's shoulder.

Install Your Booster Seat



Ensure that the booster seat is laid flat and up against the back rest of the vehicle seat.

For contoured vehicle seats, position back of booster seat on contour and in contact with vehicle seat back.

Seat child on the booster seat with child's bottom and back in contact with the vehicle seat back cushion.

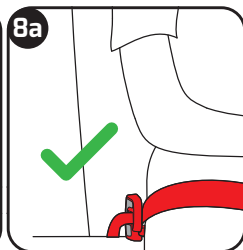
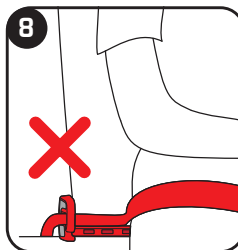
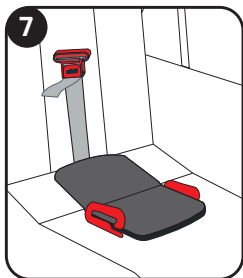

Position your child sitting upright on the booster seat and if necessary, slide lap belt guides into the position nearest to, but not touching the child's thigh. Pull out the lap belt guides to check they are locked into position.

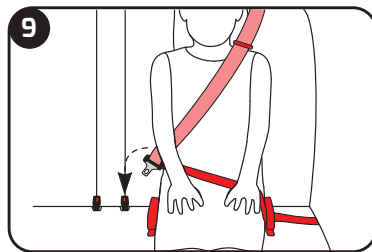

Extract the vehicle seat belt and pass it across the front of your child. Slide lap belt portion of vehicle seat belt through both lap belt guides and connect the seat belt tongue into the vehicle buckle.

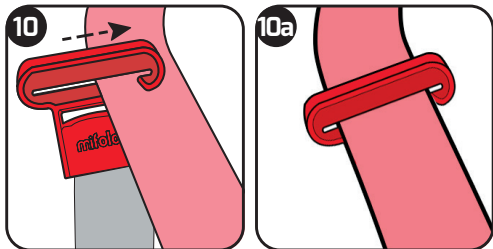

To position the shoulder belt guide, slide the shoulder belt guide onto the diagonal portion of the vehicle seat belt, as shown in figure 10.

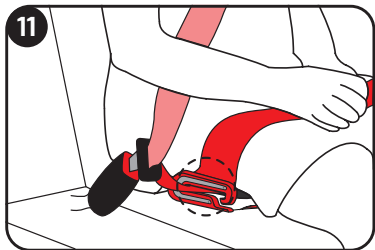

Insert the lap portion only of the vehicle seat belt through the red belt guides on each side of the booster.

WARNING! If the vehicle seat belt tongue is up against the red lap belt guide such that you cannot tighten the seat belt, this condition is unacceptable. You must use a different seat position.

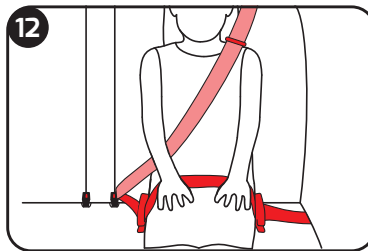

Ensure that the lap portion of the vehicle seat belt has passed through the lap belt slots on both sides of the booster seat.



Remove any twists or seat belt slack by pulling on the lap portion and then the diagonal portion of the adult seat belt.



Ensure that the lap portion is positioned over the child's lap and supported on the child's pelvis.

Pull up on vehicle shoulder belt to remove slack from lap portion of vehicle seat belt and snugly adjust lap belt around child.

Check that vehicle lap belt is low on hips and contacting thighs.



Final Checklist

However safe a child seat is, however well built it is, your child's safety depends on you carrying out the following checks before every journey:

- Check that the booster seat is facing forwards in the vehicle and in the direction of travel.
- Check that the vehicle seat belt is fitted correctly with the shoulder belt engaged with the shoulder belt guide, the lap strap is attached to the red lap belt guides, and the tongue is connected to the buckle.
- Check that the vehicle seat belt is not twisted or slack

IMPORTANT! Misusing your child seat will reduce the protection and safety you offer your child.

Maintenance Advice

The booster seat cover is not removable. In case of light staining, clean using a damp cloth or soapy water.



Safety Warning



Toxic cleaning fluids can cause illness. Never use bleach, do not iron, do not machine wash, do not tumble dry as this could damage the cover and require replacing.

Additional Information

This booster seat is not approved for use on aircraft. For more information, contact the airline.

To dispose of your booster seat safely always render the seat unusable.

IMPORTANT! Make sure the instruction book is removed from the slot before cleaning.

Notice

This booster seat is a “Universal” child restraint system. It has been approved in accordance with regulation ECE R44/04, and is suitable for general use in vehicles, and is compatible with the majority of vehicle seats.

- This child restraint is likely to fit if the vehicle manufacturer states that the vehicle approval specifies suitability for “Universal” child restraint systems.
- This restraint system is classified as “Universal” in accordance with the strictest approval criteria, whereas earlier models do not correspond to these new provisions.
- This restraint system can only be installed in vehicles with 3-point static or retractable seat belts that have been approved compliant with the UN/ECE No.16 or other equivalent standards.

If in doubt, contact the manufacturer of the restraint system.

© 2021 Carfoldio Ltd. Carfoldio™, mifold® and mifold the grab-and-go booster®, are registered trademarks of Carfoldio Ltd.

This innovative product is protected by patents and design registrations worldwide, including U.S. Pat. No. 9,376,088 and European Pat.

No. 13 797 456.4-1503 and other patents pending.

All pictures are illustrations.

Actual product may vary.

Contact Information



support@mifold.com



www.mifold.com/contact



facebook.com/mifold



instagram.com/mifold

Manufactured By:

carFoldio Ltd.

Unit 2407, PO Box 6945

London, W1A 6US, England, U.K.

Tel: 0800 4714984 (from within the U.K.)

Tel: +44 207 866 2385 (International)