

## IColor™ 800W Digital Color + White Transfer Media Printer User Manual



# Table of Contents

IColor™ 800W Model Summary	Page 3
Unpacking and Installing Consumables	Page 3 – 6
Warnings	Page 6
Loading Media	Page 7
Loading Banner Media (Optional Feature)	Page 8 – 9
Removing Jammed Media	Page 10
IColor™ ProRIP Software Introduction	Page 11 – 12
IColor™ ProRIP Software Installation	Page 13 - 16
IColor™ ProRIP Software First Time Setup	Page 16 - 21
Using the IColor™ ProRIP Software	Page 22 – 26
Achieving the darkest black color	Page 27
IColor™ SmartCUT Information	Page 28
UniNet IColor™ Consumable Replacement	Page 29
Cleaning the Dustproof Glass	Page 30 – 31
Color Registration Procedure	Page 31
IColor™ 800W Printing Tips	Page 32
Available Media Options	Page 33
Transfer Paper Comparison Charts	Page 33
IColor™ 800W System Specifications	Page 34

 **Important note about USB Drives shipped with your system:** Do not lose your RIP dongle! This is your license key and if lost or damaged, a cost for replacement will be incurred. UNINET suggests that you limit the physical handling of RIP dongles and use powered external USB hubs (as an example).

October 2022 Edition – A newer version of this manual may be available at [www.icolorprint.com/support](http://www.icolorprint.com/support)

# IColor™ 800W Model Summary

The IColor™ 800W printer has been developed to produce high-quality, conventional color prints with the out-of-the-box functionality of printing in white. Now you can print on media up to 12.6" x 49.6" with IColor™ Technology.

Please follow the enclosed quick setup guide, as well as this manual, to get started. The IColor™ 800W comes complete with 4 toner cartridges for full color + white printing (CMYW), including our exclusive fluorescent white cartridge. Print a white overprint (in one pass) in concert with the IColor™ ProRIP software. Black is produced using composite black (made from CMY), and features the blackest composite black in the industry.

Please note that vector and line art images, including text, are likely to produce the best results. For exciting design ideas and suggestions for using the IColor™ 800W for maximum effect, please visit our website at [www.icolorprint.com](http://www.icolorprint.com).

IColor™ Standard 550/800 2 Step media has been optimized to provide quality results when used with the printer, enabling the user to produce eye-catching designs which may be applied to a variety of textiles and surfaces.

## Unpacking and installing consumables

### Optimal Humidity Level:

**45% - 65%**

### Optimal Temperature Range:

**50°F / 10°C - 75°F / 24°C**

**Operation outside of these recommend parameters may lead to poor results.**

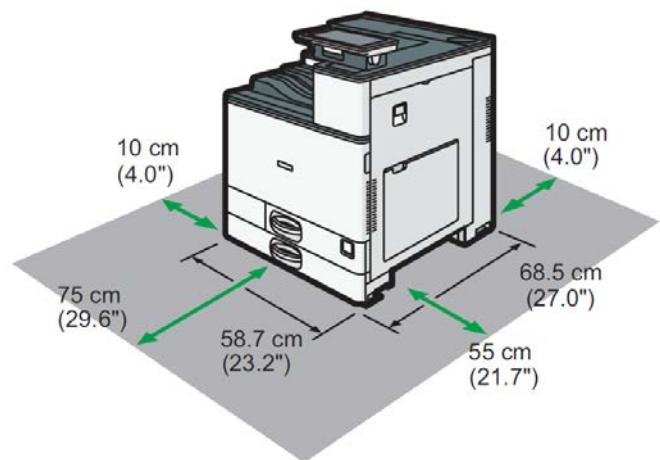

- ⚠ Take note of the install location, temperature and humidity settings which are suggested for optimal printing conditions.**
- ⚠ The use of a dedicated circuit of at least 15 amps is required to avoid potential fusing issues.**
- ⚠ Power consumption (max): 12 amps (120v models) or 8 amps (230v models)**

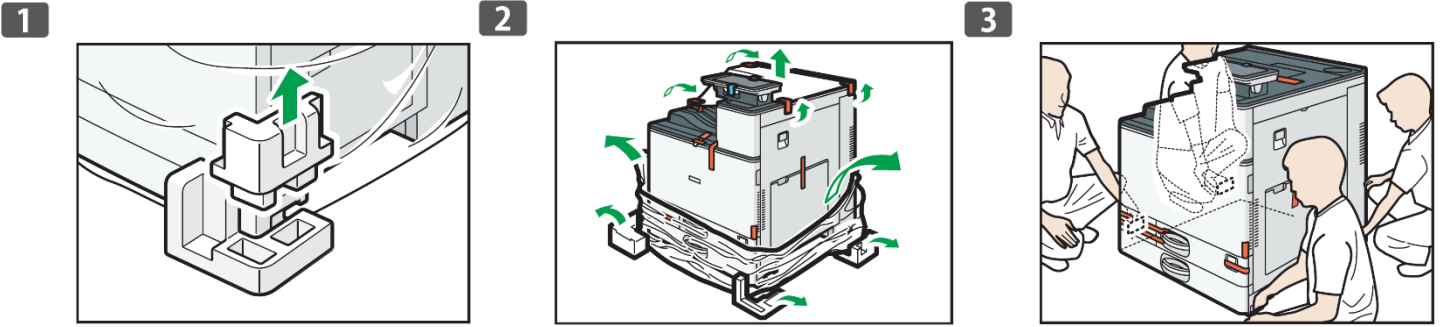

Lift locks up from the bottom of the box, unwrap the printer and team lift to remove from the packaging.

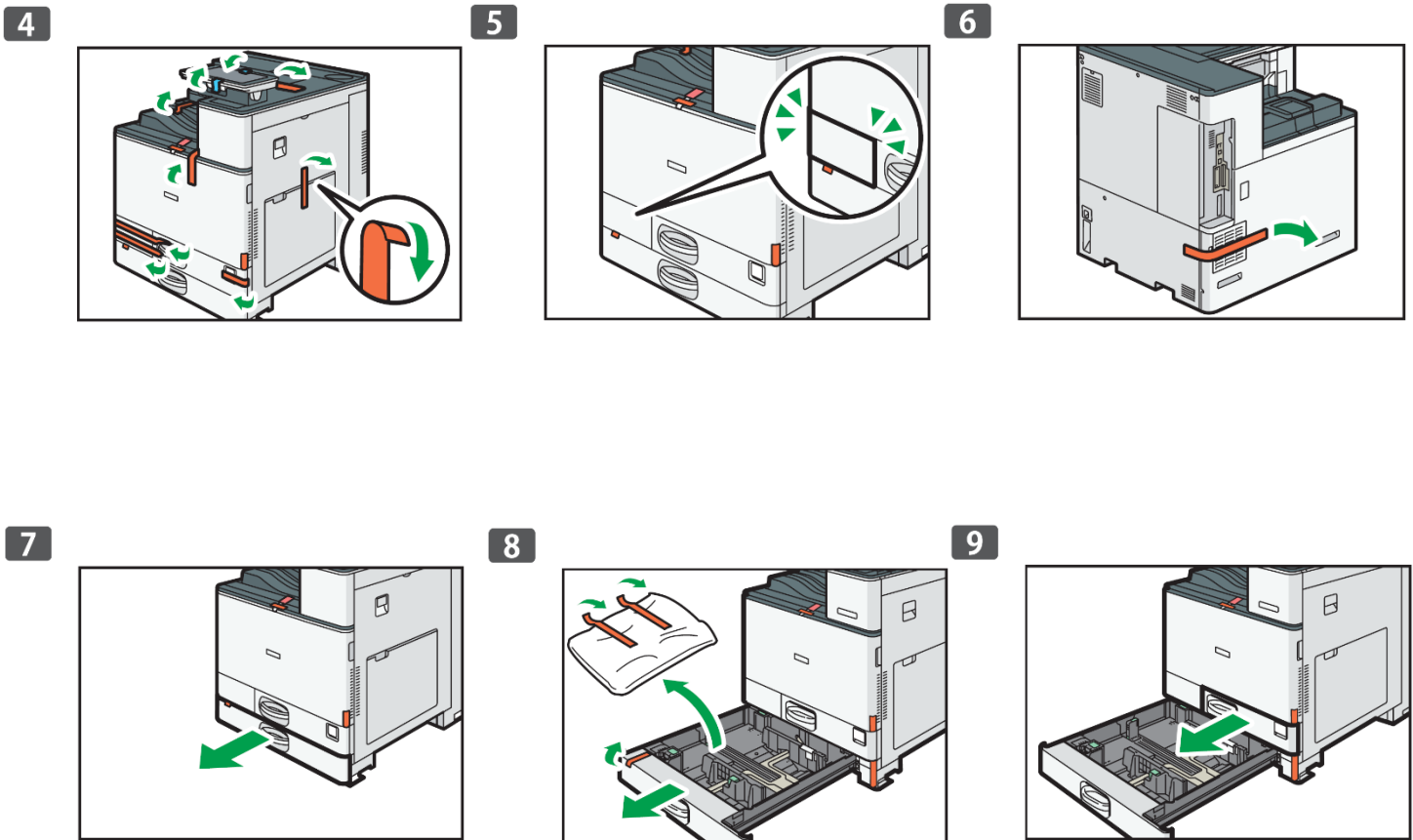

Remove orange tape and packing material as indicated.

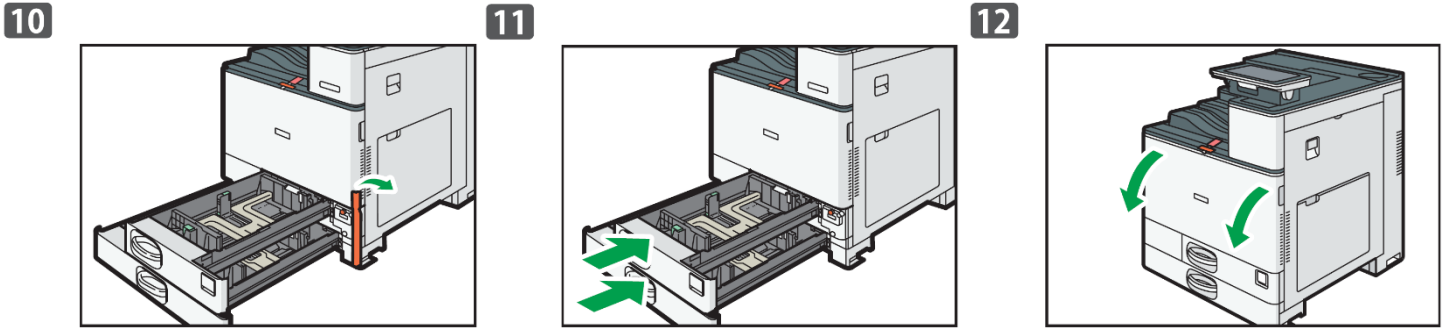

Close paper tray and open the main toner compartment.

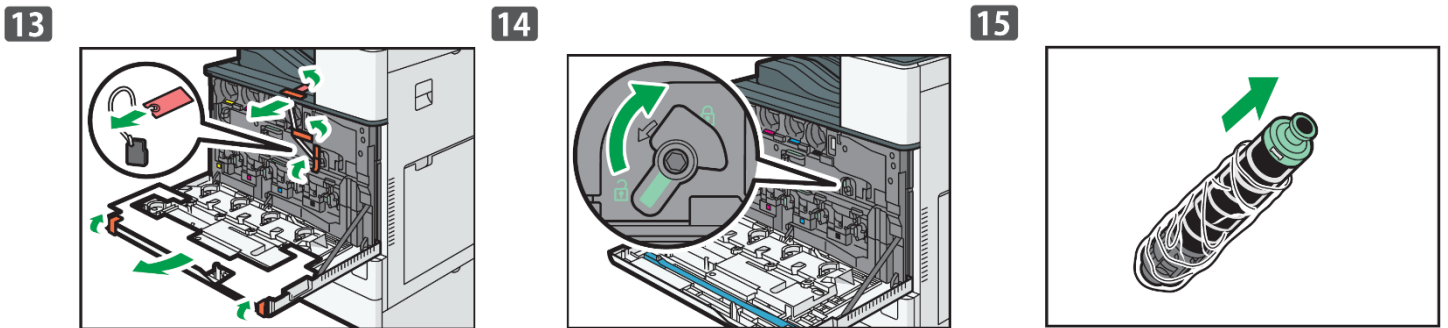

Remove the rest of the orange tape, set the lock and unpack the toner cartridges.

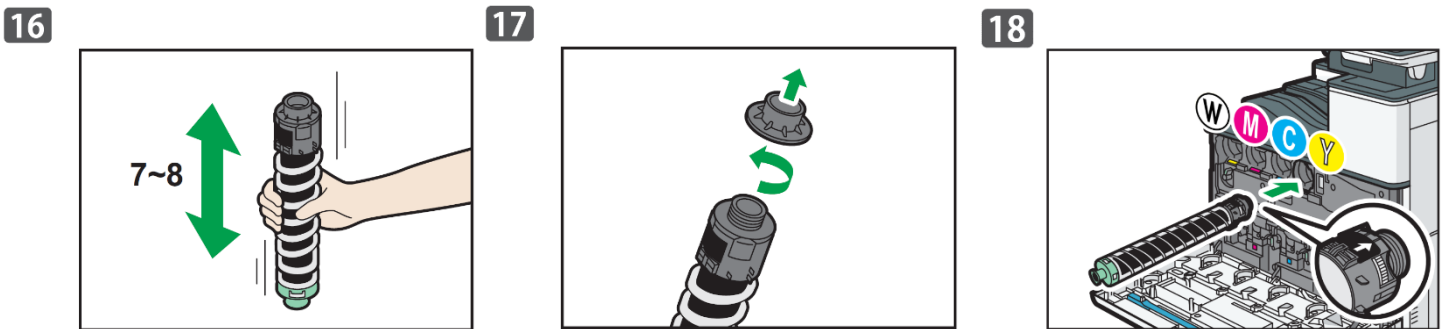

Gently shake each toner cartridge back and forth 7 or 8 times to loosen the toner that may be settled in the cartridge due to shipping. Unscrew the toner lock and insert each cartridge into the corresponding section with the arrow on top.

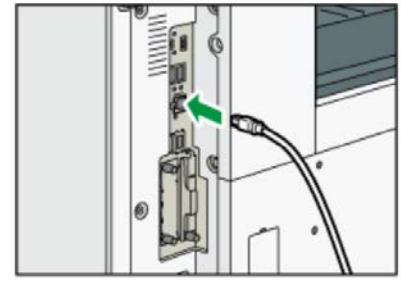
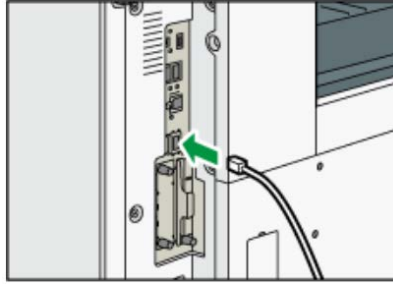
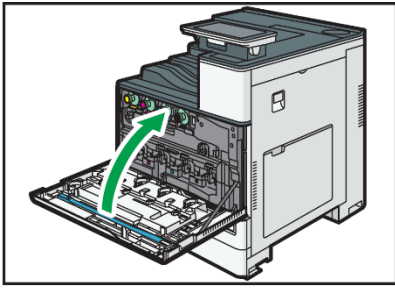

Close the main toner compartment. Connect either the network or USB cable depending on how you wish to operate the printer.

**⚠** Never insert both at the same time, use either network or USB only.

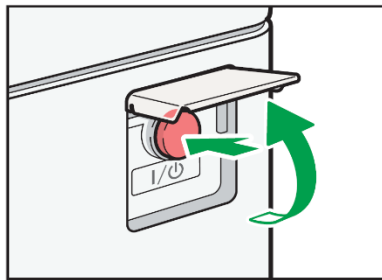
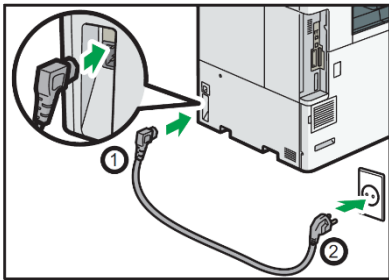

Plug in the power cord and power on the printer. The use of a dedicated circuit of at least 15 amps is required to avoid potential fusing issues.

## WARNINGS

- ⚠** Your IColor™ 800W printer has been preconfigured from the factory for optimal performance. UNINET strongly advises that you do **not** change any settings on the printer itself (through the control panel), unless specifically directed by a certified UNINET technician. Otherwise, poor or inconsistent results could arise.
- ⚠** Avoid setting custom administrator passwords or changing security settings on the printer control panel, as hardware changes cannot be overridden or changed by UNINET if the password is forgotten and could lead to possible irrevocable, catastrophic modifications that may result in rendering your printer inoperable. This is not covered by your warranty.
- ⚠** All print commands are dictated and transmitted solely by the IColor™ ProRIP software. Any required updates or modification would occur in the software and not hardware. It is always best not make any changes to preset data (hardware or software) unless specifically directed by a certified UNINET technician.
- ⚠** To ensure trouble free operation of the IColor™ ProRIP software, please uninstall any third party virus scan software before proceeding. Virus scan software often views RIP software as an invasive program and invariably deletes important files which can cause issues in the quality of the print or the overall operation of the software. Windows Defender is the only known virus scan software which does not conflict with the RIP.

# Loading Media

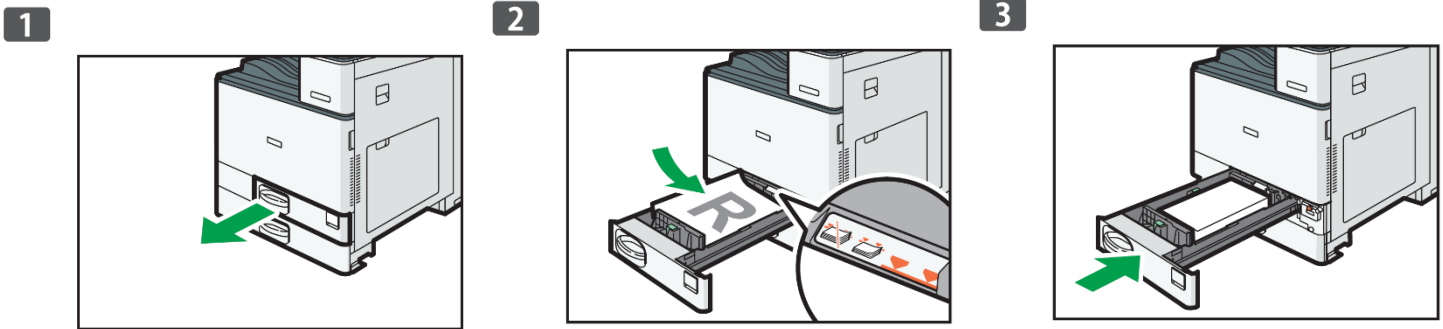

- If using tray 1, open the paper tray and load media with the print side face up
- Ensure the media locks in underneath the guides before closing the cassette.
- Ensure the paper stack does not exceed the upper limit mark inside the paper tray.
- ⚠ Excess stacking can cause paper jams.
- Be sure to load more than a few sheets in this tray, or multiple sheet feeding may occur.
- Straighten curled or warped media before loading.
- Various sizes of media can be loaded – simply adjust the positions of the side fences and end fence to match. Once loaded, carefully push the paper tray fully in.

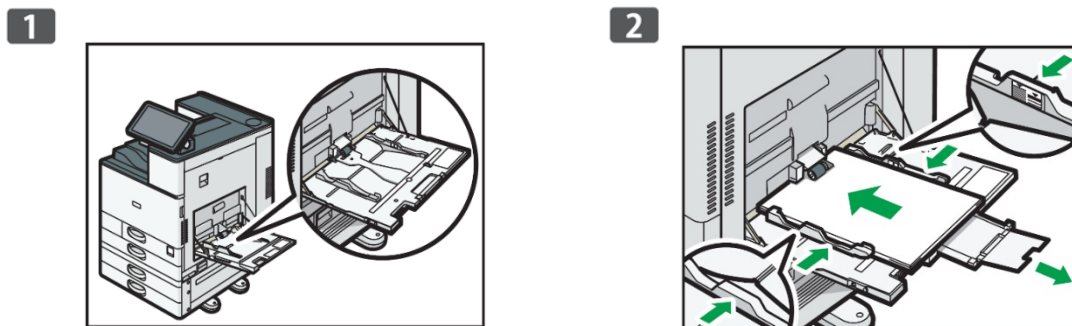

- If using the bypass tray (suggested for transfer media), load the media face down until you hear a beep and align the media guides to match the media size.

# Loading Banner Media (optional feature)

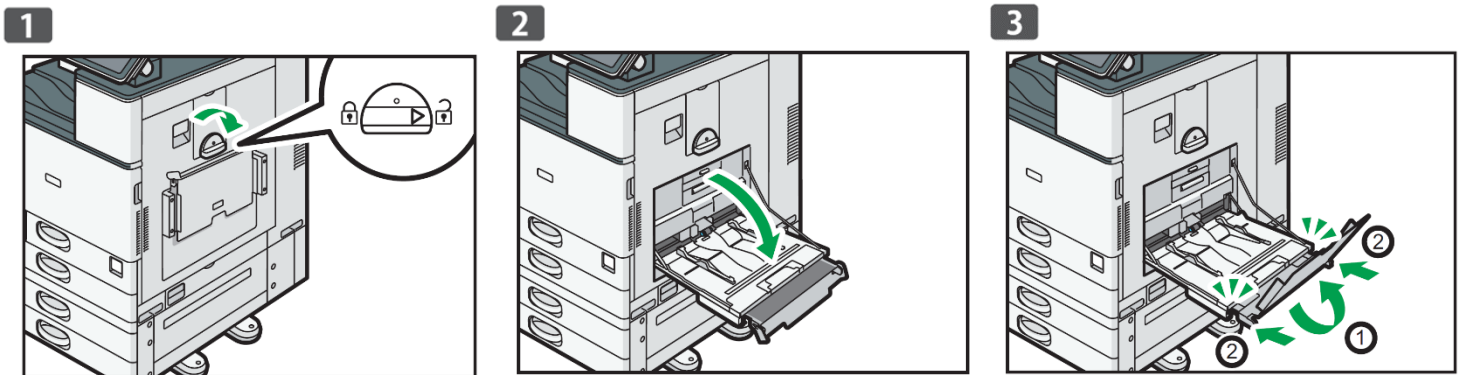

**⚠** It is possible to feed banner media manually. However, it is recommend to purchase the optional banner media tray for higher volume printing.

- To open the banner media tray, turn the lock knob clockwise until its triangle mark stops at the unlock mark. Be careful that your hand does not hit the banner paper guide tray when turning the knob.
- If you cannot turn the knob, turn it while pushing the banner paper guide tray toward the machine.
- Hold the handle in one hand while supporting the back of the bypass tray with the other hand, and then open the bypass tray slowly.
- Open the bypass tray until it is parallel to the floor. Raise the banner paper guide tray, and then insert it into the bypass tray until it becomes stable.



- Load the paper face down until you hear the beep.
- Align the paper guides to the paper size. If the guides are not flush against the paper, images might be skewed or paper misfeeds might occur.
- Open the subtray, and then raise the minor banner paper guide tray. Set the leading edge of the paper according to the paper size.
- When using paper that has a horizontal width of 1,200 mm (47.3 inches), curl the paper so that its leading edge touches the minor banner paper guide tray.



7

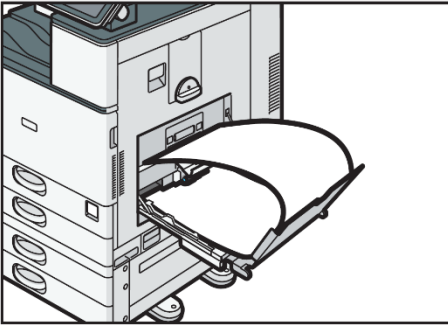

8

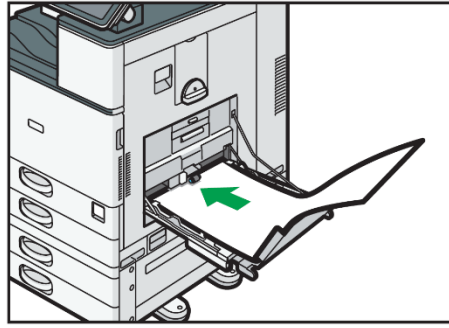

9

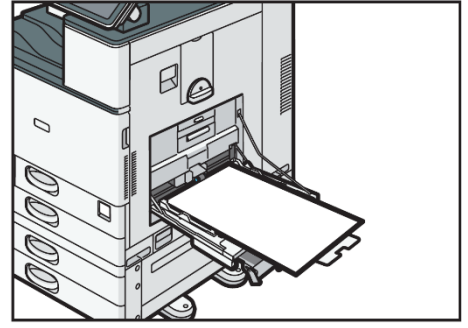

- When using paper that has a horizontal width of 900 mm (35.5 inches), curl the paper so that its leading edge touches the side of the machine.
- When using paper that has a horizontal width of 457.2 – 900 mm (18.00 – 35.5 inches), set the paper so that its leading edge protrudes from the banner paper guide tray.
- When using paper that has a horizontal width of 148 – 457.2 mm (5.83 – 18.00 inches), set the paper as loading paper into the bypass tray.
- You can load up to 10 sheets of paper that has a horizontal width of 457.2 – 1,260 mm (18.00 – 49.60 inches) into the banner paper guide tray.
- When loading multiple sheets of paper into the banner paper guide tray, be sure to load them as individual sheets and not in a stack.

## Closing the Banner Media Tray

- Remove any paper that is loaded.
- Fold the subtray up.
- Slide the paper guides outward to the maximum width.
- Fold up the banner paper guide tray.
- Hold the handle in one hand while supporting the back of the bypass tray with the other hand, and then close the bypass tray slowly.
- Turn the knob counter-clockwise until its triangle mark stops at the lock mark.

# Removing Jammed Media

- To prevent misfeeds, do not leave any torn scraps of paper inside the machine. If the error message remains displayed even after you remove misfed paper, fully open the front cover, and then close it.
- When removing jammed paper, do not touch the parts with a label indicating 'hot surface'.
- Do not remove the fusing unit. Doing so will result in loss of print quality.
- To remove paper that has not been fed into the fixing section correctly, remove the jammed paper through the underside of the fusing unit. If the jammed paper cannot be removed through the underside of the fusing unit, remove it from the top.
- If you are using the banner paper guide tray attached to the bypass tray, the paper loaded in the bypass tray may fall out when you remove jammed paper. First remove the paper loaded in the bypass tray, and then open the right cover.
- If a misfeed occurs, remove the jammed paper by following the procedures indicated in the animation that appears on the screen and the sticker or sheet inside the front cover.
- The misfeed inside the machine will correspond to the letter in the graphic below, displayed on the control panel.

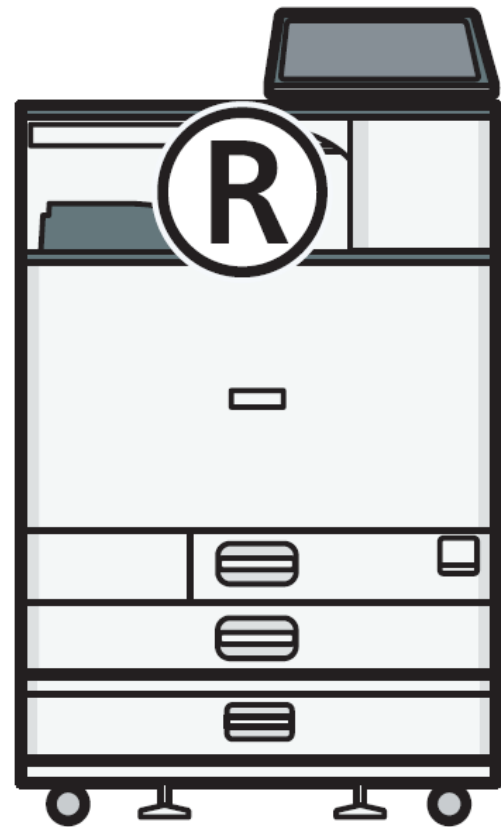
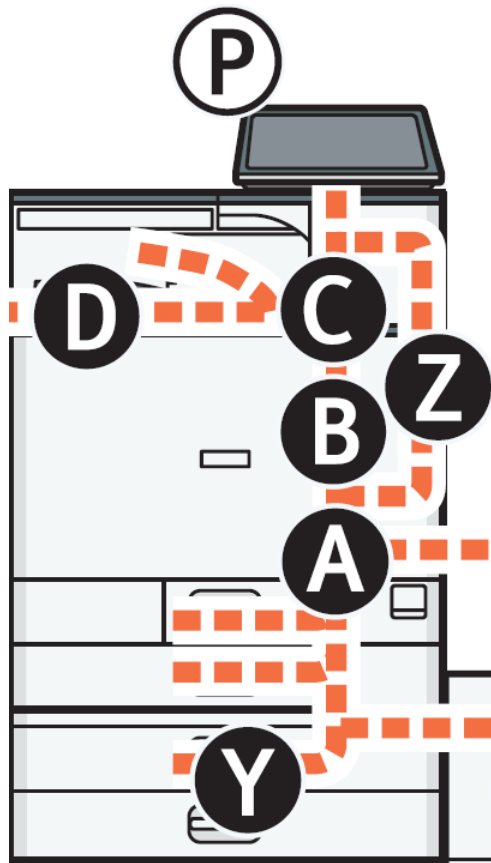

# IColor™ ProRIP Software Introduction



Use the IColor™ ProRIP software to print white as an overprint in one pass. This professional version is designed for higher volume printing with an all new interface. Design files can be printed directly from your favorite graphics program, as well as imported directly into IColor™ ProRIP.

The IColor™ ProRIP software allows the user to control the spot white channel feature, as well as spot color overprinting, where white is needed as a top color for textiles. No need to create additional graphics with different color configurations – the software does it all – and in one pass. Enhance the brilliance of any graphic with white behind color.

#### **Print and Transfer onto:**

- Natural and synthetic fabric (Light and Dark)
- Mugs and ceramics
- Light, dark and clear labels
- Leather
- Light and dark paper stock
- Glass
- Acrylic
- Wood
- Metal
- Window Cling
- Banners
- And much more!

#### **Create unique items – The possibilities are endless!**

- T-shirts and sweatshirts
- Aprons
- Corporate logo shirts
- Mouse pads
- Sports apparel
- Jackets
- Tote bags
- Tattoos
- And much more!

The most important point of the IColor™ ProRIP software is that it allows colors to be put down in layers. Regular printer drivers only concern themselves with what the eye sees on the top layer, the RIP allows you to separately control each layer, thus giving you the ability to control not only what you see, but what is behind that top layer (typically the white layer).

Print white as an overprint in one pass for reverse printing (typically used for transfer printing of textile and hard surfaces), where white is needed as an overprint, applied on top of all the other colors. When the image is pressed to the garment, the transfer sheet is flipped over and the white becomes the underprint. This is especially important where images have half tones and 100% transfer of the image can be problematic, or when there is white in the image that needs to show through on dark colored garments.

White toner performs the following functions:

1) To produce the color white on a dark garment.

2) To fill in the halftones on lighter images so that there is enough toner on the page to fully transfer to your garment or to pull all the B adhesive.

 This second point is the most important one and the reason why you cannot simply use a CMYK printer for transfer printing. Also, this is why you **MUST** use the color white all the time (assuming your image has some halftones in it). Even when printing on a white garment and there is no white at all in your artwork. This is the biggest misconception with new users.

 Don't make that mistake, always use the white toner cartridge for any type of transfer printing!

# IColor™ ProRIP Software Installation

- Make sure all other programs are closed and **virus software is uninstalled.**
  - ⚠ Failure to uninstall virus software can lead to problems with installation and/or use of software.
  - ⚠ If you keep the virus scan software active after installation, you must add the ProRIP to the 'safe programs' list or issues with ProRIP software can result. Windows Defender is the only program which, to date, has not affected the functionality of the ProRIP.
- Plug in the included dongle into a free USB port on your PC. This dongle contains all of the software, manuals and documents for your printer and software and also serves as your license key.
- The use of a dedicated printer driver is not provided, nor is it necessary. The ProRIP software contains the driver for this machine, and all printing should be done directly from the ProRIP software.
- You have the choice of using the following connections: USB or Wired Network
- For front panel internet access, Wifi is standard and should not be confused with printing via wifi. It is not necessary if running the printer via wired network.
- NOTE: It is suggested to copy all of the installation files located on the USB drive to a folder on your computer for safe keeping and ease of installation.

⚠ The IColor™ ProRIP dongle must be installed at all times when installing or running the program.

- 1) Navigate to the RIP setup folder on the ProRIP dongle or on your PC if you've copied these files. Right click on the setup application file and 'Run as administrator'.
- 2) Select the language for installation and click 'OK'.

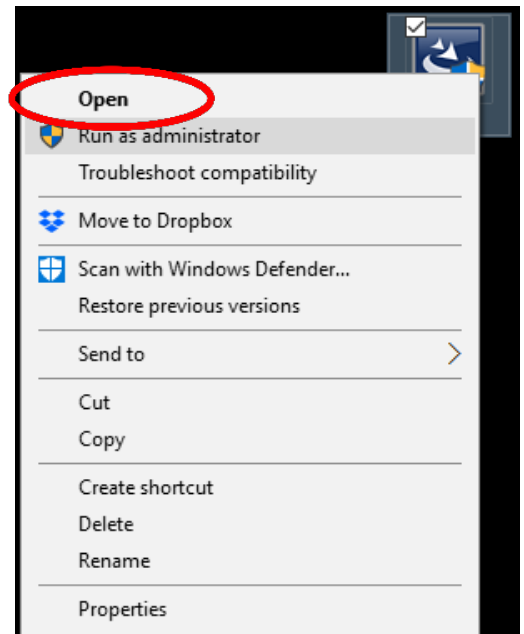
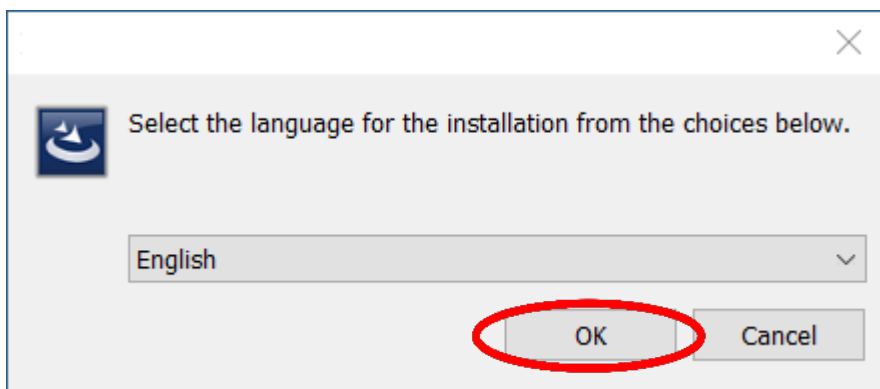

- 3) You will be prompted to insert the USB dongle before proceeding with the installation. If already inserted, click 'Next'. (There is only one dongle shipped with your system, and can look like either of the types represented below).

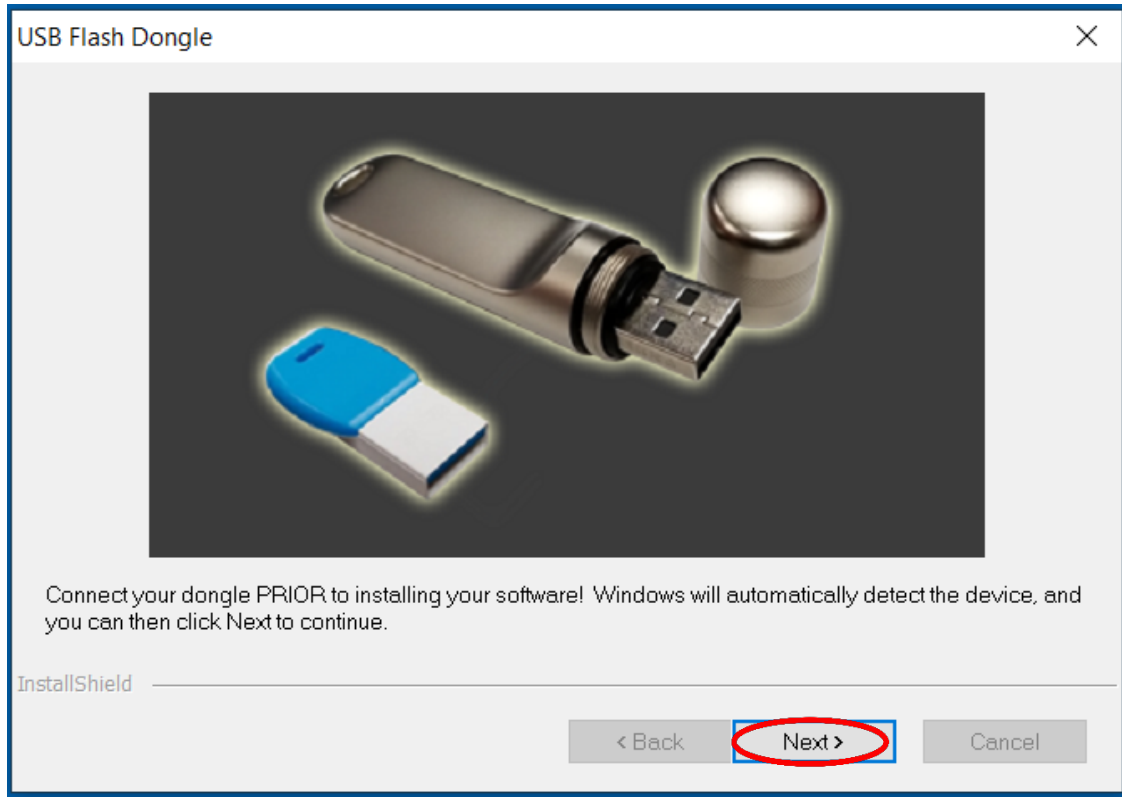

**IMPORTANT: This USB dongle is your license key. Ensure that it is not lost or broken, as UNINET cannot replace it without a charge. You cannot use the software without it installed in your PC.**

- 4) Select either the 32 bit or 64 bit application (dependent upon your version of windows). Accept the terms of the license agreement and click 'Next'.

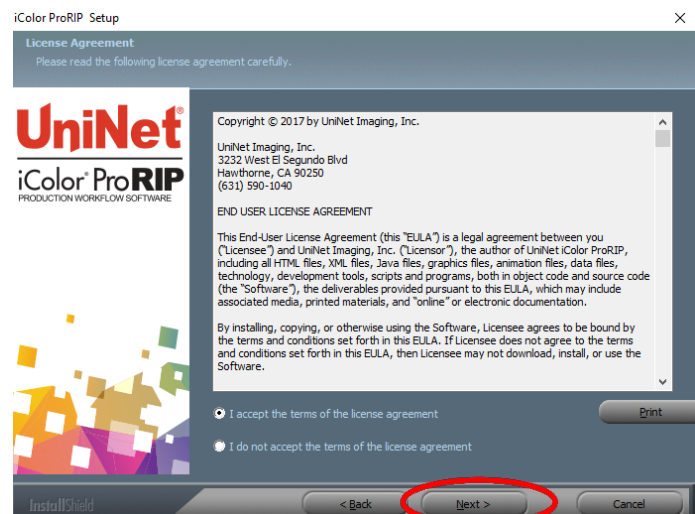

5) Choose 'Full install of IColor™ ProRIP' and click 'Next'. Click 'Next' again to accept the installation folder.

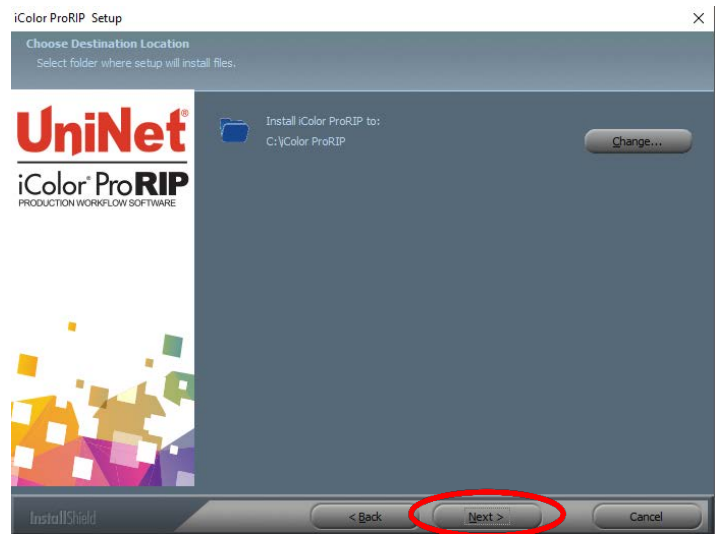
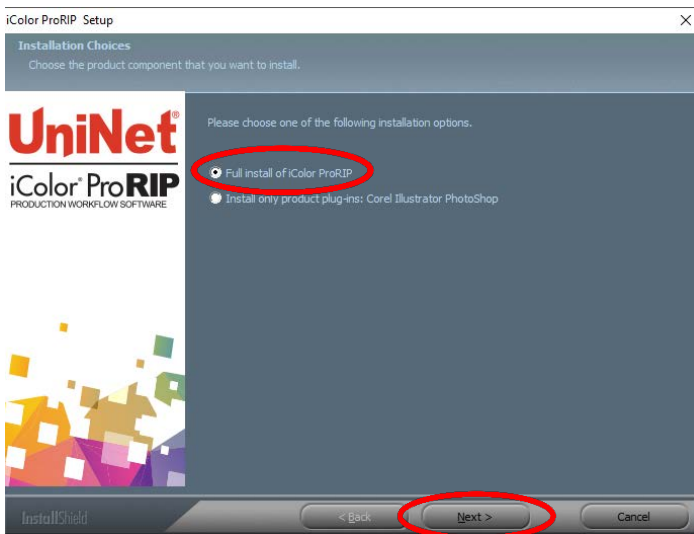

6) Click 'Next' to allow the creating of the IColor™ ProRIP Program Folder and the installation will begin.

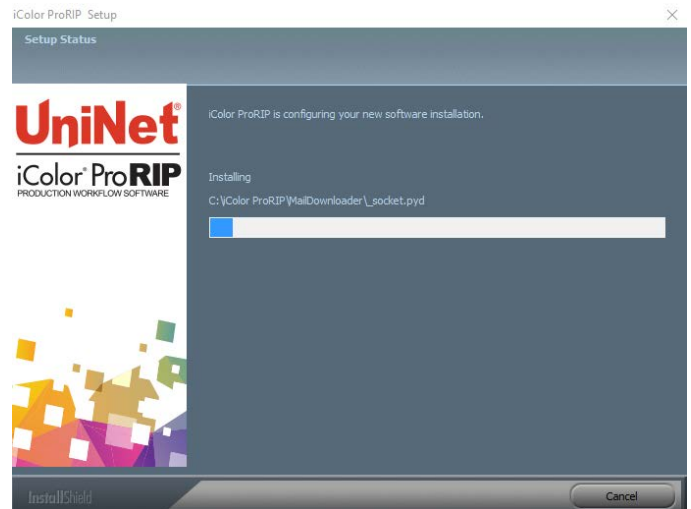
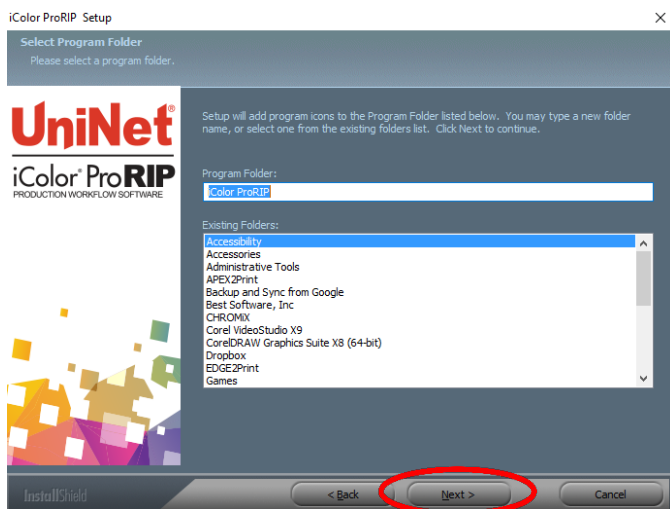

- 7) If not already installed, you will be prompted to install .NET Framework, which is a necessary component to the ProRIP software. Accept the license terms and click 'Install'. Once the InstallShield Wizard is complete, click 'Finish'.

 This installation normally takes several minutes to complete.

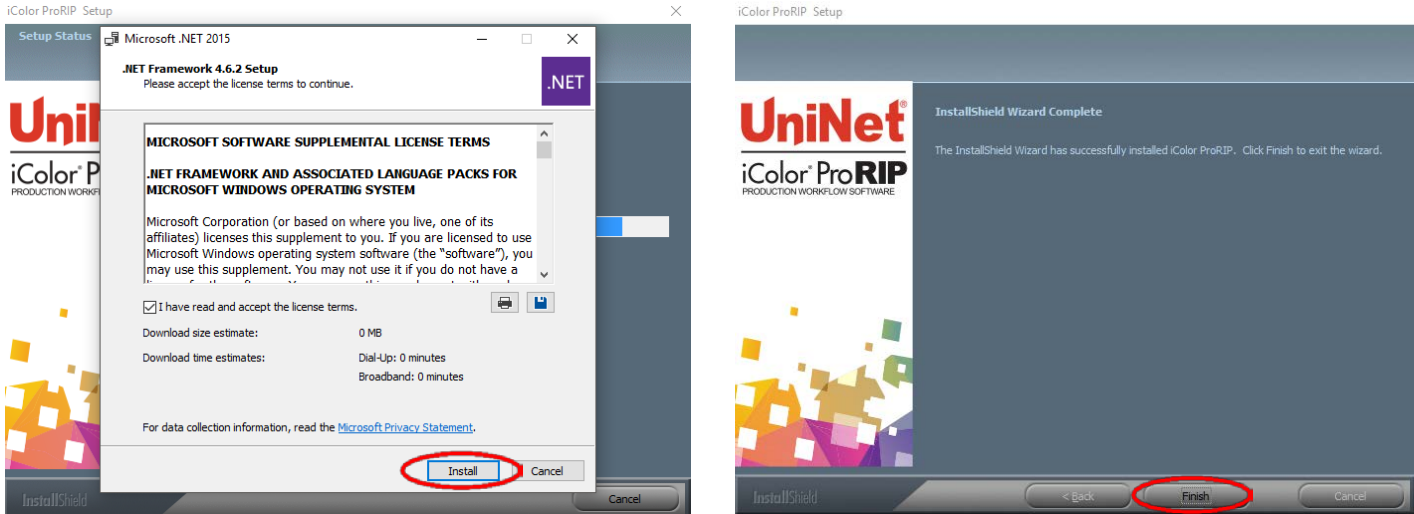

## ProRIP First Time Setup

- 1) Be sure the IColor™ ProRIP dongle is installed and you are connected to the internet.
- From the Windows Start menu, choose **All Programs >> IColor™ ProRIP** or double click on the desktop icon that was created upon installation. Launch the program.
  - Create a shortcut if desired for quicker access later.
  - Confirm first time setup by setting your preferred unit of measure and decimal places. This can be changed later under **Tools >> Options**.

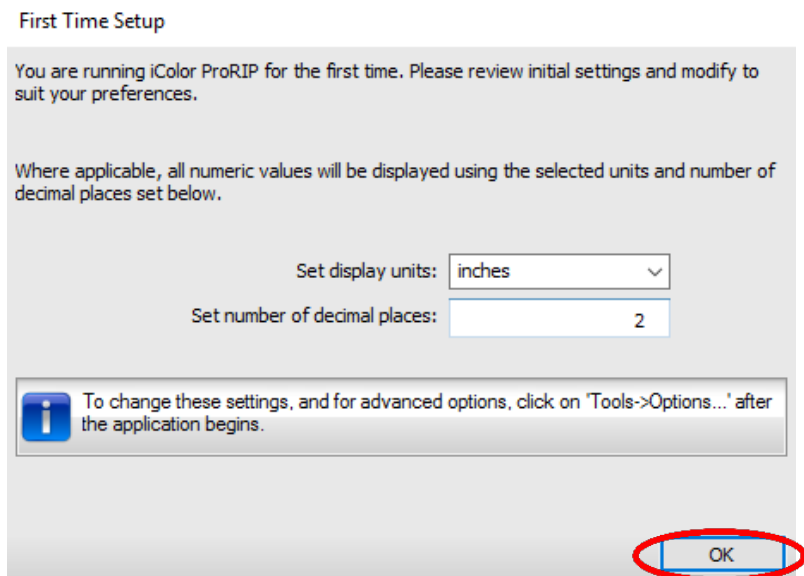
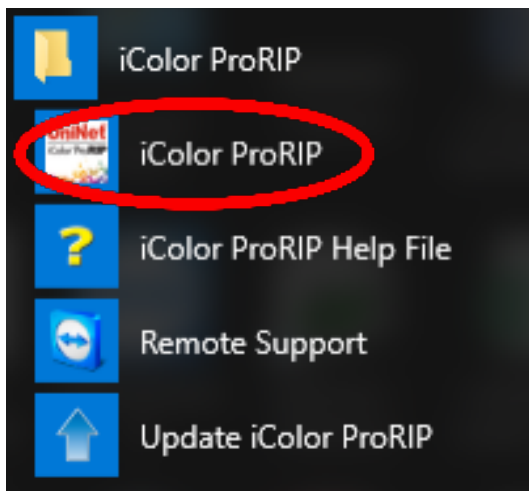



- 2) Once the ProRIP opens, the Queue Wizard will begin the installation of the support files for your IColor™ printer. Click 'Next' and then 'Install Printer'.

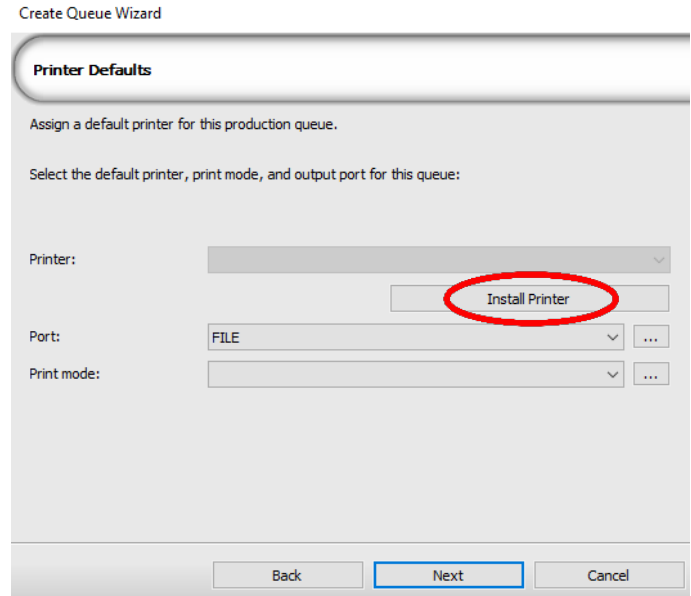
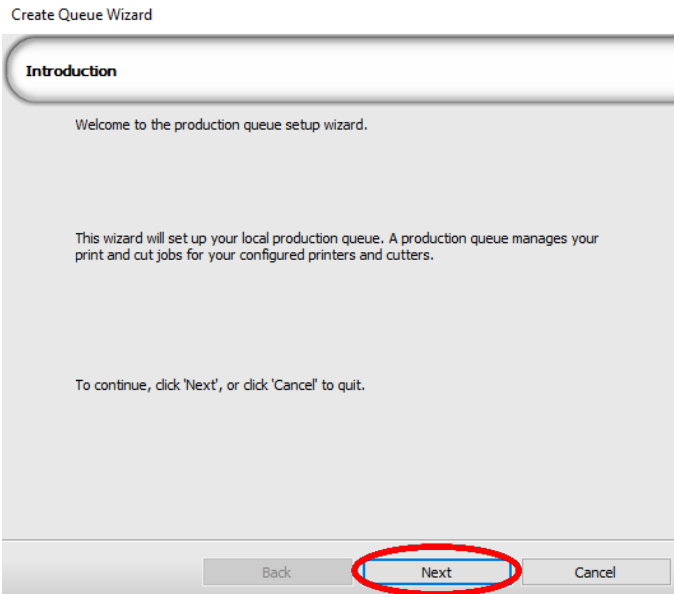

- 3) Select the appropriate printer from the support menu (in this case, choose the IColor™ 800W). Click 'OK'. Then click 'Next' to continue the installation.

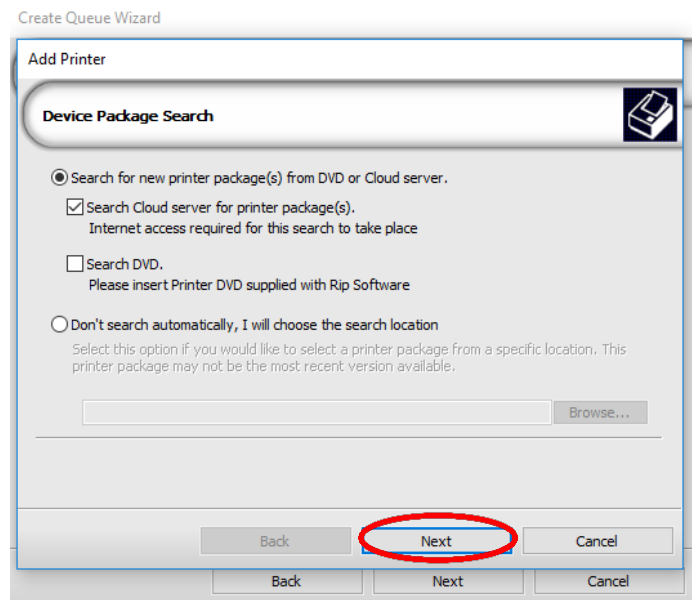
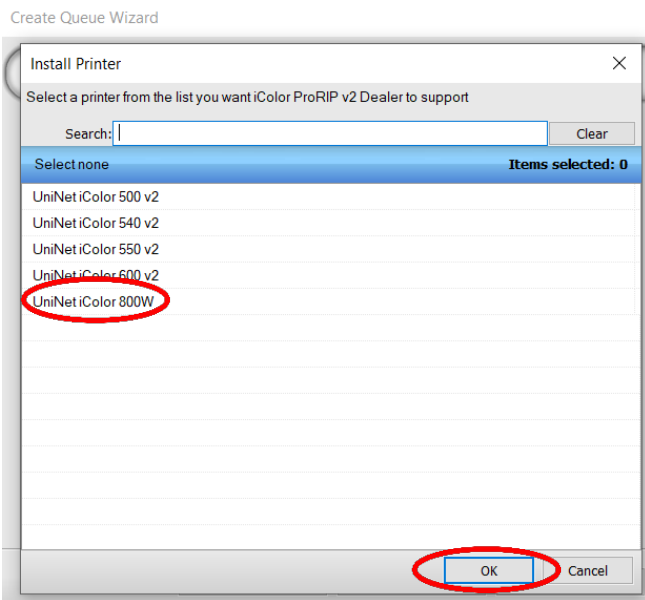

4) Click the 'Port Setup' dropdown and select how your printer is connect (Network or USB).

⚠️ You must complete this step or you will not be able to print.

5) If connected via network (recommended), choose TCP/IP. If connected by USB, choose the printer as identified in the drop down.

⚠️ For USB connections, do not choose the port 'Printer\_USB-001+'. The proper port will also have the printer name in the description.

⚠️ All other ports will update automatically, it is only necessary to do this for one queue.

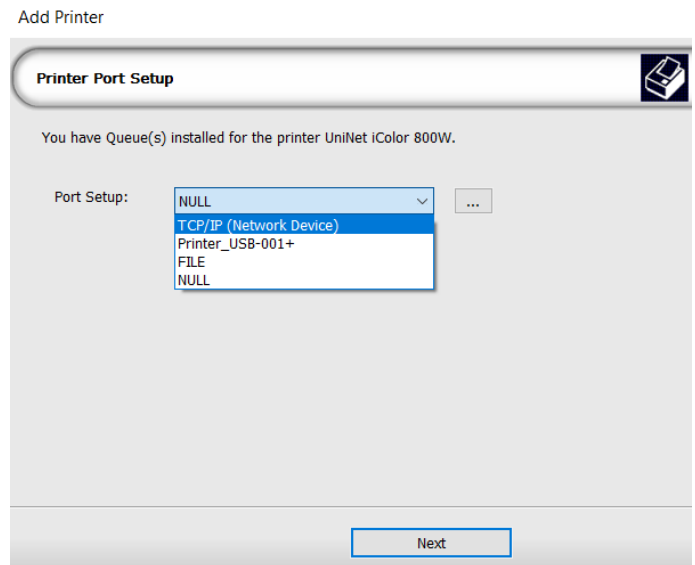
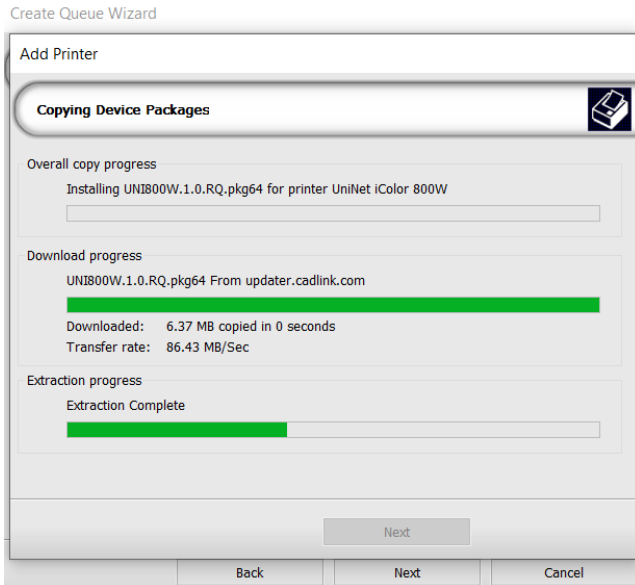

6) If connected via network, once TCP/IP is selected, the software will poll your network for available printers. Select the proper iColor™ printer. Note that the IP address of the printer is displayed.

⚠️ Be sure to set a static IP address for your printer so that the IP address does not change later. If this happens, you will have to repeat this step.

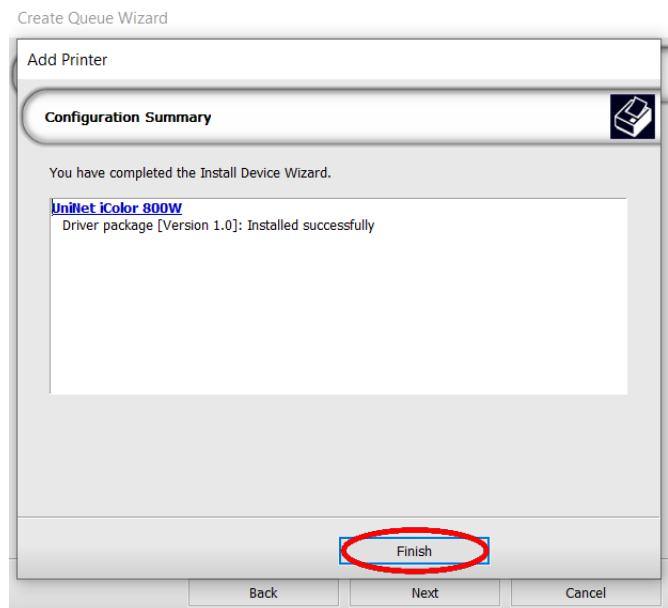
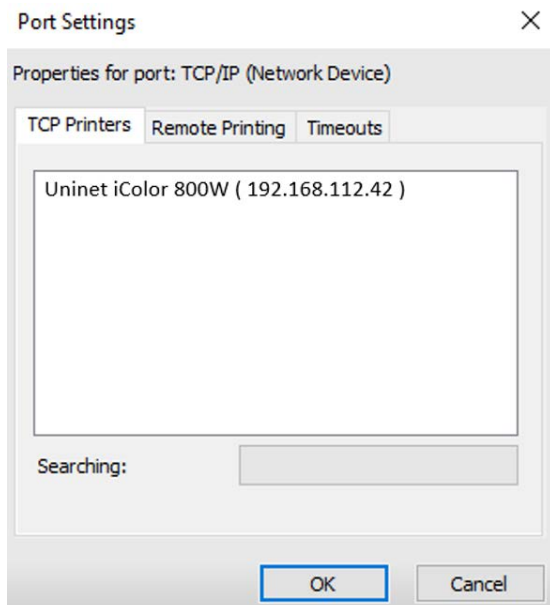

7) If you need to change or reset the ports in the future:

Click **Queue >> Manage Queues** to view, update or change the port settings.

**⚠** Port settings will reset when the queues are updated so you will have to do this from time to time.

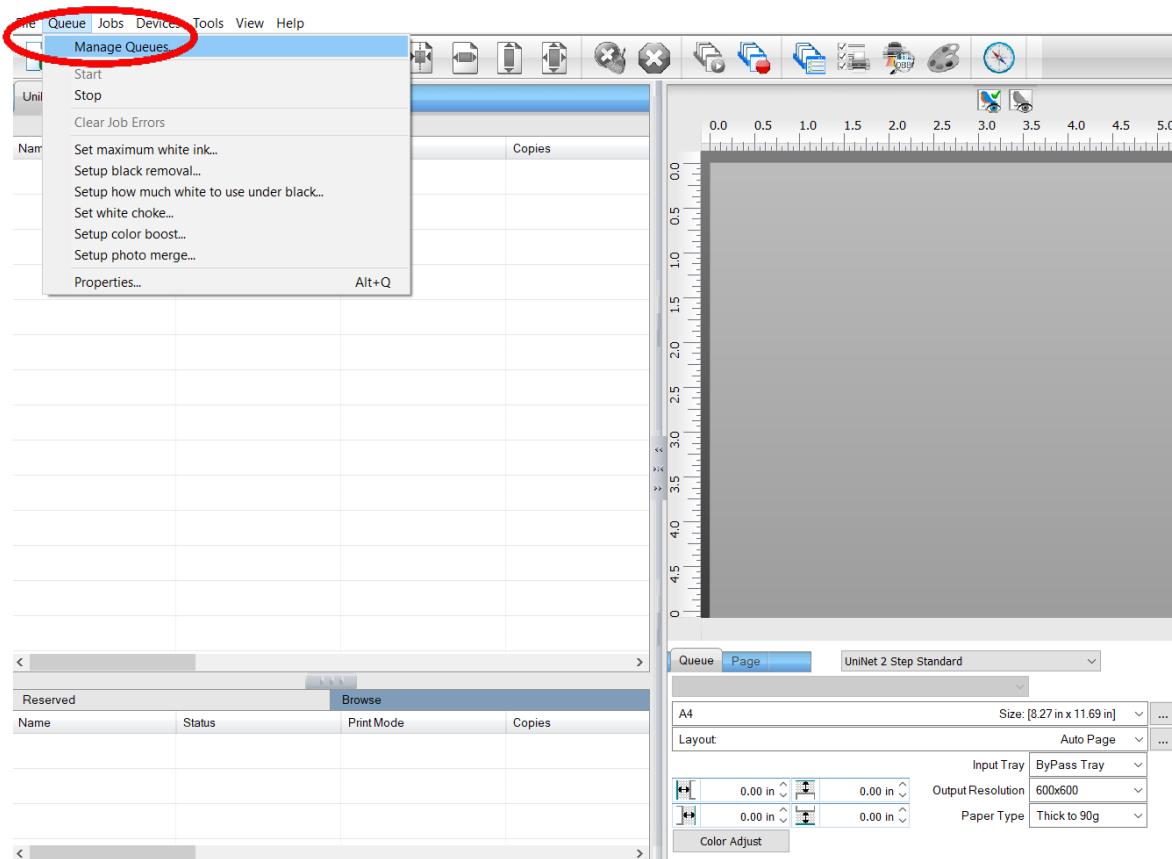

8) In the 'Port' drop down menu, choose the proper port. If connected via network (recommended), choose TCP/IP. If connected by USB, choose the printer as identified in the drop down. All other ports will update automatically, it is only necessary to do this for one queue.

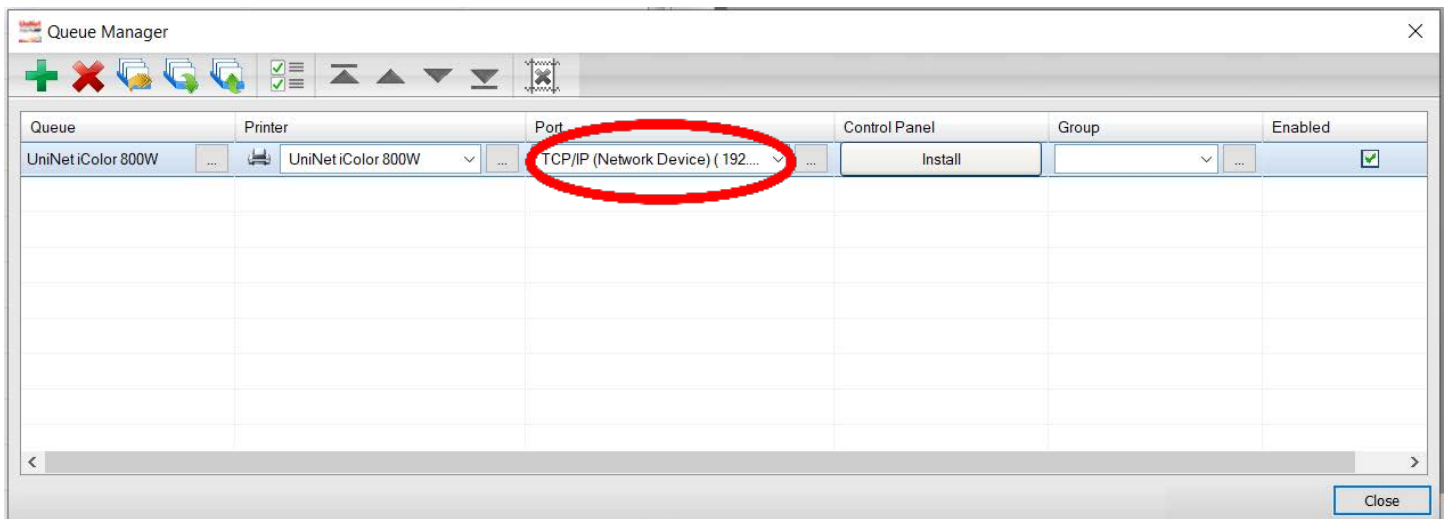

- 9) If connected via network, once TCP/IP is selected, the software will poll your network for available printers.
- Select the proper IColor™ printer. Note that the IP address of the printer is displayed.
  - Be sure to set a static IP address for your printer so that the IP address does not change later. If this happens, you will have to repeat this step.

### Setting a static IP:

On the LCD screen of the printer, click **User Tools>>Machine Features>>System Settings>>Interface Settings>>Machine IPv4 Address**. Click 'Specify', then you can manually add your desired IP address. Once complete, click OK and exit.

**⚠ Do not alter any other settings on the printer itself!**

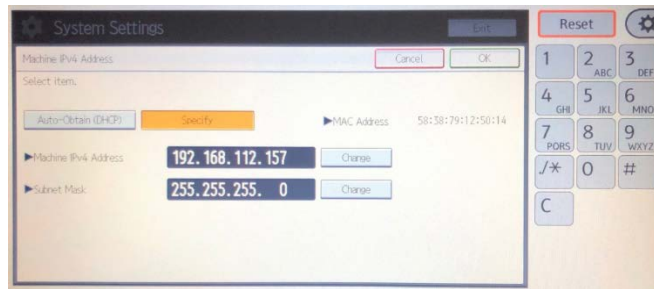

- 10) To begin, select the media type and the size you wish to use under the queue tab at the bottom right of the screen. The input tray and paper type will be automatically set based on the media selected. UNINET suggests that you do not alter these settings.

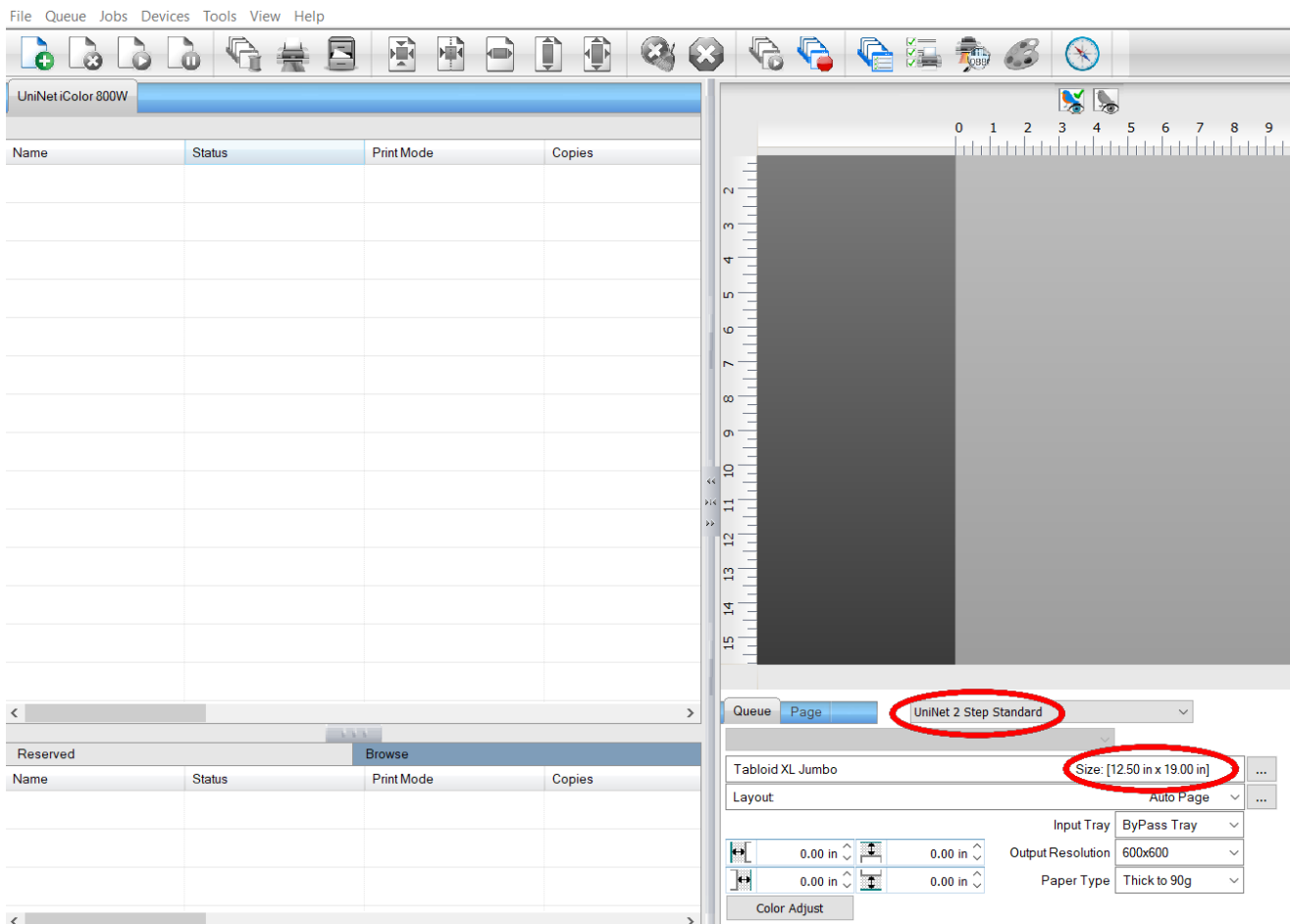

11) Import the desired graphic by clicking the 'green plus' icon and navigating to the proper folder.

- You can also import by clicking **File > Import File**, or simply dragging and dropping your file into the queue.

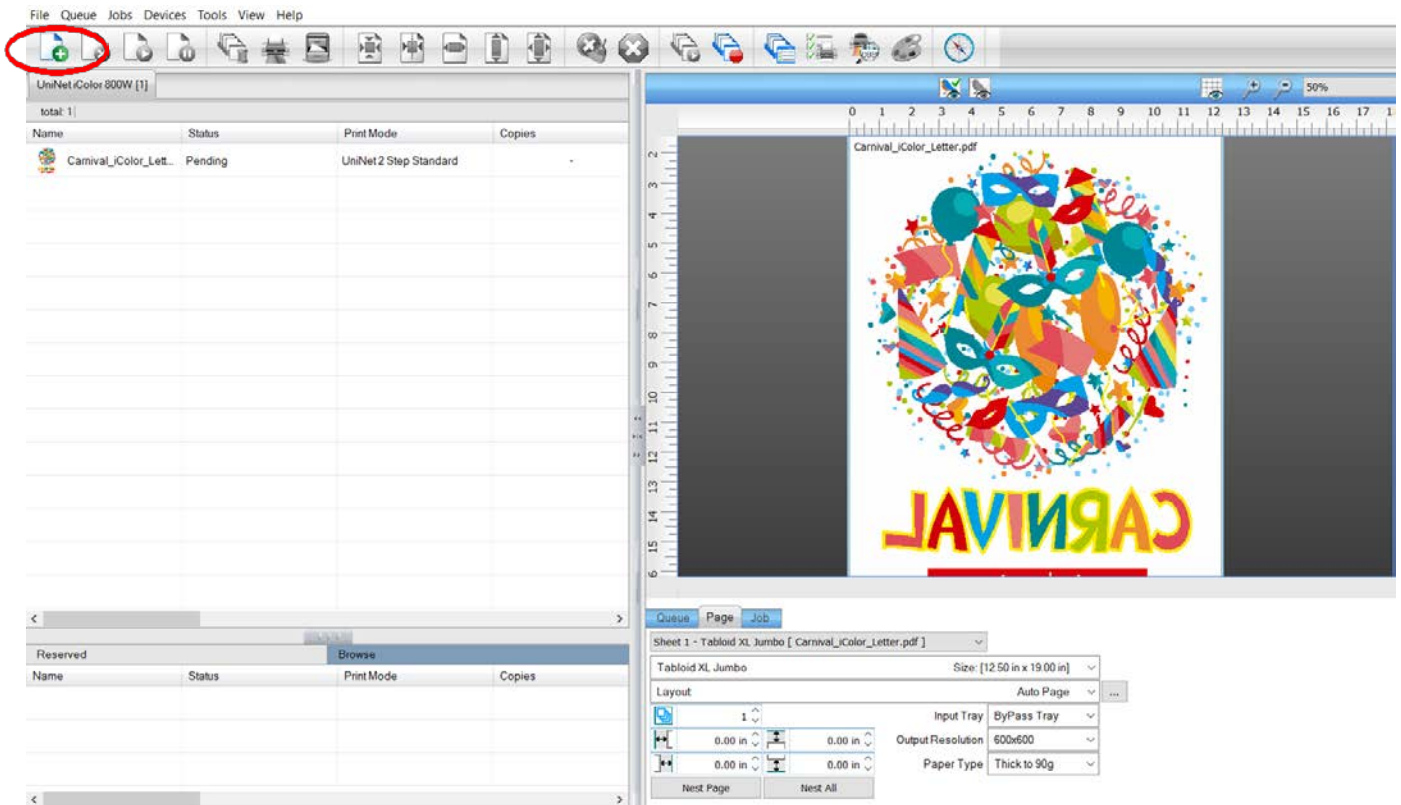

12) There are preloaded images that can be used to print a test page.

- Click **Devices >> Print Test Page** to see the choices. It is suggested that you print a test page upon completion of the setup to confirm the printer has been properly installed. Use [Shift] and [Ctrl] to click multiple pages), and then click OK.
- More about the uses of each page can be found in the Help Topics file within the ProRIP program as well as the ProRIP User Manual.

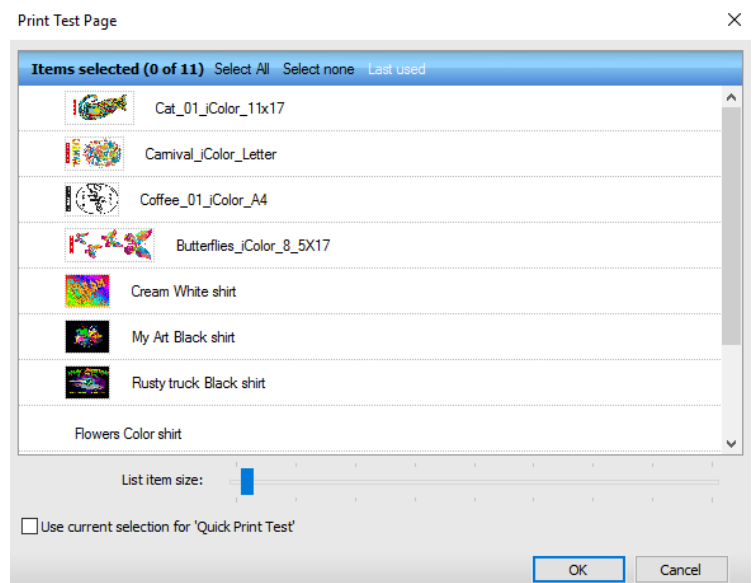
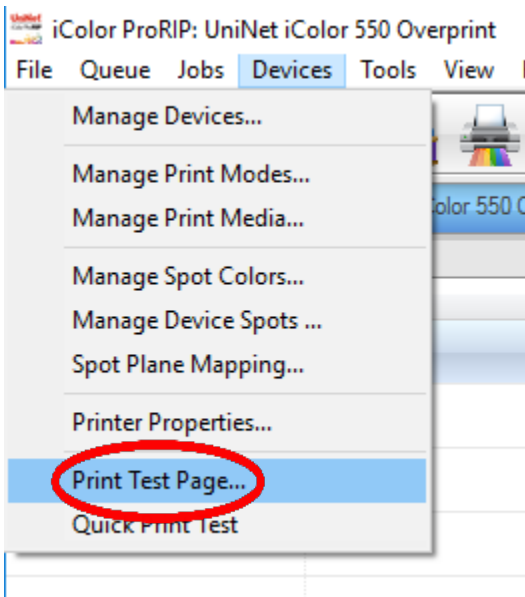

# Using the ProRIP Software (Summary)

Once your image is loaded, take note of the preconfigured settings relating to the media being used in the printer.

The 'Queue' tab shows the size of the media that will be used, where to load the media into the printer and the paper type setting recommended.

Each media type will contain this preconfigured data to make your printing experience as easy as possible. Overriding these settings could yield undesirable results.

To alter the color settings, click on 'Color Adjust' and adjust as needed. 'Coverage %' represents the amount of white/clear toner overprint or underprint (depending on which queue is being used).

The 'Vary hole size in areas of transparency' option allows for rasterization of colors that fade into nothing and to retain partial transparency. It is suggested that this option is left on, as it will only apply itself where it's needed.

'Choke' dictates how much the overprint white layer is pulled in under the colors. The higher the number, to more it's pulled in (to avoid a white outline around your graphic).

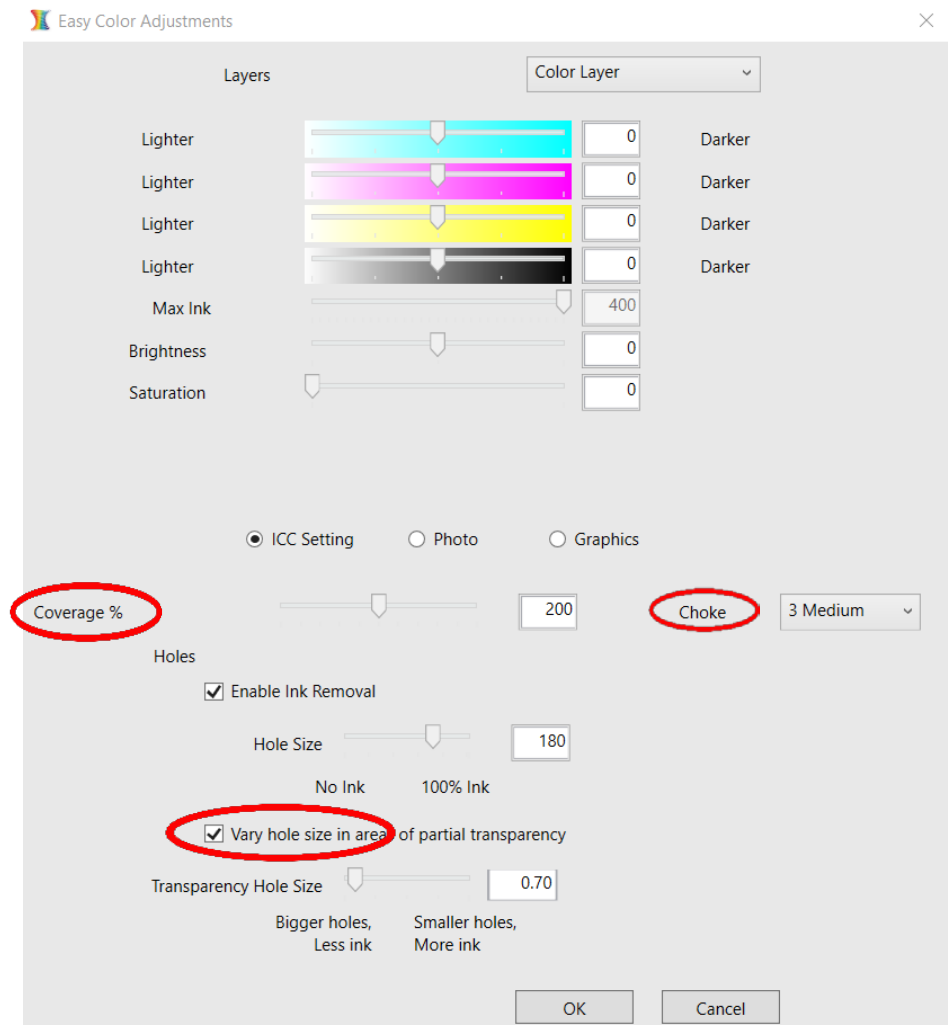
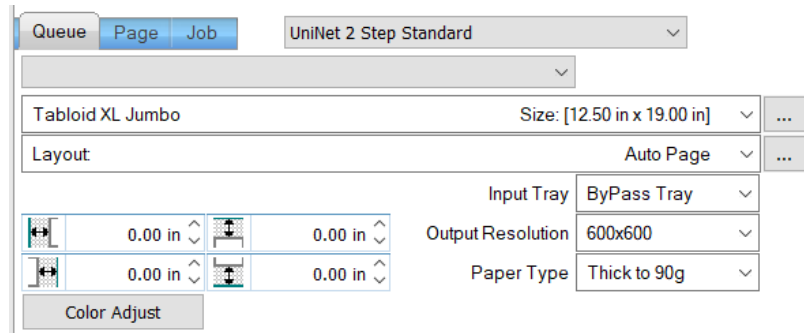

The 'Page' tab offers the ability to print multiple copies and nest images.

You can also adjust the size of the image to fit your media here (and in the Queue tab).

The 'Job' tab allows you to lock the proportions of your image to maintain the aspect ratio.

Here you can also mirror, rotate and invert the image, as well as adjust the margins of the print if necessary.

Note that the mirror function is automatically on for any image loaded into the overprint queue.

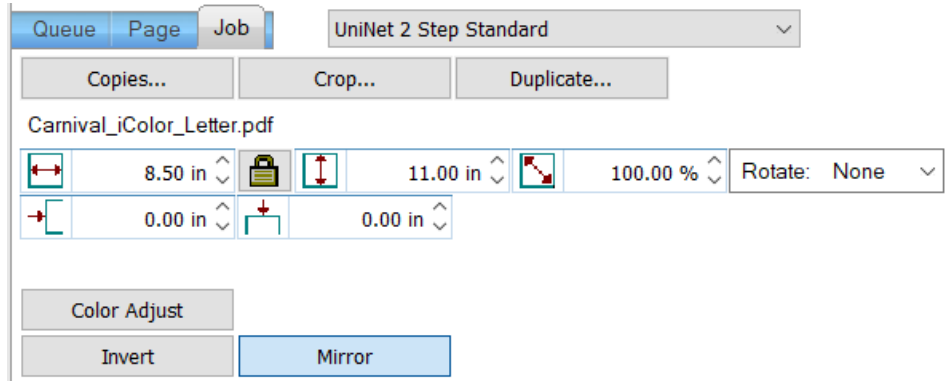
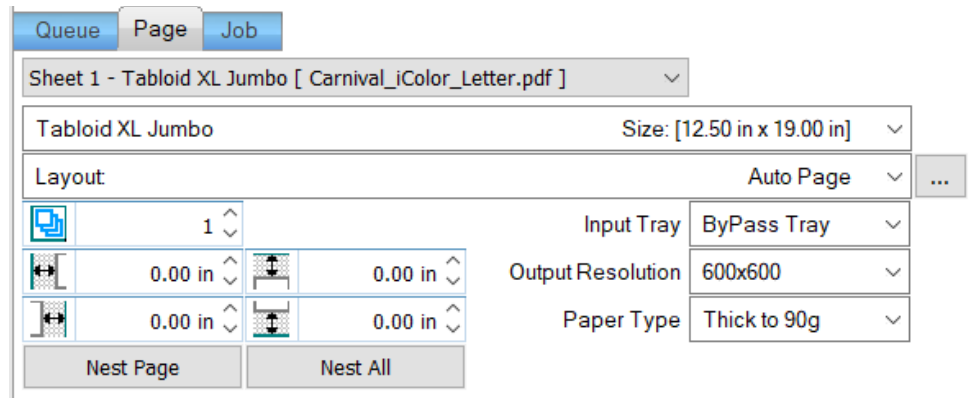

- You can also adjust the size of any image by dragging and dropping the corner of the image in the preview pane.
- In this example, where we have a letter sized image placed on an A4 artboard, the red bar to the right of the image represents the portion of image that is outside the print margins. Be sure to resize to eliminate this bar before printing.

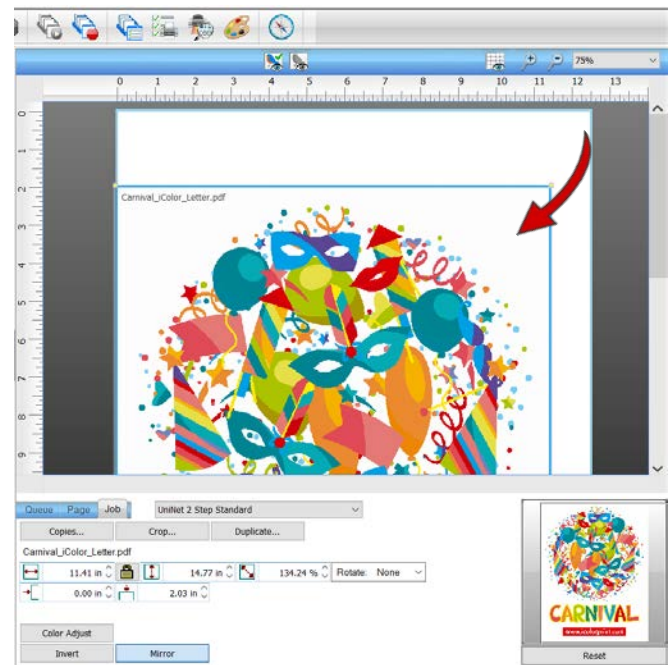
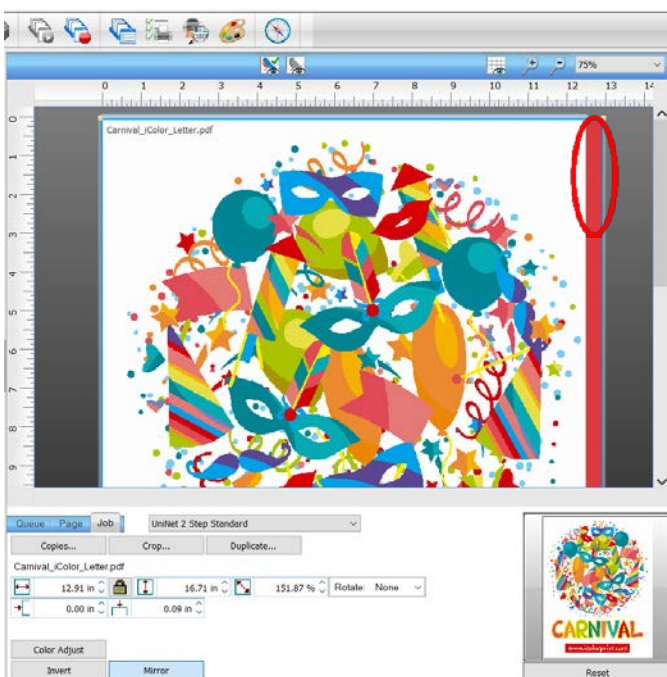

Adjustments can also be made by using these icons at the top of the screen.

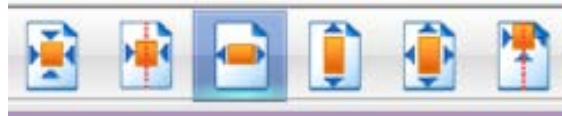

When ready, click the 'Print' icon to print your graphic.

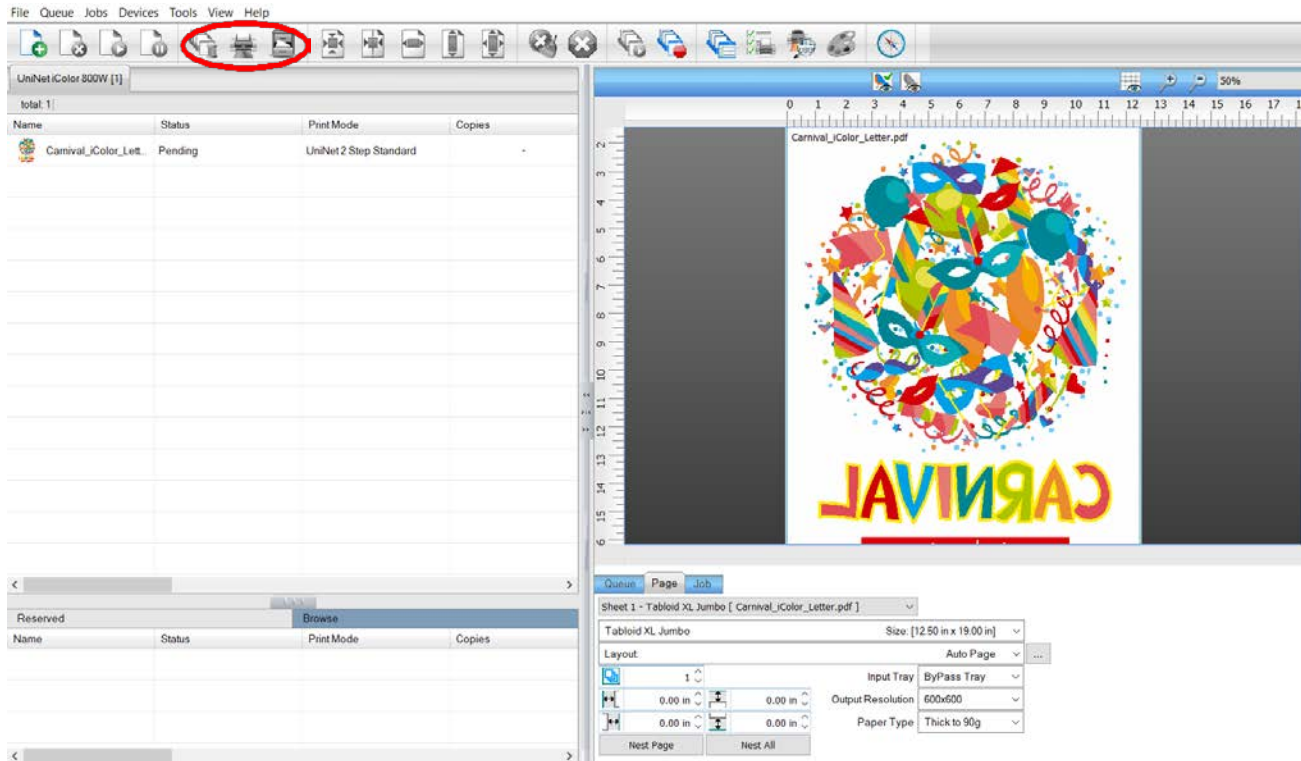

**⚠** If you encounter any of these issues when printing from the RIP, please refer page 19, step 7 to set the proper port in Queue Manager.

- Port Failed to open
- Holding
- Prompt to save rather than print
- Unknown Error



Once the print has completed, the job will be archived in the reserved area for 7 days. If you wish to reprint that job, drag and drop the job from the reserved section into the queue.

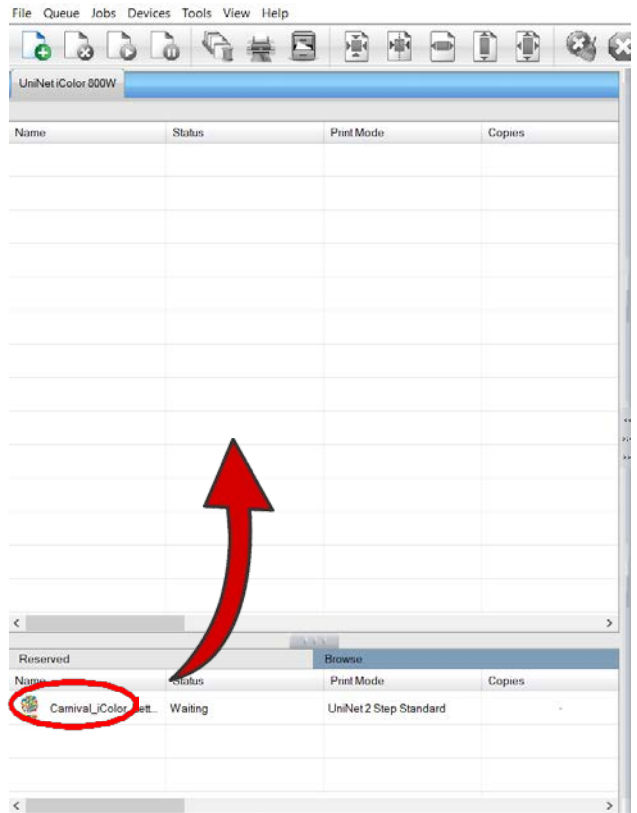

To lengthen the amount of time a job stays in reserve, click **Queue>>Properties**. Then click 'Job Reserve' and set the 'Auto Clean Reserve' time frame. Unclick to keep jobs in reserve forever.

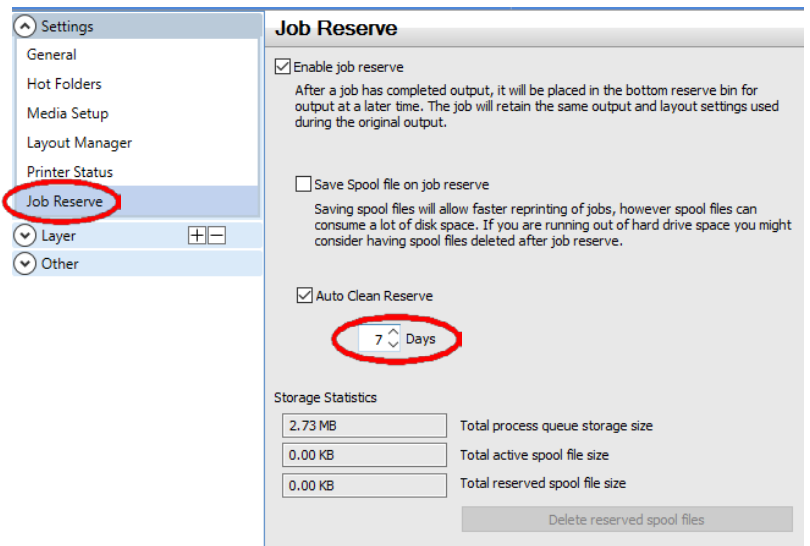
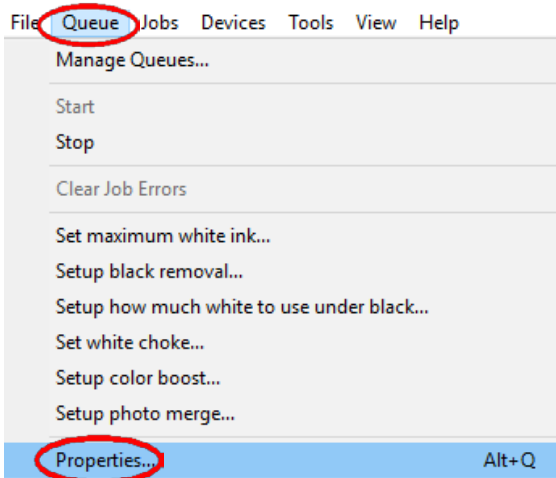

After a particular job has printed, it will be 'closed'. This means that it was rendered by the software so that the next time you print, the processing time will be minimal. If you need to make any changes to the print job before printing, you must 'open' the job. Otherwise, just reprint as needed (processing time is faster when already rendered).

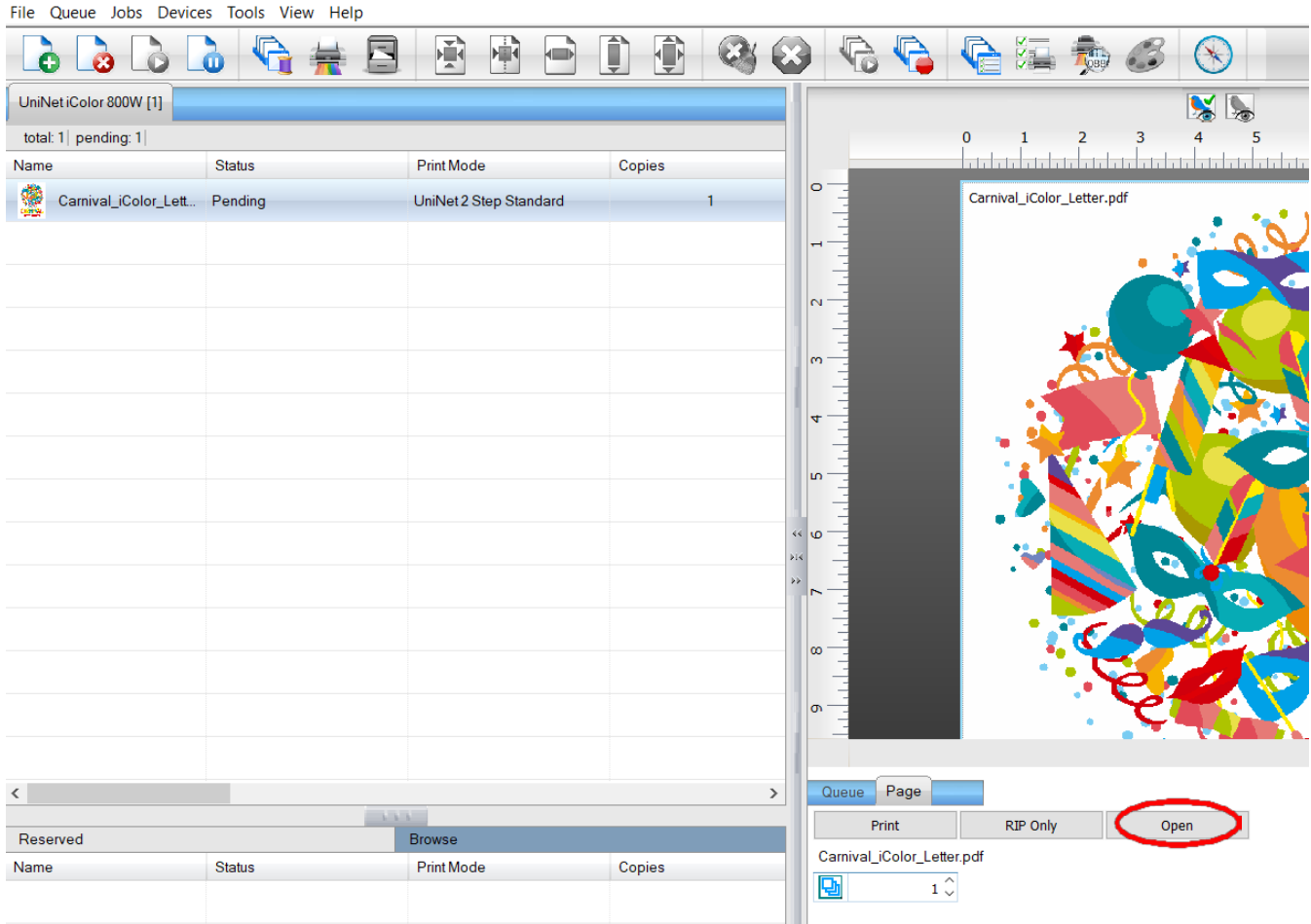

For more detailed instructions for the IColor™ ProRIP software, please consult the IColor™ ProRIP User Manual.

Visit [www.icolorprint.com/support](http://www.icolorprint.com/support) for the most updated written and video instructions on the IColor™ ProRIP software.

# Achieving the darkest black color

To obtain the darkest black print on your IColor™ 800W and IColor Transfer Paper (except IColor Select Paper), set the color of the black portions of your artwork to 100% C, 100% M, 80 – 85% Y. It may be necessary to do this from the RIP, as some file formats may convert differently than others once imported.

For IColor Select 2 Step Transfer Paper, set the color of the black portions of your artwork to 90% C, 90% M, 80 Y.

- 1) Load your image into the IColor™ ProRIP as you normally would.
- 2) Click the 'Job Color Replacement' icon at the top of the screen.
- 3) Use the dropper to select the portion of the graphic you wish to modify.
  - In this case, the black artwork was imported with the wrong color codes as indicated by the input color fields and requires modification.

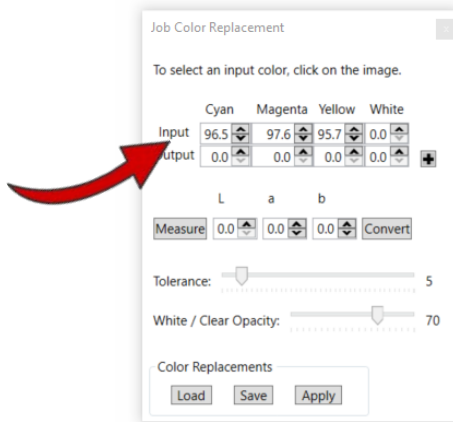

- 4) Enter the correct color code for black in the output fields and click the '+' icon, then click 'apply'.
- 5) Your artwork now has the correct color code and will print the darkest black color.

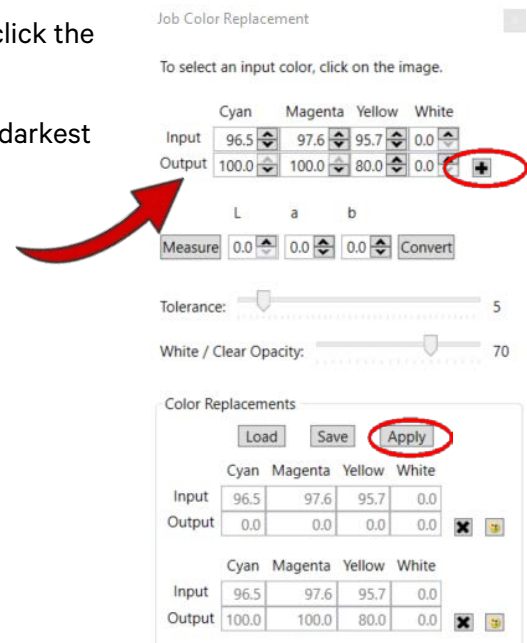



## Why use IColor™ SmartCUT?

SmartCUT allows owners of smaller width printers to gain the benefits of tabloid or larger sized printers.

SmartCUT is a user centric tool that is a key component to expanding the size constraints of popular print methods, especially as it relates to transfer printing commonly associated with garment decoration. This ground breaking application turns your letter / A4 sized printer into a tabloid 'plus' capable machine, allowing for the splitting and splicing of one graphic across two or more printed transfer sheets without seeing the seam!

Use any oversized graphic along with a transparent transfer sheet, and the software will split it in half along the most logical path. You can choose to have it split along dark or light areas, depending on the color garment you will be pressing onto. With this software, you can make large designs that are not possible with even the most expensive of printing systems because you can split up your graphic onto as many transfer sheets as you want.

SmartCUT can be used in tandem with any RIP software package and printer. It was designed from the ground up with ease of use as a paramount consideration. Most functions are automated to allow you to focus on finding the best starting point to split each job. Final results can be used on virtually any printer. White toner printers highly recommended.

SmartCUT supports many file types such as PNG, JPG, BMP, GIF and TIFF files.

The program works as an integral part of a decorating system, where the split pages are printed onto IColor™ Standard or Select transparent transfer media. The sheets are then lined up visually on the substrate through the transparent sheet.

Print and press onto plus size garments such as 2X, 3X, 4X. The ability to print designs that properly fill out these large sizes creates the opportunity for high value garments that can fetch a premium price. A very high percentage of designs used are virtually imperceptible by even those who know that a seam exists.

SmartCUT is more than just 'splitting software' – it's a RIP enhancement tool!

New features include:

- The 'Selective Masking Tool' allows you to point and click to rasterize or distress elements of your design based on color or shape.
- IColor™ ProRIP software integration for ease of use.
- The 'Real Preview' tool which applies the white adhesive behind the image (digitally) and then applies the image it to the color and texture of a shirt. The result is a much more realistic preview of how your image will look once pressed.

# Use Genuine UNINET IColor™ Consumables

Use only genuine UNINET IColor™ consumables. The use of incompatible supplies (toner, drum, transfer belts, fusers and registration assemblies) may cause damage to your printer not covered by your warranty. Contact your dealer to reorder supplies.

**⚠** Always replace toner and drum cartridges in the specified slot according to color or serious damage could result.

## Replacing toner and drum cartridges

### Supplies Replacement Guide

Printer Display Reads:	Replace:
Cyan low/out/empty	Cyan
Magenta low/out/empty	Magenta
Yellow low/out/empty	White
Black low/out/empty	Yellow

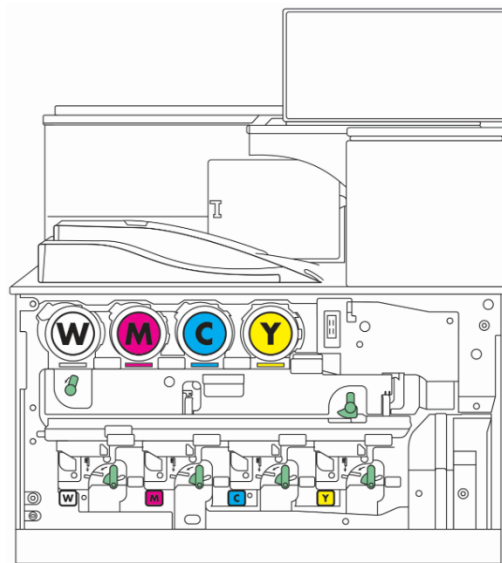

Be sure to follow the guide above. Do not rely on what the printer control panel displays!

The IColor™ 800W is not capable of White underprint® applications and cannot accommodate specialty cartridges such as Dye Sublimation, Fluorescent, Clear, Gold and Silver toner cartridges.

# Cleaning the Dustproof Glass

If white lines appear on prints, clean the dustproof glass.

1. Turn the printer off and unplug the power cable.

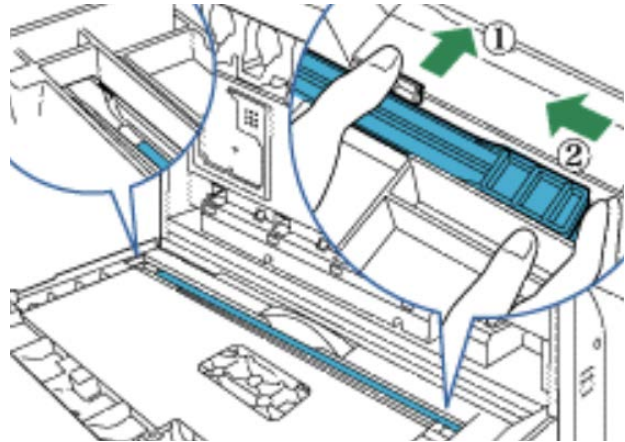
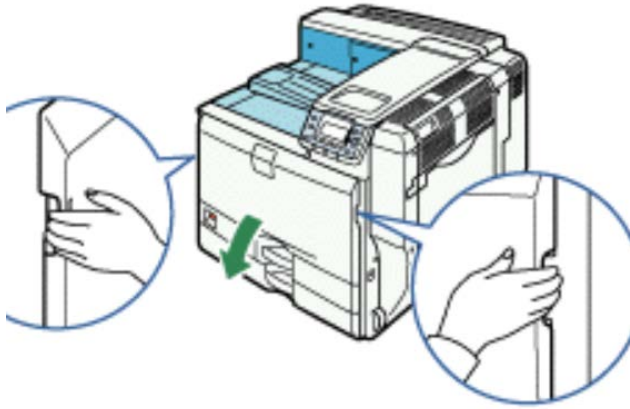

2. Holding the left and right handles, open the front cover.
3. Remove the cleaning stick installed inside the front cover by pushing and holding the grip in the center (1) and then lifting the handle of the cleaning stick (2).

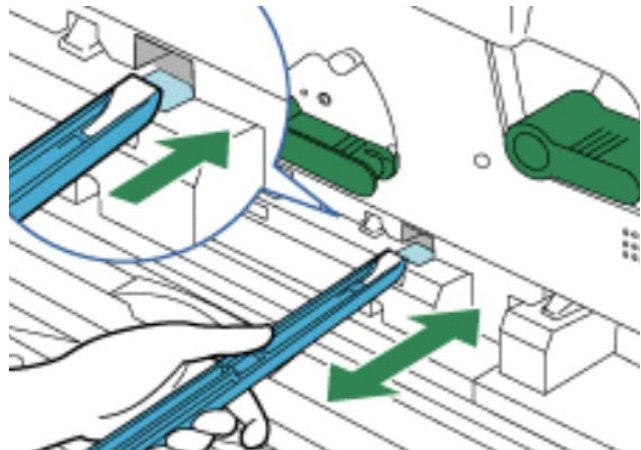
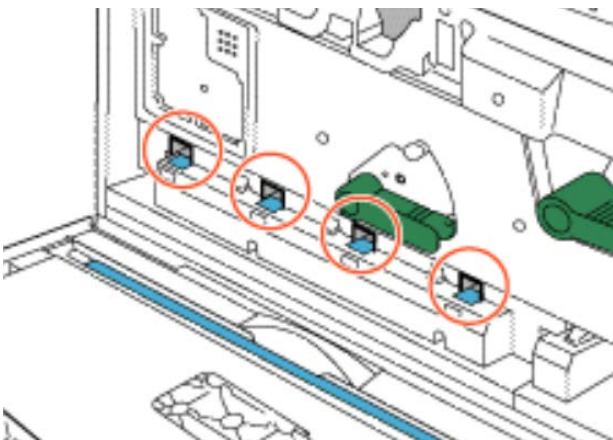

4. Insert and remove the cleaning stick at least three times in each of the 4 holes.

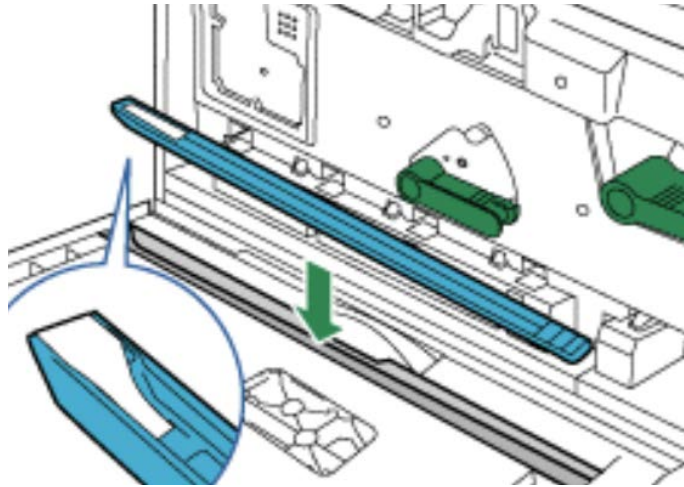

5. When finished, place the cleaning stick back inside the front cover.

## Color Registration Procedure

If the printer registration is out of alignment, run the Color Registration Procedure

- Signs of this would appear as outlines of white or color around your graphic.
1. Using the touch screen on the printer, press User Tools on the home screen.
  2. Select Maintenance > Image > Color Registration.
  3. Press Start to execute the auto Color registration (This take about 30 seconds).
  4. After 'Color Registration is complete' appears, press 'Exit'

# Printing Tips

When transferring images with halftones, it's possible that some of the adhesive from your 2 step paper will not transfer over to the toner during the first step. If you see this happen with your image, just reprint the image with a white overprint using the ProRIP to thicken up the density and give the adhesive something to stick to. Halftone colors use much less toner. Printing the white over the image will fill in the halftones of color, with density below 70%. Using white overprint is necessary, even when transferring to white colored textiles.

There are many variables that could produce different results. Specific steps may need to be altered based on:

- Type and brand of Heat Press: The temperature and duration varies slightly based on the heat press being used. All instructions are based on using a Hotronix Fusion press. Clam shell and other types of swing away presses may also yield different results.
- Type of image: Photos or full color graphics may require a longer press time than vector images or text.
- Type of garment or substrate: Cotton, Polyester, and Spandex material all respond differently to heat, as do hard surfaces like acrylic or wood. All textile instructions are based on cotton garments.
- Toner Coverage: Halftones in image may cause undesired results. Toner coverage should not be less than 70%, otherwise there will be issues with transferring the adhesive to the transfer sheet. Halftones can be corrected by printing white on top of color using the IColor™ ProRIP Software to apply a white layer in one pass. This will help with toner coverage and proper adherence to the garment.

Consult the IColor™ knowledge base for specific instructions on a variety of transfer paper offered at:

<http://www.icolorprint.com/support>

(Or scan this QR Code)



Technical Support Email: Log a ticket at <https://www.icolorprint.com/get-support>

Technical Support Phone: 631-590-1040, Option 2

SAVE THE BOX AND PACKAGING! Needed if the machine needs to be sent back for service.



## ALSO AVAILABLE:

- IColor™ Premium 2 Step Transfer Paper for light and dark colored garments
- IColor™ Select and Select Ultra Bright 2 Step Transfer Paper for light and dark colored garments
- IColor™ Standard 2 Step Transfer Paper for light and dark colored garments
- IColor™ Glitter Adhesive 2 Step Transfer Paper (for use with IColor™ Standard 2 Step Transfer Paper)
- IColor™ Light 1-Step Transfer Paper for light colored garments
- IColor™ Presto 2 Step Transfer Paper for textiles and hard surfaces
- IColor™ Temporary Tattoo 2 Step and Easy Tattoo Transfer Paper
- IColor™ Classic, Premium, Wood and Leather and Ceramic Hard Surface 1-Step Transfer Paper
- IColor™ AquaClear 1-Step Transfer Paper for candles and other substrates not resistant to heat
- IColor™ Label / Sticker Paper (Clear and White) in Letter and Tabloid size
- IColor™ Window Cling Media (Clear and White) in Banner and cut sheet options
- IColor™ Banner Paper
- IColor™ Magnetic Media in Letter and Tabloid size

...and more! Contact your dealer for more information.

## IColor™ Transfer Paper Comparison Charts

### ICOLOR TEXTILE TRANSFER PAPER

ATTRIBUTE	PREMIUM	PREMIUM STRETCH	STANDARD	SELECT UB	SELECT	PRESTO	LIGHT	SPEEDTRANS LIGHT
PROCESS	2 Step	2 Step	2 Step	2 Step	2 Step	2 Step	1 Step	1 Step
DURABILITY (# of Washes @ 104 °F/40 °C)	Up to 100	Up to 100	50+	50+	50+	50+	15+	15+
DARK TEXTILES (BRILLANCE)	BEST	BEST	BETTER	BEST	GOOD	BETTER	FAIR	FAIR
DELICATE TEXTILES	BEST	BEST	GOOD	GOOD	GOOD	GOOD	NOT RECOMMENDED	NOT RECOMMENDED
STRETCHABILITY	BETTER	BEST	GOOD	BEST	BEST	GOOD	GOOD	GOOD
FINISH	MATTE	MATTE	SEMI GLOSS	MATTE	MATTE	SEMI GLOSS	SATIN	SATIN
TRANSFER 'A' SHEET CHARACTERISTIC	OPAQUE	OPAQUE	TRANSPARENT	TRANSPARENT **	TRANSPARENT	OPAQUE	OPAQUE	OPAQUE
PRESS TEMPERATURE (°F/°C)	250°F / 120°C	285°F / 140°C	310°F / 154°C	310°F / 154°C	310°F / 154°C	285°F / 140°C	390°F / 200°C	375°F / 190°C
PRESS TIME	30 + 30 secs	45 + 10 secs	120 + 30 secs	120 + 25 secs	120 + 25 secs	120 + 30 secs	15 secs	10 secs
SOFT HAND	BEST	BEST	GOOD	GOOD	GOOD	GOOD	BETTER	BETTER
COST	\$\$\$	\$\$\$	\$\$	\$\$	\$\$	\$\$	\$	\$

\* Select 800 Ultra Bright has an opaque 'A' sheet

### ICOLOR HARD SURFACE TRANSFER PAPER

ATTRIBUTE	PREMIUM	CLASSIC	CERAMICS	WOOD/LEATHER	PRESTO! HARD SURFACE	PRESTO! PAPER/WOOD	AQUACLEAR	TATTOO
PROCESS	1 Step	1 Step	1 Step	1 Step	1 Step	1 Step	1 Step	2 Step
DURABILITY (RESISTANT TO SCRATCHING/CHIPPING)	BEST	BEST	BEST	BEST	BEST	BEST	GOOD	BETTER
COLOR BRILLIANCE	BETTER	BETTER	BETTER	BETTER	BEST	BEST	BETTER	BETTER
METALLIC FINISH	NO	NO	NO	NO	YES	YES	NO	NO
PRESS TEMPERATURE (°F/°C)	300°F / 150°C *	300°F / 150°C *	300°F / 150°C *	300°F / 150°C *	320°F / 160°C *	265°F / 130°C *	N/A	265°F / 130°C
PRESS TIME	60 SECS *	60 SECS *	180 SECS *	60 SECS *	180 SECS *	90 SECS *	N/A	40 SECS
ACRYLIC	YES	YES	YES	YES	YES	NO	YES	YES
METAL	YES	YES	NO	NO	YES	NO	YES	YES
CERAMIC	YES	YES	YES	NO	YES	NO	YES	YES
TILE	YES	YES	YES	NO	YES	NO	YES	YES
GLASS	YES	YES	YES	YES	YES	NO	YES	YES
CRYSTAL	YES	YES	YES	YES	YES	NO	YES	YES
PAPER/WOOD/CARDBOARD	YES	YES	NO	YES	YES	YES	NO	YES
LEATHER	YES	YES	NO	YES	NO	NO	NO	YES
CANDLES	NO	NO	NO	NO	NO	NO	YES	YES
FLESH	NO	NO	NO	NO	NO	NO	NO	YES
COST	\$	\$	\$	\$	\$\$	\$\$	\$\$	\$\$\$

\* Temperature and press time varies based on substrate

# IColor™ 800W System Specifications

**Print Speed:** Print Speed: Up to 45 ppm Color and Monochrome  
(Transfer media setting speeds may vary)

**Processor:** Intel 1.75 GHz

**Duty Cycle:** Up to 75,000 pg/mo.

**Memory:** 2GB RAM

**Resolution:** Up to 1200 x 1200 dpi

**Emulation:** PCL® 6, PCL 5c; PostScript® 3™

**Operating Systems:** Microsoft Windows® 8 / 10 / 11 (x32 & x64)

**Interfaces:** 10/100-TX Ethernet, High Speed USB v2.0, Wifi through front access panel (not for printing)

**Multipurpose Tray:** Standard 100-sheet; handles transfer media, card, mailing label stock and banners

**Paper Cassette:** 2x 550-sheet Legal/Letter/Universal

**Paper Sizes (Min./Max.):** Multipurpose tray handles up to 100 sheets – 3" x 5" to 12.6" x 49.6";

- Tray 1 Paper Cassette – Fixed for Letter (8.5" x 11") (216 x 279 mm), A4, A5
- Tray 2 Paper Cassette - User adjustable up to 12" x 18" including Letter (8.5" x 11"), Legal (8.5" x 14"), Exec (10.5" x 7.25"), Ledger (11" x 17"), A3, A4, A5, A6 Custom Sizes: 3.55" x 5.83" – 12.6" x 18" / SRA3 (90 x 148 mm to 320 x 457 mm)

**Paper Weight:** Standard Trays: 16 – 82 lb. Bond/ 170 lb. Index (60 – 300 g/m<sup>2</sup>)

Bypass Tray: 14 – 82 lb. Bond/ 170 lb. Index (52 – 300 g/m<sup>2</sup>)

**Size: (WxDxH):** 23.1" x 27" x 34" (587 x 685 x 864 mm) (Standard Configuration)

**Toner Cartridge Yield:** All rated at 5% toner coverage

- Standard CMY: 35,000 pages
- Standard White: 25,000 pages
- Starter CMY: 12,500 pages
- Starter White: 10,000 pages

**Weight:** 187 lb. (85 kg)

**Power Consumption (maximum):** 12 amps (120v models) or 8 amps (230v models)

**Power Options:** 120v & 230v models