



## **User Manual for Zamp Solar Pure Sine-Wave Power Inverters**

**ZS-300PS**

**ZS-600PS**

**ZS-1000PS**

**ZS-2000PS**

# Specifications

| Item                                   | ZP-300PS  | ZP-600PS     | ZP-1000PS   | ZP-2000PS    |
|--|---|--------------|---|--------------|
| Continuous output frequency            | 300W  | 600W         | 1000W   | 2000W        |
| Surge power                            | 600W  | 1200W        | 2000W   | 4000W        |
| Input voltage range (12V)              | 10~15VDC  |              |   |              |
| Input under voltage activation (12V)   | 10.6VDC   |              |   |              |
| Input under voltage protection (12V)   | 10VDC   |              |   |              |
| Input over voltage protection (12V)    | 15VDC   |              |   |              |
| Input voltage                          | 12V   |              |   |              |
| Output voltage                         | 120V AC±10%   |              |   |              |
| Output frequency                       | 60Hz ±1Hz   |              |   |              |
| Output waveform                        | Pure sine wave ( THD≤ 3%)   |              |   |              |
| Conversion efficiency                  | 90%   |              |   |              |
| Overload protection                    | Yes   |              |   |              |
| Thermal protection                     | 65℃±5℃  |              |   |              |
| Use of advanced microprocessor control | Yes   |              |   |              |
| USB Output                             | 5 VDC, Max 1A (Max 2A only for model ZP-2000PS)   |              |   |              |
| Display                                | LED indicator   |              |   |              |
| Length of the remote controller wire   | 15 ft. (4.6m) only for model ZP-1000PS & ZP-2000PS  |              |   |              |
| Intelligent cooling                    | The fan starts to work when the load power is larger than 100W, does not work when no load or small load. |              | The cooling fan on the product will not run when start up the inverter, it will start running only when the case temperature reaches about 40℃. |              |
| Fuse(outer car fuse)                   | 40A   | 40Ax2        | 40Ax4   | 40Ax8        |
| Dimension(LxWxH)                       | 187x95x55mm   | 213x140x74mm | 293x140x74mm  | 435x236x95mm |
| Weight                                 | 0.69Kg  | 1.67Kg       | 2.42Kg  | 5.15Kg       |
| Working temperature                    | 0℃~40℃  |              |   |              |
| Storage temperature                    | -10℃~45℃  |              |   |              |

## 1. BRIEF:

Our power inverter is an advanced tool of power conversion, and it can supply you with AC power converted from DC power source. Not only can be used in cars, vessels and camping, but also can be used in emergency when power fail.

In order to use the inverter efficiently and safely, please install and use it in a proper way. Please read the instruction carefully before installing and using the appliance. read the instruction carefully before installing and using the appliance.

## 2. WARNING AND SAFETY

- 1) Read the manual before use and keep it for future reference.
- 2) Don't put the inverter under sunshine, nearby heating source, drench or humidity environment
- 3) The case housing of inverter will be calorific when using, please avoid touching the material that can't stand of high temperature, such as clothes, sleeping bag and carpet.
- 4) Our power inverter is designed to use with the negative ground electrical system! Don't use with positive ground electrical systems (The majority of modern automobiles, RVs, trucks and boats are negative ground).
- 5) Do not disassemble the unit random, it may cause fire or electric shock.
- 6) Keep inverter away from children and don't allow them to play with the unit.
- 7) The power inverter will output AC power as utility power, please treat the output terminal as carefully as your home AC socket. Don't put any other things into the output terminal except electrical appliance plug. It will bring danger or fire if using in a wrong way.
- 8) Disconnect the battery and inverter when no use.

## 3. PARTS LIST

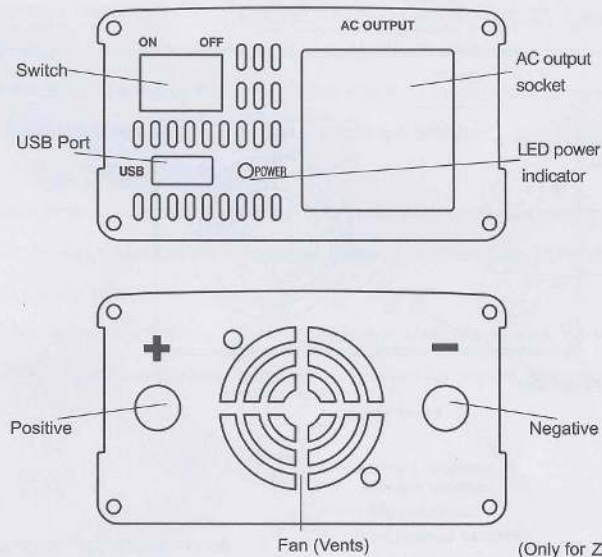



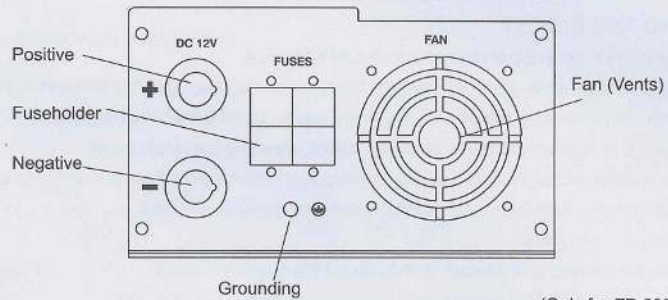
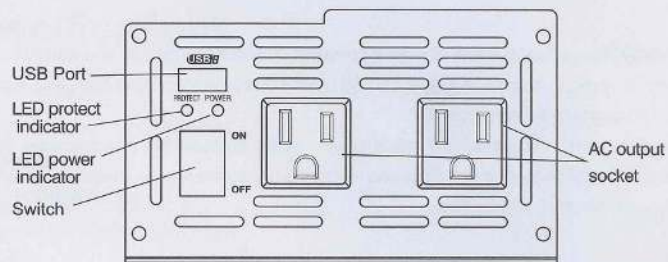

(Only for ZP-600PS)

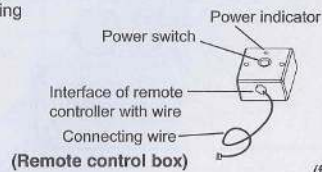
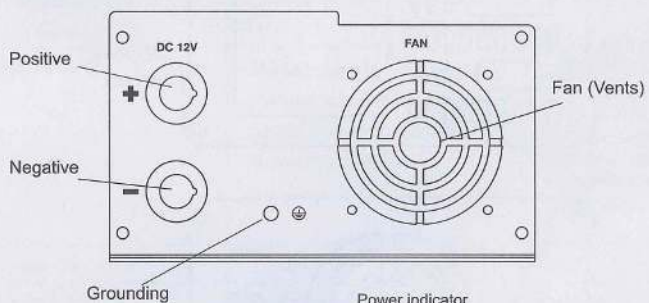
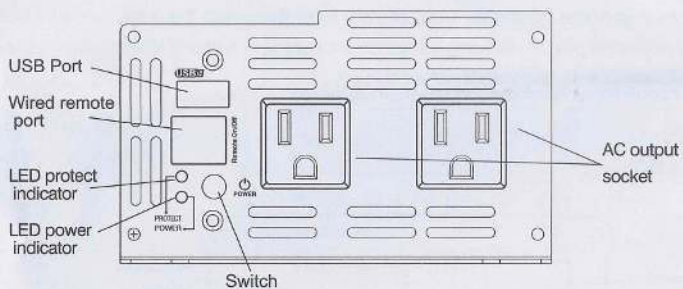

(Remote control box)

(for ZP-1000PS & ZP-2000PS)

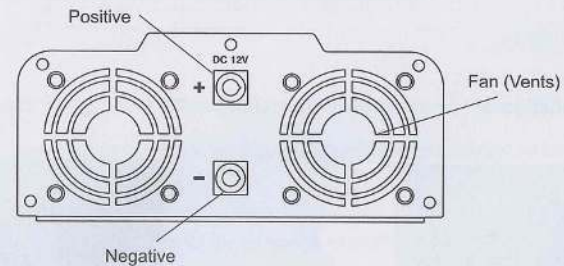
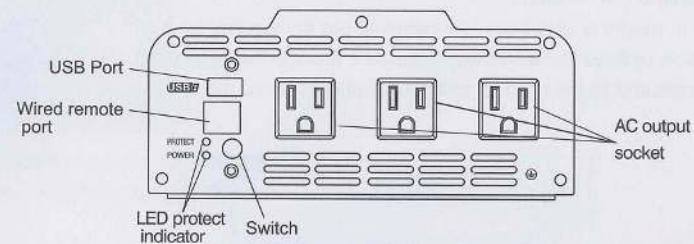

#### 4. INSTALLATION

##### 1. The requirements of the installation location.

Ensure there is enough space for the installation, and the location should according to the following requirements:

- 1) Dryness: never drop water or other liquids on the inverter
- 2) Coolness: the ambient temperature should be 0~40°C, and the perfect temperature is 10-25°C. The lower the better in this range of the ambient temperature.
- 3) Ventilation: there should be a certain distance between the unit and the surrounding appliance, do not obstruct the vents
- 4) Cleanness: do not install the unit in the place with dusty, timbering residue or particle which may be brought into the product when the cooling fan works and may influence the normal operation
5. There will be some electrical arcing or spark when the inverter connects with the battery, so the combustible materials should not be around, such as gasoline, alcohol etc.

## 2. Installation of inverter

Since the weight is very heavy, it's better to put the inverter on a stable space, such as floor, table or fixed kickstand etc. Make sure that the kickstand can bear the weight of the inverter, and fix the product with four screws, to avoid dropping.

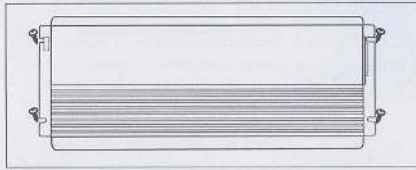

## 3. Installation of remote control box (Only for ZP-1000PS & ZP-2000PS)

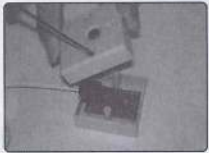

1) Open the cover of remote control box.



2) Fix the bottom of the remote control box on suitable place, such as wall, tabletop etc.



3) Close the cover of remote control box



4) If simply fixed to a vertical plane, firstly fix two screws in the position of 40mm apart on the plane, then hung up the remote control box on it.

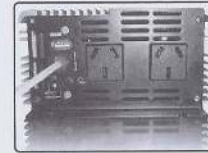

5) Connect the cable between the remote control box and inverter.

**Indication:** This product can be used as normal pure sine wave inverters even not connect to the remote control box

## 5. USAGE

### 1. How to use inverter

1. Check the output voltage and capacity of the battery, it should comply with the requirement of the product use.
2. Connect the battery and the DC cable of the inverter, ensure that the polarities can not be reversed and in good contact.
3. Turn on the switch, the green LED power indicator is on
4. Turn off electrical appliances and insert electrical appliance plug to the AC output socket of inverter. Turn on electrical appliance for using.
5. After finish, turn off electrical appliance and inverter, disconnect inverter with battery if not use for long time.

### 2. How to use inverter (Only for ZP-1000PS & ZP-2000PS)

1. Check the output voltage and capacity of the battery, it should comply with the requirement of the product use.
2. Connect the battery and the DC cable of the inverter, ensure that the polarities can not be reversed and in good contact.
3. Long press the power switch on the inverter or the remote control box for more than 0.5 seconds then release, the power indicator on the inverter and remote control box are on, the inverter start to work. (Open the inverter by this way can effectively avoid Interference or mistakenly boot)
4. Turn off electrical appliances and insert electrical appliance plug to the AC output socket of inverter. Turn on electrical appliance for using.



5. The cooling fan on the product will not run when start up the inverter, it will start running only when the case temperature reaches about 40 °C.

6) When not in use, press the power switch on the inverter or remote control box, the power indicator is off, means the inverter has shut down. Inverter will not consume the battery current in shutdown state.

### 3. How to use USB power supply

This model with USB output, can provide stable 5V DC voltage, the maximum current is 1000mA (ZP-2000PS maximum current is 2000mA), can directly provide power for the portable device with USB port.

**Notice:** Before use the USB power supply, please make sure the device can be charged by USB and the maximum working current is no more than 1000mA (ZP-2000PS the maximum working current is no more than 2000mA).

### 6. BATTERY OPERATING TIME

Battery operating time depends on battery capacity (AH) and load power (W), the calculation formula of operating time is: battery capacity (AH) x battery output voltage (V) ÷ load power (W)

For example: battery specification: 12V 200Ah, load power is 600W, then the operating time is :  $200 \times 12 \div 300 \approx 8$  hours

### 7. SOFT START TECHNOLOGY

The unit has the latest soft start technology, that is, the output voltage gradually increases to the normal value from low value after turn on the inverter. It can reduce the transient large current attack and help to start the hard start load

For large power inductive load, such as electrical motor or capacitive loads such as Large Power SMPS adopt soft start. Please turn on the switch of load, then turn on the switch of inverter.

### 8. OUTPUT VOLTAGE & WAVEFORM

The output waveform of the inverter is pure sine wave, which has the same waveform of the sine utility power, even higher than the purity of the domestic power. This kind of waveform is suitable for most electrical appliances, including linear and switching in electronic equipments, transformers, motor etc. Compare with modified sine wave inverters, the power factor and power utilization of electric fans, refrigerators and other inductive loads can be improved by using pure sine wave inverter, and the noise during appliance operating can be effectively reduced too.

Pure Sine Wave Output  
(120 VAC Model)

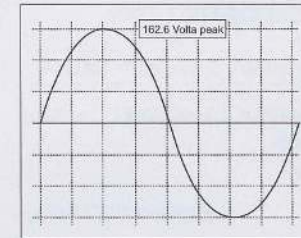

### 9. FUNCTION

**1. Input under-voltage alarm:** When the input DC voltage is lower than 10.6V, the buzzer will whistle intermittently to remind that the inverter will go into the under voltage protection. Pay attention to save the data if you are using computer.

**2. Under voltage protection:** The inverter will automatically shut down when the input DC voltage is lower than 10V. The buzzer will whistle continuously and the green light is off, red light is on. Please turn off the inverter and use it after recharge the battery.

**3. Over voltage protection:** The inverter will automatically shut down when the input DC voltage is higher than 15V. The buzzer will whistle continuously and the switch indicator light is on. Please turn off the inverter and adjust the input voltage to the admissible range.

**4. Overload protection:** The inverter will automatically shut down when the load power is higher than the rated power. The buzzer will whistle continuously. Turn off the inverter and resume to normal operation after taking away the redundant load.

**5. Thermal protection:** The unit will be calorific during operation. If the temperature is higher than 65°C, the inverter will automatically shut down. Then the buzzer will whistle continuously and the green light is off, red light is on. Please turn off the inverter, and continue using it after the temperature goes back to normal temperature naturally. Meanwhile find out the factors caused the fault, such as ventilation, ambient temperature, vent, load power and so on. It can avoid the similar things happen after check it.

## 10. TROUBLESHOOTING TIPS

| Fault/Display                                 | Cause   | Solutions   |
|---|---|---|
| No output voltage, buzzer sounds continuously | Low input DC voltage  | Recharge or replace the battery   |
|   | High input DC voltage   | Do not use it when the battery is charging. Check the rated voltage of the battery and make sure that it is in the allowable range of the input voltage   |
|   | Overload  | Reduce the load power.  |
|   | Over temperature  | Cut off the load and keep it cool naturally for 10 to 30 minutes. Restart it after it resume to normal temperature. The load power is too large and reduce the total load power to the range of rated power. Avoid blocking the vent and improve the ventilation condition. Reduce the ambient temperature. |
| No output voltage                             | 1. The switch is off.<br>2. The battery lead doesn't connect well   | 1. Turn on the power switch.<br>2. Check the joint and make sure it's well connected.   |
| Incorrect output voltage                      | 1. RMS Multimeter measurement error<br>2. The battery power of RMS Multimeter is low<br>The input voltage is too high or too low                            | 1. Use the true RMS multimeter to measure, such as the model FLUKE 177/179.<br>2. Try to maintain the input voltage in the range of rated power<br>3. Change the battery of the multimeter then test again.   |
| Cannot drive the load                         | 1. Load power is too large, or the actual power of the appliance exceeds nominal power.<br>2. The starting power is larger than rated power (such as motor) | 1. Reduce the load power, or open the appliance first, then open the inverter, The inverter internal soft-start circuit to buffer start the appliances.   |

| Fault/Display  | Cause       | Solutions  |
|--|-------------|--|
| When using with TV or audio, There snowflake on the screen or noise of the audio | Disturbance | 1. Separate the inverter and antenna.<br>2. Use screened antenna |

If inverter still cannot work normally after solutions mentioned above are tried, please return inverter to supplier for repairing. The internal parts may be damaged.

## 11. WARRANTY

We take the guarantee of one year from the purchasing day. During the guarantee period, any malfunction caused by our product quality, our company will fix the unit for free. But any one of the following conditions is beyond our guarantee terms.

1. The box distorted, damaged or changed, and interior parts damaged because of the exterior hit or drop.
2. Connect the DC power adversely.
3. Dismantled or repaired the unit by un-granted person.
4. The unit was damaged by incorrect installation or operating method.