



JUMBO MAINS BATTERY SERIES (JMB) USER MANUAL

(JMBx-ZM1, JMBx-ZM2, JMBx-ZM50)



1 CONTENTS

| | | |
|----------|---|-----------|
| 1 | INTRODUCTION | 5 |
| 2 | IMPORTANT NOTES | 8 |
| 2.1 | ELECTRIC FENCES | 8 |
| 2.2 | ENERGIZERS | 8 |
| 2.3 | POWER SUPPLY OPTIONS | 8 |
| 2.4 | MOUNTING | 9 |
| 2.5 | LIMITATIONS | 9 |
| 3 | FEATURES | 10 |
| 3.1 | MODEL SPECIFIC FEATURES | 11 |
| 3.1.1 | JMBx-ZM1 | 11 |
| 3.1.2 | JMBx-ZM2 | 12 |
| 3.1.3 | JMBx-ZM50 | 13 |
| 4 | SPECIFICATIONS | 14 |
| 5 | EQUIPMENT REQUIREMENTS AND OPTIONS | 15 |
| 5.1 | REQUIREMENTS | 15 |
| 5.2 | OPTIONS | 15 |
| 6 | DESCRIPTION | 16 |
| 6.1 | INDICATOR LEDs | 16 |
| 6.2 | ARMING SWITCH | 17 |
| 6.3 | VIRTUAL KEYPAD | 18 |
| 6.4 | INTERNAL BEEPER/KEYPAD BEEPER | 18 |
| 6.5 | CONTROL INPUTS (IN1, IN2, IN3) | 18 |
| 6.6 | LIGHTNING PROTECTION | 19 |
| 7 | OPERATION (HOW TO CONTROL) | 19 |
| 7.1 | CONTROL ARBITRATION | 20 |
| 7.2 | CONTROL INPUTS | 20 |
| 7.3 | PC CONTROL | 20 |
| 7.4 | CLOUD CONTROL | 20 |
| 7.5 | KEYPAD | 20 |
| 7.6 | VIRTUAL KEYPAD | 21 |

| | | |
|-----------|--|-----------|
| 8 | VIRTUAL KEYPAD | 21 |
| 8.1 | CONNECTING YOUR PHONE TO THE ENERGIZER | 21 |
| 8.2 | CONFIGURATION PAGE (OPTION PROGRAMMING) | 23 |
| 8.3 | SECTOR PRGRAMMING GUIDE. | 24 |
| 8.3.1 | SAVING SECTOR DETAILS TO MODULE | 25 |
| 8.3.2 | SAVING SECTOR DETAILS TO DEVICE | 25 |
| 8.4 | CONTROL AND MONITOR PAGE | 26 |
| 8.4.1 | ARM AND DISARM | 26 |
| 8.4.2 | MUTING | 26 |
| 8.4.3 | CLEAR | 26 |
| 9 | INSTALLATION. | 27 |
| 9.1 | INSTALLATION STEPS | 27 |
| 9.2 | CONFIGURATION JUMPERS | 28 |
| 10 | FENCE WIRING DIAGRAMS. | 29 |
| 10.1 | JMBX-ZM1 | 29 |
| 10.1.1 | MONITORING FROM THE START OF THE FENCE | 29 |
| 10.1.2 | MONITORING FROM THE START AND END OF THE FENCE | 29 |
| 10.2 | JMBX-ZM2 | 30 |
| 10.2.1 | MONITORING FROM THE START OF THE FENCE | 30 |
| 10.2.2 | MONITORING FROM THE START AND END OF THE FENCE | 30 |
| 10.3 | JMBX-ZM50. | 31 |
| 10.3.1 | MONITORING 50 SECTORS ON A FENCE | 31 |
| 10.3.2 | WIRING A SECTORIZED FENCE | 31 |
| 10.3.3 | SECTOR DIVIDER | 33 |
| 10.4 | LOW VOLTAGE TERMINALS | 33 |
| 10.5 | LOW VOLTAGE WIRING DIAGRAMS | 35 |
| 10.5.1 | MAINS. | 35 |
| 10.5.2 | MAINS AND RECHARGEABLE BATTERY. | 35 |
| 10.5.3 | SOLAR POWERED | 35 |
| 10.5.4 | INPUTS | 36 |
| 10.5.5 | KEYPAD | 37 |
| 10.5.6 | PERIMETER PATROL | 37 |
| 10.5.7 | CLOUD ROUTER. | 38 |
| 10.5.8 | SURGE PROTECTION | 38 |

| | |
|---|-----------|
| 11 CONFIGURATION OPTIONS IN DETAIL | 39 |
| 11.1 GROUP ID | 39 |
| 11.2 HIGH POWER MODE POWER LEVEL (ZONE 1) | 39 |
| 11.3 HIGH POWER MODE POWER LEVEL (ZONE 2) | 39 |
| 11.4 BATTERY CHARGER FLOAT VOLTAGE | 40 |
| 11.5 BATTERY ALARM VOLTAGE | 40 |
| 11.6 RF REMOTE ID | 40 |
| 11.7 PULSE TIME | 41 |
| 11.8 FENCE CUT ALARM | 41 |
| 11.9 FENCE VOLTAGE ALARM LEVEL (ZONE 1) | 41 |
| 11.10 FENCE VOLTAGE ALARM LEVEL (ZONE 2) | 42 |
| 11.11 CURRENT ALARM LEVEL (ZONE 1) | 42 |
| 11.12 CURRENT ALARM LEVEL (ZONE 2) | 43 |
| 11.13 GROUND VOLTAGE ALARM LEVEL | 43 |
| 11.14 FENCE ALARM DELAY (PULSE COUNT) | 43 |
| 11.15 ANTI-BRIDGING | 44 |
| 11.16 DFD™ | 45 |
| 11.17 SECTORS | 45 |
| 11.18 INPUT PROGRAMMING | 45 |
| 11.19 INPUT FUNCTIONS | 46 |
| 11.20 INPUT TYPE | 47 |
| 11.21 GATE DELAY | 47 |
| 11.22 ENTRY DELAY | 48 |
| 11.23 EXIT DELAY | 48 |
| 11.24 SIREN ON TIME | 48 |
| 11.25 SIREN OFF TIME | 49 |
| 11.26 SIREN CYCLES | 49 |
| 11.27 AUTO REARM TIME | 49 |
| 11.28 RELAY PROGRAMMING | 50 |
| 11.29 RELAY FUNCTIONS | 50 |
| 11.30 PROGRAMMING WITH THE VIRTUAL KEYPAD | 53 |
| 12 SECTOR PROGRAMMING METHOD - LOOP MONITOR (JMBX-ZM50 ONLY) | 56 |
| 12.1 USING THE VIRTUAL KEYPAD | 56 |
| 12.2 SITE SECTOR RECORD | 61 |
| 13 WARRANTY | 63 |

1 INTRODUCTION

Congratulations on your choice of a JVA Energizer. In choosing to purchase a JVA product you have opted for the highest quality in electric fencing. Please read this manual entirely before installing or operating your new energizer.

To ensure your eligibility for the warranty program offered with this device, please retain your proof of purchase. For a warranty description, please see the final page of the manual.



There are high voltages inside the JMB energizers.

The high voltage inside the energizer may take a long time to discharge.

Wait at least 10 minutes after turning off before opening the case.

Before working on the high voltage wiring of an electric fence, it is recommended that the energizer is disarmed, and a short circuit is placed from the fence live wires to earth. This is a sensible precaution against the energizer being armed by others, while you are working on the fence.

The JMB series is the most powerful and feature rich electric fence energizer JVA has manufactured to date. This continues JVA's push for technical superiority in the area of Monitored Electric Fencing and IP Energizers®.

While the JMB was specifically designed for game parks and exclusion fencing, they are also well suited to any large permanent electric fencing application. The highest powered JMB series produces a stunning 46J of stored energy. The JMB series consists of six models:

| Model | Description |
|------------|---|
| JMB32-ZM50 | 46J IP Energizer® with 50 Sector Loop Monitoring |
| JMB32-ZM1 | 46J IP Energizer® with Power Monitoring |
| JMB32-ZM2 | Dual Zone 46J IP Energizer® (2 x 23J) with Power Monitoring |
| JMB25-ZM50 | 36J IP Energizer® with 50 Sector Loop Monitoring |
| JMB25-ZM1 | 36J IP Energizer® with Power Monitoring |
| JMB25-ZM2 | Dual Zone 36J IP Energizer® (2 x 18J) with Power Monitoring |

Table 1 - Model Descriptions

A monitored electric fence reduces maintenance by reporting whenever there is a fault and by allowing you to check the fence from wherever you are using the Internet.

The JMB series introduces the JVA Virtual Keypad. This allows you to monitor, control and program the energizer from your Wi-Fi enabled smart device (Phone, Tablet or Laptop). The JMB's may also be controlled and monitored with a wired Keypad.

The JMB series introduces the JVA Virtual Keypad. This allows you to monitor, control and program the energizer from your Wi-Fi enabled smart device (Phone, Tablet or Laptop). The JMB's may also be controlled and monitored with a wired Keypad.

By incorporating Power Monitoring and our Patented Distant Fault Detection (DFD™) technology, the JMBx-ZM1 and JMBx-ZM2 models can be configured to monitor long fences without the need to create loops or install a return wire to bring the end of fence voltage back to the energizer. This is also known as "Start of Fence" monitoring.

If you want to use traditional “End of Fence” monitoring these models also have an optional fence return terminal.

The JMBx-ZM50 contains a Loop Monitor. This means it can power a fence from both ends in a loop of one or more live wires around a property. By doing this it can determine and report the position of a fault to within one sector in fifty. Previously loop monitors had a range limitation of approximately 10km of fence or 30km of wire. By incorporating DFD™, the JMBx-ZM50 has greatly increased this range ^{Note1}.

All JMB models also contain a Ground (Earth) monitor which can be configured to create an alert if the earth system is insufficient. They are also Remote Ready and can be controlled using a JVA remote control.

The JMB's are designed to meet or exceed the requirements of IEC60335.2.76.

Note 1: While this feature has been designed and tested in the lab, insufficient field testing has been done to find the new limitations.

2 IMPORTANT NOTES

2.1 ELECTRIC FENCES

1. Electric fences are not toys; do not let children play with them.
2. Electric fences should only be installed with regard to the relevant standards and work place health and safety requirements.
3. Electric fences must have an 'earth'. An electric fence earth or ground is one or more pieces of metal (e.g. earth rods) driven into the earth.

2.2 ENERGIZERS

1. The energizer places a very fast, very high voltage pulse on the fence live wires approximately once every second. The fence is 'safe' in that the pulse is too short to cause electrocution. Please be advised that there is always a risk associated with any device designed to impart an electric shock. Do not allow children or elderly persons to touch the energizer or fence live wires.
2. The maximum length of fence able to be energized depends on many factors, for example the earth resistance, number and spacing of wires on the fence, type/quality of insulators, resistance of wire etc. The amount of grass or bushes touching the wires also alters the performance. Fence circuit layout is very important. Another factor to consider is acceptable fence voltage, for some stock situations this is 3kV, others may require more, or less. Therefore the rated kilometres (distance) of fence that the energizer will power effectively is a guide only.

2.3 POWER SUPPLY OPTIONS

1. The JMB electric fence energizers can be powered from a number of power sources.
 - a. 12V external rechargeable battery (not supplied)
 - b. 12V external battery with solar panel (not supplied)
 - c. Mains via 24V plug pack (optional)

2.4 MOUNTING

- Always ensure adequate ventilation is given to the external 12V battery. Lead Acid batteries may emit explosive gases while charging!
- Always mount the power supply either indoors or undercover.

2.5 LIMITATIONS

At the time of writing this manual the following were the known limitations or features that are yet to be added.

- The JMB series requires an external Gateway to connect to the Cloud Router.
- The IP Energiser controller App is not supported yet.
- The JVA fence line remote control is not yet available.

3 FEATURES

Combined electric fence energizer and monitor

- Power or Loop monitor depending on model
- Virtual Keypad via your Wi-Fi enabled device (smart phone, laptop etc.)
- Distant Fault Detection (DFD™) technology
- High powered (up to 46 Joules stored)
- Mains or 12V Battery powered (mains via optional 24V plug pack)
- Lightning protection on all fence connections
- No mains inverter required to run on solar and battery
- Power on demand meaning it only uses the power it needs for the fence conditions
- Able to be controlled and/or monitored through multiple options:
 - o Virtual Keypad using on board Wi-Fi
 - o Cloud Router (requires a Cloud Router account and Gateway)
 - o Perimeter Patrol (requires a PC, TCP/IP interface and Perimeter Patrol Licence)
 - o Most JVA Z series keypads (4 Line or Touch screen keypad)
 - o Fence line Remote Control¹
- Inbuilt 1A backup battery charger
- 1 Siren and 2 Strobe 12V outputs for standalone security installations (switched 12V DC)
- ON/OFF switch

Proudly design and manufactured in Australia

¹ Works with the soon to be released JVA Fence Line Remote Control. May also be compatible with other manufacturer's Remote Control / Fault Finders.

If a non JVA remote control is used on a ZM2 it will turn both fences on or off.

3.1 MODEL SPECIFIC FEATURES

3.1.1 JMBx-ZM1

The JMBx-ZM1 contains our patented power monitor with Distant Fault Detection (DFD™). The Power monitor measures both the real and reactive components of the fence feed current. By doing so, it can detect a fault at distances beyond 10km from the Energizer.

- Up to 46 Joules (stored) for better performance on long fences
- Measures Feed, Return and the Ground voltage
- Measures real and reactive Feed currents to distinguish real faults from capacitive fence currents

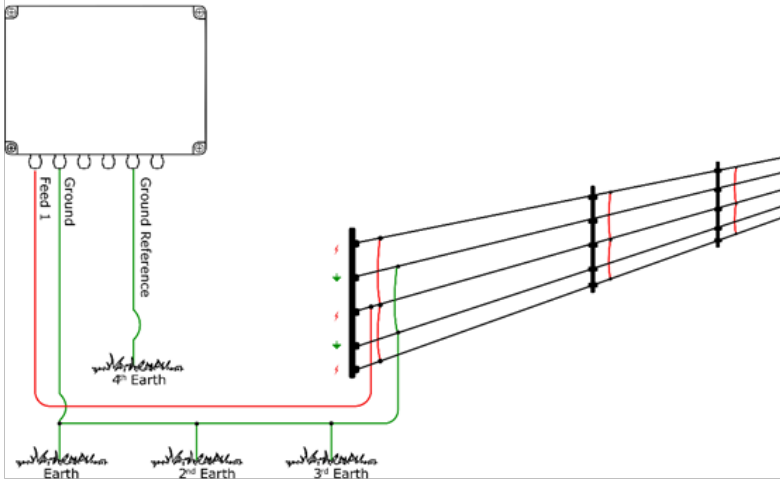

Figure 1 - Typical JMBx-ZM1 setup

3.1.2 JMBx-ZM2

The JMBx-ZM2 contains our patented power monitoring with Distant Fault Detection (DFD™). The Power monitor measures both the real and reactive components of the fence feed current. By doing so, it can detect a fault at distances beyond 10km from the energizer. The JMBx-ZM2 contains circuitry that allows it to power two separate fences. Each fence has its own Power monitor and optional fence return terminal for end of fence voltage monitoring.

- Two independent fence zones each with up to 23 Joules (stored)
- Synchronised outputs can be bridged for up to 46J (stored) into one fence
- Measures both zones Feed and Return and the Ground voltage
- Measures real and reactive Feed currents to distinguish real faults from capacitive fence currents

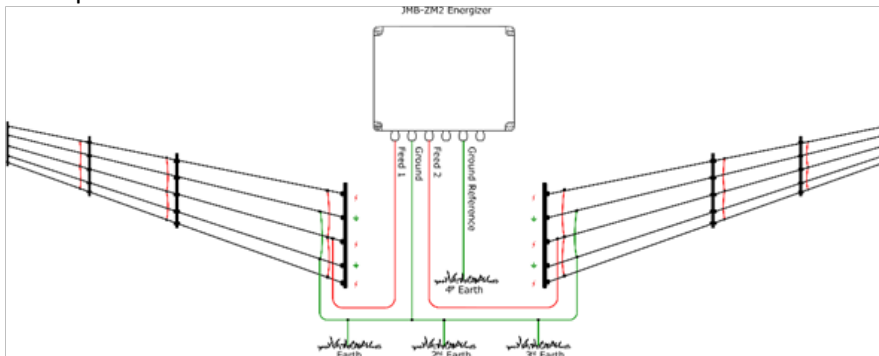

Figure 2 - Typical JMBx-ZM2 setup

3.1.3 JMBx-ZM50

The JMBx-ZM50 contains our patented loop monitor with Distant Fault Detection (DFD™). The loop, or loops, of live wires may run down and back on the same fence or all the way around a property.

While previous fence loop monitors suffered from a range limitation of approximately 10km of fence or 30km of wire, DFD™ has greatly increased this range. JMBx-ZM50 features include:

- Can split a single fence into up to 50 sectors
- Can report the position of a fault as a percentage of overall fence length.
- Short sectors can be accurately defined using JVA sector dividers. See section 9.2.22 on sector dividers.
- ELV open circuit detection.

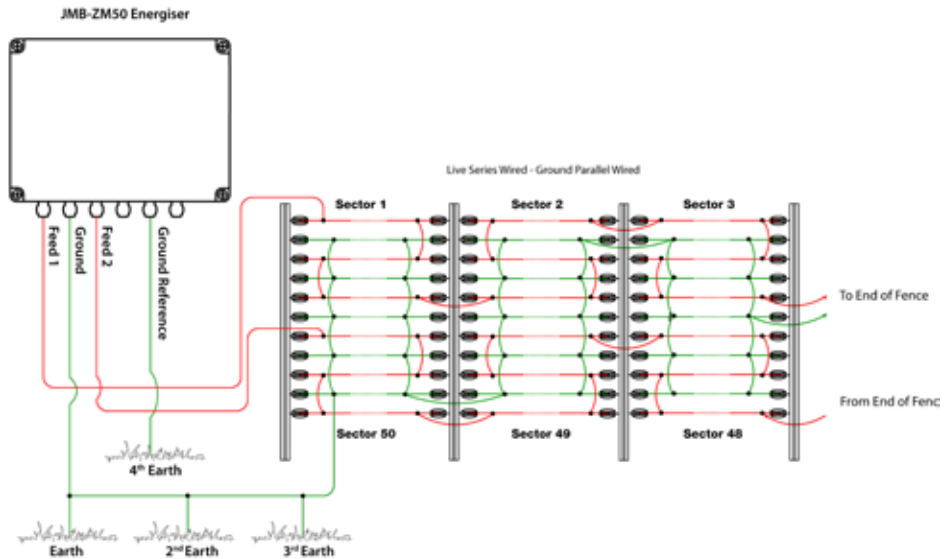

Figure 3: Typical JMBx-ZM50 setup

4 SPECIFICATIONS

| Specification Name | Value |
|---|--|
| Nominal Battery Voltage | 14.3Vdc |
| Power consumption (maximum 46 stored joules) | 3.9A at 13.5Vdc 1.9A at 24Vdc |
| Maximum voltage on control inputs (Note 1) | 12Vdc |
| Maximum power provided to “Siren” and “Strobe” outputs (Note 2) | 35 Watts |
| Minimum Solar panel size (Note 3) | 350W (6 hours sun) |
| Minimum Solar battery capacity | 450 Ah (20% minimum over 4 days without sun) |

Table 2 - Electrical Specifications

Note 1: The control inputs are powered with a weak internal pull up (5 volts at 0.2mA). The inputs are designed to be operated from voltage free contacts (relays or switches) or switched voltage. If the switched voltage method is used, the control voltages must not exceed 12V and a 1000 ohm pull down resistor is required across the input.

Note 2: The rated power is the combined output power of both the “Siren” and “Strobe” outputs. The voltage which can be expected on this output is the battery voltage. The combined maximum output current of both these outputs is 2.5 Amps. Note that the maximum output power will drop as battery voltage drops.

Note 3: Please see our Solar Calculator here <https://www.jva-fence.com.au/solar.php>

5 EQUIPMENT REQUIREMENTS AND OPTIONS

5.1 REQUIREMENTS

- 24V power pack (optional); Or
- 12V external battery with solar panel (not supplied)
- An effective earth connection
- Electric fence, posts, insulators, wire etc.

5.2 OPTIONS

- Wi-Fi enabled device for Virtual Keypad
 - 12V Siren (x1) or Strobe (x2) light
 - 4 Line Keypad or Touch Screen Keypad
 - Cloud Router web application. Requires:
 - a. Computer and/or Smart Phone (internet connection required)
 - b. Wi-Fi Gateway (PTE0253) or Cellular Gateway (PTE0320)
 - c. Cloud Router Subscription, see www.jva-fence.com/cloudrouter
 - Perimeter Patrol PC application.
 - This requires:
 - a. Windows PC (Windows 7 or later)
 - b. PAE223 USB to serial adaptor or a PAE212 TCP/IP adaptor
- For more information on these options please see www.jva-fence.com.au

6 DESCRIPTION

6.1 INDICATOR LEDS

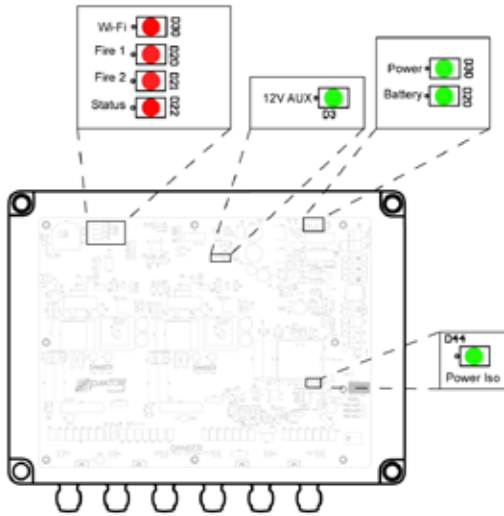

The status LED's on the PCB of the JVA JMB series energizers allow the user to quickly check the status of the unit and if any action needs to be taken.

| Name | LED | Description |
|-----------|-----|--|
| Wi-Fi | D30 | Flashes Wi-Fi status: Once for station mode, twice for Wi-Fi connected |
| Fire 1 | D20 | Flashes when Zone 1 is armed; Long flash if it is in alarm |
| Fire 2 | D21 | Flashes when Zone 2 is armed; Long flash if it is in alarm |
| Status | D22 | Flashes error codes, see table 3 |
| Power | D19 | Shows 24V input power is available (24V is being supplied) |
| Battery | D11 | Shows 12V power is available (Battery is connected) |
| 12V Aux | D3 | 12V Aux power |
| 3V3 | D62 | Shows that there is no issue with the 3.3V rail |
| Iso power | D44 | Shows Isolated processor power is turned on |

Table 3 - LED Status Lights

| Status LED Flashes | Meaning | Corrective Action |
|--------------------|--------------------------|---|
| 1 | Tamper Alarm | Replace the LID, or Fit J12 inhibit tamper |
| 2 | 24Vdc power fail | Restore power, check the main power fuse |
| 3 | Low battery, bad battery | Charge or replace battery, check the battery fuse |
| 4 | PCb service fault | Return to repair/service centre to be checked by a technician |

Table 4 - LED Error Codes

6.2 ARMING SWITCH

When arming or disarming the energizer on you can use the Switch on the side of the enclosure. If you have a JMBx-ZM2 there will be 2 Switches, one controls Zone 1 and the other controls Zone 2.

To turn them on you will need to flick the button so the side with the “1” is pressed down. If the energizer is armed and disarmed using an external control method such as the virtual keypad, the switch is not a reliable indicator of the armed state. External control methods will require the switch to be flicked to take control back.

It is recommended that you use the switch for manual testing.



6.3 VIRTUAL KEYPAD

A Wi-Fi enabled device (such as a smart phone, laptop etc.) can be used to connect to the energizer's onboard Wi-Fi. Once connected, a browser (Chrome) can be opened on the device to visit a webpage that allows monitoring, control and programming of the energizer.



Figure 4 - Virtual Keypad Interface

Note: At this stage the energizer's onboard Wi-Fi cannot connect the energiser to the Internet for Cloud or IP Energiser App control. It is currently for Virtual Keypad operation only.

6.4 INTERNAL BEEPER/KEYPAD BEEPER

A JVA wired keypad can also be used. See the manual for the particular keypad for details. Depending on the settings, the internal beeper and an optional external keypad beeper may sound when there is a fence alarm or a general alarm.

6.5 CONTROL INPUTS (IN1, IN2, IN3)

The JMB has some multipurpose (programmable) Inputs and Outputs. The default function of these inputs is to arm the energiser. See the section on programmable options (configuration) for more detail.

The control inputs are powered with a weak internal pull up (5 volts at 0.2mA). The inputs are designed to be operated from voltage free contacts (relays or switches) or switched voltage. If the switched voltage method is used the control voltages must not exceed 12V and a 1000 ohm pull down resistor is required across the input.

6.6 LIGHTNING PROTECTION

Although the JMB energizers contain internal lightning protection elements, outboard lightning protection systems such as an external lightning diverter is still recommended to further reduce lightning damage and reduce repair costs. Ask your JVA dealer about lightning protection for your fence.

7 OPERATION (HOW TO CONTROL)

The JMB energizers may be armed and disarmed (controlled) using a variety of methods:

Inbuilt:

- The Virtual Keypad
- The Switch(es) on the side of the enclosure
- A fence line Remote Control
- Removing power

Option external methods:

- Switches connected wired into control inputs (IN1, IN2, IN3)
- A Low-level interface (wired to control inputs) from a third-party security alarm panel or Physical Security Information System (PSIM)
- A remote-control radio receiver connected to the control inputs
- A JVA Keypad (4 Line Keypad, Touch Screen Keypad) wired into the Keypad Bus terminals
- A Cloud Router Gateway (Wi-Fi, LAN or Cellular)
- A Windows PC running JVA Perimeter Patrol

Note: More than 1 method may be used in one installation

Danger! If more than one method is used, **you** need to manage the risk of someone else turning the fence on again after you have turned it off.

7.1 CONTROL ARBITRATION

If the JMB is configured with two different ways to control it, then the most recent control method will have control. For example, if the JMB is armed via the Virtual Keypad and then disarmed at the side switch it will disarm. If it was disarmed using the fence line remote, it can be rearmed using a connected Cloud Router gateway.

7.2 CONTROL INPUTS

See section 10.4 Low Voltage Terminals.

7.3 PC CONTROL

A standard Windows PC may be used to control and monitor your JMB energizer(s) as well as other JVA equipment. This requires an adapter from the JMB Keypad bus to the PC via USB or LAN.

Ask your JVA Dealer for a demonstration of Perimeter Patrol™ software or visit our web site.

7.4 CLOUD CONTROL

Any smart phone, Apple or Windows PC may be used to control and monitor your JMB energizer/s as well as other JVA equipment. This requires a Cloud Router gateway connected to the JMB Keypad bus terminal. Wi-Fi, LAN and Cellular gateways are available.

Ask your JVA Dealer for more information on [Cloud Router](#) or visit our Cloud Router web site.

7.5 KEYPAD

A keypad can be wired into the JMB Keypad bus terminals. This can be positioned on a wall inside your house (for example) for easy monitoring and control of the energiser. The JVA 4-Line and Touch Screen Keypads are supported.

These keypads provide an easy to use menu driven user interface.

7.6 VIRTUAL KEYPAD

The virtual keypad is an interface that can be accessed with any Wi-Fi enabled device that can browse to a web page (phone, tablet, laptop, etc).

8 VIRTUAL KEYPAD

8.1 CONNECTING YOUR PHONE TO THE ENERGIZER

The Virtual Keypad can be used to monitor, control or setup the JMB. To do this the inbuilt Wi-Fi module defaults to Access Point (AP) Web server mode.

The Wi-Fi status LED should be blinking code 1.

You can connect any Wi-Fi enabled device to it (laptop or smart phone) and use a Web browser (eg Chrome) on this device to setup or control the Energizer.

The SSID of the Energizer is JVA_Jumbo_xxxxxx where xxxxxx is the Serial Number of the unit.

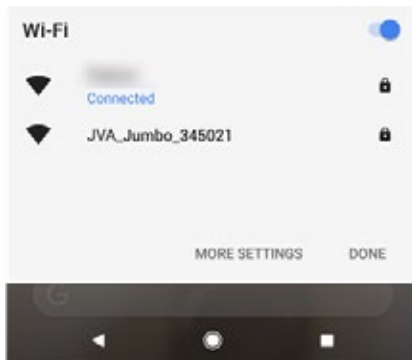

The connection is password protected.

The default password is: jvasecure

Enter the password and press CONNECT

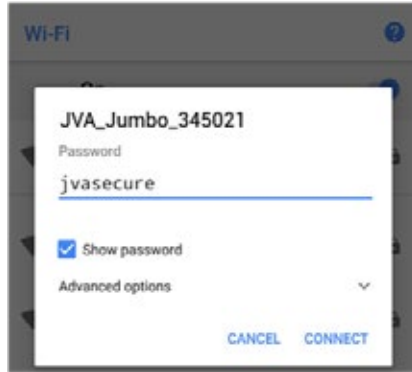

This interface does not have an internet connection and some devices will ask you if you want to remain connected. Ensure you click on the “Tap for options” if it asks.



To ensure you can access the Web Interface, you need to answer YES to the “Stay connected?” questions. Tick the box “Don’t ask again” if you will be connecting to this device more than once.

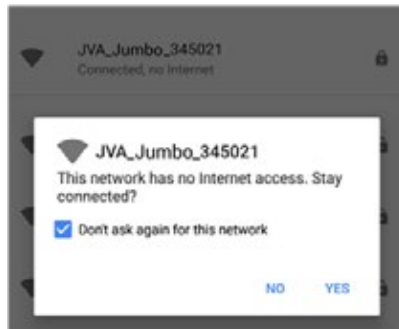

Open your browser and connect to the following IP address 192.168.4.1 or you can use the following QR code.



8.2 CONFIGURATION PAGE (OPTION PROGRAMMING)

The configuration page has various options. It only shows the relevant options for the configured device. To access this page, select “Device Setup” from the main page, then enter the password: “12345”, as seen below:

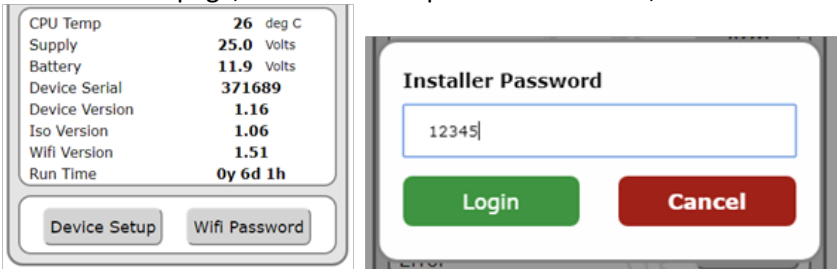

Select “Login” and the configuration page will open.

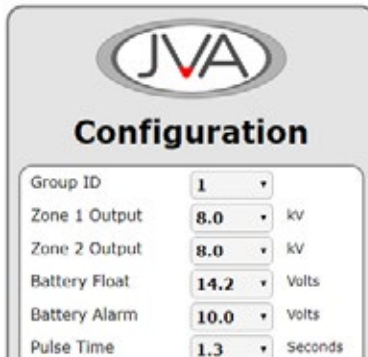

8.3 SECTOR PROGRAMMING GUIDE

If the device is a JMBx-ZM50, an option is available to set the number of sectors from 0 to 50. Select the amount of sectors required now, before selecting the “Sectorize” button, which is now available down the bottom of the configuration page.

The screenshot shows a configuration interface with the following elements:

- Sectors:** A dropdown menu set to 0.
- Gate Delay:** 0 sec
- Entry Delay:** 1 sec
- Exit Delay:** 2 sec
- Siren On Time:** 3 sec
- Siren Off Time:** 4 min
- Monitor Type:** ZM50
- Input 1:** Arm Zone 1 Swl
- Input 2:** Arm Zone 2 Swl
- Input 3:** Alarm Gate N/C
- Output 1:** Siren Zone 1 or 2
- Output 2:** Strobe Zone 1
- Output 3:** Strobe Zone 2
- Emulate Mk1:**
- Distance Fault Detection:**
- Buttons:** Save Settings, Reload Settings, Main Page, Factory Default, and Sectorize.

After selecting the “Sectorize” button, a new page will display each sector, and the percentage along the fence that each sector covers. To set up sectors manually on a fence, follow the guide in section 10.

The screenshot shows the Sectorize page with the following elements:

- JVA Logo:** At the top center.
- Sectorize:** Title with a green signal icon.
- Feed V:** 10.0 kV
- Feed 1:** 0 Amps
- Feed 2:** 0 Amps
- Distance:** 0.00 %
- Sector:** 1
- Buttons:** Arm, Disarm, Clear, Mute, +, -, Save.

To exit back to the main page, select “Finish”.

8.3.1 SAVING SECTOR DETAILS TO MODULE



To save the sector details to the Virtual Keypad, select the “Copy to Module” button from within the Sectorize options page. This allows the Virtual Keypad to hold the information of the sectors that have been set from the energizer.

To exit back to the main page, select “Finish”.

8.3.2 SAVING SECTOR DETAILS TO DEVICE



To load the sector settings from the Virtual Keypad onto the energizer, select the “Copy to Jumbo” button from within the Sectorize options page. This allows previously configured sector options to transfer from a previously configured energizer to the current one.

To exit back to the main page, select “Finish”.

8.4 CONTROL AND MONITOR PAGE

8.4.1 ARM AND DISARM

The main page is the basic control hub with buttons to arm and disarm the energizer.

8.4.2 MUTING

The “Mute” button available on both zones (for a ZM2), or one zone (for a ZM1 or ZM50) will mute any actively sounding alarms from a siren output that will have occurred on the fence. This does not clear any latched alarms; this simply silences any siren that has been configured as an output on that zone.

8.4.3 CLEAR

The “Clear” button is available on both zones (for a ZM2), or one zone (for a ZM1 or ZM50) and it will clear any latched alarms but will not stop the siren from sounding. To stop an output that has been configured as a siren, the “Mute” button must be selected for that zone.

9 INSTALLATION

9.1 INSTALLATION STEPS

1. Ensure that you have read through this manual first!
2. Design and build the fence. (Beyond the scope of this guide)
3. Decide where the JMB energizer is to be mounted. If on an external wall it should be housed within an equipment box and not in direct sunlight.
4. Remove the 4 plastic bolts that tighten the lid of the enclosure
5. Use the provided concrete screws. The mounting holes are below the 4 large plastic lid bolts. Screw the enclosure to mounting wall.
6. Wire the low voltage cables to the PCB terminals passing through the small cable glands.
7. Wire the fence and earth cables to the fence terminals passing through the large cable glands.
8. The **unused black glands** should be sealed with a short length of round cable, to prevent insects from making their way inside.
9. Fit the battery leads to the battery through the small cable glands.
10. The Error LED should be blinking twice to show mains fail.
11. The Energizer is designed not to start when first powered up irrespective of the state of the Control Inputs.
12. Attach the Lid using the 4 plastic bolts.
13. Turn AC power onto the 24Vdc power pack.
14. Arm the JMB using the switch on the right side of the enclosure or by using the Virtual Keypad (refer to the Virtual Keypad section).
15. The Virtual Keypad or a connected Keypad will now show the fence voltage(s) and current(s).
16. Lastly, find and remove any faults on the fence.

9.2 CONFIGURATION JUMPERS

The JMB has several special purpose jumpers located on the main PCB.

| Jumper | Function | Purpose |
|--------|---|---|
| J4 | Factory default jumper Normally On (fitted) Off to return programmable options to factory defaults on power up. | If the Energizer needs to be defaulted to factory settings, remove all power (24Vdc and battery) and remove the J4 jumper. Reapply power. Reapply J4 and the Energizer will be reset to default settings. |
| J5 | Inhibit internal Beeper | Fitted to inhibit the internal beeper, irrespective of any option setting. |
| J12 | Inhibit IR tamper | Only used by service personal |

9.3 High Voltage Fence Terminals

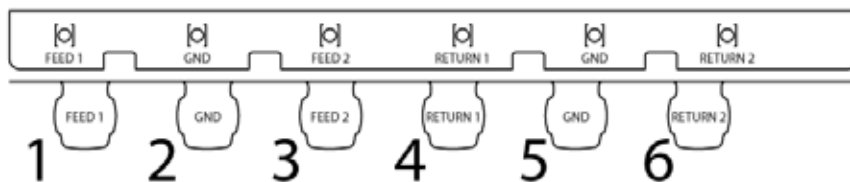

| Model | 1 | 2 | 3 | 4 | 5 | 6 |
|-----------|--------------|--------|------------------|------------------------|--------------------------------|------------------------|
| JMBx-ZM1 | Fence | Ground | F e n c e N/C | Return 1 (optional) | Ground Return (optional) | Return 2 N/C |
| JMBx-ZM2 | Z o n e 1 | Ground | Zone 2 | Return 1 (optional) | Ground Return (optional) | Return 2 (optional) |
| JMBx-ZM50 | F e e d 1 | Ground | Feed 2 | N/C | Ground Return (optional) | N/C |

10 FENCE WIRING DIAGRAMS

10.1 JMBX-ZM1

10.1.1 MONITORING FROM THE START OF THE FENCE

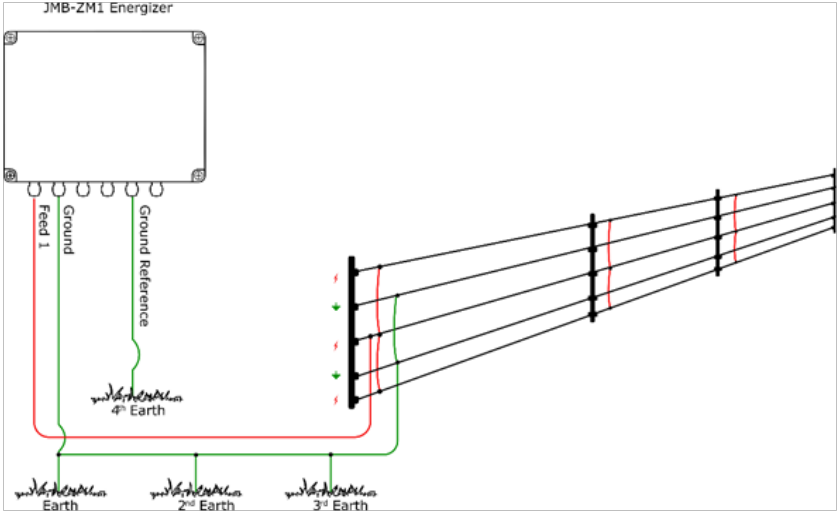

10.1.2 MONITORING FROM THE START AND END OF THE FENCE

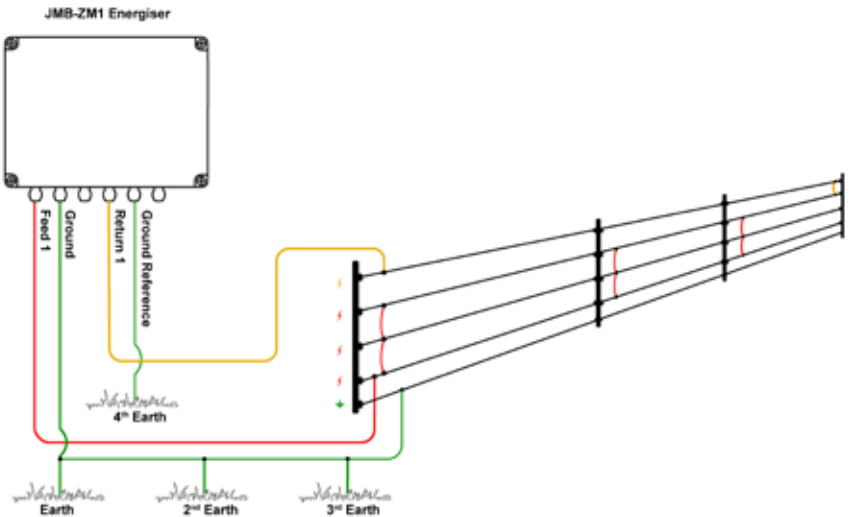

10.2 JMBX-ZM2

10.2.1 MONITORING FROM THE START OF THE FENCE

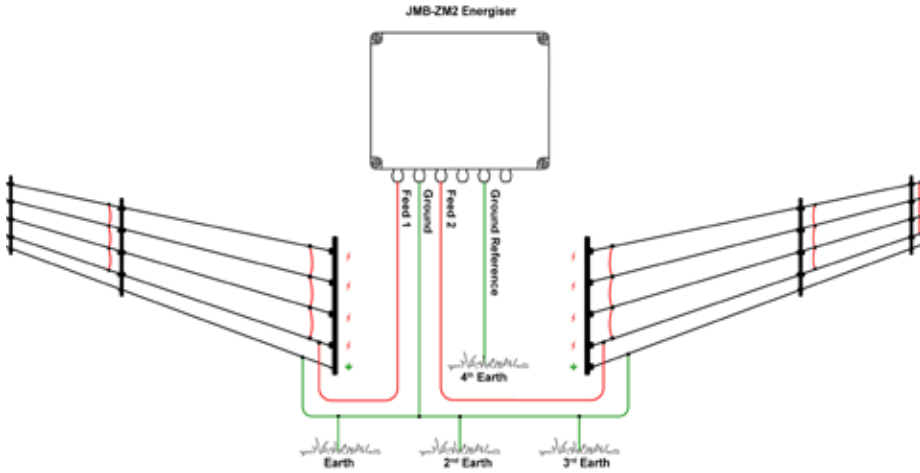

10.2.2 MONITORING FROM THE START AND END OF THE FENCE

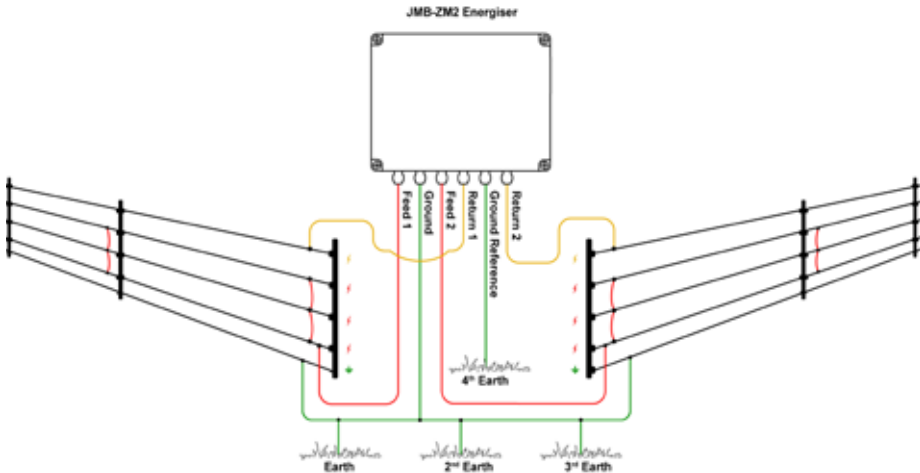

10.3 JMBX-ZM50

10.3.1 MONITORING 50 SECTORS ON A FENCE

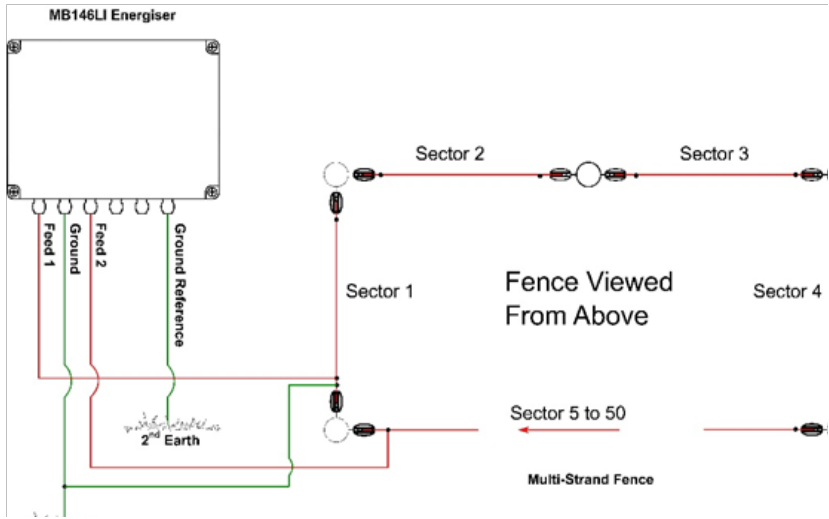

10.3.2 WIRING A SECTORIZED FENCE

Although series live wiring is recommended for higher security, on very long fences parallel wiring may be used. Parallel wiring can result in a fault not being reported if a live wire is cut. If parallel wiring is used, then the live wires should be paralleled up at both ends of each sector.

Ground wires may also be in series or parallel. Series ground wiring is only useful if you are using ground loop monitoring. Parallel ground wires should also be paralleled up at both ends of the sector.

See Next page for detailed diagrams.

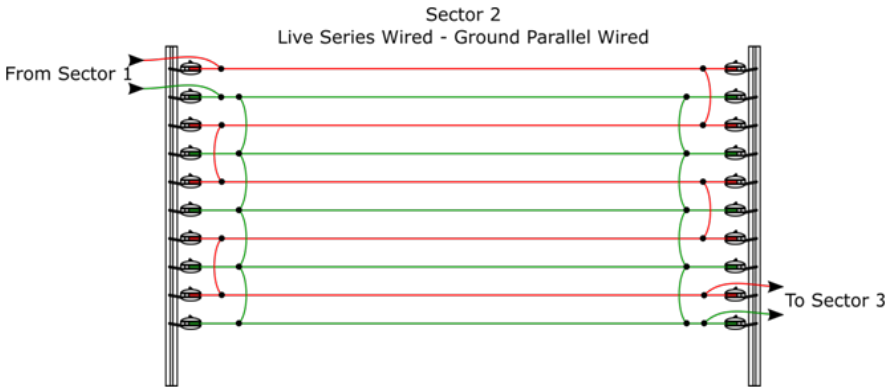
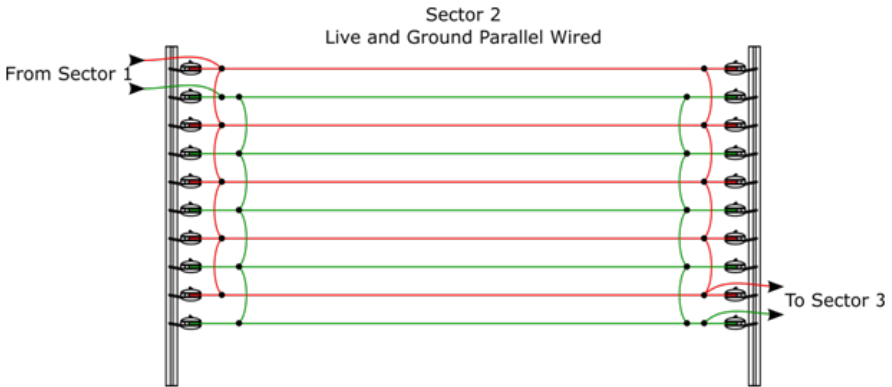
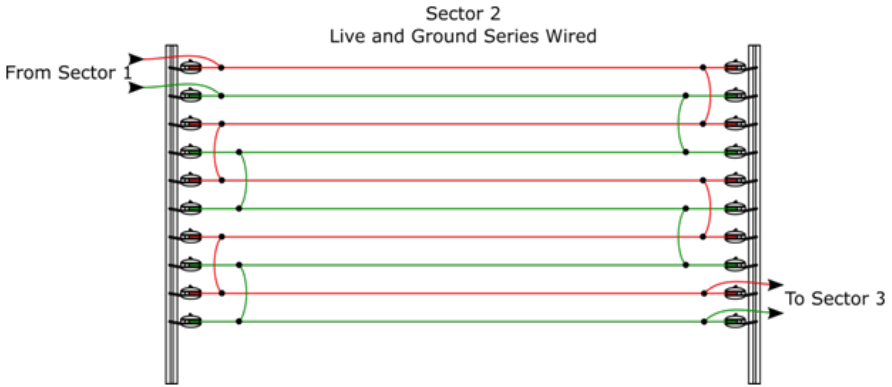

10.3.3 SECTOR DIVIDER

In order to maintain the highest level of sector reporting accuracy a Sector Divider may be wired between sectors on the fence. This is required when one or more of the sectors is very short and is also recommended between sectors which differ in construction, for example between wall top and free-standing sectors.

Note: When programming the sector splits into the JMB energizer, place the short to ground on the mid (normally unused) terminal of the Sector Divider. This means that the sector split is recorded at the theoretical mid-point inside the divider and any real fence short will always be outside.

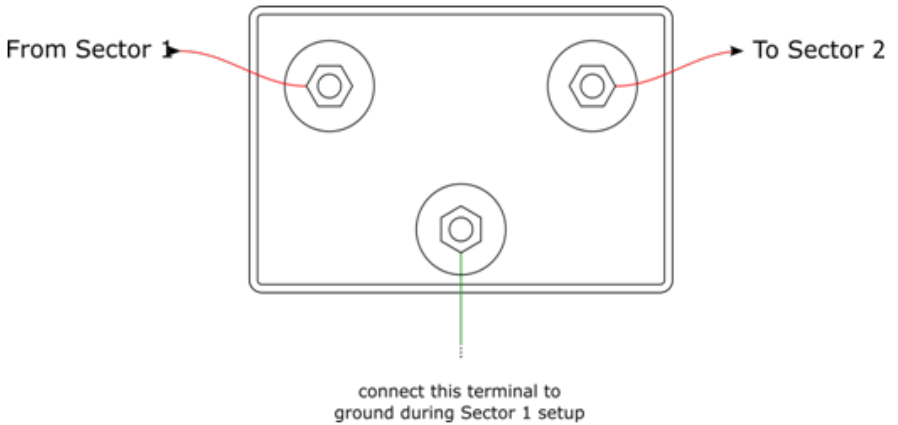

10.4 LOW VOLTAGE TERMINALS

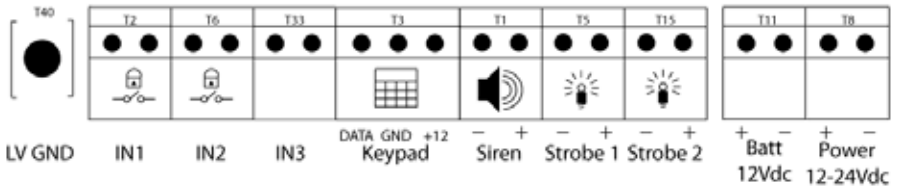

If no battery is connected, the combined power for all 3 outputs can only be less than 0.5A.

| Label | Type | Description |
|----------------|-------|--|
| LV_GND | 1 Way | Lightning Ground for the signal area. Connect to local earth or shields. |
| IN1 | 2 Way | Energizer control input (dry contact or 0-12V Note 1). User defined operation and polarity. Default Arm Zone 1 |
| IN2 | 2 Way | Energizer control input (dry contact or 0-12V Note 1). User defined operation and polarity. Default Arm Zone 2 |
| IN3 | 2 Way | Energizer control input (dry contact or 0-12V Note 1). User defined operation and polarity. Default Gate alarm input |
| Keypad | 3 Way | Standard Pakton/JVA Keypad bus Mk2. Supplies power and data line for an external keypad. The +12V source on these terminals is protected with 1A self resetting fuse. |
| Siren | 2 Way | Switched 12 volt output. Low side switched. 35W max (including strobes). A buffer relay should be used when connecting these outputs to an alarm panel. Default Siren Zone 1/Zone 2 |
| Strobe 1 | 2 Way | Switched 12 volt output. Low side switched. 35W max (including siren). A buffer relay should be used when connecting these outputs to an alarm panel. Default Strobe Zone 1 |
| Strobe 2 | 2 Way | Switched 12 volt output. Low side switched. 35W max (including siren). A buffer relay should be used when connecting these outputs to an alarm panel. Default Strobe Zone 2 |
| Batt 12Vdc | 2 Way | Connect to an external 12V rechargeable lead acid battery. |
| Power 12-24Vdc | 2 Way | 24V DC from the JMB power pack. |

Note 1: If using 0-12V into any of the control inputs you may need to add a 1k Ohm resistor across the input.

10.5 LOW VOLTAGE WIRING DIAGRAMS

10.5.1 MAINS

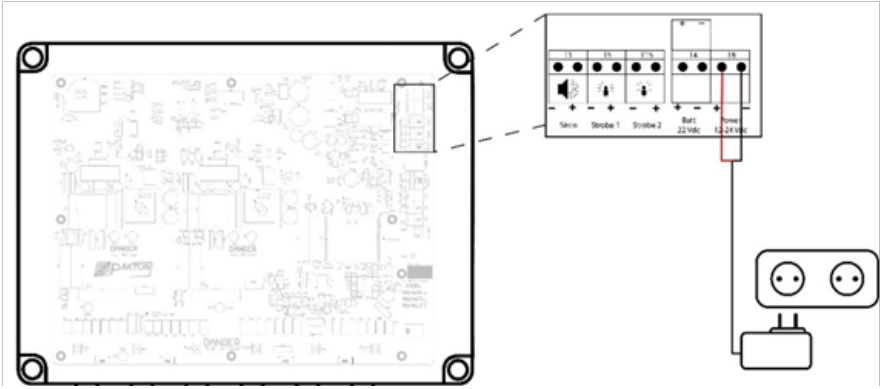

10.5.2 MAINS AND RECHARGEABLE BATTERY

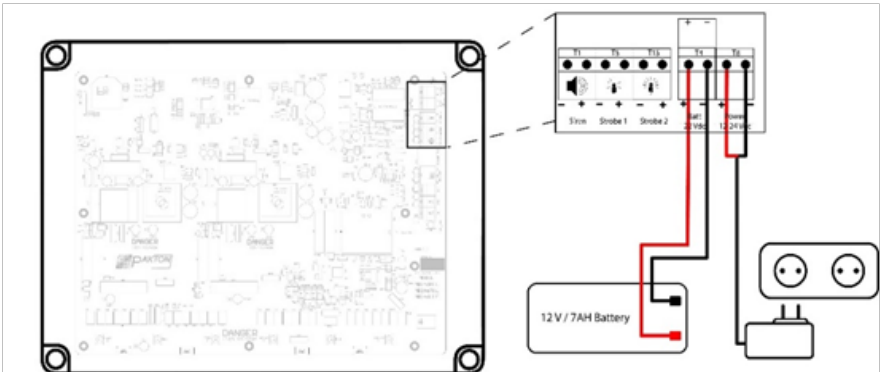

10.5.3 SOLAR POWERED

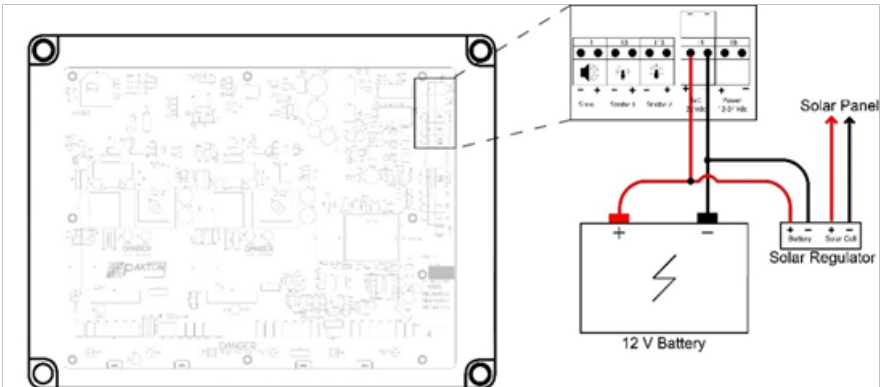

10.5.4 INPUTS

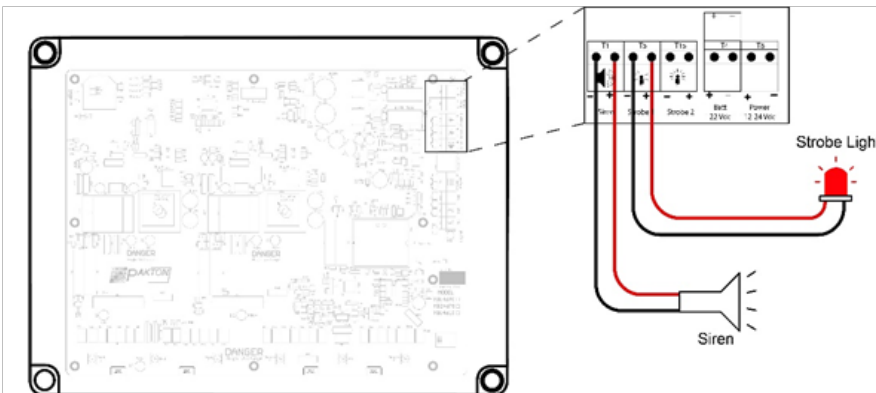
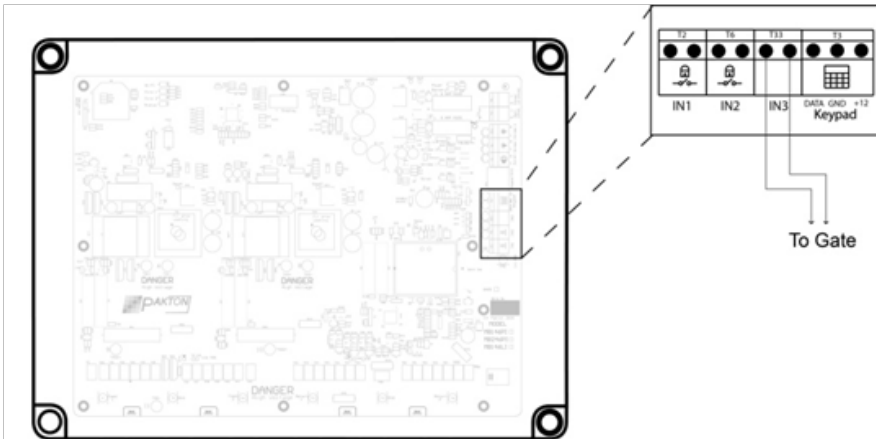
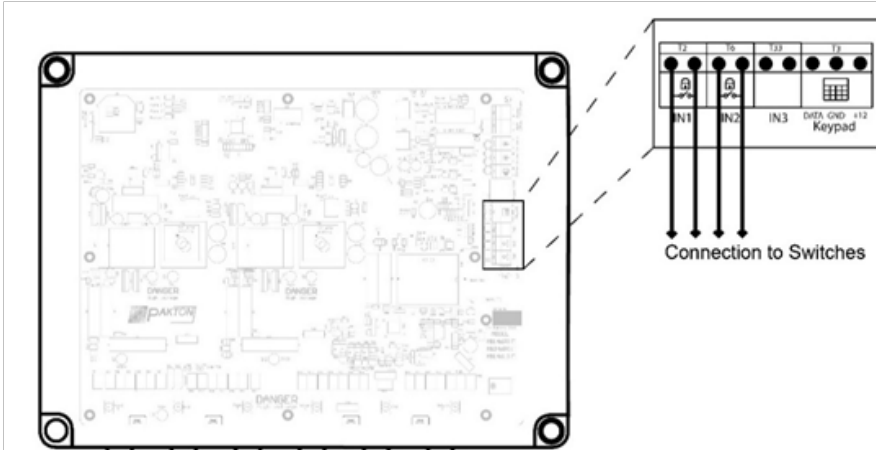

10.5.5 KEYPAD

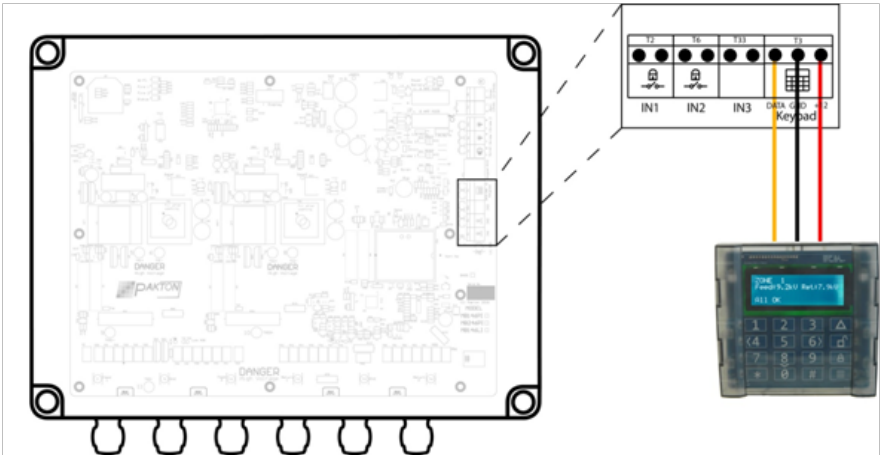

10.5.6 PERIMETER PATROL

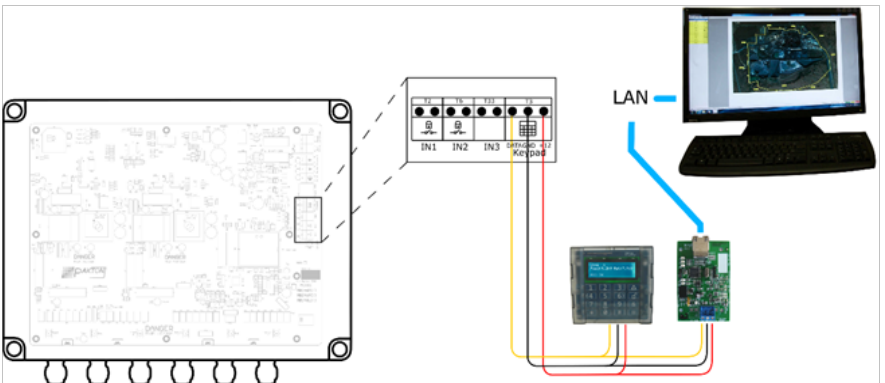
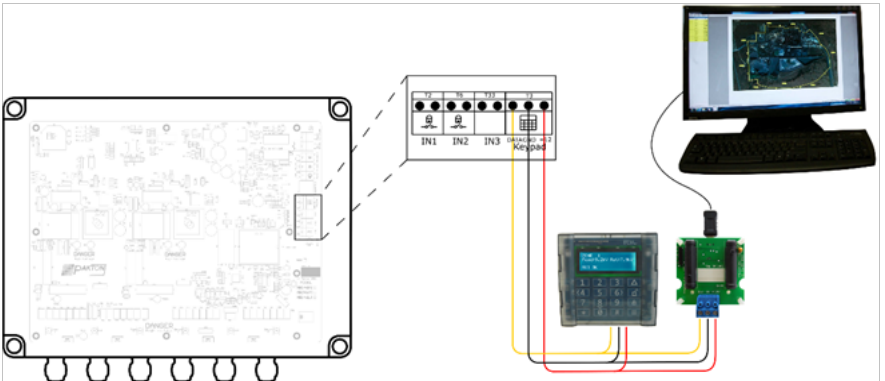

10.5.7 CLOUD ROUTER

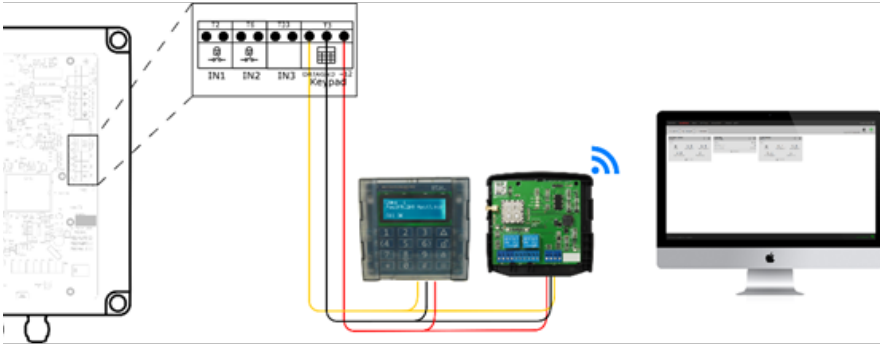

10.5.8 SURGE PROTECTION

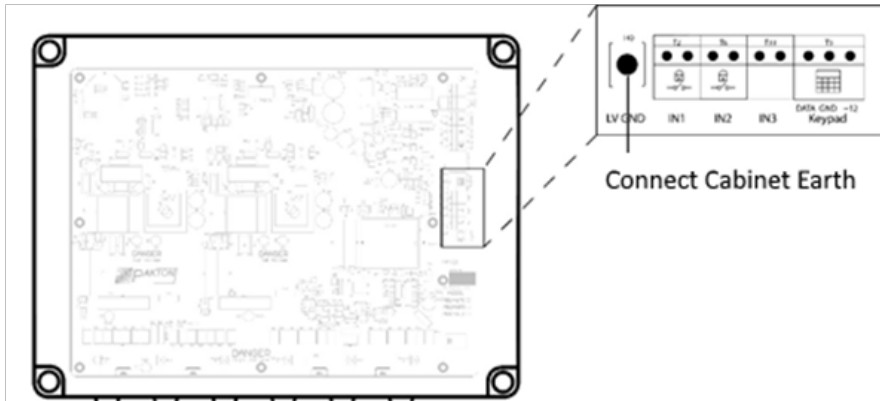

Note: **Do not** connect LV GND to the fence earth rod. It may be connected to a cabinet earth

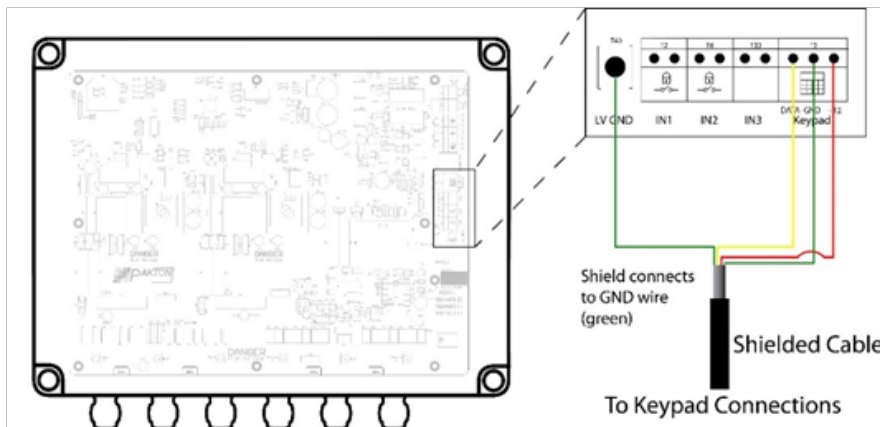

11 CONFIGURATION OPTIONS IN DETAIL

11.1 GROUP ID

A keypad bus group must have only 1 master. The other Energizers/Monitors in the group are slaves.

If the group contains Z series energizers and monitors, then an energizer should be the master.

Virtual Keypad: Enter the **Configuration** page and alter the **Group ID** value. Click **Save Settings**.

11.2 HIGH POWER MODE POWER LEVEL (ZONE 1)

The High-Power mode power level option allows the shocking power of the fence to be adjusted. The actual fence voltage depends on the amount of fence wire and fence conditions. This option may affect the average power drain and therefore backup battery time.

Range 3.0 to 9.9kV. Default 8.0kV

Virtual Keypad: Enter the **Configuration** page and adjust **Zone 1 Output** accordingly. Click **Save Settings**.

11.3 HIGH POWER MODE POWER LEVEL (ZONE 2)

JMBx-ZM2 only

This high power mode is identical to the high power mode described above, although this is implemented on the second zone output.

Range 3.0kv to 9.9kV. Default 8.0kV

Virtual Keypad: Enter the **Configuration** page and adjust **Zone 2 Output** accordingly. Click **Save Settings**.

11.4 BATTERY CHARGER FLOAT VOLTAGE

This option is used to set the battery charger float value, the correct setting depends on the type of rechargeable 12V battery used.

Range 10.0V to 16.0V. Default 14.2V

Virtual Keypad: Enter the **Configuration** page and adjust **Battery Float** accordingly. Click **Save Settings**.

11.5 BATTERY ALARM VOLTAGE

This option sets the battery voltage threshold below which the general alarm will activate. This alarm can be set to activate one of the relays and is part of the General alarm.

Note: The energizer will not turn off with this alarm, however if the battery voltage continues to fall it will eventually switch off.

Range 0.0V to 16.0V. Default 10.0V

Virtual Keypad: Enter the **Configuration** page and adjust **Battery Alarm** accordingly. Click **Save Settings**.

11.6 RF REMOTE ID

This feature enables the energizer to be controlled via a JVA fence line, radio frequency (RF), Remote Control*. If a fence line remote control is to be used with this energizer, the option must be changed to match the ID of that remote. Check the user manual of the remote control.

Default 0 (disabled).

Virtual Keypad: Enter the **Configuration** page and alter the **RF Remote ID** value. Click **Save Settings**.

*Compatible with one other manufacturer's Remote Control.

11.7 PULSE TIME

Sets the period between energizer pulses.

Range 1.0 second to 2.0 seconds. Default 1.3 seconds

Virtual Keypad: Enter the **Configuration** page and adjust **Pulse Time** accordingly. Click **Save Settings**.

11.8 FENCE CUT ALARM

JMBx-ZM50 only

Sets the percentage balance change to either side of 50% for which the Fence Cut alarm will occur. In normal running, with no faults, the fence currents should be well balanced. Meaning the current Feed 1 and Feed 2 will be close to the same value in Amps. When they are equal the balance value is close to 50%.

If the fence is cut the currents will be unbalanced. A setting of 20 means that the Fence Cut alarm will show if the balance moves below 30% or above 70%.

A Fence Short alarm will take precedence over a Cut alarm.

On some fences a fence load device may need to be installed to ensure this alarm worked properly for all fence cuts.

Range 0% to 50%. Default 20%

Virtual Keypad: Enter the **Configuration** page and alter the **Cut Alarm** value. Click **Save Settings**.

11.9 FENCE VOLTAGE ALARM LEVEL (ZONE 1)

Sets the alarm threshold for a Fence Alarm. If the fence voltage decreases below this threshold for more than the Fence Alarm Delay a fence alarm will occur.

A Fence Short alarm takes precedence over this alarm.

Warning: Setting this level to higher than the normal running voltage of the fence will result in continuous fence alarms.

The JMBx-ZM50 uses the Feed 1 voltage as the fence voltage.

The other models use the Feed (or Return, if available) voltages as the fence voltage.

Range 0kV to 7.0kV. Default 4.0kV

Virtual Keypad: Enter the **Configuration** page and alter the **Voltage Alarm 1** value. Click **Save Settings**.

11.10 FENCE VOLTAGE ALARM LEVEL (ZONE 2)

JMBx-ZM2 Only

For the JMBx-ZM2, a second fence voltage alarm applies only to the second zone.

Range 0kV to 7.0kV. Default 4.0kV

Virtual Keypad: Enter the **Configuration** page and alter the **Voltage Alarm 2** value. Click **Save Settings**.

11.11 CURRENT ALARM LEVEL (ZONE 1)

Sets the alarm threshold for a Fence Short alarm. If the feed current on Zone 1 rises above this level for more than the Fence Alarm Delay (Pulse count) a fence alarm will occur.

This value must be set below the Feed 1 current, shown when a short is placed at the midpoint of the fence. The Sector is only shown after a Fence Short alarm occurs.

Range 0A to 150A. Default 20A

Virtual Keypad: Enter the **Configuration** page and adjust **Current Alarm 1** accordingly. Click **Save Settings**.

11.12 CURRENT ALARM LEVEL (ZONE 2)

JMBx-ZM2 Only

For the JMBx-ZM2, a second fence current alarm applies only to the second zone, independent from the first zone.

Range 0A to 150A. Default 20A

Virtual Keypad: Enter the **Configuration** page and adjust **Current Alarm 2** accordingly. Click **Save Settings**.

11.13 GROUND VOLTAGE ALARM LEVEL

Sets the voltage above which the fence ground alarm will occur. If a difference in voltage is measured between the Ground and Ground reference fence terminals of above this level for more than the Fence Alarm Delay (Pulse count) a ground alarm will occur.

This can be used to monitor for Ground stake voltage or fence ground circuit voltage depending on the fence wiring.

This setting is irrelevant if the Ground and Ref Ground terminals are connected together.

Range 0kV to 5.0kV. Default 1.0kV

Virtual Keypad: Enter the **Configuration** page and adjust **Ground Alarm** accordingly. Click **Save Settings**.

11.14 FENCE ALARM DELAY (PULSE COUNT)

This option sets the delay from the moment an alarm occurs to when it is reported. Setting this too low will result in false alarms.

Range 1 second to 90 seconds. Default 30 seconds

Virtual Keypad: Enter the **Configuration** page and adjust **Pulse Count** accordingly. Click **Save Settings**.

11.15 ANTI-BRIDGING

Anti-bridging has been designed to detect a section of fence being by-passed, and removed from circuit, by an intruder bridging the feed to returns together and then cutting the live wires in between.

While Armed, a fence alarm will trigger if the fence voltage rises OR falls quickly by more than the threshold. A slow change to the voltage will not trigger a fence alarm until the voltage is less than the Fence Voltage alarm level (option 20 or 21). The Anti-bridging Threshold is a percentage value of the current fence voltage.

For Example, if you have a 10% Anti-bridging Threshold. At this level a fence (return) voltage normally reading 7.5kV will trigger a fence alarm if the voltage quickly rises to over 8.3kV or falls to less than 6.7kV.

NOTE: Fence Voltage Power Level (option 2 or 3) must be set higher than the normal fence running voltage, otherwise if the load is released (fence bridged) voltage control will limit the voltage rise and the anti-bridging alarm will not activate. This feature will not operate in low power mode. For the above example, option 2 (or 3 if you are using Zone 2) must be set to 7.0kV or greater to allow the un-loaded fence to rise to 8.3kV or higher, thus triggering the Alarm.

Range 0% to 90%. Default 0%

Virtual Keypad: Enter the **Configuration** page and adjust **Anti-bridge** accordingly. Click **Save Settings**.

11.16 DFD™

DFD™ enables the JMB to detect a fault at the end of very long fences. Instead of only measuring the peak current the JMB with DFD™ calculates the “real” current and rejects the “reactive” current.

The current displayed will usually be less than read by a standard hand-held meter with this feature on. There is no theoretical limit to the length of fence that the JMB can monitor with this feature on. Without DFD™ the limit is approximately 10km.

Default OFF.

Virtual Keypad: Enter the **Configuration** page and select or deselect Distance Fault Detect accordingly. Click **Save Settings**.

11.17 SECTORS

JMBx-ZM50 Only

This option allows your electric fence to be split up into sectors (sections of fence). When a fault occurs (as defined by the total current exceeding the “current alarm level”) the energizer will determine which sector the short is in.

Each sector division needs to be programmed into the energizer. The sector programming procedure is outlined in [Section 12 “Sector Programming Method”](#).

The energizer cannot show more than 1 faulted sector at any time

Range 0 to 50. Default 0

Virtual Keypad: Enter the **Configuration** page and adjust **Sectors** accordingly. Click **Save Settings**.

11.18 INPUT PROGRAMMING

All inputs can be set to any of the available functions (user assignable), all input functions are selectable from a drop down list for each of three input terminals.

11.19 INPUT FUNCTIONS

This option allows the input 1 contact to be configured for different alarm types.

Options: See following table

Default:

Input 1: Arm Zone 1

Input 2: Tamper (OR Arm Zone 2 [ZM2 only])

Input 3: Alarm Gate

| Mode | Description |
|------------------|--|
| Arm Me | Arm the Energizer |
| Arm Zone 1 | Arm Zone 1 of the Energizer |
| Arm Zone 2 | Arm Zone 2 (ZM2 Only) of the Energizer |
| Arm Group | Arm the Energizers connected to the Keypad Bus (Not Implemented) |
| Alarm Instant | Alarm triggers when contact changes |
| Alarm 3sec | Trigger an alarm state after 3 seconds |
| Alarm Gate 1 | Gate 1 Alarm. Use the Gate Delay value to set a timeout before the alarm |
| Alarm Gate 2 | Gate 2 Alarm. Use the Gate Delay value to set a timeout before the alarm |
| Alarm Exit/Entry | This is an Entry/Exit route contact. Configure the Entry Delay and Exit Delay |
| Entry Route | This is an Entry route contact. Configure the Entry Delay |
| Exit Route | This input does not affect the operation of the Energizer. Its value is sent via the Keypad bus |
| Pass Thru | This input does not affect the operation of the Energizer. Its value is sent via the Keypad bus |
| Tamper | This will trigger the Tamper Alarm immediately |
| Shutdown | This will trigger the Tamper Alarm immediately and Disarm the Energizer. It will not allow the Energizer to be Armed while in alarm state. |

| Mode | Description |
|-----------|------------------|
| Low Power | Not implemented. |

Virtual Keypad: Enter the **Configuration** page and adjust an **Input's first** dropdown list accordingly. Click **Save Settings**.

11.20 INPUT TYPE

This option sets the behaviour of an input, for programming options see above in input functions.

Options: See Following table

Default:

Input 1: Switch

Input 2: N/C (OR Switch [ZM2 only])

Input 3: N/C

| Mode | Description |
|--------|-------------------------|
| N/C | Normally Closed Contact |
| N/O | Normally Open Contact |
| Tag | Magnetic Tag |
| Switch | Switched Contact |

Virtual Keypad: Enter the **Configuration** page and adjust an **Input's second** dropdown list accordingly. Click **Save Settings**.

11.21 GATE DELAY

The Gate Delay is linked to the Input configured as a Gate Input. While Armed, the Gate Timer will count when the Gate Input is Activated. If the Gate remains open for longer than the Gate Delay, the Gate Alarm will trigger. If the Gate closes, the timer will stop and reset.

Range 0 seconds to 255 seconds. Default 30 seconds

Virtual Keypad: Enter the **Configuration** page and adjust **Gate Delay** accordingly. Click **Save Settings**.

11.22 ENTRY DELAY

The gate switch must remain open for longer than the Gate Entry Delay before the gate alarm is triggered.

Range 0 seconds to 255 seconds. Default 30 seconds

Virtual Keypad: Enter the **Configuration** page and adjust **Entry Delay** accordingly. Click **Save Settings**.

11.23 EXIT DELAY

The gate switch must remain closed for longer than the Gate Exit Delay before the gate alarm is triggered.

Range 0 seconds to 255 seconds. Default 30 seconds

Virtual Keypad: Enter the **Configuration** page and adjust **Exit Delay** accordingly. Click **Save Settings**.

11.24 SIREN ON TIME

This option sets the duration of time that the siren will remain on after a fence alarm occurs. After this time the siren will turn off for the Siren Off Time indicated in the table. The siren will sound again if the alarm is still present after this off time has passed.

This may be the subject of local regulations to stop an alarm causing undue disturbance to neighbours, etc.

Note: The Siren On Time will be cut short if the battery falls below the low battery level

Range 0 seconds to 255 seconds. Default 30 seconds

Virtual Keypad: Enter the **Configuration** page and adjust **Siren On Time** accordingly. Click **Save Settings**.

11.25 SIREN OFF TIME

This option sets the amount of time the siren will be off for after the Siren On Time has expired. If an alarm is still present after this off time the siren will sound again.

Range 0 seconds to 255 seconds. Default 30 seconds

Virtual Keypad: Enter the **Configuration** page and adjust **Siren Off Time** accordingly. Click **Save Settings**.

11.26 SIREN CYCLES

This option sets the maximum number of times the siren will sound for the “on time” if the alarm continues. This may be limited by local regulations to stop an alarm causing undue disturbance to neighbours etc.

Note: This is the maximum number of cycles for 1 continuous alarm, intermittent alarm events could cause more than this number of siren soundings.

Range 1 cycle to 9 cycles. Default 3 cycles

Virtual Keypad: Enter the **Configuration** page and adjust **Siren Cycles** accordingly. Click **Save Settings**.

11.27 AUTO REARM TIME

This option sets the time which must elapse before another alarm will sound after the first alarm has timed out (gone completely through its cycles without being turned off). If an event occurs (such as a low fence voltage) which triggers the siren, any other events which would otherwise trigger the siren (such as a gate alarm) will be ignored while the siren is sounding and until after the Auto Re-arm time has passed. A setting of 0 will disable Auto Re-arm. If this time is set to less than the Siren Off Time, the Energizer may re-arm in the “Off” time and the number of Siren Cycles will be reduced.

Range 1 minute to 240 minutes. Default OFF

Virtual Keypad: Enter the **Configuration** page and adjust the **Auto Rearm Time** dropdown list accordingly. Click **Save Settings**.

11.28 RELAY PROGRAMMING

All relays can be set to any of the available functions (user assignable), all relay functions are selectable from a drop down list for each of the three relays outputs.

11.29 RELAY FUNCTIONS

The following table is for use for the relay programming options.

| Mode | Trigger Condition |
|--------------------------|--|
| Zone 1 Alarm | Triggers when Zone 1 is armed AND Any Zone 1 alarm occurs, these include: <ul style="list-style-type: none"> • The Fence Voltage has fallen below the Fence Voltage Alarm Level (Low Voltage) • The Feed Current has increased above the Feed Current Alarm Level (Short) • Anti-bridging • Energizer failure • Fence Cut alarm |
| Zone 1 Alarm or Disarmed | Triggers when Zone 1 is disarmed OR Any Zone 1 alarm occurs, these include: <ul style="list-style-type: none"> • The Fence Voltage has fallen below the Fence Voltage Alarm Level (Low Voltage) • The Feed Current has increased above the Feed Current Alarm Level (Short) • Anti-bridging • Energizer failure • Fence Cut alarm |
| Zone 1 Armed | Zone 1 is Armed |

| Mode | Trigger Condition |
|---|---|
| Zone 2 Alarm (JMBx-ZM2 Only) | Triggers when Zone 2 is armed AND Any Zone 2 alarm occurs, these include: <ul style="list-style-type: none"> • The Fence Voltage has fallen below the Fence Voltage Alarm Level (Low Voltage) • The Feed Current has increased above the Feed Current Alarm Level (Short) • Anti-bridging • Energizer failure • Fence Cut alarm |
| Zone 2 Alarm or Disarmed (JMBx-ZM2 Only) | Triggers when Zone 2 is disarmed OR Any Zone 2 alarm occurs, these include: <ul style="list-style-type: none"> • The Fence Voltage has fallen below the Fence Voltage Alarm Level (Low Voltage) • The Feed Current has increased above the Feed Current Alarm Level (Short) • Anti-bridging • Energizer failure • Fence Cut alarm |
| Zone 2 Armed (JMBx-ZM2 Only) | Zone 2 is Armed |
| Zone 1 or Zone 2 Alarm | Triggers when Zone 1 and Zone 2 is armed AND Any Zone 1 or Zone 2 alarm occurs, these include: <ul style="list-style-type: none"> • The Fence Voltage has fallen below the Fence Voltage Alarm Level (Low Voltage) • The Feed Current has increased above the Feed Current Alarm Level (Short) • Anti-bridging • Energizer failure • Fence Cut alarm |

| Mode | Trigger Condition |
|-------------------------------|---|
| Zone 1 or Zone 2 Armed | Zone 1 or Zone 2 is Armed |
| General Alarm | Triggers on AC Fail, Tamper, Low Battery/Bad Battery, Gate 1 or 2 Alarm or Internal error. Latched (internal errors only) |
| Zone 1 Siren | Triggers on Zone 1 alarm, Gate or tamper. Will time out after the Siren Time Out time. Latched |
| Zone 2 Siren (JMBx-ZM2 Only) | Triggers on Zone 2 alarm, Gate or tamper. Will time out after the Siren Time Out time. Latched |
| Zone 1 or Zone 2 Siren | Triggers on Zone 1 or Zone 2 alarm, Gate or tamper. Will time out after the Siren Time Out time. Latched |
| Zone 1 Strobe | Triggers on Zone 1 alarm, Gate or Tamper. Only turns off on Energizer disarm. Latched |
| Zone 2 Strobe (JMBx-ZM2 Only) | Triggers on Zone 2 alarm, Gate or Tamper. Only turns off on Energizer disarm. Latched |
| Zone 1 or Zone 2 Strobe | Triggers on Zone 1 and Zone 2 alarm, Gate or Tamper. Only turns off on Energizer disarm. Latched |
| AC Failure | Triggers on AC Fail |
| Low/Bad Battery | Triggers on low or bad battery |
| Tamper Alarm | Triggers when the case has been opened and J12 has been fitted |
| Gate 1 Alarm | Triggers on Gate 1 |
| Gate 2 Alarm | Triggers on Gate 2 |
| Gate 1 or Gate 2 Alarm | Triggers on Gate 1 or Gate 2 |
| Input 1 Alarm | Input function must be set to Alarm Input |
| Input 2 Alarm | Input function must be set to Alarm Input |
| Input 3 Alarm | Input function must be set to Alarm Input |

| Mode | Trigger Condition |
|------------------------------|---|
| Host Control | This Relay is completely controlled from a Host system such as Perimeter Patrol or a Keypad. If the Host system is disconnected from the Energizer for more than 30 seconds, the Relay will automatically change to the Alarm State |
| Host Control - Not Fail Safe | This Relay Host Controlled however if the Host system is disconnected then the Relay will maintain its current state |
| Group Armed | Triggers when group is armed. Only configurable on group master |
| Group General | Triggers on group general alarm. Only configurable on group master |

Note 1: The siren and strobe switched 12V outputs can be used to drive external buffer relays.

11.30 PROGRAMMING WITH THE VIRTUAL KEYPAD

The Virtual Keypad provides an easy solution for programming the JVA JMB series energizers.

To access programming mode, ensure you are connected to the energizer and see the main webpage on your Virtual Keypad. At the bottom click on the **Device Setup** button and enter the Installer Password. Press the **Login** button when you have entered the password.

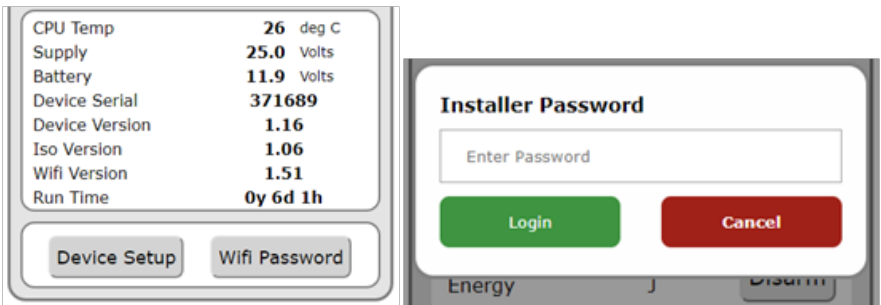

The default Installer Password is **12345**.

You will now be redirected to the Configuration page.

The settings are arranged in rows and you can see the name of the specific programming options on the left side. Depending on the option you are changing there will be 3 different methods of changing the value.

The first is by sliding the green button on the screen from left to right, where left is the lowest values and the right is the higher values. The selected value will be displayed on the right side. To scroll down to more options, swipe up on the left side of the screen. If you try this in the middle section, you may accidentally change one of the slider settings. If you need more accuracy in using the sliders for a value, rotate your Phone/Tablet to landscape.

The second is a check box selection, which is used for options that only require an on and off value.

The third is a drop-down box which can be changed by clicking on the box. This will open a list of options which you can click on to select that settings.

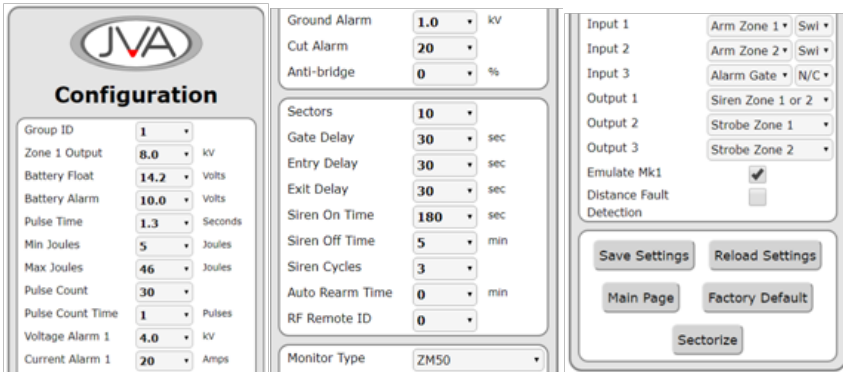

| Button Type | Description |
|-----------------|---|
| Save Settings | Click this to save all the options that have just been configured |
| Reload Settings | Click this to reset the values that have just been changed |
| Main Page | Click this to return to the main page |
| Sectorize | Click this to configure the JMBx-ZM50 sectors. Remember to se the Sector value first and press Save Settings before accessing this page. |
| Factory Default | Click this button to reset all settings to a factory default state. You will need to go through the Wi-Fi configuration process again. |



12 SECTOR PROGRAMMING METHOD - LOOP MONITOR (JMBX-ZM50 ONLY)

In order to determine which Sector the fault is in, the system must be programmed with the end position of each sector (the division between each sector, also known as the sector “split”).

NOTE: Make sure the energizer cover is on if there is any chance of sunlight hitting the PCB. Bright light shining on the IR optical couplers will cause errors in the readings.

12.1 USING THE VIRTUAL KEYPAD

1. Clear the settings

When first setting up a new fence leave sectoring off until you are sure the fence is working correctly and there are no faults. If the sectoring system was previously on, turn it off now to clear the settings by changing the **Sector** value to 0 and click **Save Settings**.

2. Check the Fence

Check the fence by running over it, using a JVA Fault finder (Pakton Power Probe). The current from each feed terminal (feed 1 and 2 measured at the fence) should be the same, or very similar. If one is much higher than the other, you may have a fault in which case do not proceed until you find and eliminate all faults.

3. Check the Energizer goes into current alarm

Place a link from Feed 1 to Feed 2 at the JMBx-ZM50 terminals, leaving the wiring to the fence in place.

(Instructions continue on the next page)

Place a short (using an alligator to alligator “jumper” cable) on the fence at approximately the midpoint (end of sector 10 for a 20-sector fence) from live to a ground wire. This represents the hardest fault to detect, as other positions will draw more current.

Turn the fence (energizer) on.

Check that the energizer goes into alarm. If it does not, reduce the **Current Alarm Level** and then click **Save Settings**.

Tips:

- To ensure the energizer goes into “current” alarm change **Fence Voltage Alarm level** to 0 and turn Anti-bridging off, then click **Save Settings**.
- Since the sector programming means placing intentional shorts on the fence, to stop alarms sounding: Remove any connection to a siren and change the **Siren on Time** to 0. Finally set the **Pulse Time** (or cycle time) to the maximum value to provide enough time to read the Fence Current once the system is settled. Click **Save Settings**.
- On the main page observe the minimum Feed Current. Go back to the **Configuration** page and change the **Current Alarm 1** to a value less than the minimum Feed Current that you saw on the main page. Click **Save Settings**.

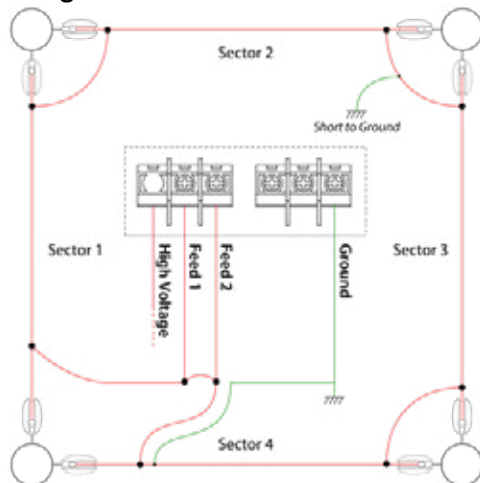

4. Check the Current Balance

With the link and fence short still in place (from step 3):

Check that the position reading is at 50% of full fence length.

Note that you can view the balance by going to the **Sectorize** page at any time.

If the reading is not very close to 50%, you will need to re balance the current sensors by selecting the “balance” option.

Note: The energizer will not re-balance if either current is less than 5A or greater than 75A.

If you cannot achieve balance do not proceed. Contact your JVA dealer for help.

Assuming the fence is balanced, disarm the energizer (turn the fence off).

Remove the link from Feed 1 to Feed 2 at the energizer terminals.

Remove the short that was placed on the fence from step 3.

5. Engage Sectoring

Go to the **Configuration** page and set the Sector to 20 (for 20 sectors, or however many sectors the fence has). Click **Save Settings**.

6. Record sector end points

Place a short (using an alligator to alligator “jumper” cable) at the very end of sector 1 between live and earth preferably using the fence earth wire nearest the exit point of sector 1. Sector 1 is the sector directly powered from the Feed 1 terminal.

If you are using a Sector Divider (PTE0063) place the short from the centre terminal to ground.

When the energizer goes into alarm it will display Sector 1 - Short and the position (as a percentage of the whole fence length).

Make sure the readings are steady, if it is fluctuating wait until it settles.

Within the **Sectorize** page select sector 1 (or whatever sector you are on) by using the + or -. Then click **Save**.

Record the position percentage in the table provided in section [Site sector record](#).

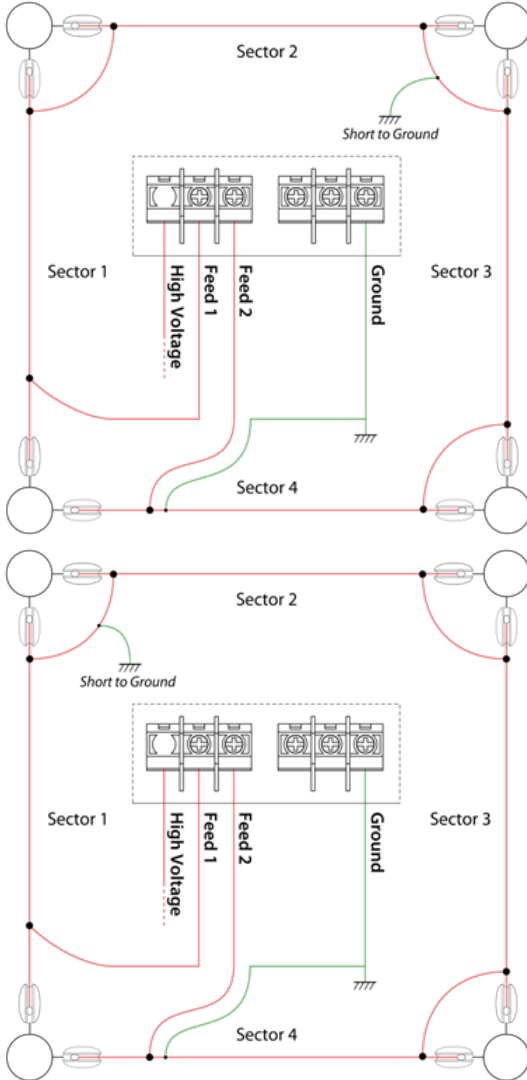

Remove the short at the end of Sector 1 and move it to the end of Sector 2. When the energizer goes into alarm it will display Sector 2 – Short.

On the **Sectorize** page click on the + to select the new sector and then click **Save**.

Record the position percentage in the table provided below.

Continue to move the short to each sector end and select a new sector on the **Sectorize** page. Click **Save**.

Note: The last short will be placed at the end of Sector 19 for a 20 sector fence, not at the end of Sector 20 as this is directly connected to Feed 2.

Sectors **MUST** be entered in sequence. The Virtual Keypad main page will show the ‘expected’ Sector number when a short is applied.

7. Confirm the Sector Percentages are correct

Check the table of sector end positions (percentages) you recorded. If you missed any you may click the + and – on the **Sectorize** page and then click **Read Sector** to see the value for that sector.

These numbers must be in increasing order! If for example the reading for end of sector 3 is lower than that for sector 2, something is wrong. If the sectors are short and there is no difference between the reading for one sector and the next you may need to fit a passive sector definer between them. There should be approximately 5.00% difference between each sector.

If a mistake is made, individual sector information can be manually altered. This is available in the “Sectorize” page by selecting the “Manual Sector” button, inputting which sector number is to be altered, and its appropriate value.

8. Check the sector positions are working

After recording all the sector end points, return to sector 1 and place a short somewhere on Sector 1. Check that energizer reports Sector 1. If you are close to the end of sector 1 energizer may report Sector 1 and 2 (alternating).

9. Restore the alarm settings

Remember to set and check the **Voltage Alarm 1, Anti-bridging** settings back to their original values you had.

If you removed siren wiring in step 3 and or inhibited the onboard beeper (J5) restore them to their correct settings and check that they operate.

NOTE: If after sector programming the fence, it is altered (wires added or removed) or sector dividers are added, each individual sector can be altered to adjust for the change in fence behaviour.

12.2 SITE SECTOR RECORD

Recording the actual sector split positions will help in fault finding later

| Sector End | Position (% of total fence length) | Feed 1 Current (Amps) | Feed 2 Current (Amps) | Fence Volts (kV) |
|------------|------------------------------------|-----------------------|-----------------------|------------------|
| 1 | | | | |
| 2 | | | | |
| 3 | | | | |
| 4 | | | | |
| 5 | | | | |
| 6 | | | | |

| Sector End | Position (% of total fence length) | Feed 1 Current (Amps) | Feed 2 Current (Amps) | Fence Volts (kV) |
|------------|------------------------------------|-----------------------|-----------------------|------------------|
| 7 | | | | |
| 8 | | | | |
| 9 | | | | |
| 10 | | | | |
| 11 | | | | |
| 12 | | | | |
| 13 | | | | |
| 14 | | | | |
| 15 | | | | |
| 16 | | | | |
| 17 | | | | |
| 18 | | | | |
| 19 | | | | |
| NO SHORT | (Balance - Use "Balance") | | | |

13 WARRANTY

This product carries a limited warranty against defective components and workmanship. The warranty excludes damage caused by acts of Nature such as lightning or flooding, power supply surges, rough handling, malicious actions or incorrect wiring.

Whilst every effort has been made to check that the information contained in this manual is accurate, JVA Technologies will not be liable to loss or damage resulting from construction, operation or failure of any installation or system.

Installation of security electric fences should be made by trained professionals regarding the relevant local standards and workplace health and safety requirements.

For details about the warranty period in your region, please see:

Australia – <https://www.jva-fence.com.au>

South Africa – <https://www.jvasecurity.co.za>

For any additional information, please contact the friendly sales team in your area for support.

Electric Fencing Products



DEALER



WWW.JVA-FENCE.COM