

# LEG STRAP

## PC-LS1-BLK | Quick Introduction

*For Use With Compatible PIVOT Mounting Solution Cases*

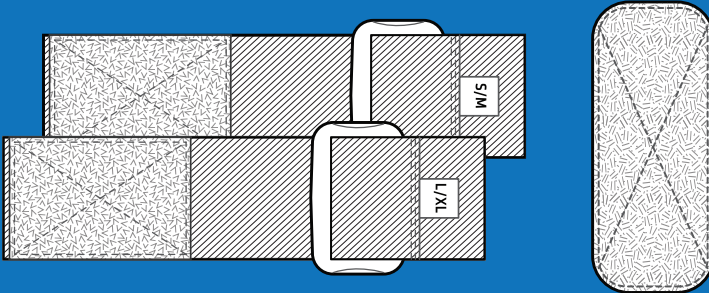
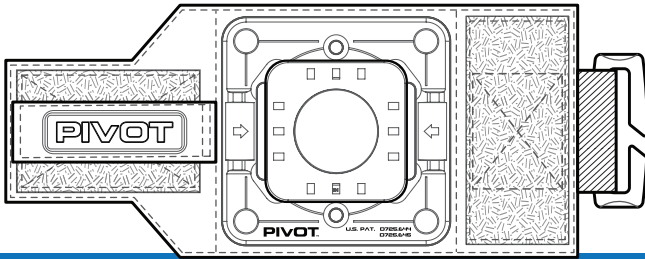

# PIVOT™

**Better Connection. Better Protection.**  
*Making the **Case** for Aviation.*

## PC-LS1-BLK | Quick Introduction

*For Use With Compatible PIVOT Cases*



### Read Before Use

*For optimal performance and maximum satisfaction with your PIVOT case and accessories, please follow this set of simple recommendations to ensure proper use and superior performance. Visit PIVOT online to learn more about your new product, including instructions for setup and other features.*

### **PC-LS1-BLK**

- ① 1pc Mounting Plate Pad
- ② 1pc Belt Tether
- ③ 1pc Wrist Stap Adaptor
- ④ 1pc S/M Leg Strap
- ⑤ 1pc L/XL Leg Strap

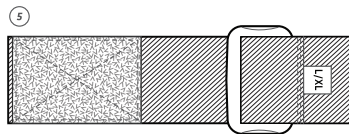
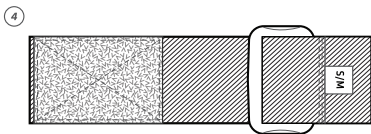
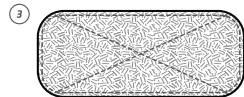
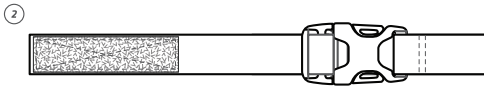
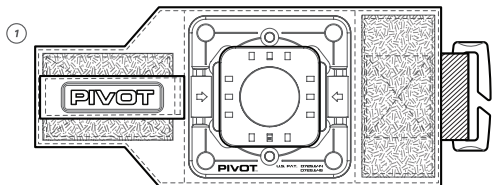

# Connection Point

Before getting started, it's important to identify the primary connection point of the main Mounting Plate Pad.

**A. PIVOT Mounting Plate** - Compatible with all PIVOT mounting cases.

**B. Strap Attachment Ring** - The Leg Straps attach to this plastic ring.

**C. Strap Closure Area** - Secure the straps by connections the adhesive hook/loop patches to this area.

**D. Lock Tab** - Lock the straps closed using this special tab.

**E. Accessory Area** - This patch of adhesive hook/loop is used to attach accessories such as the Belt Tether, Wrist Strap Adaptor or items sold separately such as pen loops, storage pouches r morale patches.

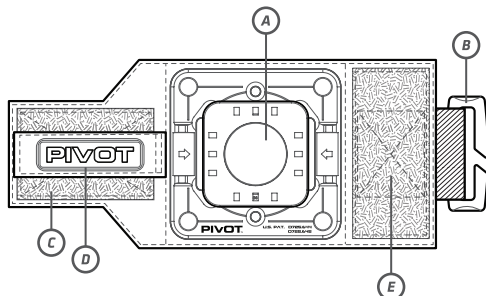

## ! Pro Tip!

The Leg Strap can be used in any left/right orientation. However, it's best to position the Accessory Area on the outer side of the user's thigh when attaching accessories, especially the Belt Tether.

# Getting Started

**STEP 1:** Begin by orienting the Leg Strap in your desired position. For first time users, feel free to match the illustration above atop the right leg with the elastic strap on the right. Please ensure the strap is attached as illustrated with the narrow hook/loop patch facing upward.

**STEP 2:** Lift the Lock Tab away from the Strap Closure area. Hold the Lock Tab open while positioning the Leg Strap assembly atop the thigh with the Mounting Plate Pad facing upward and toward the user.

**STEP 3:** While holding the assembly in place atop the thigh, wrap the elastic Leg Strap around the underside of the thigh and attach it to the Strap Closure Area. If the strap is too tight or loose, please adjust to a comfortable tension and try again. When the strap is securely attached, close the Lock Tab and press it firmly to lock the strap in place. Reverse this process to remove.

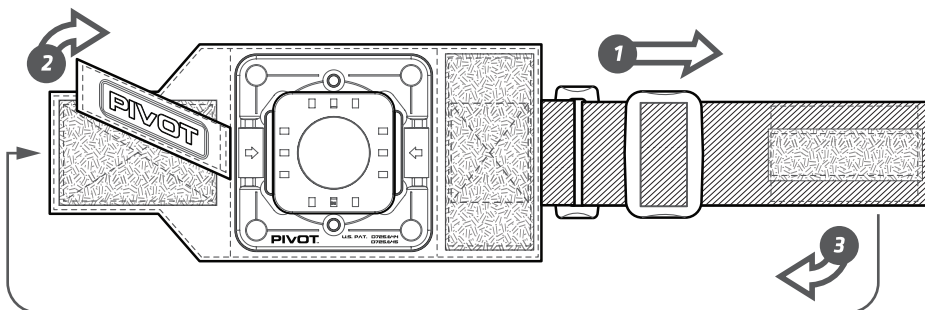

## Belt Tether + Adjustments

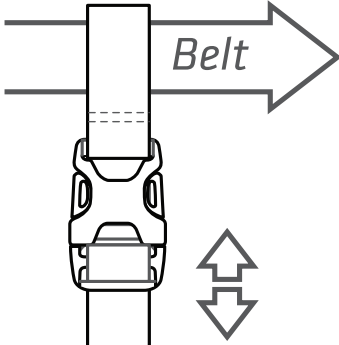

Use the Belt Tether to prevent the Leg Strap assembly from falling down the left is used while walking or standing.

**STEP 1:** Disengage the plastic Belt Tether buckle and loop the webbing around the belt or through a belt loop. Close the buckle. Then attach the Belt Tether to the Accessory Area via the adhesive hook/loop patch.

**STEP 2:** Adjust the fit of the Belt Tether and Leg Strap using the plastic hardware. For some users, adjustments may be easier before applying to leg.

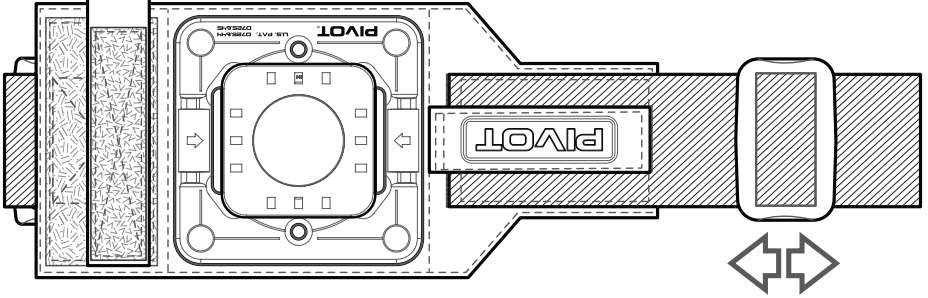

## Changing Leg Strap Sizes

The L/XL Les Strap is installed by default. Some users may prefer a tighter fit and will need to install the S/M Leg Strap instead. To do this, please follow the steps listed below:

**STEP 1:** Disengage the plastic Belt Tether buckle and loop the webbing around the belt or through a belt loop. Close the buckle. Then attach the Belt Tether to the Accessory Area via the adhesive hook/loop patch.

**STEP 2:** Adjust the fit of the Belt Tether and Leg Strap using the plastic hardware. For some users, adjustments may be easier before applying to leg.

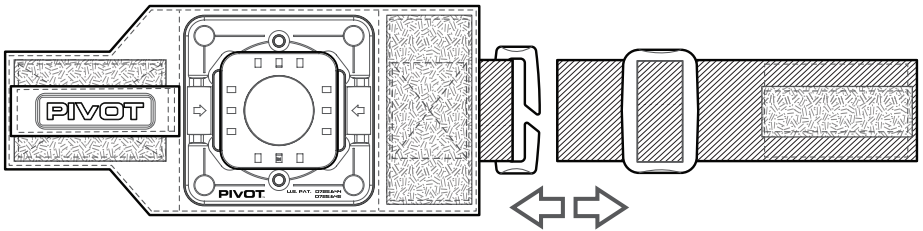

### **! Pro Tip!**

Is intended for use on rear facing cameras.

## PIVOT Mounting Solutions

The Leg Strap is compatible with all PIVOT mounting solution cases, which are sold separately. Connect your PIVOT case by sliding the Mounting Channel onto the Mounting Plate. The PIVOT Clip will engage and now the case is securely to the Leg Strap. Depress the PIVOT Clip and reverse this process to unmount the case.

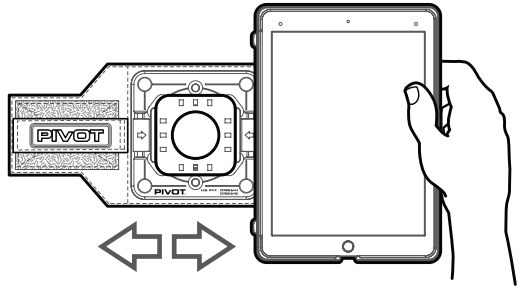

## Click! Connection



With PIVOT's audible engagement, be confident when hearing the "Click!" your connection is locked in place. If there is no "Click!" sound heard during your installation, you may have a misalignment and should reattempt.

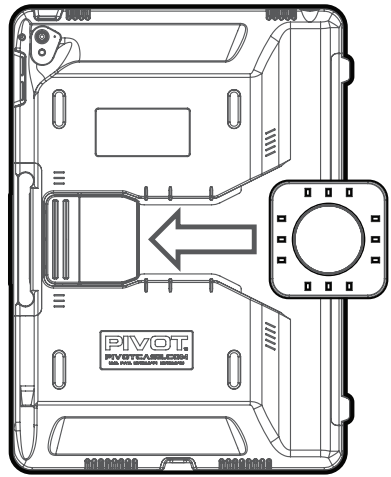

## Additional Information

To learn more about PIVOT cases, mounts and accessories, please visit [pivotcase.com](http://pivotcase.com) for instructional videos, product support and information about other PIVOT solutions. You'll find valuable online resources provided to enhance your user experience and see the complete line of PIVOT products.

# *Thank you.*

*Learn more at:*  
**PIVOTCASE.COM**

## *PIVOT SUPPORT*

*If you have questions please contact PIVOT Support.*

-  [www.pivotcase.com/support](http://www.pivotcase.com/support)
-  [sales@pivotcase.com](mailto:sales@pivotcase.com)
-  1-888-4-FLYBOYS (1-888-435-9269)
-  [www.youtube.com/c/pivotcasevideo](http://www.youtube.com/c/pivotcasevideo)



#EFBMADESIMPLE  
@PIVOTCASE

*TM and © 2020 FlyBoys. All rights reserved.  
Designed in USA. Printed in China.*

# **PIVOT™**

**Better Connection. Better Protection.**  
*Making the **Case** for Aviation.*