

Note!

Please note that this image is a general representation of the product and may differ slightly from your product.

Note!

Please note that during storage and transportation, especially at high ambient temperature, some of the oil and grease used for assembling may leak and stain the packaging. This is in no way detrimental to the product, wipe off the excessive oil/grease with a cloth.

Note!

Before installing this product, check the contents of the kit. If anything is missing, please check an Öhlins dealer.

Kit Contents

Description	Part No	Pcs
Shock absorber	TR 654	2
Washer 8.4/24/2	00426-03	4
Sticker set "ÖHLINS"	10207-01	1
Tool preload adjuster	03199-03	1
Owners manual	07241-02	1

Warning!

Before installing this product, read the Öhlins Owner's Manual. The shock absorber is an important part of your vehicle and will affect the stability.

Shock Absorber for Triumph Bonneville T100/T120

TR 654

Mounting Instructions



MOUNTING INSTRUCTIONS

Warning!

It is advisable to have an Öhlins dealer install the shock absorber.

Warning!

If working on a raised vehicle, ensure it is securely supported so that it will not tip over.

Note!

Before mounting this product clean the vehicle thoroughly.

Note!

When working on this product, always see the Vehicle Service Manual for vehicle specific procedures and important data.

Note!

Lower the vehicle so that the suspension is slightly compressed before tightening the screws.

Caution!

Ensure that all screws are tightened to the correct torque and that nothing fouls or restricts movement of the shock absorber when the suspension is fully compressed or extended.

1
Put the motorcycle on a work stand so that the rear wheel barely touches the ground.

2
Remove the standard shock absorber by loosening the top and bottom mounting bolts (1) (2)

3
Install the Öhlins shock absorber as per picture 3.1 (for both top and bottom mounting points) and tighten at a torque value as specified in the vehicle service manual.

MOUNTING INSTRUCTIONS

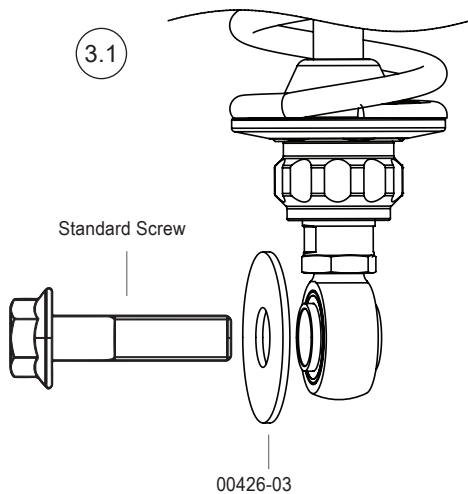
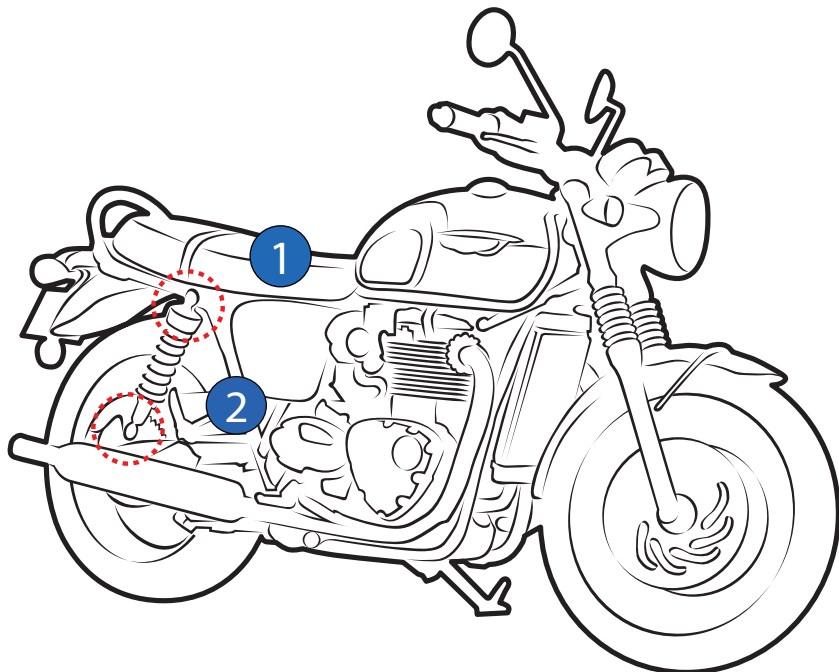

ADJUSTMENTS

⚠ Warning!

Before riding, always make sure that the basic settings made by Öhlins are according to recommended Set-up Data. Read about adjustments and setting up in the Öhlins Owner's Manual before you make any adjustments. Contact an Öhlins dealer if you have any questions about setting up.

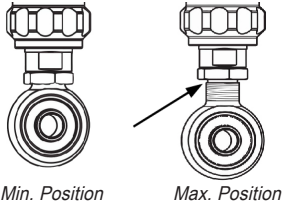

⚠ Warning!

The adjustable end eye/bracket must not be threaded out more than that the groove is fully visible beneath the lock nut. This is maximum length. After adjusting, make sure that the lock nut is tightened (30Nm).

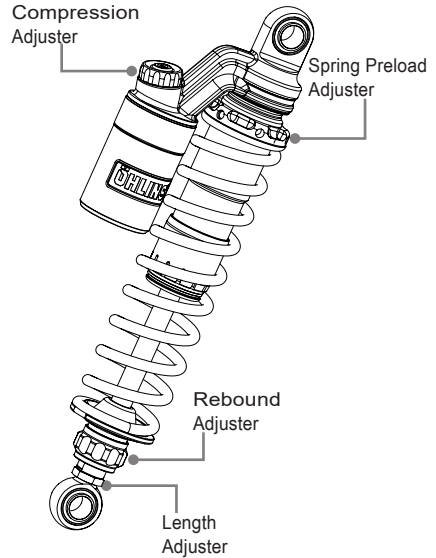

SET-UP DATA

Recommended set-up

Spring Preload.....	14 mm.
Rebound adjuster	23 Clicks
Compression adjuster.....	15 Clicks

Spring

Part No	60480-02
Free spring length.....	230 mm.
Spring rate.....	Progressive 16-26 N/mm
Preload adj.range.....	[0-32] mm

Shock absorber data

Length	348 ⁺¹⁰ / ₀ mm.
Stroke	98 mm.

👁 Öhlins products are subject to continuous improvement and development, therefore, although these instructions include the most up-to-date information available at the time of printing, minor updates may occur.

To find the latest information contact an Öhlins distributor. Please contact Öhlins if you have any questions regarding the contents in this document.

Part no. MI_TR654_EN_0
Issued 2022-10-19

© Öhlins Asia Co. Ltd. All rights reserved. Any reprinting or unauthorized use without the written permission of Öhlins Racing AB is prohibited.

Öhlins Asia Co. Ltd
700/937 Moo5, Tambol Nongkhaga,
Amphur Phantong, Chonburi Province
20160 Thailand



www.ohlins.com