

### 👁️ **Note!**

Before installing this product, check the contents of the kit.  
If anything is missing, please contact an Öhlins dealer

### Kit Contents

Description	Part No	Pcs
Shock absorber	HO 213	1
Bracket reservoir 44	03102-15	1
Bracket, Reservoir	60006-32	1
Screw M6x14	00382-16	1
Screw M6x12	05404-01	2
Tie-rap	60231-01	1
C-spanner S46	60710-02	1
Sticker R&T "ÖHLINS"	10207-01	1
Owners manual MX-Enduro	07251-02	1

### Index

Instruction	Page
Disassembly-300Rally	2-5
Disassembly-300L	6
Installation ÖHLINS Shock absorber	7-10

### 👁️ **Note!**

Please note that this image is a general representation of the product and may differ slightly from your product.

### 👁️ **Note!**

Please note that during storage and transportation, especially at high ambient temperature, some of the oil and grease used for assembling may leak and stain the packaging. This is in no way detrimental to the product, wipe off the excessive oil/grease with a cloth.

### ⚠️ **Warning!**

Before installing this product, read the Öhlins Owner's Manual. The shock absorber is an important part of your vehicle and will affect the stability.

## Shock Absorber for Honda CRF300L(EU) CRF300Rally(Asia/EU)

# HO 213

## Mounting Instructions



# HONDA CRF300RALLY

## **Warning!**

*It is advisable to have an Öhlins dealer install the shock absorber.*

## **Warning!**

*If working on a raised vehicle, ensure it is securely supported so that it will not tip over.*

## **Note!**

*Before mounting this product clean the vehicle thoroughly.*

## **Note!**

*When working on this product, always see the Vehicle Service Manual for vehicle specific procedures and important data.*

## 1-6 : DISASSEMBLY PROCEDURE SHOCK ABSORBER-300RALLY

## **Note!**

*Remove the engine guard before put the motorcycle on a work stand.*

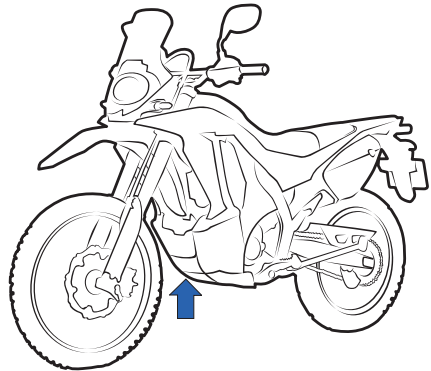

1. Remove the engine front guard by removing the screws ① ② ③ ④

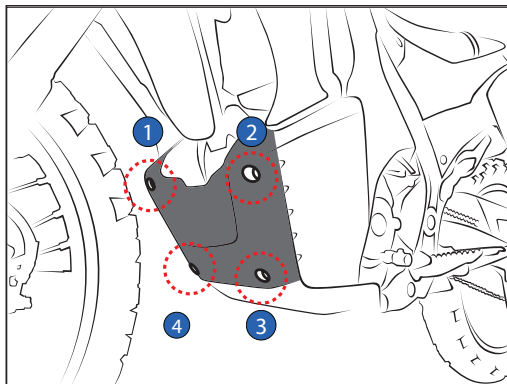
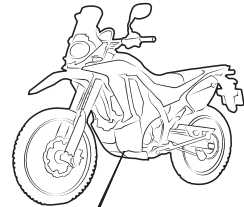

# HONDA CRF300RALLY

2.

Remove the engine bottom guard by removing the screws ① ②

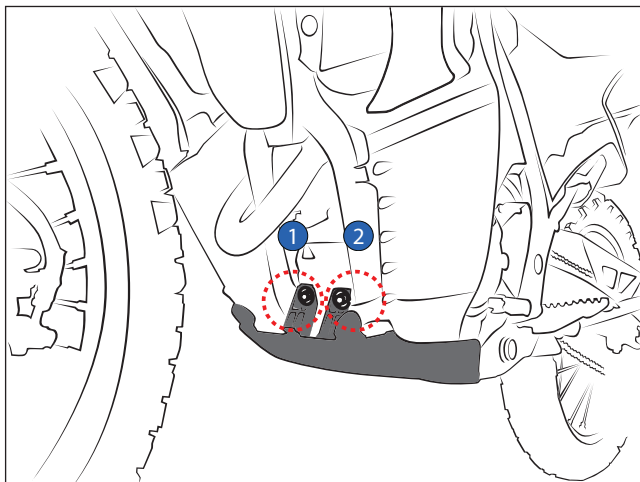
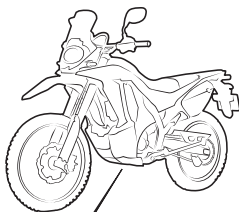

3.

Put the motorcycle on a work stand so that the rear wheel barely touches the ground. Make sure the motorcycle is in a stable position.

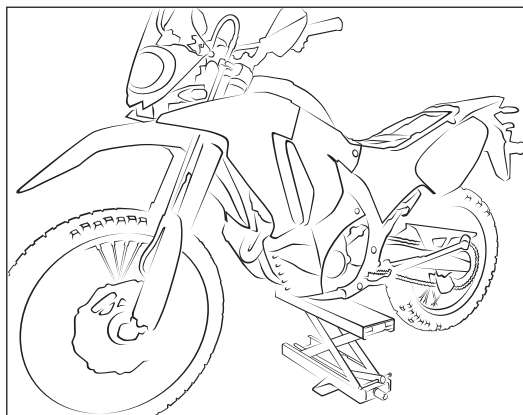

# HONDA CRF300RALLY

4.

Remove the seat by removing the bolts ① ②

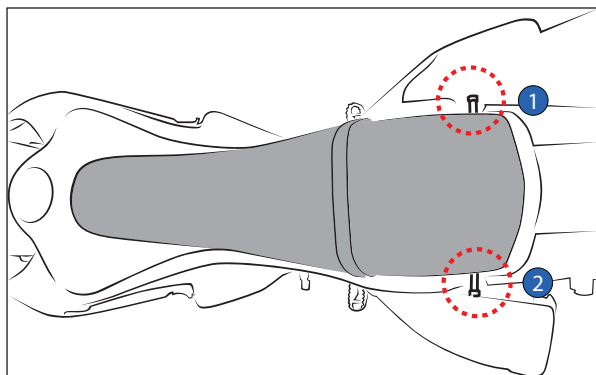

5.

**On LH side and RH side :**

Remove the fairings by loosening the screws

① ② ③ ④ ⑤ ⑥

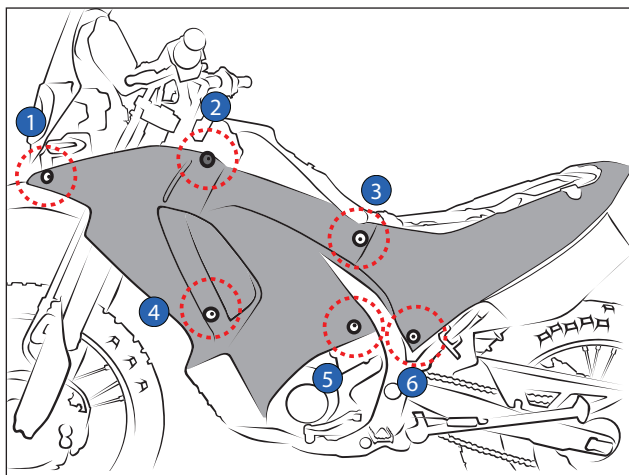

# HONDA CRF300RALLY

6.

Remove the standard shock absorber by loosening the upper mounting bolt ① and the lower mounting bolts ② and ③ from the linkage.

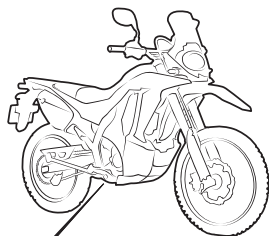
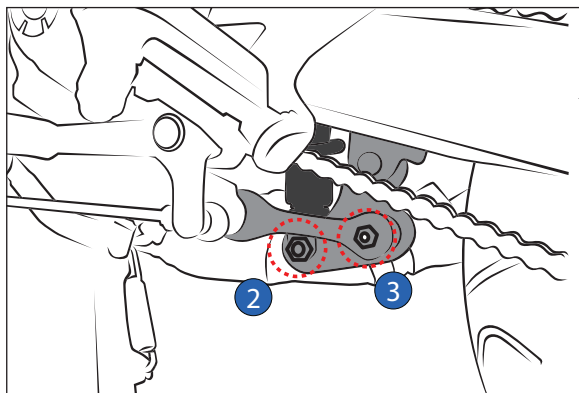
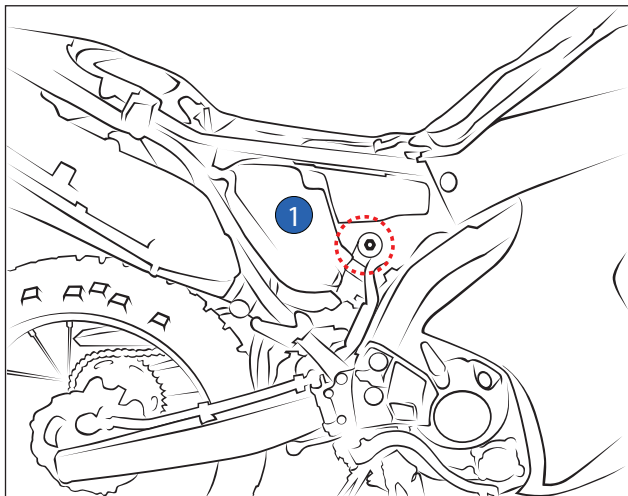

# HONDA CRF300L

## 7-8 : DISASSEMBLY PROCEDURE SHOCK ABSORBER-300L

7

Put the motorcycle on a work stand so that the rear wheel barely touches the ground.

Make sure the motorcycle is in a stable position.

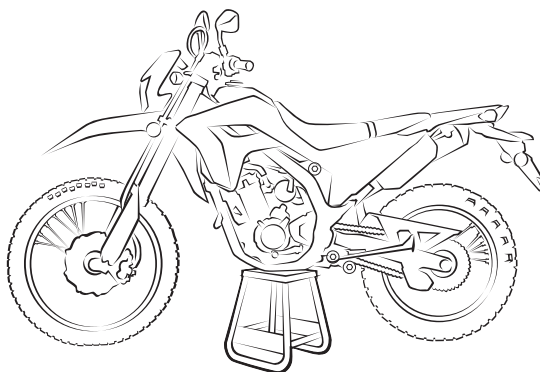

8.

Remove the standard shock absorber by loosening the upper mounting bolt ① and the lower mounting bolts ② and ③ from the

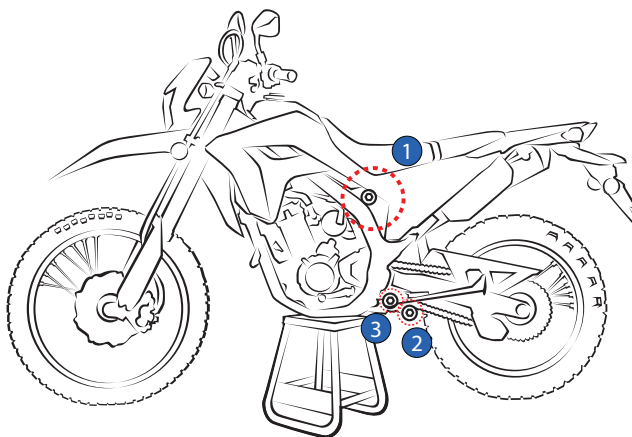

# MOUNTING INSTRUCTIONS

## 9- 13 : INSTALLATIONS ÖHLINS SHOCK ABSORBER-300RALLY/300L

9.

In order to route the reservoir to the left side of the motorcycle.

Proceed as per following instructions:

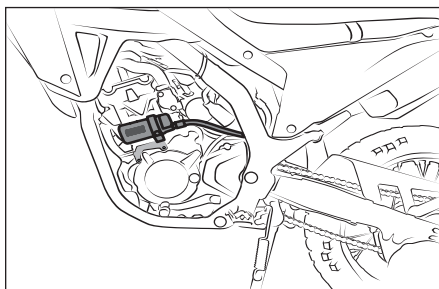

### On the right side

9.1

Remove the plastic cover by loosening the screw ①.

Loosen the nut ② located underneath the cover

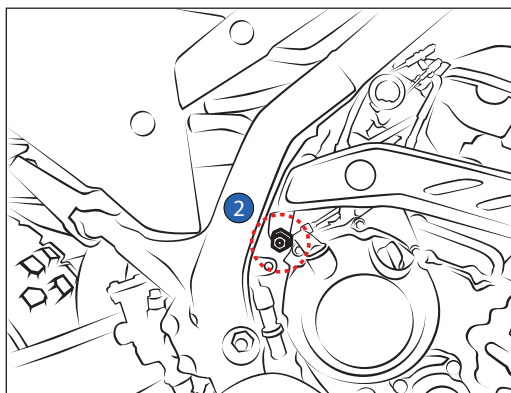
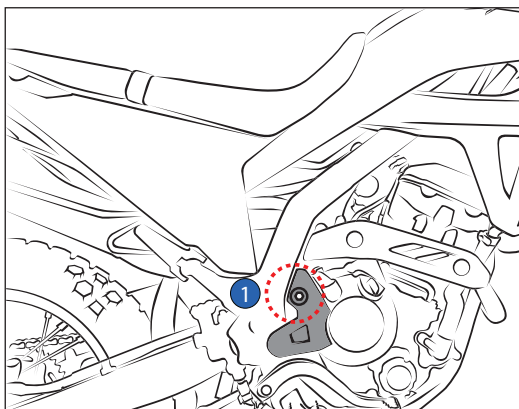

# MOUNTING INSTRUCTIONS

## On the left side

9.2

Remove the sprocket cover by loosening the screws ① ②

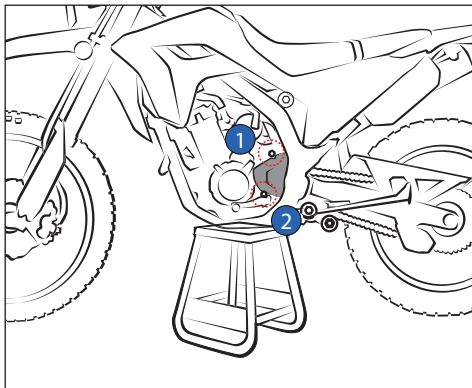

9.3

Remove the evap canister bracket by loosening the screws ① ② ③ ④

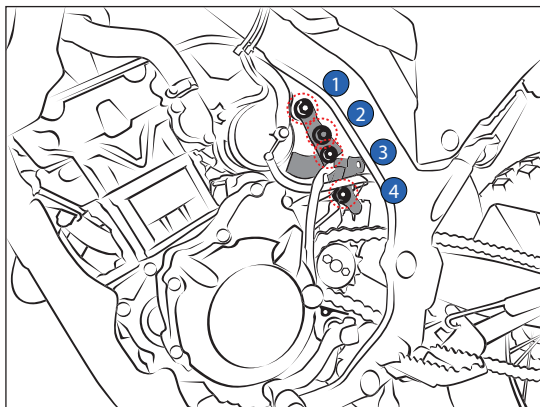



# MOUNTING INSTRUCTIONS

10.

Install the Öhlins shock absorber with the hose pointing to the left side of the motorcycle.

Tighten the upper ① and the lower mounting bolts ② and ③ at a torque value as specified in the vehicle service manual.

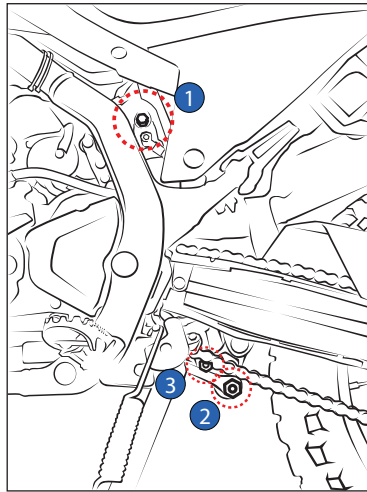

## **Note!**

*Lower the vehicle so that the suspension is slightly compressed before tightening the screws.*

## **Caution!**

*Ensure that all screws are tightened to the correct torque and that nothing fouls or restricts movement of the shock absorber when the suspension is fully compressed or extended.*

# MOUNTING INSTRUCTIONS

11.

Rout the reservoir to the left side of the motorcycle as per diagram P1

12.

Adjust the reservoir and hose position so that the hose is not touching any motorcycle parts.

13.

Reverse all procedures as necessary

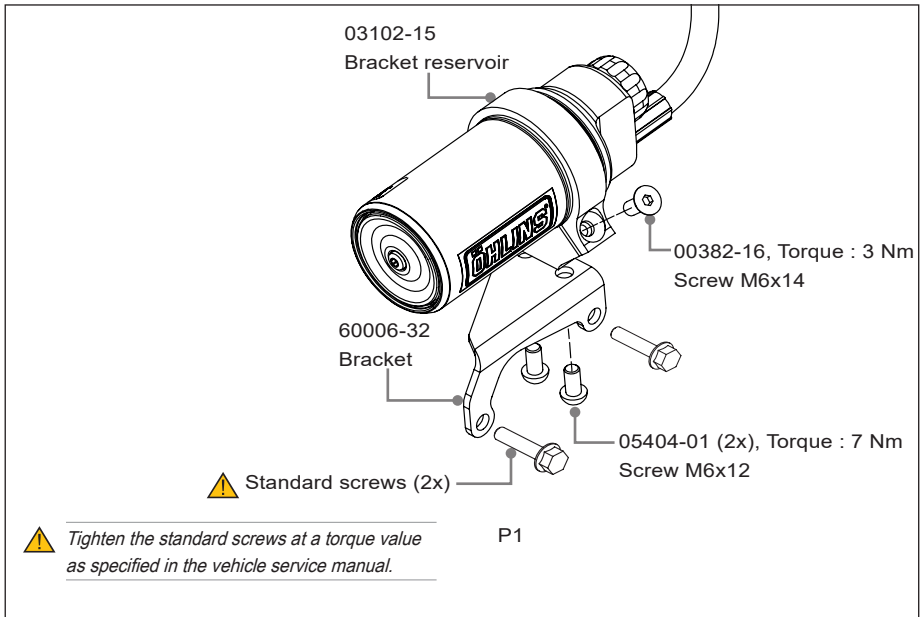
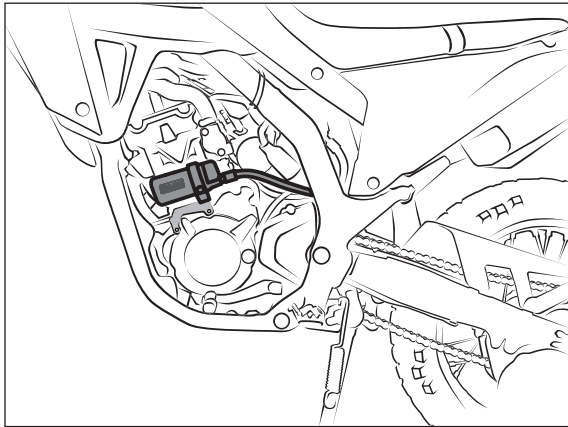

This page intentionally left blank

# ADJUSTMENTS

## ⚠ Warning!

Before riding, always make sure that the basic settings made by Öhlins are according to recommended Set-up Data. Read about adjustments and setting up in the Öhlins Owner's Manual before you make any adjustments. Contact an Öhlins dealer if you have any questions about setting up.

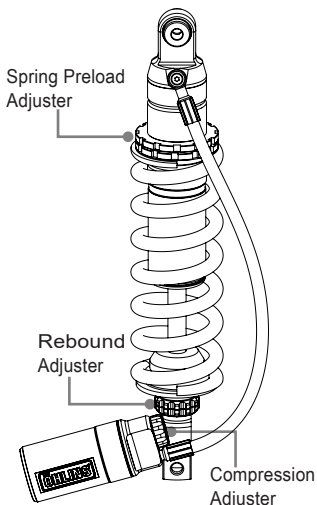

# SET-UP DATA

## Recommended set-up

Spring Preload ..... 10 mm  
Rebound adjuster ..... 14 Clicks  
Compression adjuster. 16 Clicks

## Spring

Part No ..... 60011-31  
Free spring length ..... 230 mm  
Spring rate..... 95 N/mm  
Preload adj.range..... [0-19] mm

## Shock absorber data

Length ..... 413.5mm  
Stroke ..... 94 mm

👁 Öhlins products are subject to continuous improvement and development, therefore, although these instructions include the most up-to-date information available at the time of printing, minor updates may occur.

To find the latest information contact an Öhlins distributor. Please contact Öhlins if you have any questions regarding the contents in this document.

Part no. MI\_HO 213 EN\_0  
Issued 2022-05-25

© Öhlins Asia Co. Ltd. All rights reserved. Any reprinting or unauthorized use without the written permission of Öhlins Racing AB is prohibited.

Öhlins Asia Co. Ltd  
700/937 Moo5, Tambol Nongkhaga,  
Amphur Phantong, Chonburi Province  
20160 Thailand



[www.ohlins.com](http://www.ohlins.com)