

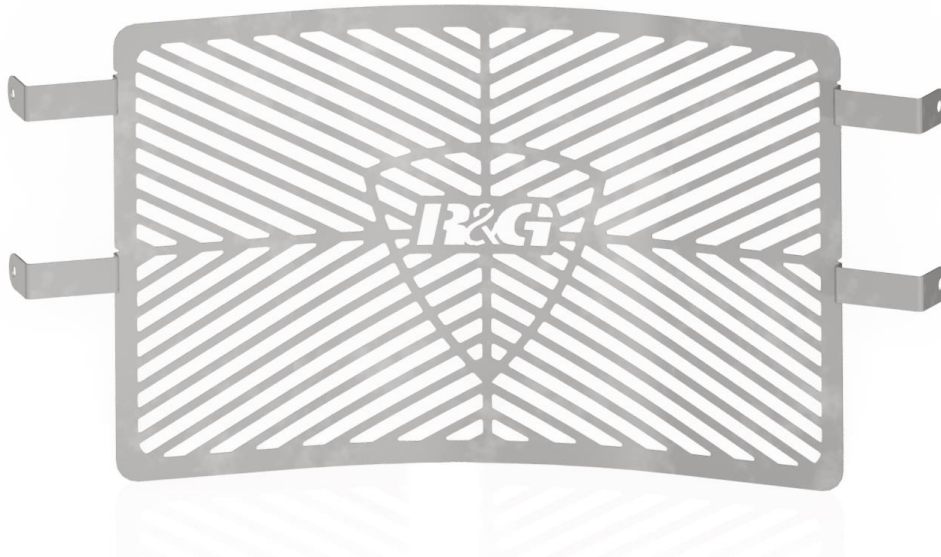

FITTING INSTRUCTIONS FOR BRG0015SS BRANDED RADIATOR GUARD
DUCATI HYPERMOTARD 950 2019-, MONSTER 1200 + 821 2014-,
SUPERSPORT 2017, SUPERSPORT 950 + S 2021-, DIAVEL 1260S 2019-2020



THIS KIT CONTAINS THE ITEMS PICTURED AND LABELLED OVER PAGE.
SOME PARTS MAY BE SHOWN FOR CLARITY OF INSTRUCTIONS ONLY.

DO NOT PROCEED UNTIL YOU ARE SURE ALL PARTS ARE PRESENT.

PLEASE READ ALL INSTRUCTIONS BEFORE PROCEEDING.

**IF IN ANY DOUBT WHEN FITTING OUR PRODUCTS, CONSULT ONE OF OUR DEALERS
OR HAVE FITTED BY A QUALIFIED TECHNICIAN.**

PLEASE NOTE THAT THE WAY THE KIT IS PACKED DOES NOT NECESSARILY REPRESENT THE WAY OF
MOUNTING TO THE BIKE.

IN THE EVENT OF RUBBER WASHERS BEING USED TO HOLD COMPONENTS ONTO BOLTS,
THESE RUBBER WASHERS CAN BE THROWN AWAY.

DIGITAL COPIES OF THESE INSTRUCTIONS ARE AVAILABLE FROM:

WWW.RG-RACING.COM



<u>TOOLS REQUIRED</u>	<u>GENERAL TORQUE SETTINGS</u>
<ul style="list-style-type: none"> • Socket set to include 4mm and 8mm A/F socket & wrench • Set of metric Allen keys to include 3mm – 8mm • Cable cutters 	<p>M4 BOLT = 8Nm</p> <p>M5 BOLT = 12Nm</p> <p>M6 BOLT = 15Nm</p> <p>M8 BOLT = 20Nm</p> <p>M10 BOLT = 40Nm</p> <p>M12 BOLT = 40Nm</p>

LEGEND

ITEM NO.	DESCRIPTION	QTY
ITEM 1	BRG0015SSCOMP BRANDED RADIATOR GUARD	1
ITEM 2	CT220 220mm LONG CABLE TIES	8
ITEM 3	100mm LENGTH OF SELF-ADHESIVE FOAM	2
ITEM 4	M5 x 12mm LONG BUTTON HEAD BOLTS	2
ITEM 5	M5 PENNY WASHERS	2

FITTING PICTURES



Picture 1



Picture 2

R&G Racing

Unit 1, Shelley's Lane, East Worldham, Alton, Hampshire, GU34 3AQ

Tel: +44 (0)1420 89007 Fax: +44 (0)1420 87301 www.rg-racing.com Email: info@rg-racing.com



Picture 3



Picture 4



Picture 5



Picture 6



Picture 7

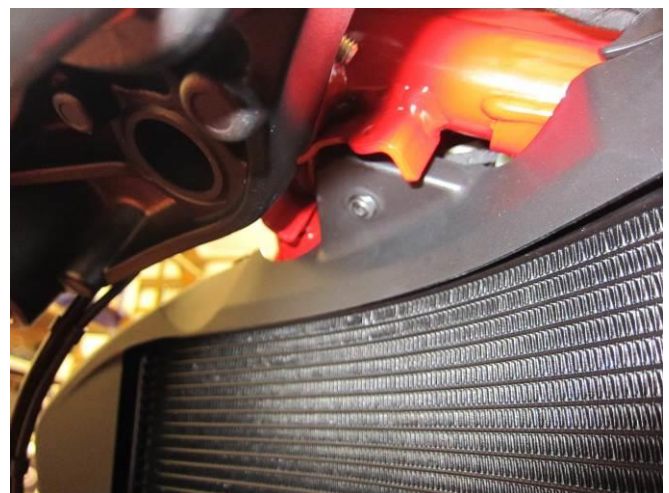

Picture 8



Picture 9



Picture 10



Picture 11

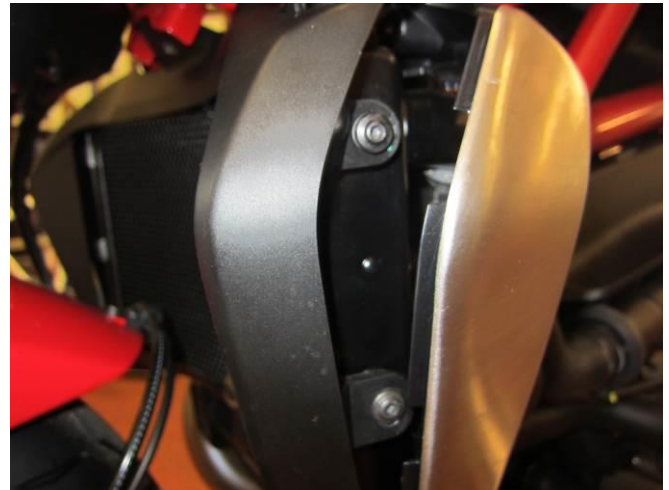

Picture 12



Picture 13



Picture 14



Picture 15

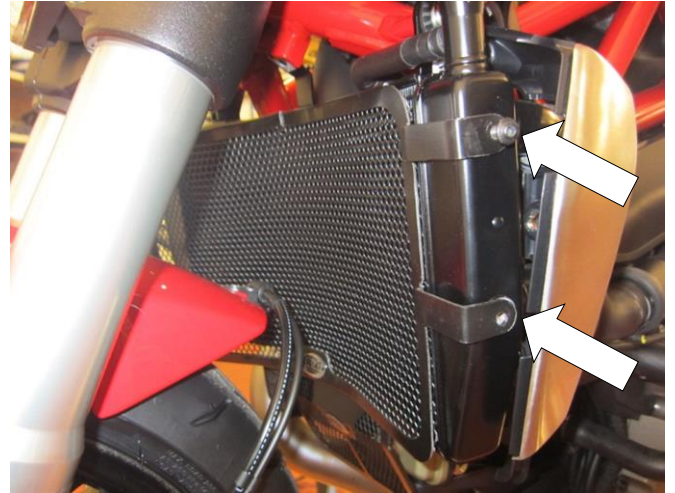

Picture 16



Picture 17

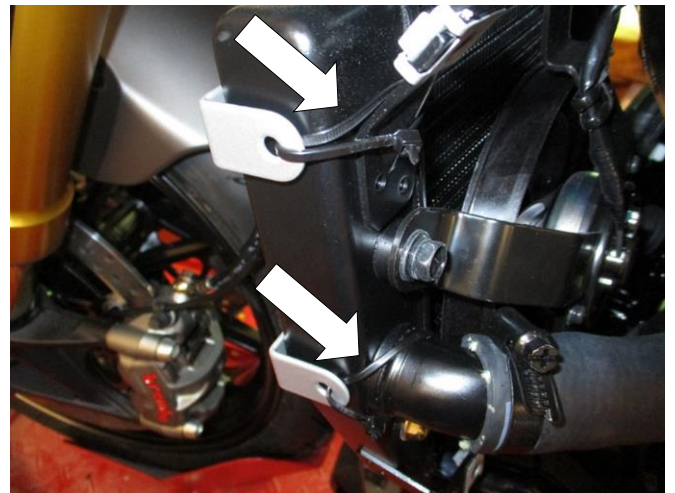

Picture 18



Picture 19



Picture 20

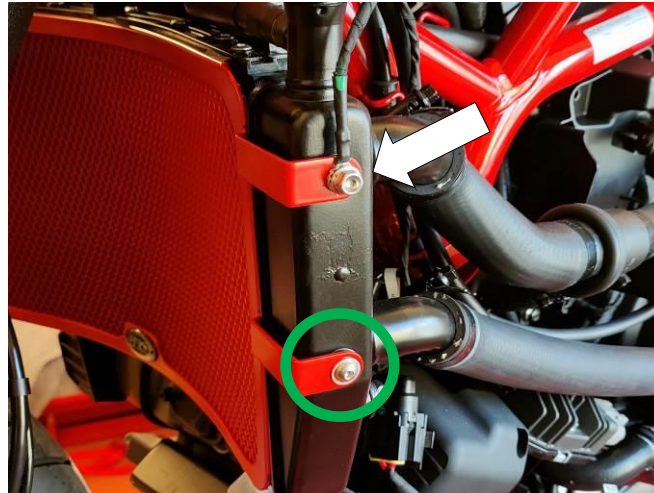

Picture 21

FITTING INSTRUCTIONS

If fitting to the Ducati Hypermotard 950 2019-, Monster 1200 + 821 2014-, Supersport 2017-

- To fit the radiator guard to the bike cut the foam strip provided into 10mm wide pieces and stick them to the back of the radiator guard frame, so that they sit between the radiator guard and the radiator.
- Remove the three 4mm A/F bolts on the right side of the bike that secure the plastic cowl in place on the back of the radiator, as shown in **(picture 1)**.
- Remove the plastic cowl from the radiator, as shown in **(picture 2)**.
- On the left side of the bike, remove the radiator cap and pull the rubber cover over the neck of the radiator filler, as shown in **(pictures 3 & 4)**.
- Remove the three 4mm A/F bolts that secure the plastic cowl in place on the back of the radiator, as shown in **(picture 5)**.
- This plastic cowl cannot be fully removed from the bike, just pulled clear to gain access to the two side bolts on the radiator, as shown in **(picture 6)**.
- Remove the two bolts on both sides of the radiator that secure the plastic radiator surround to the radiator, as shown in **(pictures 6 & 7)**.
- Remove the remaining bolt that secures the plastic radiator surround in place that is located under the headstock, as shown in **(picture 8)**, before removing the plastic surround from the bike.
- Offer the R&G Radiator Guard roughly into place and locate one of the OEM bolts through a mounting hole on the left side of the bike and tighten a few turns in the side of the radiator as shown in **(picture 9)**. *This is to hold the radiator guard loosely in place whilst fitting the plastic surround onto the other side of the bike.*

R&G Racing

Unit 1, Shelley's Lane, East Worldham, Alton, Hampshire, GU34 3AQ

Tel: +44 (0)1420 89007 Fax: +44 (0)1420 87301 www.rg-racing.com Email: info@rg-racing.com



- On the right side of the bike, the radiator guard mounts should align roughly with the mounting holes on the side of the radiator. Offer the plastic radiator surround back into position ensuring the side mounts sit over the top of the radiator guard mounts, before refitting the OEM bolts through the plastic surround, then through the radiator guard mounts and tighten into the radiator, as shown in **(pictures 10 & 11)**.
- On the left side of the bike, remove the previously fitted loose bolt, allow the plastic surround to sit back against the radiator, ensure all the holes align and re-fit the two OEM bolts through the radiator surround, then through the radiator guard and tighten into the side of the radiator, as shown in **(picture 12)**.
- Re-fit the OEM bolt that secures the centre of the radiator guard in place under the headstock, before checking the radiator guard and surround are correctly mounted and tighten all five bolts.
- Re-fit the radiator plastic cowls on both sides of the bike and tighten the three bolts on both sides.
- Re-fit the rubber cover onto the radiator filler neck before re-fitting the radiator filler cap.

If fitting to the Ducati Supersport 950 + S 2021- (item 4 and 5 required)

- The radiator surrounds or fairing will need to be removed to access the radiator mount holes on either side of the radiator as shown in **(picture 15)**.
- To remove the fairing and radiator surround,
- Remove the 1 x bolt from the right-hand side of the radiator as arrowed in **(picture 19)**.
- Loosen off 1 x bolt as arrowed in **(picture 20)** to allow the horn mount to pivot.
- Remove the 1 x bolt from the left-hand side of the radiator as arrowed in **(picture 21)**.
- Offer the radiator guard up to the radiator and align the mounting holes with the bolt holes.
- Replace the OEM bolts along with the provided 2 x bolts and washers **(items 4 and 5)** into the 2 lower mounting points on both sides of the radiator as circled in **(pictures 20 and 21)**.
- Make sure the retaining bolts are fully tightened before reassembling any radiator surrounds or fairing.
- Check the tightness of all bolts and that all panels are secure before riding.

If fitting to the Ducati Diavel 1260S 2019-2020

- Remove the indicator side panels as per previous instructions, cutting the cable ties tidying the indicator wiring in order to free the panels, as shown in **(picture 13)**.
- Secure the radiator guard to the radiator using 4 of the included cable ties, as shown in **(picture 14)**.
- Refit the side panels and re-tidy the indicator wiring using the 4 remaining cable ties.
- Check the tightness of all bolts and that all panels are secure before riding.

R&G Racing

Unit 1, Shelley's Lane, East Worldham, Alton, Hampshire, GU34 3AQ

Tel: +44 (0)1420 89007 Fax: +44 (0)1420 87301 www.rg-racing.com Email: info@rg-racing.com



ISSUE 1 – 12/10/2021 (AO)

CONSUMER NOTICE

The catalogue description and any exhibition of samples are only broad indications of the Products and R&G may make design changes which do not diminish their performance or visual appeal and supplying them in such state shall conform to the order. The Buyer acknowledges no representation or warranty (other than as to title) has been given or will apply to the Products other than those in R&G's order or confirmation and the Buyer confirms it has chosen the Products as being of merchantable quality and suitable for its particular purposes. Where R&G fits the Products or undertakes other services it shall exercise reasonable skill and care and rectify any fault free of charge unless the workmanship has been disturbed. The Buyer is responsible for ensuring that the warranty on the motorcycle is not affected by the fitting of the Products. On return of any defective Products R&G shall at its option either supply a replacement or refund the purchase money but shall not be liable if the Products have been modified or used or maintained otherwise than in accordance with R&G's or manufacturer's instructions and good engineering practice or if the defect arises from accident or neglect. Other than identified above and subject to R&G not limiting its liability for causing death and personal injury, it shall not be liable for indirect or consequential loss and otherwise its liability shall be limited to the amounts paid by the Buyer for the Products or the fitting or service concerned. These terms do not affect the Buyer's statutory rights.

R&G RACING RETURNS POLICY (NON-FAULTY GOODS)

Returns must be pre-authorized (if not pre-authorized the return will be rejected). Goods may only be returned direct to us if they were purchased direct from us (customer must prove if necessary). Otherwise to be returned to original vendor. Goods must be in re-sellable condition, in the opinion of R&G Racing. All returns are subject to a 25% restocking and handling fee (25% of the gross value exc. P&P – at the prevailing price at time of purchase). The customer must pay any and all carriage charges. No returns of discontinued products, unless within 14 days of purchase. This policy does not affect your statutory rights and does not refer to faulty goods.

R&G Racing

Unit 1, Shelley's Lane, East Worldham, Alton, Hampshire, GU34 3AQ

Tel: +44 (0)1420 89007 Fax: +44 (0)1420 87301 www.rg-racing.com Email: info@rg-racing.com



**NOTICE DE MONTAGE BRG0015SS GRILLE DE PROTECTION RADIATEUR
DUCATI HYPERMOTARD 950 2019-, MONSTER 1200 + 821 2014-,
SUPERSPORT 2017, SUPERSPORT 950 + S 2021-, DIAVEL 1260S 2019-2020**

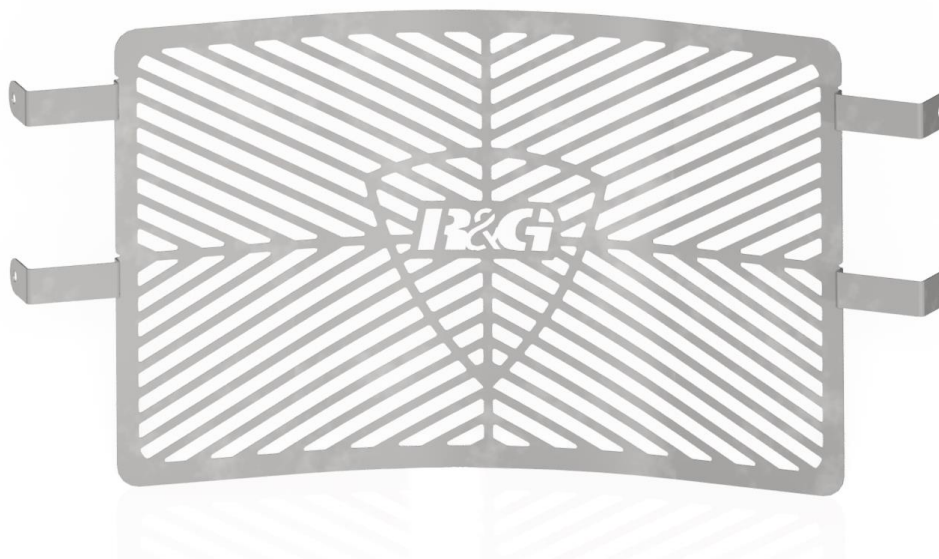

CE KIT CONTIENT LES ARTICLES ILLUSTRÉS ET ÉTIQUETES SUR LA PAGE.

CERTAINES PARTIES PEUVENT ÊTRE PRÉSENTES UNIQUEMENT POUR LA CLARTÉ DES INSTRUCTIONS.

NE PAS PROCÉDER AU MONTAGE TANT QUE VOUS N'ÊTES PAS SÛR QUE TOUTES LES PIÈCES SOIENT PRÉSENTES.

VEUILLEZ LIRE TOUTES LES INSTRUCTIONS AVANT DE CONTINUER.

EN CAS DE DOUTE LORS DU MONTAGE DE NOS PRODUITS, CONSULTEZ UN DE NOS REVENDEURS OU FAITES APPEL À UN TECHNICIEN QUALIFIÉ.

VEUILLEZ NOTER QUE LA FAÇON DONT LE KIT EST EMBALLÉ NE REPRÉSENTE PAS NECESSAIREMENT LA MANIÈRE DE LE MONTER SUR LA MOTO.

SI DES RONDELLES EN CAOUTCHOUC SONT UTILISÉES POUR MAINTENIR LES COMPOSANTS SUR LES BOULONS, ELLES PEUVENT ÊTRE JETÉES.

NOTICE DISPONIBLE AU TÉLÉCHARGEMENT SUR :

WWW.RG-RACING.COM

R&G Racing

Unit 1, Shelley's Lane, East Worldham, Alton, Hampshire, GU34 3AQ

Tel: +44 (0)1420 89007 Fax: +44 (0)1420 87301 www.rg-racing.com Email: info@rg-racing.com



<u>OUTILS REQUIS</u>	<u>VALEURS DE SERRAGE</u>
<ul style="list-style-type: none"> • Clé à cliquet + douilles 4mm et 8mm • Clés Allen 3mm – 8mm • Pince coupante 	M4 BOULON = 8Nm M5 BOULON = 12Nm M6 BOULON = 15Nm M8 BOULON = 20Nm M10 BOULON = 40Nm M12 BOULON = 40Nm

LÉGENDE

ARTICLE NO.	DESCRIPTION	QTÉ
ARTICLE 1	RAD0172 GRILLE DE PROTECTION RADIATEUR	1
ARTICLE 2	CT220 220mm COLLIERS DE SERRAGE	8
ARTICLE 3	100mm BANDEAU DE MOUSSE AUTOCOLLANT	2
ARTICLE 4	M5 x 12mm BOULONS	2
ARTICLE 5	M5 RONDELLES	2

FITTING PHOTOS



Photo 1



Photo 2

R&G Racing

Unit 1, Shelley's Lane, East Worldham, Alton, Hampshire, GU34 3AQ

Tel: +44 (0)1420 89007 Fax: +44 (0)1420 87301 www.rg-racing.com Email: info@rg-racing.com



Photo 3



Photo 4



Photo 5



Photo 6



Photo 7

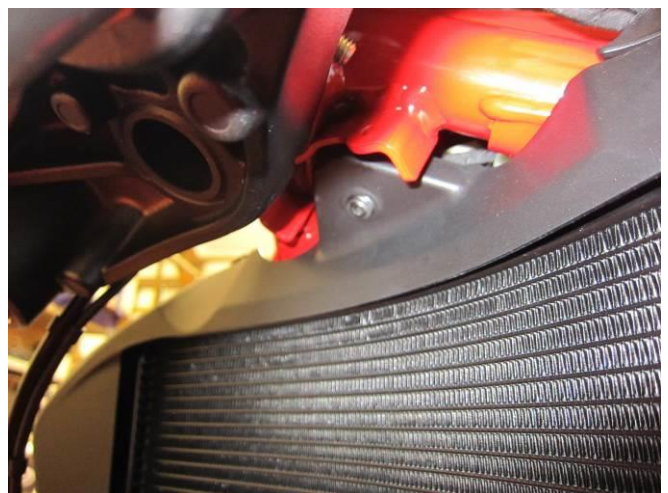

Photo 8



Photo 9



Photo 10



Photo 11



Photo 12



Photo 13



Photo 14



Photo 15

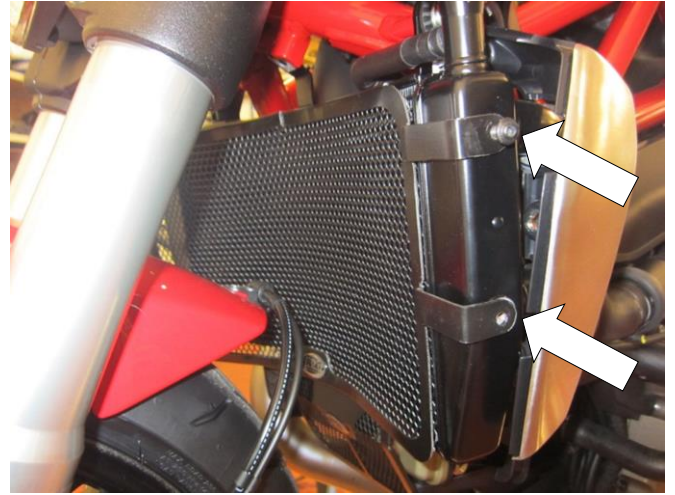

Photo 16

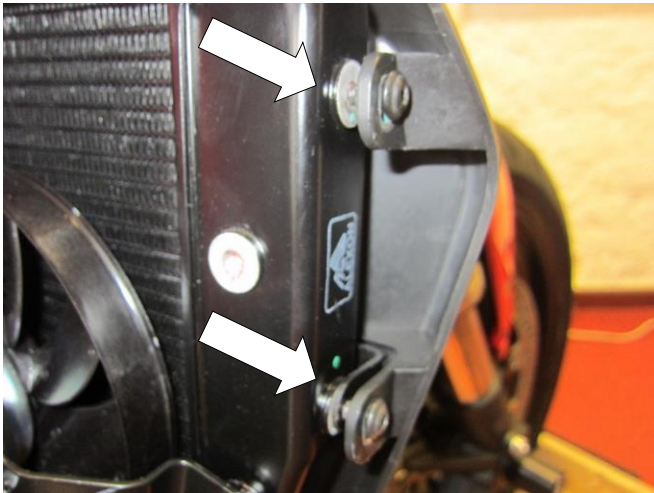

Photo 17



Photo 18



Photo 19

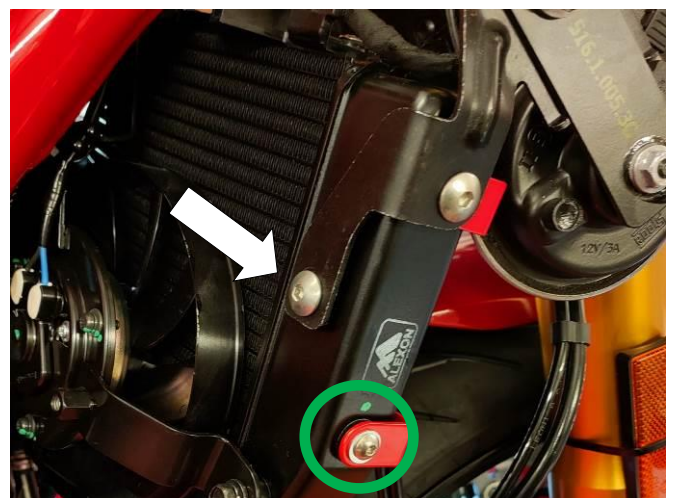

Photo 20

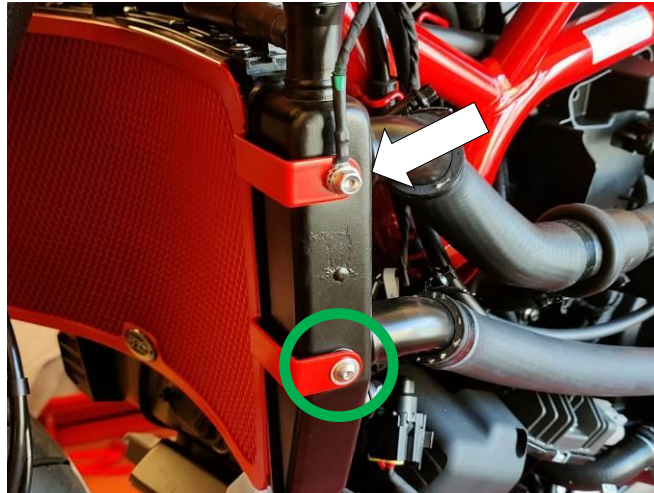

Photo 21

NOTICE DE MONTAGE

S'adapte à la Ducati Hypermotard 950 2019-, Monster 1200 + 821 2014-, Supersport 2017--

- Pour installer la protection radiateur sur la moto, coupez la bande de mousse fournie en morceaux de 10 mm de large et collez-les à l'arrière du cadre de la protection du radiateur, de sorte qu'ils reposent entre la protection radiateur et le radiateur.
- Retirez les trois boulons A / F de 4 mm sur le côté droit de la moto qui maintiennent le capot en plastique en place à l'arrière du radiateur, comme illustré sur la (photo 1).
- Retirez le capot en plastique du radiateur, comme indiqué sur la (photo 2).
- Du côté gauche de la moto, retirez le bouchon du radiateur et tirez le couvercle en caoutchouc sur le col du remplisseur de radiateur, comme indiqué sur les (photos 3 et 4).
- Retirez les trois boulons A / F de 4 mm qui maintiennent le capot en plastique en place à l'arrière du radiateur, comme indiqué sur la (photo 5).
- Ce capot en plastique ne peut pas être complètement retiré de la moto, il suffit de le tirer pour accéder aux deux boulons latéraux du radiateur, comme indiqué sur la (photo 6).
- Retirez les deux boulons des deux côtés du radiateur qui fixent le contour en plastique du radiateur au radiateur, comme illustré sur (photos 6 et 7).
- Retirez le boulon restant qui maintient le contour du radiateur en plastique en place qui est situé sous la poupée, comme indiqué sur (photo 8), avant de retirer le contour en plastique de la moto.
- Mettez en place la protection radiateur R&G et placez l'un des boulons d'origine à travers un trou de montage sur le côté gauche de la moto et serrez de quelques tours sur le côté du radiateur comme indiqué sur (photo 9). Ceci permet de maintenir la protection radiateur en place tout en installant le contour en plastique de l'autre côté de la moto.

R&G Racing

Unit 1, Shelley's Lane, East Worldham, Alton, Hampshire, GU34 3AQ

Tel: +44 (0)1420 89007 Fax: +44 (0)1420 87301 www.rg-racing.com Email: info@rg-racing.com



- Du côté droit de la moto, les supports de protection du radiateur doivent s'aligner approximativement avec les trous de montage sur le côté du radiateur. Remettez le contour du radiateur en plastique en place en vous assurant que les supports latéraux reposent sur le dessus des supports de protection du radiateur, avant de remonter les boulons d'origine à travers le cadre en plastique, puis à travers les supports de protection du radiateur et serrez dans le radiateur, comme indiqué sur (photos 10). & 11).
- Du côté gauche de la moto, retirez le boulon desserré précédemment installé, laissez le contour en plastique reposer contre le radiateur, assurez-vous que tous les trous soient alignés et réinsérez les deux boulons d'origine à travers le contour du radiateur, puis à travers la protection radiateur et serrez dans le côté du radiateur, comme indiqué sur (photo 12).
- Remontez le boulon d'origine qui fixe le centre de la protection de radiateur en place sous la poupée, avant de vérifier que la protection et l'entourage de radiateur soient correctement montés puis serrez les cinq boulons.
- Remontez les capots en plastique du radiateur des deux côtés de la moto et serrez les trois boulons des deux côtés.
- Remontez le couvercle en caoutchouc sur le goulot de remplissage du radiateur avant de remonter le bouchon de remplissage du radiateur.

Montage sur Ducati Supersport 950 + S 2021- (articles 4 et 5 requis)

- Les contours ou le carénage du radiateur devront être retirés pour accéder aux trous de montage du radiateur de chaque côté du radiateur, comme indiqué sur la (photo 15).
- Pour retirer le carénage et le contour du radiateur,
- Retirez le boulon 1 x du côté droit du radiateur comme indiqué sur la flèche (photo 19).
- Desserrez 1 x boulon comme indiqué sur la flèche (photo 20) pour permettre au support du klaxon de pivoter.
- Retirez le boulon 1 x du côté gauche du radiateur comme indiqué sur la flèche (photo 21).
- Présentez la protection du radiateur sur le radiateur et alignez les trous de montage avec les trous de boulons.
- Remplacez les boulons d'origine ainsi que les 2 boulons et rondelles fournis (articles 4 et 5) dans les 2 points de montage inférieurs des deux côtés du radiateur comme indiqué sur (photos 20 et 21).
- Assurez-vous que les boulons de fixation soient bien serrés avant de remonter les entourages ou le carénage de radiateur.
- Vérifiez le serrage de tous les boulons et que tous les panneaux soient sécurisés avant de rouler.

Montage sur Ducati Diavel 1260S 2019-2020

- Retirez les panneaux latéraux de clignotants selon les instructions précédentes, en coupant les attaches de câble pour ranger le câblage des clignotants afin de libérer les panneaux, comme indiqué sur (photo 13).

R&G Racing

Unit 1, Shelley's Lane, East Worldham, Alton, Hampshire, GU34 3AQ

Tel: +44 (0)1420 89007 Fax: +44 (0)1420 87301 www.rg-racing.com Email: info@rg-racing.com



- Fixez la protection radiateur au radiateur à l'aide de 4 des colliers de serrage inclus, comme illustré sur la (photo 14).
- Reposer les panneaux latéraux et remettre en ordre le câblage des clignotants à l'aide des 4 autres colliers de serrage.
- Vérifiez le serrage de tous les boulons et que tous les panneaux soient sécurisés avant de rouler.

ISSUE 1 - 12/10/2021 (AO)

CONSUMER NOTICE

The catalogue description and any exhibition of samples are only broad indications of the Products and R&G may make design changes which do not diminish their performance or visual appeal and supplying them in such state shall conform to the order. The Buyer acknowledges no representation or warranty (other than as to title) has been given or will apply to the Products other than those in R&G's order or confirmation and the Buyer confirms it has chosen the Products as being of merchantable quality and suitable for its particular purposes. Where R&G fits the Products or undertakes other services it shall exercise reasonable skill and care and rectify any fault free of charge unless the workmanship has been disturbed. The Buyer is responsible for ensuring that the warranty on the motorcycle is not affected by the fitting of the Products. On return of any defective Products R&G shall at its option either supply a replacement or refund the purchase money but shall not be liable if the Products have been modified or used or maintained otherwise than in accordance with R&G's or manufacturer's instructions and good engineering practice or if the defect arises from accident or neglect. Other than identified above and subject to R&G not limiting its liability for causing death and personal injury, it shall not be liable for indirect or consequential loss and otherwise its liability shall be limited to the amounts paid by the Buyer for the Products or the fitting or service concerned. These terms do not affect the Buyer's statutory rights.

R&G RACING RETURNS POLICY (NON-FAULTY GOODS)

Returns must be pre-authorized (if not pre-authorized the return will be rejected). Goods may only be returned direct to us if they were purchased direct from us (customer must prove if necessary). Otherwise to be returned to original vendor. Goods must be in re-sellable condition, in the opinion of R&G Racing. All returns are subject to a 25% restocking and handling fee (25% of the gross value exc. P&P - at the prevailing price at time of purchase). The customer must pay any and all carriage charges. No returns of discontinued products, unless within 14 days of purchase. This policy does not affect your statutory rights and does not refer to faulty goods.

R&G Racing

Unit 1, Shelley's Lane, East Worldham, Alton, Hampshire, GU34 3AQ

Tel: +44 (0)1420 89007 Fax: +44 (0)1420 87301 www.rg-racing.com Email: info@rg-racing.com



MONTAGEANLEITUNG FÜR BRG0015SS KÜHLERSCHUTZ
DUCATI HYPERMOTARD 950 2019-, MONSTER 1200 + 821 2014-,
SUPERSPORT 2017, SUPERSPORT 950 + S 2021-, DIAVEL 1260S 2019-2020

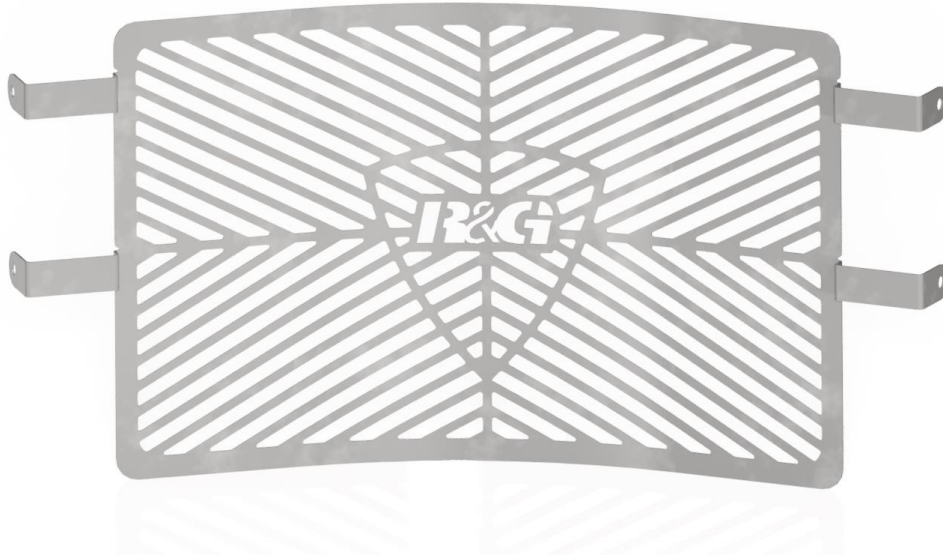

ALLE KIT-TEILE SIND AUF DEN NACHFOLGENDEN SEITEN ABGEBILDET UND GEKENNZEICHNET.

DIE ABGEBILDETEN TEILE DIENEN LEDIGLICH ZUR ERKLÄRUNG.

ÜBERPRÜFEN SIE ZUERST, DASS ALLE TEILE VORHANDEN SIND.

LESEN SIE DIE MONTAGEANLEITUNG KOMPLETT DURCH, BEVOR SIE ANFANGEN.

WENN SIE BEI DER MONTAGE DIESES PRODUKTES UNSICHER SIND, BITTE EINEN UNSERER HÄNDLER KONTAKTIEREN ODER DAS KIT VON EINEM QUALIFIZIERTEN ZWEIRAD-MECHANIKER MONTIEREN LASSEN.

DIE VERPACKUNG DER TEILE STELLT NICHT DIE REIHENFOLGE DER MONTAGE DAR.

HINWEIS FÜR KITS MIT PLASTIKUNTERLEGSscheiben AN DEN SCHRAUBEN –
DIESE PLASTIK-UNTERLEGSscheiben WERDEN NICHT FÜR DEN EINBAU BENÖTIGT

EINE DIGITALE VERSION DIESER MONTAGEANLEITUNG KANN AUF FOLGENDER SEITE HERUNTERGELADEN WERDEN:

WWW.RG-RACING.COM

R&G Racing

Unit 1, Shelley's Lane, East Worldham, Alton, Hampshire, GU34 3AQ

Tel: +44 (0)1420 89007 Fax: +44 (0)1420 87301 www.rg-racing.com Email: info@rg-racing.com

**SIE BENÖTIGEN FOLGENDES WERKZEUG**

- Steckschlüsselsatz inkl. 4mm and 8mm A/F
- Satz Inbusschlüssel inkl. 3mm – 8mm
- Seitenschneider

ALLGEM. ANZUGSDREHMOMENT

M4 SCHRAUBE = 8Nm
 M5 SCHRAUBE = 12Nm
 M6 SCHRAUBE = 15Nm
 M8 SCHRAUBE = 20Nm
 M10 SCHRAUBE = 40Nm
 M12 SCHRAUBE = 40Nm

LIEFERUMFANG

ARTIKEL NR.	BESCHREIBUNG	MENGE
ARTIKEL 1	RAD0172 KÜHLERSCHUTZ	1
ARTIKEL 2	CT220 220mm KABELBINDER	8
ARTIKEL 3	100mm SELBSTKLEBENDER SCHAUMSTOFF	2
ARTIKEL 4	M5 x 12mm INBUSSCHRAUBE	2
ARTIKEL 5	M5 UNTERLEGSCHIEBE	2

MONTAGE - ABBILDUNGEN

Abbildung 1



Abbildung 2

R&G Racing

Unit 1, Shelley's Lane, East Worldham, Alton, Hampshire, GU34 3AQ

Tel: +44 (0)1420 89007 Fax: +44 (0)1420 87301 www.rg-racing.com Email: info@rg-racing.com



Abbildung 3



Abbildung 4



Abbildung 5



Abbildung 6



Abbildung 7



Abbildung 8



Abbildung 9

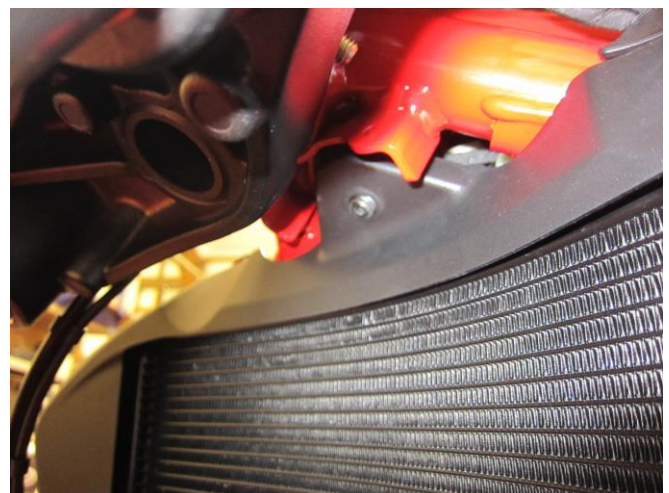

Abbildung 10



Abbildung 11



Abbildung 12



Abbildung 13

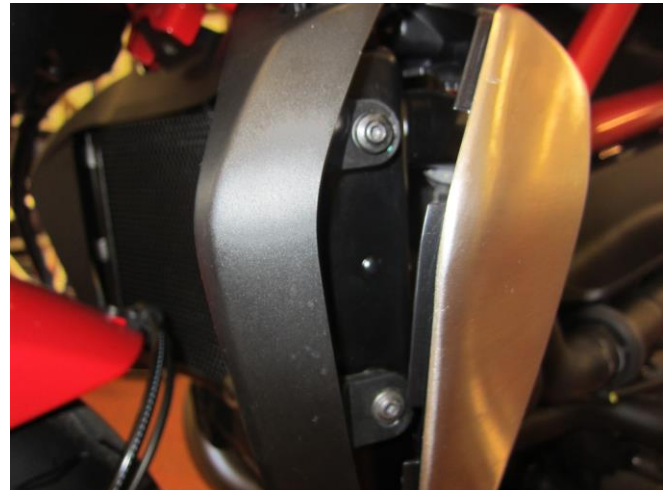

Abbildung 14

R&G Racing

Unit 1, Shelley's Lane, East Worldham, Alton, Hampshire, GU34 3AQ

Tel: +44 (0)1420 89007 Fax: +44 (0)1420 87301 www.rg-racing.com Email: info@rg-racing.com



Abbildung 15



Abbildung 16



Abbildung 17

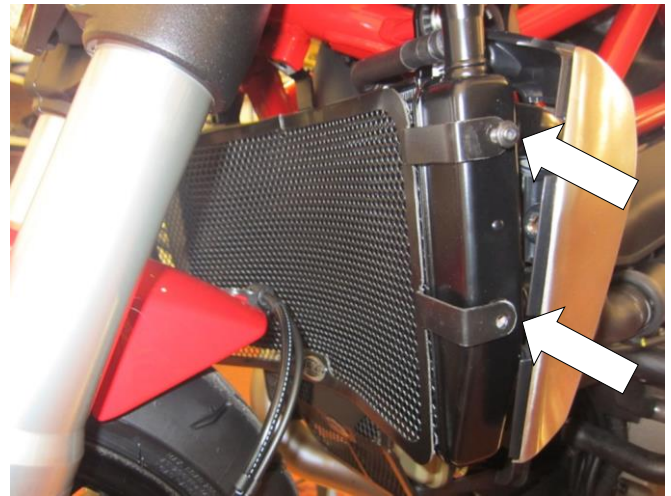

Abbildung 18



Abbildung 19

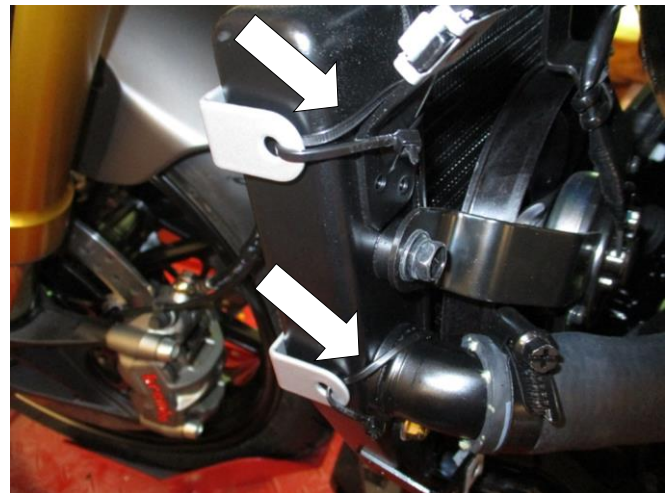

Abbildung 20

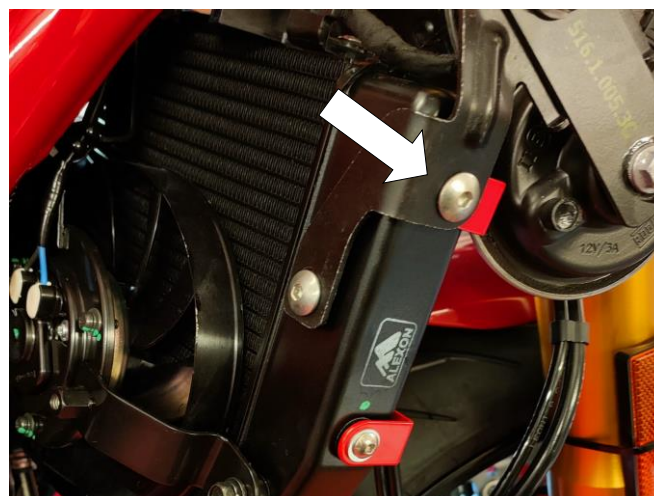

Abbildung 21

MONTAGEANLEITUNG

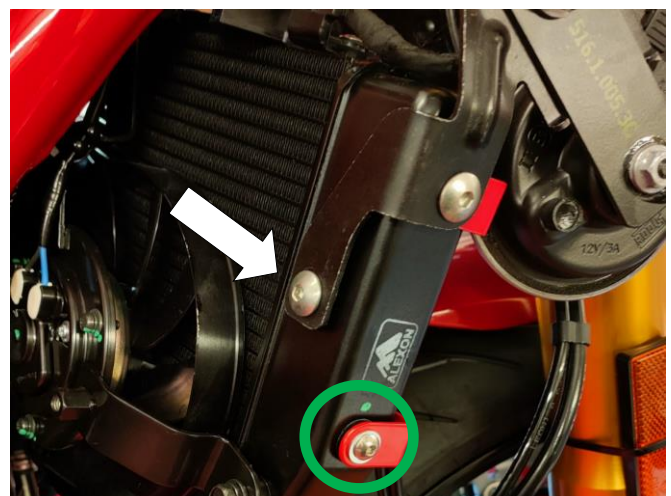
Bei Montage an Ducati Hypermotard 950 2019-, Monster 1200 + 821 2014-, Supersport 2017-

- Um den Kühlerschutz am Motorrad zu montieren, schneiden Sie zuerst die mitgelieferten Schaumstoffstreifen in 10 mm breite Streifen und kleben Sie diese auf der Rückseite des Kühlerschutzrahmens, so dass sie zwischen dem Kühlerschutz und dem Kühler angebracht sind.
- Entfernen Sie die drei 4mm Schrauben auf der rechten Seite des Motorrades, die die Plastikverkleidung am Kühler hinten befestigen – siehe **Abbildung 1**.
- Entfernen Sie die Plastikverkleidung am Kühler – siehe **Abbildung 2**.
- An der linken Seite des Motorrades, entfernen Sie den Kühlerdeckel und ziehen Sie die Plastikabdeckung über den Hals des Kühlerschlusses – **siehe Abbildungen 3 & 4**.
- Entfernen Sie die drei 4mm Schrauben, die die Plastikverkleidung hinten am Kühler befestigen – siehe **Abbildung 5**.
- Diese Plastikverkleidung kann nicht komplett vom Motorrad entfernt werden – sie kann nur etwas weggezogen werden, um Zugang zu den zwei Schrauben an der Seite des Kühlers zu ermöglichen – siehe **Abbildung 6**.
- Entfernen Sie die zwei Schrauben an beiden Seiten des Kühlers, die die Plastikverkleidung um den Kühler befestigen – siehe **Abbildungen 6 & 7**.
- Entfernen Sie die übrige Schraube, die unter dem Steuerkopf positioniert ist und die Plastikverkleidung am Kühler befestigt (siehe **Abbildung 8**), bevor Sie die Plastikverkleidung vom Motorrad entfernen.
- Den R&G Kühlerschutz in Position bringen und eine Originalschraube durch die Montageöffnung an der linken Seite des Motorrades einführen. Die Schraube mit nur 2 – 3 Drehungen in die Seite des

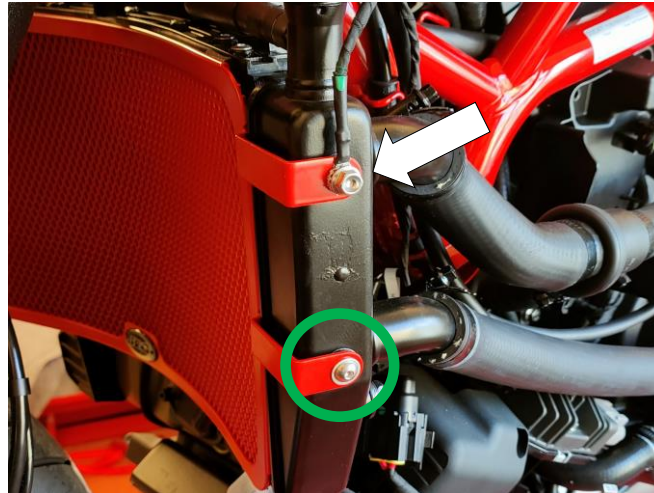
R&G Racing

Unit 1, Shelley's Lane, East Worldham, Alton, Hampshire, GU34 3AQ

Tel: +44 (0)1420 89007 Fax: +44 (0)1420 87301 www.rg-racing.com Email: info@rg-racing.com



Kühlers einschrauben– siehe **Abbildung 9**. *Der Kühlerschutz wird somit leicht in Position gehalten, während die Plastikverkleidung auf der anderen Seite des Motorrades montiert wird.*

- An der rechten Seite des Motorrades sollten die Halterungen für den Kühlerschutz mit den Montageöffnungen an der Seite des Kühlers bündig sein. Die Plastikverkleidung (um den Kühler) wieder in Position anbringen – bitte darauf achten, dass die Seitenhalterungen über den Kühlerschutzhalterungen liegen, bevor Sie die Originalschrauben durch die Plastikverkleidung, dann durch die Kühlerschutzhalterungen führen und anschließend im Kühler befestigen – siehe Abbildungen **10 & 11**.
- An der linken Seite des Motorrades die zuvor lose angeschraubte Schraube entfernen und die Plastikverkleidung hinten am Kühler anliegen lassen. Überprüfen Sie, dass alle Öffnungen bündig sind, dann die zwei Originalschrauben durch die Verkleidung (um den Kühler) und den Kühlerschutz führen und anschließend an der Seite des Kühlers befestigen, wie in **Abbildung 12** abgebildet.
- Montieren Sie die Originalschraube, die die Mitte des Kühlerschutz in Position unter dem Steuerkopf befestigt. Danach überprüfen Sie, dass der Kühlerschutz und die Verkleidung korrekt montiert sind, und ziehen Sie alle fünf Schrauben fest.
- Montieren Sie die Kühlerverkleidungen an beiden Seiten des Motorrades und ziehen Sie die drei Schrauben an beiden Seiten des Motorrades fest.
- Montieren Sie die Plastikabdeckung am Hals des Kühlerverschlusses, bevor Sie den Kühlerdeckel wieder montieren.

Bei Montage an Ducati Supersport 950 + S 2021- (Artikel 4 und 5 werden benötigt)

- Die Verkleidungsteile für den Kühler und/oder die Verkleidungen müssen entfernt werden, um Zugang zu den Montageöffnungen für den Kühler an beiden Seiten des Kühlers zu ermöglichen (siehe **Abbildung 15**).
- Um die Verkleidungen und das Verkleidungsteil (am Kühler) zu entfernen:
- Entfernen Sie die Schraube an der rechten Seite des Kühlers, die in (**Abbildung 19**) gekennzeichnet ist.
- Lösen Sie die Schraube, die in **Abbildung 20** gekennzeichnet ist, um die Halterung für die Hupe zu drehen.
- Entfernen Sie die Schraube an der linken Seite des Kühlers, die in (**Abbildung 21**) gekennzeichnet ist.
- Den Kühlerschutz an den Kühler ansetzen und überprüfen, dass die Montageöffnungen mit den Öffnungen für die Schrauben bündig sind.
- Ersetzen Sie die Originalschrauben mit den 2 Schrauben und Unterlegscheiben vom Kit (**Artikel 4 und 5**) und setzen Sie sie in die 2 untere Befestigungspunkte an beiden Seiten des Kühlers ein (wie in **Abbildungen 20 und 21** markiert).
- Stellen Sie sicher, dass die übrigen Schrauben festgezogen sind, bevor Sie das Verkleidungsteil für den Kühler und/oder die Verkleidungsteile wieder montieren.
- Überprüfen Sie, dass alle Schrauben ordnungsgemäß angezogen sind und alle Verkleidungsteile sicher befestigt sind, bevor Sie mit dem Motorrad fahren.

R&G Racing

Unit 1, Shelley's Lane, East Worldham, Alton, Hampshire, GU34 3AQ

Tel: +44 (0)1420 89007 Fax: +44 (0)1420 87301 www.rg-racing.com Email: info@rg-racing.com



Bei Montage an Ducati Diavel 1260S 2019-2020

- Entfernen Sie die Seitenverkleidungsteile für die Blinker gemäß der vorherigen Anleitung und schneiden Sie die Kabelbinder, die die Verkabelung befestigen, um die Verkleidungsteile zu lösen – siehe **Abbildung 13**.
- Sichern Sie den Kühlerschutz am Kühler mit 4 Kabelbindern vom Kit wie in **Abbildung 14** abgebildet.
- Montieren Sie die Seitenverkleidungsteile wieder, und die Blinker für die Kabel mit den übrigen 4 Kabelbinder wieder ordentlich anbringen.
- Überprüfen Sie, dass alle Schrauben ordnungsgemäß angezogen sind und alle Verkleidungsteile sicher befestigt sind, bevor Sie mit dem Motorrad fahren.

AUSGABE 1 – 12/10/2021 (AO)

CONSUMER NOTICE

The catalogue description and any exhibition of samples are only broad indications of the Products and R&G may make design changes which do not diminish their performance or visual appeal and supplying them in such state shall conform to the order. The Buyer acknowledges no representation or warranty (other than as to title) has been given or will apply to the Products other than those in R&G's order or confirmation and the Buyer confirms it has chosen the Products as being of merchantable quality and suitable for its particular purposes. Where R&G fits the Products or undertakes other services it shall exercise reasonable skill and care and rectify any fault free of charge unless the workmanship has been disturbed. The Buyer is responsible for ensuring that the warranty on the motorcycle is not affected by the fitting of the Products. On return of any defective Products R&G shall at its option either supply a replacement or refund the purchase money but shall not be liable if the Products have been modified or used or maintained otherwise than in accordance with R&G's or manufacturer's instructions and good engineering practice or if the defect arises from accident or neglect. Other than identified above and subject to R&G not limiting its liability for causing death and personal injury, it shall not be liable for indirect or consequential loss and otherwise its liability shall be limited to the amounts paid by the Buyer for the Products or the fitting or service concerned. These terms do not affect the Buyer's statutory rights.

R&G RACING RETURNS POLICY (NON-FAULTY GOODS)

Returns must be pre-authorized (if not pre-authorized the return will be rejected). Goods may only be returned direct to us if they were purchased direct from us (customer must prove if necessary). Otherwise to be returned to original vendor. Goods must be in re-sellable condition, in the opinion of R&G Racing. All returns are subject to a 25% restocking and handling fee (25% of the gross value exc. P&P – at the prevailing price at time of purchase). The customer must pay any and all carriage charges. No returns of discontinued products, unless within 14 days of purchase. This policy does not affect your statutory rights and does not refer to faulty goods.

R&G Racing

Unit 1, Shelley's Lane, East Worldham, Alton, Hampshire, GU34 3AQ

Tel: +44 (0)1420 89007 Fax: +44 (0)1420 87301 www.rg-racing.com Email: info@rg-racing.com