



BMW Motorrad



Rider's Manual (US Model)

**R 1250 GS Adventure**

## Motorcycle/Retailer Data

### Motorcycle Data

---

Model

---

Vehicle identification number

---

Color number

---

Initial registration

---

License plate

### Retailer Data

---

Contact in Service

---

Ms./Mr.

---

Phone number

---

Retailer's address/phone number (company stamp)

## Welcome to BMW

Congratulations on choosing a motorcycle from BMW Motorrad and welcome to the community of BMW motorcycle owners and riders. Familiarize yourself with your new motorcycle so that you can ride it safely and confidently in all highway traffic situations.

### About this Rider's Manual

Please read this Rider's Manual carefully before starting to use your new BMW. It contains important information on how to operate the controls and how to get the most benefit from your BMW's advanced technical features.

In addition, it contains information on maintenance and care to help you maintain your motorcycle's reliability and safety, as well as its value.

Documentation confirming performance of scheduled maintenance is a precondition for generous handling of out-of-warranty claims and goodwill warranty treatment.

Should you want to sell your BMW one day, please also remember to turn over the Ride's Manual to the new owner. It is an important part of your motorcycle.

### Suggestions and complaints

If you have any questions concerning your motorcycle, your authorized BMW Motorrad retailer is always happy to provide advice and assistance.

We wish you many miles of safe and enjoyable riding on your BMW

BMW Motorrad.

01 40 9 446 667



# Table of Contents

<b>1 General instructions ....</b>	<b>5</b>	<b>3 Displays .....</b>	<b>23</b>	Electronic chassis and suspension adjustment (D-ESA) .....	70
Overview .....	6	Indicator and warning lights .....	24	Riding mode .....	74
Abbreviations and symbols .....	6	TFT display in Pure Ride view .....	25	PRO riding mode .....	76
Equipment .....	7	TFT display in the View menu .....	27	Cruise-control system .....	78
Technical Data .....	7	Warning lights .....	28	Hill Start Control .....	80
Notice concerning current status .....	8	<b>4 Operation.....</b>	<b>57</b>	Anti-theft alarm system (DWA) .....	83
Additional sources of information .....	8	Steering and ignition lock .....	58	Tire Pressure Monitor (TPM) .....	86
Certificates and operating permits .....	8	Ignition with Keyless Ride .....	60	Heated handlebar grips .....	86
Data memory.....	8	Emergency on/off switch (kill switch) .....	64	Rider and passenger seats .....	87
<b>2 Overviews .....</b>	<b>13</b>	Lights .....	64	Storage compartment .....	90
General view, left side .....	15	Hazard warning flashers .....	66	<b>5 TFT display .....</b>	<b>91</b>
General view, right side .....	17	Turn indicators .....	66	General notes .....	92
Underneath the seat .....	18	Antilock Braking System (ABS).....	67	Principle .....	93
Multifunction switch, left .....	19	Traction control (ASC/DTC) .....	69	Pure Ride view .....	99
Multifunction switch, right .....	21			General settings .....	101
Instrument cluster .....	22			Bluetooth.....	102
				My vehicle .....	105
				Navigation .....	108
				Media .....	110

Phone .....	110	Shifting gears .....	134	<b>9 Maintenance .....</b>	<b>159</b>
Display software		Brakes .....	135	General notes .....	160
version .....	111	Parking your motorcycle.....	137	Onboard tool set .....	160
Display license information.....	111	Refueling .....	137	Service tool set .....	161
<b>6 Setting.....</b>	<b>113</b>	Securing motorcycle for transportation .....	141	Front wheel stand.....	161
Mirrors .....	114	<b>8 Technology in detail.....</b>	<b>143</b>	Engine oil .....	162
Headlight.....	115	General notes .....	144	Brake system .....	164
Windshield .....	116	Antilock Braking System (ABS).....	144	Clutch .....	168
Clutch .....	116	Traction control (ASC/DTC) .....	147	Coolant.....	168
Brakes .....	117	Dynamic ESA .....	149	Tires .....	169
Shifting .....	120	Riding mode .....	150	Wheel rims and tires .....	170
Footrests.....	121	Dynamic Brake Control....	152	Wheels .....	171
Handlebars .....	122	Tire pressure control (TPC/RDC) .....	153	Air filter.....	177
Spring preload .....	123	Shift assistant .....	155	Light sources .....	179
Damping .....	124	Hill Start Control .....	156	Jump-starting .....	180
<b>7 Riding.....</b>	<b>125</b>	ShiftCam .....	157	Battery .....	182
Safety information.....	126			Fuses .....	186
Observe checklist .....	128			Data link connector .....	187
Before every journey:.....	128			<b>10 Accessories .....</b>	<b>189</b>
At every third refueling stop .....	129			General notes .....	190
Starting.....	129			Onboard power sockets.....	190
Breaking in .....	132			Case .....	191
Off-road use .....	133			Topcase.....	193
				Navigation system.....	195

<b>11 Care .....</b>	<b>201</b>	Anti-theft alarm system ...	223	<b>14 Appendix.....</b>	<b>251</b>
Care products .....	202	Dimensions .....	224	Certificate for Electronic	
Washing your motorcycle.....	202	Weights .....	226	Immobilizer .....	252
Cleaning sensitive motorcycle parts.....	203	Performance data .....	226	Certificate for Key-	
Paint care .....	204	<b>13 Service .....</b>	<b>227</b>	less Ride .....	254
Protective wax coating ....	204	Reporting safety		Certificate for Tire Pressure	
Store motorcycle .....	205	defects .....	228	Control .....	256
Return motorcycle to		BMW Motorrad Service ...	229	Certificate for TFT instru-	
use .....	205	BMW Motorrad Service		ment cluster.....	257
<b>12 Technical data .....</b>	<b>207</b>	History .....	229	<b>15 Index .....</b>	<b>260</b>
Troubleshooting chart .....	208	BMW Motorrad Mobility			
Threaded fasteners .....	211	Services.....	230		
Fuel .....	214	Maintenance proce-			
Engine oil .....	215	dures .....	230		
Engine .....	215	BMW Service .....	230		
Clutch .....	216	Maintenance schedule ....	233		
Transmission .....	216	Maintenance confirma-			
Rear-wheel drive .....	217	tions.....	234		
Frame .....	218	Service confirmations .....	248		
Suspension .....	218				
Brakes .....	219				
Wheels and tires .....	220				
Electrical system .....	222				

## **General instructions**

Overview .....	6
Abbreviations and symbols .....	6
Equipment .....	7
Technical Data .....	7
Notice concerning current status ....	8
Additional sources of information ....	8
Certificates and operating permits ...	8
Data memory .....	8

## Overview

This Rider's Manual has been designed to provide quick and efficient orientation. The quickest way for you to find information on specific topics is to consult the comprehensive index at the back of the manual. If you would like to start with a quick overview of your motorcycle, this information has been provided in chapter 2. All maintenance and repair work carried out on your motorcycle will be documented in Chapter 12. Documentation confirming performance of scheduled maintenance is a precondition for generous handling of out-of-warranty claims and goodwill warranty treatment.

When the time comes to sell your BMW, remember to hand over this Rider's Manual; it is an important part of the motorcycle.

## Abbreviations and symbols



**CAUTION** Hazard with low risk. Failure to avoid this hazard can result in minor or moderate injury.



**WARNING** Hazard with moderate risk. Failure to avoid this hazard can result in death or serious injury.



**DANGER** Hazard with high risk. Failure to avoid this hazard results in death or serious injury.



**ATTENTION** Special instructions and precautionary measures. Non-compliance can cause damage to the vehicle or accessories and warranty claims may be denied as a result.



**NOTICE** Special information on operating and inspecting your motorcycle as well

as maintenance and adjustment procedures.



Indicates the end of an item of information.



Instruction.



Result of an activity.



Reference to a page with more detailed information.



Indicates the end of accessory or equipment-dependent information.



Tightening torque.



Technical data.

NV

National-market version.



- OE Optional extra. BMW Motorrad optional extras are already completely installed during motorcycle production.
- OA Optional accessory. BMW Motorrad optional accessories can be purchased and installed at your authorized BMW Motorrad retailer.
- ABS Anti-Lock Brake System.
- ASC Automatic Stability Control.
- D-ESA Electronic chassis and suspension adjustment.
- DTC Dynamic Traction Control (optional equipment only in combination with Pro riding modes).

- DWA Anti-theft alarm.
- EWS Electronic immobilizer.
- TPC Tire Pressure Control (TPC).

## Equipment

When you ordered your BMW motorcycle, you chose various custom equipment items. This Rider's Manual describes optional equipment (OE) offered by BMW and selected optional accessories (OA). This explains why the manual may also contain descriptions of equipment which you have not ordered. Please note, too, that your motorcycle might not be exactly as illustrated in this manual on account of country-specific differences. If your motorcycle features equipment that is not described here, you can find these features described in a separate manual.

## Technical Data

All dimensions, weights and performance data contained in this Rider's Manual refer to the German DIN standards and comply with their tolerance specifications. The technical data and specifications in this Rider's Manual serve as points of reference. The vehicle-specific data may vary, for instance due to the selected optional equipment, national-market version or country-specific measuring procedures. Detailed values can be obtained from the registration documents and the signs on the vehicle or from your authorized BMW Motorrad retailer or other qualified service partner or specialist workshop. The information on the vehicle documents always takes precedence over the information in this Rider's Manual.

## Notice concerning current status

The high safety and quality standards of BMW motorcycles are maintained by consistent, ongoing development efforts embracing their design, equipment and accessories. For this reason, some aspects of your motorcycle may vary from the descriptions in these operating instructions. In addition, BMW Motorrad cannot guarantee the total absence of errors. We hope you will appreciate that no claims can be recognized based on the data, illustrations or descriptions in this manual.

## Additional sources of information

### BMW Motorrad retailers

Your BMW Motorrad retailer is always happy to answer any of your questions.

## Internet

The Rider's Manual for your vehicle, the operating and installation instructions for optional accessories and general BMW Motorrad information related to the technology or other features are available at **[www.bmw-motorrad.com/service](http://www.bmw-motorrad.com/service)**.

## Certificates and operating permits

The certificates for the vehicle and the official operating permits for possible accessories are available at **[www.bmw-motorrad.com/certification](http://www.bmw-motorrad.com/certification)**.

## Data memory

### General

Electronic control units are installed in the vehicle. Electronic control units process data received from vehicle sensors,

self-generated data or data exchanged between control units, for example. Some control units are required for safe vehicle operation or provide driving assistance, such as driver assistance systems. Control units also make comfort and infotainment functions possible.

Information about the stored or exchanged data can be obtained from the vehicle manufacturer, such as in the form of a separate booklet.

### Personal references

Every vehicle is marked with a unique vehicle identification number. Depending on the country, the vehicle owner can be identified using the vehicle identification number and license plate and with the help of the relevant authorities. There are also other ways to trace data obtained from the vehicle back to the rider or

vehicle owner, such as via the used ConnectedDrive Account.

## Data privacy laws

In accordance with applicable data privacy laws, vehicle users have certain rights over the vehicle manufacturer or company that collects or processes personal data.

Vehicle users have the right to obtain comprehensive information without charge from the locations that store the vehicle user's personal data.

These locations may be:

- The vehicle manufacturer
- Qualified service partners
- Specialist workshops
- Service providers

Vehicle users may request information about the type of personal data that is stored, the purpose for which the data will be used and the source of the data.

This information can only be obtained by a registered owner or a person with written proof authorizing use of the vehicle.

The right to information also includes information related to data transmitted to other companies or locations.

The vehicle manufacturer's website contains the appropriate privacy policy notices. The privacy policy notices contain information on the right to delete or correct data. The vehicle manufacturer also provides the manufacturer contact information and the contact information of the data security officer.

The vehicle owner can have a BMW Motorrad retailer or other qualified service partner or specialist workshop read out the data stored in the vehicle for a fee if required.

The vehicle data is read out via the power socket required by law

for on-board diagnosis (OBD) in the vehicle.

## Legal requirements for the disclosure of data

The vehicle manufacture is required by the law applicable in this context to provide authorities with the data stored by the manufacturer. Providing this data within the scope required is on a case-by-case basis, for instance to clarify a criminal offense.

Government agencies are authorized by the law applicable in this context to read out the data from the vehicle themselves in individual cases.

## Operating data in the vehicle

Control units process data so that the vehicle can run.

Examples of these include:

- Status messages from the vehicle and its individual components, such as wheel RPM, wheel speed and deceleration
- Environmental conditions, such as temperature
- Operating conditions of system components, such as fill levels and tire pressure
- Malfunctions and faults in key system components, such as lights and brakes
- Vehicle responses in specific driving situations, such as activation of dynamic driving systems
- Information about events causing damage to the vehicle

The data is processed only in the vehicle itself and is usually temporary. The data is not stored beyond the period in which the vehicle is operating.

Electronic components such as control units contain components for storing technical information. This may be information about the vehicle's condition, component load, events or faults stored temporarily or permanently.

This information generally documents the condition of a component, module, system or the surrounding area; for example:

The data is necessary for providing control unit functions. In addition, it is used by the vehicle manufacturer to detect and eliminate malfunctions as well as to optimize vehicle functions.

The majority of this data is temporary and is processed only within the vehicle itself. Only a small amount of event-driven data is stored in the event data recorder and fault memory.

When a vehicle is serviced, such as for repairs, servicing processes, warranty cases and quality assurance measures, this technical information can be read out from the vehicle together with the vehicle identification number.

The information can be read out by a BMW Motorrad retailer or other qualified service partner or specialist workshop. The power socket required by law for on-board diagnosis (OBD) in the vehicle is used to read out the data. The data is collected, processed and used by the respective service network locations. The data documents the vehicle's technical states and helps with fault finding, compliance with warranty obligations and quality improvements.

The manufacturer also has product monitoring obligations arising from product liability law. The

vehicle manufacturer requires technical data from the vehicle in order to fulfill these obligations. The data from the vehicle can also be used to verify customer warranty and guarantee claims. The fault memory and event data recorder in the vehicle can be reset by a BMW Motorrad retailer or other qualified service partner or specialist workshop as part of repair work or servicing.

## **Data input and data transfer in the vehicle**

### **General**

Depending on the equipment, comfort settings and individualized settings in the vehicle can be saved and changed or reset at any time.

Examples of these include:

- Windshield position settings
- Chassis and suspension adjustment settings

It is possible to introduce data into the vehicle entertainment and communication system via a smartphone, for instance.

Depending on the individual equipment, this includes:

- Multimedia data, such as music for playback
- Address book data for use in conjunction with a communication system or integrated navigation system
- Entered navigation destinations
- Data about the use of Internet services. This data can be stored locally in the vehicle or is on a device connected to the vehicle, such as a smartphone, USB stick or MP3 player. If this data is saved in the vehicle, it can be deleted at any time.

This data is transmitted to third parties only upon personal request as part of the use of online

services. The data transmitted depends on the selected settings when using the services.

### **Integrating mobile end devices**

Depending on the equipment, mobile end devices connected to the vehicle, such as smartphones, are controlled using the vehicle's controls.

This enables audio and visual output from mobile end devices through the multimedia system. At the same time, certain information is transmitted to the mobile end device. This includes for instance position data and other general vehicle data, depending on the type of integration, and makes it possible to optimize the use of selected apps, such as those for navigation or music playback.

The way the data is processed further is determined by the provider of the particular app

used. The range of possible settings depends on the particular app and the operating system of the mobile end device.

## Services

### General

If the vehicle has a mobile phone connection, this connection makes it possible to exchange data between the vehicle and other systems. The mobile phone connection is made possible through the vehicle's transmitter and receiver or via personally integrated mobile end devices such as smartphones. Online functions, as they are called, are used over this mobile phone connection. These include online services and apps provided by the vehicle manufacturer or other providers.

### Vehicle manufacturer services

In the case of the vehicle manufacturer's online services, the particular functions are described at the appropriate location, such as in the Rider's Manual or on manufacturer's website. The relevant legal information on data privacy is also provided there. Personal data may be used in order to provide online services. The data is exchanged over a secure connection, i.e. with the vehicle manufacturer's IT systems which are intended for this purpose.

Any collection, processing and use of personal data that goes beyond the provision of services take place only as permitted by law, on the basis of a contractual agreement or as a result of consent. It is also possible to have the entire data connection activated or deactivated. This is not the case for legally prescribed functions.

### Services of other providers

When using the online services of other providers, these services are subject to the responsibility and the data protection and usage conditions of the respective provider. The vehicle manufacturer has no control over the content exchanged via these services. Information about the type, scope and purpose of collecting and using personal data as part of third-party services can be obtained from the particular service provider.



## Overviews

General view, left side.....	15
General view, right side .....	17
Underneath the seat .....	18
Multifunction switch, left .....	19
Multifunction switch, right.....	21
Instrument cluster .....	22





## General view, left side

- 1 Fuel filler opening  
( 138)
- 2 Seat lock ( 87)
- 3 Adjuster for rear damping (at the bottom on the spring strut) ( 124)
- 4 Tire pressure table (behind the side trim panel)

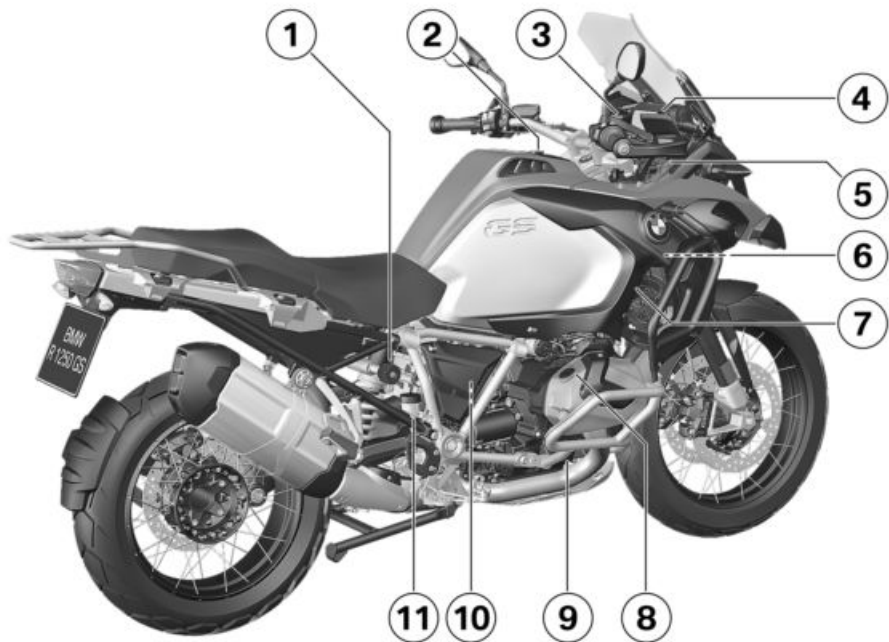

## General view, right side

- 1 Adjuster for spring preload, rear (➡ 123)
- 2 Air filter (under the center trim panel) (➡ 177)
- 3 Brake-fluid reservoir, front (➡ 166)
- 4 Height adjustment of the windshield (➡ 116)
- 5 Onboard power socket (➡ 190)
- 6 Vehicle identification number (on the steering-head bearing)  
Type plate (on the steering-head bearing)
- 7 Coolant level indicator (➡ 168)  
Coolant tank (➡ 169)
- 8 Oil filler opening (➡ 163)
- 9 Engine oil indicator (➡ 162)
- 10 Behind the side trim panel:  
Battery (➡ 182)  
Remote positive terminal (➡ 180)  
Data link connector (➡ 187)
- 11 Brake-fluid reservoir, rear (➡ 167)

## Underneath the seat

- 1 Standard tool kit (►► 160)
- 2 Rider's Manual (US Model)
- 3 Load capacity table
- 4 Adjustment of driver's seat height (►► 88)
- 5 Fuses (►► 186)

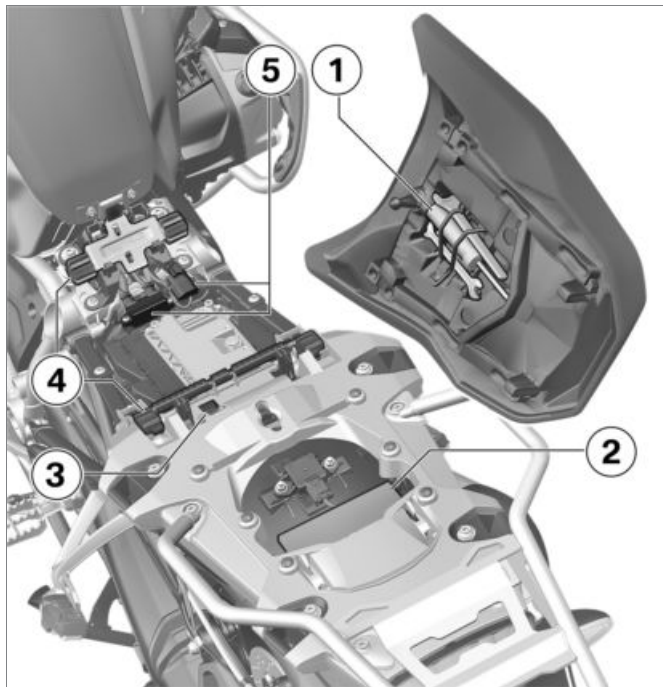

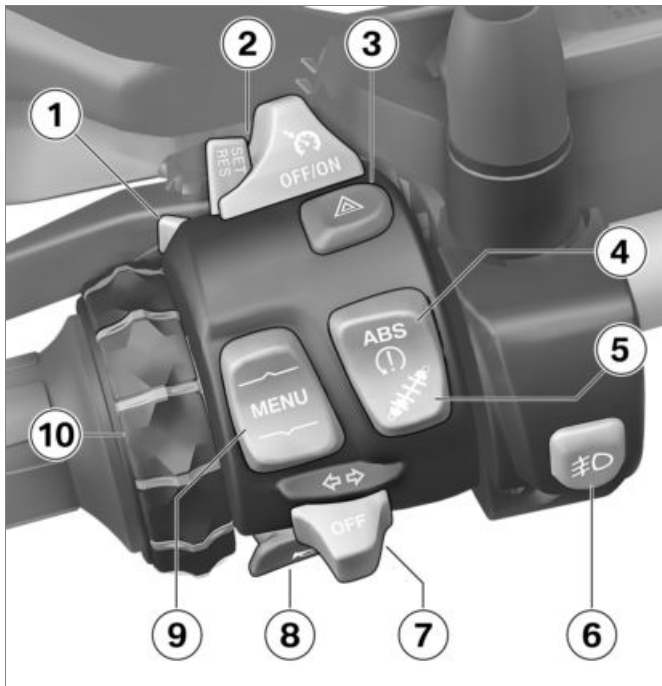

## Multifunction switch, left

- 1 High-beam headlight and headlight flasher (►► 64)
- 2 – with cruise control<sup>OE</sup>  
Cruise-control system (►► 78).
- 3 Hazard warning flashers (►► 66)
- 4 ABS (►► 67)  
ASC/DTC  
Switching the ASC/DTC function off (►► 69).
- 5 – with Dynamic ESA<sup>OE</sup>  
Dynamic ESA adjustment options (►► 71)
- 6 – with LED additional headlight<sup>OA</sup>  
Additional headlight (►► 65).
- 7 Turn indicators (►► 66)
- 8 Horn
- 9 Rocker button MENU (►► 93)

## 10 Multi-Controller Operating elements ( 93)

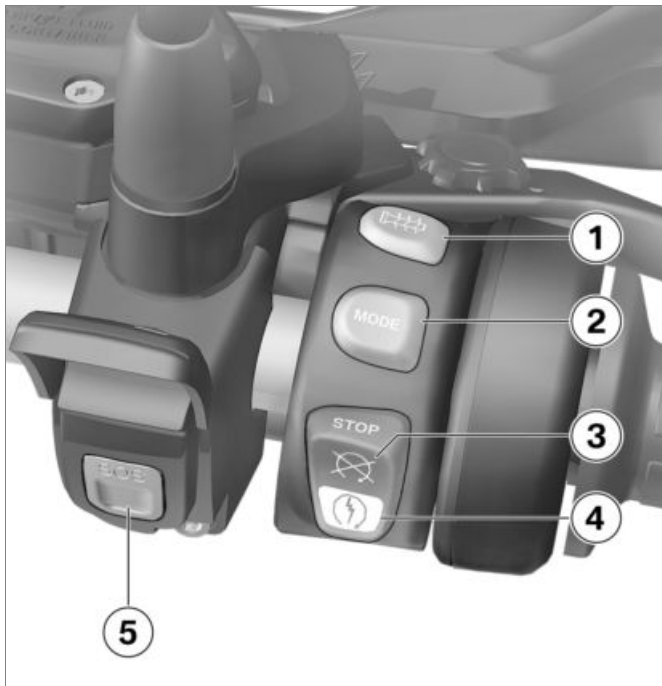

## Multifunction switch, right

- 1 – with heated grips<sup>OE</sup>  
Heated grips (➔ 86).
- 2 Riding mode (➔ 74)
- 3 Emergency on/off switch  
(kill switch) (➔ 64)
- 4 Starter button  
Starting engine (➔ 129).
- 5 SOS button

## Instrument cluster

- 1 Indicator and warning lights (►► 24)
- 2 TFT display (►► 25)  
(►► 27)
- 3 Anti-theft alarm LED  
– with anti-theft alarm system (DWA)<sup>OE</sup>  
Alarm signal (►► 84)  
– with Keyless Ride<sup>OE</sup>  
Indicator light for radio-operated key  
Switching on ignition (►► 61).
- 4 Photosensor (for adjusting brightness of instrument lighting)











## Displays

Indicator and warning lights .....	24
TFT display in Pure Ride view .....	25
TFT display in the View menu .....	27
Warning lights .....	28

## Indicator and warning lights

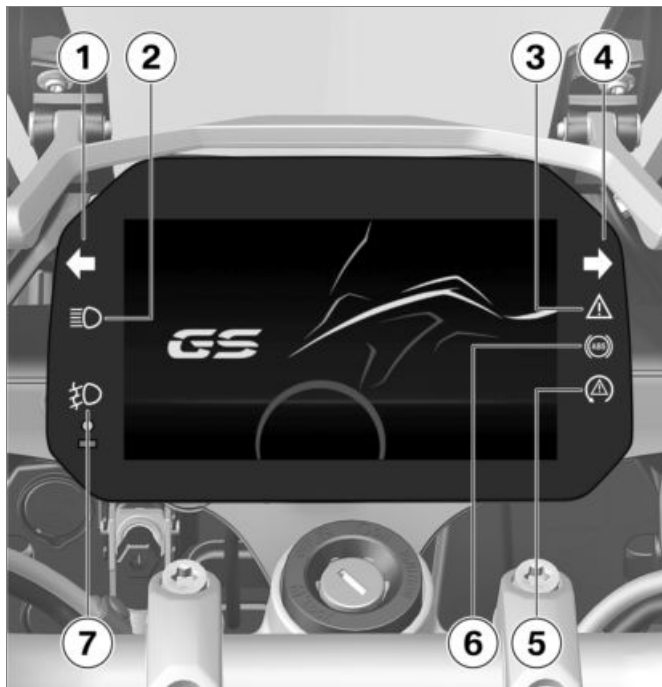

- 1 Turn indicator, left  
Operating turn signals  
( 66).
- 2 High beam ( 64)
- 3 General warning light  
( 28)
- 4 Turn indicator, right
- 5 ASC ( 50)  
– with riding modes Pro<sup>OE</sup>
- 6 DTC ( 50)
- 7 ABS ( 67)  
– with LED additional  
headlight<sup>OA</sup>  
Additional headlight  
( 65).

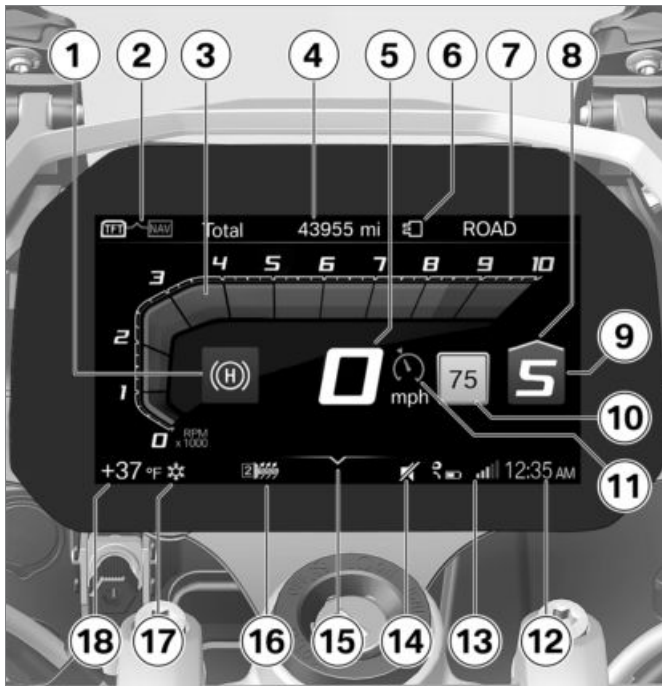



## TFT display in Pure Ride view

- 1 Hill Start Control (➡ 53)
- 2 Operating focus change (➡ 97)
- 3 Tachometer (➡ 99)
- 4 Driver info. status line (➡ 98)
- 5 Speedometer
- 6 Coding plug (➡ 77)
- 7 Riding mode (➡ 74)
- 8 Upshift recommendation (➡ 100)
- 9 Gear indicator, shows "N" in neutral (idling).
- 10 Speed Limit Info (➡ 99)
- 11 – with cruise control<sup>OE</sup>  
Cruise-control system (➡ 78).
- 12 Clock (➡ 101)
- 13 Connection status (➡ 103)
- 14 Mute (➡ 101)
- 15 Operating assistance

- 16** Heated grip settings  
( 86)
- 17** Outside temperature warning ( 38)
- 18** Outside temperature

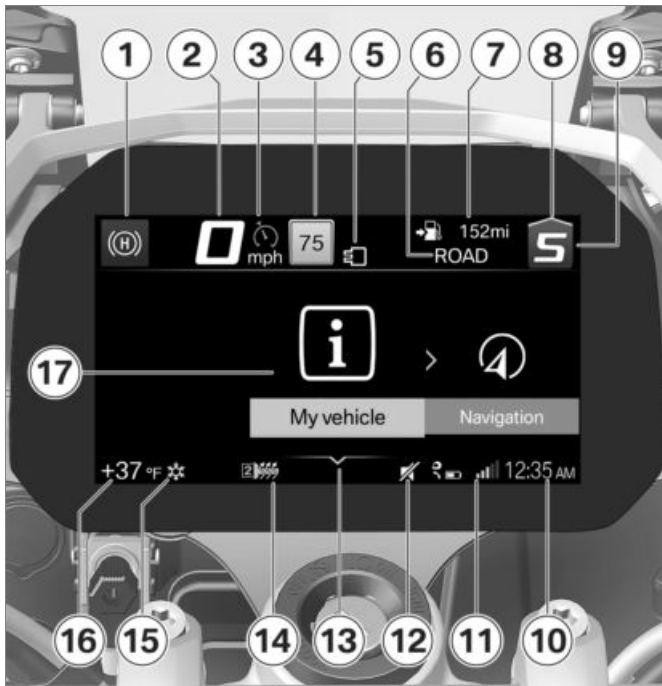

## TFT display in the View menu

- 1 Hill Start Control (➡ 53)
- 2 Speedometer
- 3 – with cruise control<sup>OE</sup>  
Cruise-control system (➡ 78).
- 4 Speed Limit Info (➡ 99)
- 5 Coding plug (➡ 77)
- 6 Riding mode (➡ 74)
- 7 Driver info. status line (➡ 98)
- 8 Upshift recommendation (➡ 100)
- 9 Gear indicator, shows "N" in neutral (idling).
- 10 Clock
- 11 Connection status
- 12 Mute (➡ 101)
- 13 Operating assistance
- 14 Heated grip settings (➡ 86)
- 15 Outside temperature warn-  
ing (➡ 38)

- 16 Outside temperature
- 17 Menu area

## Warning lights

### Display

Warnings are displayed with appropriate warning lights. Warnings are indicated by the general warning light in conjunction with a dialog in the TFT display. The general warning light lights up in either yellow or red depending on the urgency of the warning.



The general warning light lights up for the most urgent warning.

You will find an overview of the potential warnings on the following pages.



### Check Control display

The messages in the display are shown differently in the display. Different colors and characters are used depending on the priority:

- Green CHECK OK **1**: no message, values optimal.
- White circle with small "i" **2**: information.
- Yellow warning triangle **3**: warning message, value not optimal.
- Red warning triangle **3**: warning message, value critical

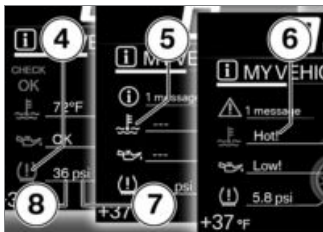

### Value display

The symbols **4** differ in their display. Different colors are used depending on the assessment of value. Instead of numerical values **8** with units **7**, texts **6** are also displayed:

### Color of the symbol

- Green: (OK) current value is optimal.
- Blue: (Cold!) current temperature is too low.
- Yellow: (Low! /High!) current value is too low or too high.
- Red: (Hot! /High!) current temperature or value is too high.

- White: (---) there is no valid value. Instead of the value, dashes **5** are displayed.

### NOTICE

The evaluation of the individual values is possible in part only after a certain riding duration or speed. If a measured value cannot yet be displayed due to unfulfilled measurement conditions, dashes are displayed instead as placeholders. As long as no valid measured value is available, no evaluation is carried out in the form of a colored symbol.◀



### Check Control dialog











Messages are output as Check Control dialog **1**.

- If several Check Control messages of the same priority are present, the messages change in the order in which they occur, until they are acknowledged.
- If the symbol **2** is active, this can be acknowledged by tilting the Multi-Controller to the left.
- Check Control messages are dynamically attached as additional tabs to the pages in the menu My vehicle (► 95). The message can be called up

again as long as the error persists.













## Overview of warning indicators

Indicator and warning lights	Display text	Meaning
	 Ice crystal symbol is displayed.	Outside temperature warning (►►► 38)
 General warning light lights up yellow.	 Key remote not in range.	Radio-operated key outside reception range (►►► 38)
 General warning light lights up yellow.	 Key remote battery at 50%.	Replacing the battery of the key fob transmitter (►►► 39)
	 Key remote battery low.	
 General warning light lights up yellow.	 Displayed in yellow.	Vehicle voltage too low (►►► 39)
	 Vehicle voltage low.	
 General warning light shows red.	 Displayed in red.	Vehicle voltage critical (►►► 40)

## Indicator and warning lights

## Display text











## Meaning

		Vehicle voltage critical!	Vehicle voltage critical (→ 40)
	General warning light lights up yellow.		The faulty light source is displayed. Light source defect (→ 40)
		Anti-theft alarm batt. capacity low.	Anti-theft alarm battery low charge (→ 41)
	General warning light lights up yellow.		Anti-theft alarm system battery discharged (→ 41)
		Engine oil level Check engine oil level	Electronic oil-level check: check engine oil level. (→ 42)
	General warning light shows red.		Coolant temperature too high!
	General warning light lights up yellow.		No communication with engine control. Engine control failure (→ 43)

## Indicator and warning lights

## Display text











## Meaning











 General warning light lights up yellow.	 Fault in the engine control.	Engine in emergency-operation mode (▶▶▶▶ 43)
 General warning light flashes yellow.	 Serious fault in engine control.	Serious fault in the engine control (▶▶▶▶ 44)
 General warning light lights up yellow.	 Displayed in yellow.	Tire pressure at the limits of the permissible tolerance (▶▶▶▶ 45)
	 Tire pressure not at setpoint.	
 General warning light flashes red.	 Displayed in red.	Tire pressure is outside the approved tolerance range (▶▶▶▶ 46)
	 Tire pressure not at setpoint.	
	 Tire press. monitor. Loss of pressure.	

## Indicator and warning lights

## Display text

## Meaning











		"---"	Transmission fault (►► 47)
 General warning light lights up yellow.		"---"	Sensor faulty or system fault (►► 48)
 General warning light lights up yellow.		TPM sensors battery low.	Battery of the tire pressure sensor weak (►► 48)
		Fall sensor faulty.	Fall sensor defective (►► 48)
		Side stand monitoring faulty.	Side stand monitoring faulty (►► 48)
 ABS indicator light flashes.			ABS self-diagnosis not completed (►► 49)
 ABS indicator light lights up.		Off!	ABS deactivated (►► 49)
		ABS deactivated.	

Indicator and warning lights	Display text	Meaning
 ABS indicator light lights up.	 Limited ABS availability!	ABS fault (→ 49)
 ABS indicator light lights up.	 ABS failure!	ABS failure (→ 49)
 ABS indicator light lights up.	 ABS Pro failure!	ABS Pro failure (→ 50)
 ASC/DTC indicator and warning light flashes quickly.		ASC/DTC intervention (→ 50)
 ASC/DTC indicator and warning light flashes slowly.		ASC/DTC self-diagnosis routine not completed (→ 50)
 ASC/DTC indicator and warning light lights up.	 Off!	ASC/DTC switched off (→ 51)
	 Traction control deactivated.	

## Indicator and warning lights

## Display text

## Meaning

	ASC/DTC indicator and warning light lights up.	 Traction control limited.	Limited ASC/DTC availability (►►► 51)
	ASC/DTC indicator and warning light lights up.	 Traction control failure!	ASC/DTC error (►►► 51)
	General warning light lights up yellow.	 Spring strut adjustment faulty!	D-ESA fault (►►► 52)
		 Fuel reserve is being used up. Drive to the nearest filling station.	Fuel down to reserve (►►► 52)
		 Green stop symbol is displayed.	Hill Start Control active (►►► 53)
		 Yellow stop symbol flashes.	Hill Start Control is automatically deactivated (►►► 53)
		 Crossed-out stop symbol is displayed.	Hill Start Control cannot be activated (►►► 53)

## Indicator and warning lights

## Display text

## Meaning



The gear indicator flashes.

Gear not trained (→ 53)



Left turn signal indicator light flashes green.

Hazard warning lights system switched on (→ 54)



Right turn signal indicator light flashes green.



Displayed in white.

Service due (→ 54)

Service due!



General warning light lights up yellow.



Displayed in yellow.

Service date missed (→ 54)

Service overdue!

## Outside temperature

The outside temperature is displayed in the status line of the TFT display.

Engine heat can lead to spurious readings of ambient temperature when the motorcycle is stationary. If the effect of the engine heat becomes excessive, dashes are temporarily displayed instead of the value.



If the outside temperature falls below the following limit value, there is a risk of black ice formation.



Limit value for outside temperature

Approx. 37 °F (Approx. 3 °C)

When this temperature is fallen short of for the first time, the outside temperature display flashes together with the ice crystal sym-

bol in the status line of the TFT display.

## Outside temperature warning



Ice crystal symbol is displayed.

Possible cause:



The outside temperature measured on the motorcycle is less than:

Approx. 37 °F (Approx. 3 °C)



### WARNING

#### Risk of black ice, even above 37 °F (3 °C)

Accident hazard

- At a low outside temperature, icy conditions must be expected on bridges and in shady road areas. ◀
- Think well ahead when driving.

## Radio-operated key outside reception range

– with Keyless Ride<sup>OE</sup>



General warning light lights up yellow.



Key remote not in range. It is not possible to turn on the ignition again.

Possible cause:

Communication between the key fob transmitter and the engine electronics is disrupted.

- Check the battery in the key fob transmitter.
- with Keyless Ride<sup>OE</sup>
- Replacing the battery of the key fob transmitter (▶▶▶ 63).
- Use reserve key for further driving.
- with Keyless Ride<sup>OE</sup>
- Battery of radio-operated key is completely drained or radio-



operated key has been lost (►►► 62).

- Should the Check Control dialog appear while riding, keep calm. You can continue driving; the engine will not turn off.
- Have the defective key fob transmitter replaced by an authorized BMW Motorrad retailer.

## Replacing the battery of the key fob transmitter



General warning light lights up yellow.



Key remote battery at 50%. No functional limitation.



Key remote battery low. Limited central locking function. Change battery.

Possible cause:

- The battery for the key fob transmitter is no longer charged to full capacity. Operation of the key fob transmitter is only ensured for a limited time.
  - with Keyless Ride<sup>OE</sup>
- Replacing the battery of the key fob transmitter (►►► 63).

## Vehicle voltage too low



General warning light lights up yellow.



Displayed in yellow.



Vehicle voltage low. Switch off unneeded consumers.



**WARNING**

## Failure of vehicle systems

Accident hazard

- Do not continue riding.◀

The battery is not being charged. If the journey is continued, the vehicle electronics will discharge the battery.



## NOTICE

If the 12-V battery is inserted incorrectly or the terminals reversed (e.g. when jump starting), it can blow the fuse for the alternator regulator.◀

Possible cause:

Defect in alternator or the alternator drive assembly, or the voltage regulator fuse has been triggered.

- Have the malfunction corrected as soon as possible at an authorized service facility, preferably an authorized BMW Motorrad retailer.

## Vehicle voltage critical

 General warning light shows red.

 Displayed in red.

 Vehicle voltage critical! Consumers were switched off Check battery condition.

### WARNING

#### Failure of vehicle systems

Accident hazard

- Do not continue riding.◀

The battery is not being charged. If the journey is continued, the vehicle electronics will discharge the battery.

### NOTICE

If the 12-V battery is inserted incorrectly or the terminals reversed (e.g. when jump starting),

it can blow the fuse for the alternator regulator.◀

Possible cause:

Defect in alternator or the alternator drive assembly, or the voltage regulator fuse has been triggered.

- Have the malfunction corrected as soon as possible at an authorized service facility, preferably an authorized BMW Motorrad retailer.

## Light source defect

 General warning light lights up yellow.

 The faulty light source is displayed:

 High beam faulty!

 Front left turn indicator faulty! or Front right turn indicator faulty!

 Low beam faulty!

 Front parking lamp faulty!

 Daytime riding light faulty!

– with LED additional headlight<sup>OA</sup>

 Left auxiliary headlight faulty! or Right auxiliary headlight faulty!◀

 Tail light faulty!

 Brake light faulty!

 Rear left turn indicator faulty! or Rear right turn indicator faulty!



License plate light faulty!

- Have checked by a specialist workshop.



## WARNING

### Overlooking the vehicle in traffic due to a defective light source on the vehicle

Safety risk

- Replace defective bulbs as soon as possible; it is best always to carry a complete set of spare bulbs on the motorcycle. ◀

Possible cause:

One or more lights are faulty.

- Identify faulty lights by visually inspecting them.
- Replace LED headlights (▶▶▶ 180).
- Replacing front and rear turn indicator light sources (▶▶▶ 179).

- Replacing LED tail light (▶▶▶ 180).

### Anti-theft alarm battery low charge

- with anti-theft alarm system (DWA)<sup>OE</sup>



Anti-theft alarm batt. capacity low. No limitations. Arrange an appointment at a specialist workshop.



## NOTICE

This fault message is only shown for a short time immediately following the Pre-Ride-Check. ◀

Possible cause:

The anti-theft alarm battery no longer has its full capacity. The operation of the anti-theft alarm system is only ensured for a limited time with the motorcycle battery disconnected.

- Contact an authorized service facility, preferably an authorized BMW Motorrad retailer.

### Anti-theft alarm system battery discharged

- with anti-theft alarm system (DWA)<sup>OE</sup>



General warning light lights up yellow.



Anti-theft alarm battery discharged. No independent alarm. Arrange an appointment at a specialist workshop.



## NOTICE

This fault message is only shown for a short time immediately following the Pre-Ride-Check. ◀

Possible cause:

The anti-theft alarm system battery is completely discharged. Operation of the anti-theft alarm system is no longer ensured when the motorcycle's battery is disconnected.

- Contact an authorized service facility, preferably an authorized BMW Motorrad retailer.

### Electronic oil-level check



The electronic oil-level check evaluates the oil level in the engine as OK or Low!

The following conditions must be satisfied in order to use the electronic oil-level check; multiple measurements may be necessary:

- Rider is sitting on the motorcycle and the motorcycle has been ridden at at least 6 mph (10 km/h) beforehand.

- Engine idling for at least 20 seconds.
- Engine is at operating temperature.
- Side (prop) stand is retracted and motorcycle is not resting on a center stand.
- No brake is engaged and Hill Start Control (HSC) is not active.
- Motorcycle stands vertically on a level surface.
- The spring strut is set according to the load status, or D-ESA is in the Auto loading mode.

If the measurement is incomplete or the conditions specified above are not fulfilled, an assessment of the oil level is not possible. Dashes (---) are indicated in place of the note.

### Electronic oil-level check: check engine oil level.



Engine oil level Check engine oil level.

Possible cause:

The electronic oil level sensor has detected a low engine oil level. If the motorcycle is not standing vertically on a level surface, the message can also appear even when the oil level is correct. At next refueling stop:

- Checking the engine oil level (➡ 162).

If the oil level is too low in the inspection glass:

- Topping up the engine oil (➡ 163).

If the oil level is correct in the inspection glass:

- Check whether the conditions for the electronic oil level check are fulfilled.

If the note appears multiple times even though the oil level is slightly below the MAX mark:

- Contact an authorized workshop, preferably an authorized BMW Motorrad retailer.

## Coolant temperature too high



General warning light shows red.



Coolant temperature too high! Check coolant level. Carry on at moderate pace to cool.



### ATTENTION

## Riding with overheated engine

Engine damage

- Be sure to observe the measures listed below.◀

Possible cause:

Coolant level is too low.

- Checking coolant level (▶▶ 168).

If coolant level is too low:

- Have the coolant refilled and the cooling system checked at a specialist service workshop, preferably an authorized BMW Motorrad retailer.

Possible cause:

The coolant temperature is too high.

- If possible, continue driving in the part-load range to cool down the engine.
- Should the coolant temperature frequently be too high, have the fault rectified as quickly as possible by an authorized workshop, preferably an authorized BMW Motorrad retailer.

## Engine control failure



General warning light lights up yellow.



No communication with engine control. Multiple sys. affected. Ride carefully to the next specialist workshop.

## Engine in emergency-operation mode



General warning light lights up yellow.



Fault in the engine control. Onward journey possible. Ride carefully to next specialist workshop.

## WARNING

### Unusual handling when the engine is in emergency operation

Accident hazard

- Avoid rapid acceleration and passing maneuvers. ◀

Possible cause:

The engine control unit has diagnosed a fault which impairs the engine performance or throttle response. The engine is running in the emergency-operation mode. In exceptional cases, the engine stops and can no longer be started.

- Have the malfunction corrected as soon as possible at an authorized service facility, preferably an authorized BMW Motorrad Retailer.
- » It is possible to continue riding, however the engine performance and engine speed range

may be impaired and not function as normal.

### Serious fault in the engine control



General warning light flashes yellow.



Serious fault in engine control. Onward journey possible. Damage possible. Have checked by a workshop.

## WARNING

### Damage to engine during emergency operation

Accident hazard

- Drive slowly and avoid rapid acceleration and passing maneuvers.
- If possible, have the vehicle picked up and the fault eliminated at a specialist workshop, preferably an authorized BMW Motorrad retailer. ◀

Possible cause:

The engine control unit has diagnosed a fault, which can lead to a severe secondary fault. The engine is in the emergency-operation mode.

- Continued driving is possible, however it is not recommended.
- Avoid high load and engine speed ranges if possible.
- Have the malfunction corrected as soon as possible at an authorized service facility, preferably an authorized BMW Motorrad Retailer.

### Tire inflation pressure

– with tire pressure monitor (TPM)<sup>OE</sup>

In addition to the MY VEHICLE menu window and the Check Control messages, there is also the TIRE PRESSURE window

to display the tire inflation pressures:

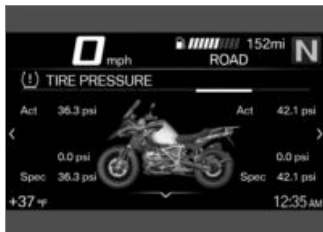

The values on the left relate to the front wheel and the values on the right relate to the rear wheel. The pressure differential is displayed via the actual and nominal tire pressure.

Immediately after switching on the ignition only dashes are displayed. The transfer of the tire pressure values does not begin until the minimum speed is exceeded for the first time:



TPC/RDC sensor is not active

min 19 mph (min 30 km/h)  
(The TPC/RDC sensor does not transmit a signal to the motorcycle until this minimum speed has been exceeded.)



The tire pressures are shown in the TFT display with temperature compensation and are always based on the following tire air temperature:

68 °F (20 °C)



If the tire symbol appears yellow or red at the same time, the display is a warning. The pressure differential is highlighted with an exclamation mark of the same color.



If the level concerned is borderline in terms of the permissible tolerance, the general warning light also lights up yellow.



If the monitored tire inflation pressure is outside the specified range the general warning light will flash red.

For further information about the BMW Motorrad tire pressure monitor, see the "Technology in detail" chapter from page (153).

### Tire pressure at the limits of the permissible tolerance.

– with tire pressure monitor (TPM)<sup>OE</sup>



General warning light lights up yellow.



Displayed in yellow.



Tire pressure not at setpoint. Check tire pressure.

Possible cause:

The measured tire pressure is within the limit range of the permissible tolerance.

- Correct tire pressure.
- Before adjusting the tire pressure, check the information on temperature compensation and tire pressure adjustment in the "Technology in detail" section:
  - » Temperature compensation (▣▶ 154)
  - » Tire pressure adjustment (▣▶ 154)
  - » The target tire pressures can be found in the following locations:
    - On the back cover of the rider's manual

- Instrument cluster in the TIRE PRESSURE view
- Sign underneath the seat

### Tire pressure is outside the approved tolerance range

- with tire pressure monitor (TPM)<sup>OE</sup>



General warning light flashes red.



Displayed in red.



Tire pressure not at setpoint. Stop immediately! Check tire pressure.



Tire press. monitor. Loss of pressure. Stop immediately! Check tire pressure.



## WARNING

### Tire pressure is outside the approved tolerance range.

Risk of accident, deterioration in the handling characteristics of the vehicle.

- Adjust the driving style.◀

Possible cause:

The measured tire pressure is outside of the permissible tolerance.

- Check the tires for damage and driveability.

Can the tire still be driven on:

- Correct the tire pressure at the next opportunity.
- Before adjusting the tire pressure, check the information on temperature compensation and tire pressure adjustment in the "Technology in detail" section:
  - » Temperature compensation (▣▶ 154)



- » Tire pressure adjustment (➡ 154)
- » The target tire pressures can be found in the following locations:
  - On the back cover of the rider's manual
  - Instrument cluster in the **TIRE PRESSURE** view
  - Sign underneath the seat
- Have the tires checked by a specialist workshop for damage, preferably an authorized BMW Motorrad retailer.



## NOTICE

The TPC/RDC warning message can be deactivated in the off-road mode. ◀

In the event of uncertainty about the driveability of the tire:

- Do not continue riding.
- Inform roadside assistance.

## Transmission fault

- with tire pressure monitor (TPM)<sup>OE</sup>



"----"

Possible cause:

The motorcycle has not reached the minimum speed (➡ 153).



TPC/RDC sensor is not active

min 19 mph (min 30 km/h)  
(The TPC/RDC sensor does not transmit a signal to the motorcycle until this minimum speed has been exceeded.)

- Watch the TCP/RDC display at a higher rate of speed. A continuous error is only present if the general warning lamp also lights up. In this case:
- Have fault eliminated at a specialist service facility, preferably

an authorized BMW Motorrad retailer.

Possible cause:

There is a fault in the radio connection to the TPC/RDC sensors. Possible causes are radio systems in the surrounding area, which interfere with the connection between the TPC/RDC control unit and the sensors.

- Watch the TPC/RDC display in another environment. A continuous error is only present if the general warning lamp also lights up. In this case:
- Have fault eliminated at a specialist service facility, preferably an authorized BMW Motorrad dealer.

## Sensor faulty or system fault

– with tire pressure monitor (TPM)<sup>OE</sup>



General warning light lights up yellow.



"----"

Possible cause:

Wheels without TPM sensors are fitted.

- Retrofit wheel set with TPM sensors.

Possible cause:

1 or 2 TCP/RDC sensors have failed or a system error has occurred.

- Have fault eliminated at a specialist service facility, preferably an authorized BMW Motorrad retailer.

## Battery of the tire pressure sensor weak

– with tire pressure monitor (TPM)<sup>OE</sup>



General warning light lights up yellow.



TPM sensors battery low. Function limited. Have checked by a specialist workshop.



### NOTICE

This fault message is only shown for a short time immediately following the Pre-Ride-Check. ◀

Possible cause:

The battery of the tire inflation pressure sensor no longer has its full capacity. The operation of the tire inflation pressure control is only ensured for a limited time.

- Contact an authorized workshop, preferably an authorized BMW Motorrad retailer.

## Fall sensor defective



Fall sensor faulty. Have checked by a specialist workshop.

Possible cause:

The fall sensor is not functioning.

- Contact an authorized service facility, preferably an authorized BMW Motorrad retailer.

## Side stand monitoring faulty



Side stand monitoring faulty. Onward journey possible. Stop engine when stationary! Have checked by workshop.

Possible cause:

The side-stand switch or its wiring is damaged.

- Contact an authorized service facility, preferably an authorized BMW Motorrad retailer.

## ABS self-diagnosis not completed



ABS indicator light flashes.

Possible cause:



ABS self-diagnosis routine not completed

ABS is not available, as the self-diagnosis routine was not completed. (The motorcycle must reach a specified minimum speed before the system can check operation of the wheel speed sensors: 3 mph (5 km/h))

- Ride off slowly. Please note that the ABS function is only

available after the self-diagnosis has completed.

## ABS deactivated



ABS indicator light lights up.



Off!



ABS deactivated.

Possible cause:

The ABS system was deactivated by the rider.

- Switch on ABS function (►► 68).

## ABS fault



ABS indicator light lights up.



Limited ABS availability! Onward journey possible. Ride carefully to next specialist workshop.

Possible cause:

The ABS control unit has detected an error. The partial integral brake and the Dynamic Brake Control function have failed. The ABS function is limited.

- It remains possible to continue riding. Observe additional information on special situations which can lead to ABS fault messages (►► 145).
- Have the malfunction corrected as soon as possible at an authorized specialist workshop, preferably an authorized BMW Motorrad retailer.

## ABS failure



ABS indicator light lights up.



ABS failure! Onward journey possible. Ride carefully to next specialist workshop.

Possible cause:

The ABS control unit has detected an error. The ABS function is not available.

- It remains possible to continue riding. Observe additional information on special situations which can lead to ABS fault messages (▮▮▮▮▶ 145).
- Have the malfunction corrected as soon as possible at an authorized service facility, preferably an authorized BMW Motorrad Retailer.

### ABS Pro failure

– with riding modes Pro<sup>OE</sup>



ABS indicator light lights up.



ABS Pro failure! Onward journey possible. Ride carefully to next specialist workshop.

Possible cause:

The ABS Pro control unit has detected a fault. The ABS Pro function is not available. The ABS function remains available. ABS only supports braking in straight-ahead riding.

- It remains possible to continue riding. Observe additional information on special situations which can lead to an ABS Pro fault message (▮▮▮▶ 145).
- Have the malfunction corrected as soon as possible at an authorized service facility, preferably an authorized BMW Motorrad Retailer.

### ASC/DTC intervention



ASC/DTC indicator and warning light flashes quickly.

ASC/DTC has detected instability at the rear wheel and responded by reducing the torque. The indicator and warning light flashes

longer than the ASC/DTC intervention lasts. This feature continues to furnish the rider with visual feedback confirming that the system has initiated active closed-loop intervention even after the critical situation has passed.

### ASC/DTC self-diagnosis routine not completed



ASC/DTC indicator and warning light flashes slowly.

Possible cause:



ASC/DTC self-diagnosis routine not completed

The ASC/DTC function is not available, as the self-diagnosis function has not been completed. (To check wheel speed sensors, motorcycle must reach a minimum speed with engine running: min 3 mph (min 5 km/h))

- Ride off slowly. The ASC/DTC indicator and warning light must go out after a few meters.

If the ASC/DTC indicator and warning light continues flashing:

- Contact an authorized workshop, preferably an authorized BMW Motorrad retailer.

### ASC/DTC switched off

 ASC/DTC indicator and warning light lights up.

 Off!

 Traction control deactivated.

Possible cause:

The ASC/DTC system was deactivated by the rider.

- Switching the ASC/DTC function on (➡ 70).

### Limited ASC/DTC availability

 ASC/DTC indicator and warning light lights up.

 Traction control limited. Onward journey possible. Ride carefully to next specialist workshop.

Possible cause:

The ASC/DTC control unit has detected a fault.

### ATTENTION

#### Damage to components

Damage to sensors, for example, with the resultant malfunctions

- Do not carry along any objects under the rider's or passenger's seat.
- Secure vehicle tools. ◀
- Do not damage the rotational speed sensor.

- It must be noted that only limited ASC/DTC function is available.
- It remains possible to continue riding. Observe additional information on situations that can lead to a ASC/DTC fault (➡ 148).
- Have the malfunction corrected as soon as possible at an authorized specialist workshop, preferably an authorized BMW Motorrad retailer.

### ASC/DTC error

 ASC/DTC indicator and warning light lights up.

 Traction control failure! Onward journey possible. Ride carefully to next specialist workshop.

Possible cause:

The ASC/DTC control unit has detected a fault.



## ATTENTION

### Damage to components

Damage to sensors, for example, with the resultant malfunctions

- Do not carry along any objects under the rider's or passenger's seat.
- Secure vehicle tools. ◀
- Do not damage the rotational speed sensor.
- It must be noted that the ASC/DTC function is not available at all or is restricted.
- It remains possible to continue riding. Observe additional information on situations that can lead to a ASC/DTC fault (▶▶ 148).
- Have the malfunction corrected as soon as possible at an authorized specialist workshop,

preferably an authorized BMW Motorrad retailer.

### D-ESA fault



General warning light lights up yellow.



Spring strut adjustment faulty! Onward journey possible. Ride carefully to next specialist workshop.

Possible cause:

The D-ESA control unit has detected a fault. Damping action and/or the spring adjustment may be the cause. In the Auto loading mode, the cause may be a fault in the function of the riding position compensation. In this state, the motorcycle is probably heavily damped and is uncomfortable to drive, particularly on poor roadways. Alternatively, the spring preload may be set incorrectly.

- Have the malfunction corrected as soon as possible at an authorized service facility, preferably an authorized BMW Motorrad Retailer.

### Fuel down to reserve



Fuel reserve is being used up. Drive to the nearest filling station.



## WARNING

### Rough engine running or switching off of the engine due to a fuel shortage

Accident hazard, damage to catalytic converter

- Do not drive to the extent that the fuel tank is completely empty. ◀

Possible cause:

At the most, the fuel tank still contains the reserve fuel quantity.



Reserve fuel quantity

Approx. 1.1 gal (Approx. 4 l)

- Refueling procedure (➡ 138).

### Hill Start Control active



Green stop symbol is displayed.

Possible cause:

The Hill Start Control (➡ 156) was activated by the rider.

- Switch off Hill Start Control.
- Using Hill Start Control (➡ 81).

### Hill Start Control is automatically deactivated



Yellow stop symbol flashes.

Possible cause:

Hill Start Control was deactivated automatically.

- Side stand was folded out.

» Hill Start Control is deactivated when the side stand is folded out.

- Engine was stopped.
- » Hill Start Control is deactivated when the engine is stopped.
- Using Hill Start Control (➡ 81).

### Hill Start Control cannot be activated



Crossed-out stop symbol is displayed.

Possible cause:

The Hill Start Control can not be activated.

- Fold in side stand.
- » Hill Start Control only functions when the side stand is folded in.
- Start engine.
- » Hill Start Control only functions with the engine running.

### Gear not trained

– with Gearshift Assistant Pro<sup>OE</sup>



The gear indicator flashes. The gearshift assistant Pro has no function.

Possible cause:

– with Gearshift Assistant Pro<sup>OE</sup>

The transmission sensor has not been programmed completely.

- Shift to idle **N** and let engine run at least 10 seconds while the motorcycle is stationary so that idle can be programmed in.
- Use clutch control to shift to all gears and drive at least 10 seconds in each gear.
- » The gear indicator stops flashing when the transmission sensor has been programmed successfully.
- If the transmission sensor has been programmed completely, the Pro gearshift assistant will operate as described (➡ 155).

- If the programming procedure is unsuccessful, have the fault eliminated at a specialist workshop, preferably an authorized BMW Motorrad retailer.

### Hazard warning lights system switched on



Left turn signal indicator light flashes green.



Right turn signal indicator light flashes green.

Possible cause:

The hazard warning lights system was switched on by the rider.

- Operating hazard warning flashers (➡ 66).

### Service display



If service is overdue, the due date or the odometer reading at which service was due is accompanied by the 'General' warning light showing yellow.

If service is overdue, a yellow CC message is displayed. The displays for service, service date, and remaining distance are also highlighted with exclamation marks in the menu windows MY VEHICLE and SERVICE REQUIREMENTS.



### NOTICE

If the service display appears more than a month before the service date, the current day's date must be reset in the instrument cluster. This situation can occur if the battery was disconnected.◀

### Service due



Displayed in white.

Service due! Have a service performed at a specialist workshop.

Possible cause:

Service is due because of the driving performance or the date.

- Have service performed regularly by a specialist workshop, preferably an authorized BMW Motorrad retailer.
- » The operating and road safety of the vehicle remains unchanged.
- » The best-possible value retention of the vehicle is ensured.

### Service date missed



General warning light lights up yellow.



Displayed in yellow.

Service overdue! Have a service performed at a specialist workshop.



Possible cause:

Service is overdue because of the riding performance or the date.

- Have service performed regularly by a specialist workshop, preferably an authorized BMW Motorrad retailer.
- » The operating and road safety of the vehicle remains unchanged.
- » The best-possible value retention of the vehicle is ensured.



## Operation

Steering and ignition lock .....	58	Tire Pressure Monitor (TPM) .....	86
Ignition with Keyless Ride .....	60	Heated handlebar grips .....	86
Emergency on/off switch (kill switch) .....	64	Rider and passenger seats .....	87
Lights .....	64	Storage compartment .....	90
Hazard warning flashers .....	66		
Turn indicators .....	66		
Antilock Braking System (ABS) .....	67		
Traction control (ASC/DTC) .....	69		
Electronic chassis and suspension adjustment (D-ESA) .....	70		
Riding mode .....	74		
PRO riding mode .....	76		
Cruise-control system .....	78		
Hill Start Control .....	80		
Anti-theft alarm system (DWA) .....	83		

## Steering and ignition lock

### Vehicle keys

You are provided with 2 ignition keys.

Should you lose your keys, refer to the information regarding the electronic immobilizer (EWS) (► 59).

A single key fits the steering and ignition lock, the fuel filler cap and the seat lock.

The cases and the Topcase can also be ordered with locks for the same key on request. Please contact an authorized workshop for this purpose, preferably an authorized BMW Motorrad retailer.

### Locking handlebars

- Turn handlebars to left.

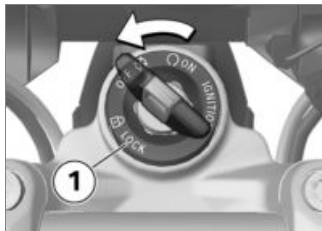

- Turn key to position **1** while moving handlebars slightly.
  - » Ignition, lights and all electrical circuits switched off.
  - » Handlebars are locked.
  - » Key can now be removed.

## Switching on ignition

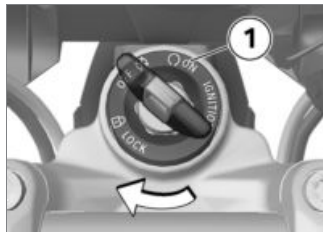

- Insert key into the steering and ignition lock. Turn key to position **1**.
  - » Parking light and all function circuits are switched on.
  - » Pre-Ride-Check is carried out. (► 130)
    - without riding modes Pro<sup>OE</sup>
    - » ASC self-diagnosis in progress. (► 131)◁
    - with riding modes Pro<sup>OE</sup>
    - » DTC self-diagnosis is performed. (► 131)◁

## Welcome light

- Switch on the ignition.
- » The parking lamp briefly lights up.

## Switch off ignition

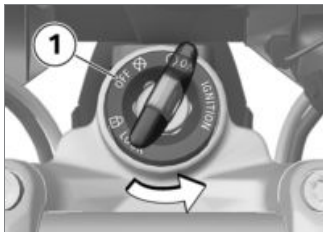

- Turn key to position **1**.
- » After the ignition is switched off, the instrument cluster remains switched on for a short period of time and indicates possibly present fault codes.
- » Handlebars not locked.
- » Electrically powered accessories remain operational for a limited period of time.

- » Battery can be recharged via onboard socket.
- » Key can now be removed.

– with LED additional headlight<sup>OA</sup>

- The supplementary LED headlights switch off shortly after the ignition is switched off.<

## EWS Electronic immobilizer

The motorcycle's electronic circuitry monitors the data stored in the ignition key through a ring antenna incorporated in the steering and ignition lock. The engine management system does not enable engine starting until this key has been recognized as "authorized" for your motorcycle.



A further key attached to the same ring as the ignition key

used to start the engine could "irritate" the electronics, in which case the enabling signal for starting is not issued.

Always store further vehicle keys separately from the ignition key.◀

If you lose one of your motorcycle keys, you can have it disabled by your authorized BMW motorcycle retailer.

When having a key disabled you should also bring all of the motorcycle's remaining keys with you. The engine can no longer be started using a disabled key; however, a disabled key can be enabled again.

Emergency and spare keys are only available through an authorized BMW Motorrad retailer. The keys are part of an integrated security system, so the retailer is under an obligation to check the legitimacy of all ap-

plications for replacement/extra keys.

## Ignition with Keyless Ride

– with Keyless Ride<sup>OE</sup>

### Vehicle keys

#### NOTICE

The indicator light for the radio-operated key flashes as long as the radio-operated key is being searched for.

If the radio-operated key or the emergency key is detected, it goes out.

If the radio-operated key or the emergency key is not detected, it lights up briefly. ◀

You are provided with one radio-operated key and one emergency key. Should you lose your keys, refer to the information regard-

ing the electronic immobilizer (EWS) (➡ 59).

The ignition, tank filler cap and anti-theft alarm system are controlled with the radio-operated key. The seat lock, Topcase and case can be operated manually.

#### NOTICE

When the range of the radio key is exceeded (e.g. in case or Topcase), the motorcycle cannot be started.

If the radio-operated key continues to be missing, the ignition is switched off after approx. 1.5 minutes to protect the battery charge.

It is advisable to carry the radio-operated key directly on your person (e.g. in a jacket pocket) and to also carry the emergency key as an alternative. ◀



Range of Keyless Ride radio-operated key

– with Keyless Ride<sup>OE</sup>

Approx. 3.3 ft (Approx. 1 m) ◀

## Locking handlebars Requirement

Handlebars are turned to the left. Radio-operated key is within reception range.

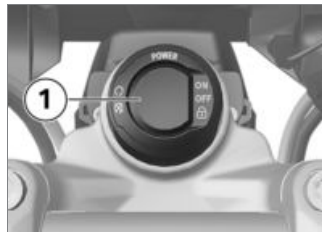

- Press and hold button **1**.
- » Steering lock audibly locks.
- » Ignition, lights and all electrical circuits switched off.

- To unlock the steering lock, briefly press button **1**.

## Switching on ignition Requirement

Radio-operated key is within reception range.

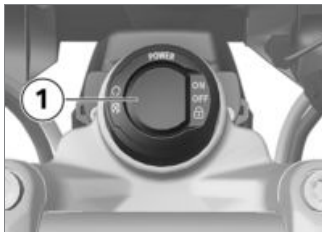

- The ignition can be activated in **two** ways.

### Version 1:

- Briefly press button **1**.
  - » Parking light and all function circuits are switched on.
  - » Pre-Ride-Check is carried out. (▶▶▶ 130)

- without riding modes Pro<sup>OE</sup>
  - » ASC self-diagnosis in progress. (▶▶▶ 131)◀
- with riding modes Pro<sup>OE</sup>
  - » DTC self-diagnosis is performed. (▶▶▶ 131)◀

### Version 2:

- Steering lock is locked, press and hold button **1**.
  - » Steering lock is unlocked.
  - » Parking lights and all function circuits switched on.
  - » Pre-Ride-Check is carried out. (▶▶▶ 130)
- without riding modes Pro<sup>OE</sup>
  - » ASC self-diagnosis in progress. (▶▶▶ 131)◀
- with riding modes Pro<sup>OE</sup>
  - » DTC self-diagnosis is performed. (▶▶▶ 131)◀

## Switch off ignition

### Requirement

Radio-operated key is within reception range.

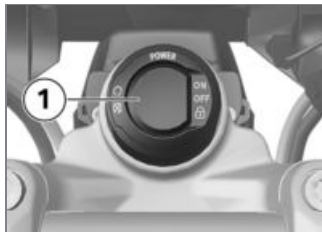

- The ignition can be deactivated in **two** ways.

### Version 1:

- Briefly press button **1**.
  - » Light is switched off.
  - » Handlebars are not locked.

### Version 2:

- Turn handlebars to left.
- Press and hold button **1**.
  - » Light is switched off.
  - » Steering lock is locked.

## EWS Electronic immobilizer

The motorcycle's electronic circuitry monitors the data stored in the radio-operated key through a ring antenna in the radio-operated lock. The engine management system does not enable engine starting until the radio-operated key has been recognized as "authorized" for your motorcycle.

### NOTICE

An additional key attached to the same ring as the radio-operated key used to start the engine could "irritate" the electronics, in which case the enabling signal for starting is not issued.

Always store further vehicle keys separately from the radio-operated key. ◀

If you lose a radio-operated key, you can have it disabled by your authorized BMW Motorrad retailer. When having a key disabled you should also bring all of the motorcycle's remaining keys with you.

The engine can no longer be started using a disabled radio-operated key; however, a disabled radio-operated key can be enabled again.

Emergency and spare keys are only available through an authorized BMW Motorrad retailer. As the radio-operated keys are part of an integrated security system, the retailer is under an obligation to check your legitimacy.

## Battery of radio-operated key is completely drained or radio-operated key has been lost

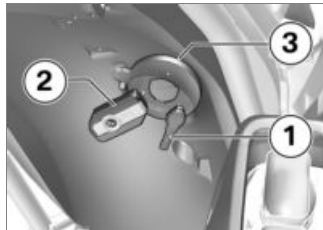

- Should you lose your keys, refer to the information regarding the electronic immobilizer (EWS) .
- Should you lose the radio-operated key while driving, the motorcycle can be started by using the emergency key.
- If the battery of the radio-operated key is completely drained, the motorcycle can be started by touching the rear wheel



cover with the radio-operated key.

- Hold emergency key **1** or completely drained radio-operated key **2** on rear wheel cover at level of antenna **3**.



## NOTICE

The emergency key or the drained radio-operated key must **contact** the rear wheel cover. ◀



Period in which the engine must be started. Then unlocking must be repeated.

30 s

- » Pre-Ride Check in progress.
- Key has been detected.
- Engine can be started.
- Starting engine (➡ 129).

## Replacing the battery of the key fob transmitter

If the key fob transmitter fails to react when the button is pressed briefly or is pressed and held:

- The battery of the key fob transmitter no longer has its full charging capacity.



Key remote battery low. Limited central locking function. Change battery.

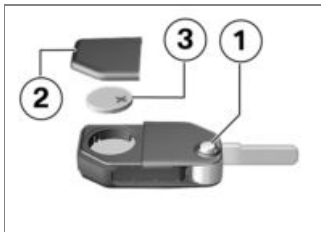

- Press button **1**.  
» Key bit folds open.
- Press battery cover **2** upward.

- Remove battery **3**.
- Dispose of the old battery in accordance with legal regulations. Do not dispose of the battery in the household waste.



## ATTENTION

### Unsuitable or improperly inserted batteries

Component damage

- Use a battery compliant with the manufacturer's specifications.
- When inserting the battery, make sure that the polarity is correct. ◀
- Insert the new battery with the positive terminal up.



Battery type

For Keyless Ride radio-operated key

CR 2032

- Install battery cover **2**.
- » Red LED in instrument panel flashes.
- » The key fob transmitter is working again.

## Emergency on/off switch (kill switch)



- 1** Emergency on/off switch (kill switch)



### WARNING

Operation of the emergency ON/OFF switch when riding

Danger of falling due to blocking of rear wheel

- Do not operate the emergency ON/OFF switch when riding. ◀

The engine can be switched off easily and quickly using the emergency on/off switch.

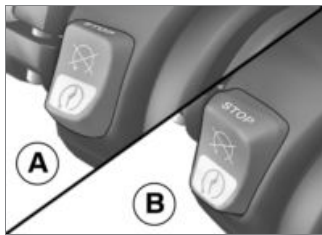

- A** Engine switched off  
**B** Operating position

## Lights

### Low-beam headlight and parking lights

The parking lights come on automatically when the ignition is switched on.



### NOTICE

The parking lights are a strain on the battery. Do not leave the ignition switched on longer than absolutely necessary. ◀

The low-beam headlight switches on automatically when the engine is started.

### High beam and headlight flasher

- Switching on ignition (▶▶ 58).



- Press switch **1** toward front to switch on high beam.
- Pull switch **1** toward rear to actuate headlight flasher.

### Parking lights

- Switch off ignition (➡ 59).



- Immediately after switching off the ignition, push button **1** to left and hold it until the parking lamps come on.
- Switch ignition on and then off again to switch off parking light.

### Additional headlight

– with LED additional headlight<sup>OA</sup>

### Requirement

The auxiliary headlights are only active if the low-beam headlight is active.



### NOTICE

The auxiliary headlights are approved for use as fog lights and may only be used in poor weather conditions. Comply with the country-specific road traffic regulations. ◀

- Starting engine (➡ 129).



- Press button **1** to turn on the additional headlight.



The indicator light for the additional headlight lights up.

- Press button **1** again to turn off the additional headlight.

## Hazard warning flashers

### Operating hazard warning flashers

- Switching on ignition (☛ 58).



#### NOTICE

The hazard warning flashers place a strain on the battery. Do not use the hazard warning flashers for longer than absolutely necessary. ◀



- Press button **1** to switch on the hazard warning lights system.
  - » Ignition can be switched off.
- To switch off the hazard warning lights system, switch on the ignition, as required, and press button **1** once again.

## Turn indicators

### Operating turn signals

- Switching on ignition (☛ 58).



- Press button **1** to left to switch on left-side turn signals.
- Press button **1** to right to switch on right-side turn signals.
- Move button **1** to center position to switch off turn signals.

## Comfort turn signals



When button **1** is pressed to the right or left, the turn signal automatically turns off under the following conditions:

- Speed is under 18 mph (30 km/h): after traveling a distance of 165 ft (50 m).
- Speed is between 18 mph and 60 mph (30 km/h and 100 km/h): after covering a particular distance depending on the speed or when accelerating.

- Speed is above 60 mph (100 km/h): after turn signal flashes five times.

When button **1** is pressed and held slightly longer to the right or left, the turn signals will only turn off automatically after reaching the distance depending on the speed.

## Antilock Braking System (ABS)

### Deactivating ABS function

- Switching on ignition (▶▶▶▶ 58).

### NOTICE

The ABS function can also be deactivated while driving.◀



- Press and hold button **1** until the ABS indicator and warning light changes its display behavior.

Immediately after pressing the button **1**, the current ASC/DTC system status and ABS system status ON are displayed.

- » First, the ASC indicator and warning light changes its behavior. Press and hold button **1** until the ABS indicator and warning light reacts. In this case, the ASC/DTC setting does not change.



ABS indicator light lights up.

Possible ABS system status OFF! is displayed.

- Release button **1** after changeover of the ABS system status.

ASC/DTC system status remains unchanged and new ABS system status OFF! is displayed for a short time.



ABS indicator light continues to be lit up.

- » The ABS function is switched off.
  - » The integral function is active again.
  - » The Hill Start Control function is active again.
- with riding modes Pro<sup>OE</sup>
- » The Hill Start Control Pro function is still active.<

- with riding modes Pro<sup>OE</sup>
  - » The Dynamic Brake Control function is turned off when the ABS function is turned off.<
- More information about braking systems with BMW Motorrad Integral ABS can be found in the section "Technology in detail":
  - » Partially integral brake (➡ 144)
  - » Hill Start Control function (➡ 156)
- with riding modes Pro<sup>OE</sup>
  - » Dynamic Brake Control function (➡ 152)<

## Switch on ABS function



- Press and hold button **1** until the ABS indicator and warning light changes its display behavior.

Immediately after pressing the button **1**, the current ASC/DTC system status and ABS system status OFF! are displayed.



ABS indicator light goes out, and starts to flash if self-diagnosis has not been completed.

Possible ABS system status ON is displayed.

- Release button **1** after changeover of the ABS system status.

 ABS indicator light remains off or continues to flash.

ASC/DTC system status remains unchanged and new ABS system status **ON** is displayed for a short time.

- » The ABS function is switched on.
- As an alternative, the ignition can also be turned off and then on again.



If the ABS indicator and warning light lights up after switching the ignition off and on and then continuing driving above the minimum speed, an ABS fault has occurred.

min 6 mph (min 10 km/h)

- with riding modes Pro<sup>OE</sup>
- If the coding plug is not installed, the ignition can also be turned off and then on again as an alternative.<

## Traction control (ASC/DTC)

### Switching the ASC/DTC function off

- Switching on ignition (→ 58).



#### NOTICE

The ASC/DTC function can also be deactivated while riding.<



- Press and hold button **1** until the ASC/DTC indicator and warning light changes its display behavior.

Immediately after pressing the button **1**, the ASC/DTC system status **ON** and current ABS system status are displayed.



ASC/DTC indicator and warning light lights up.

Possible ASC/DTC system status **OFF!** is displayed.

- Release button **1** after the ASC/DTC system status switches.

The new ASC/DTC system status OFF! is displayed for a short time. The ABS system status remains unchanged.

 ASC/DTC indicator and warning light remains illuminated.

» The ASC/DTC function is switched off.

### Switching the ASC/DTC function on



- Press and hold button **1** until the ASC/DTC indicator and

warning light changes its display behavior.

Immediately after pressing the button **1**, the ASC/DTC system status OFF! and current ABS system status are displayed.

 ASC/DTC indicator and warning light goes out; it begins to flash if self-diagnosis has not been completed.

Possible ASC system status ON is displayed.

- Release button **1** after changeover of the status.

 ASC indicator and warning light remains off or continues flashing.

Possible ASC/DTC system status ON is displayed.

» The ASC/DTC function is switched on.

– without riding modes Pro<sup>OE</sup>

- Alternatively, turn the ignition off and on again.<

– with riding modes Pro<sup>OE</sup>

- If the coding plug is not installed, the ignition can also be switched off and then on again as an alternative.

- More information about traction control (ASC/DTC) can be found in the "Technology in detail" chapter:

» How does traction control work? (➡ 147)

### Electronic chassis and suspension adjustment (D-ESA)

– with Dynamic ESA<sup>OE</sup>



## Dynamic ESA adjustment options

The Dynamic ESA electronic chassis and suspension adjustment can automatically adapt your motorcycle to the load. If the spring preload is set to **Auto**, the driver does not have to worry about adjusting the load.

More information about Dynamic ESA can be found in the "Technology in detail" chapter (➔ 149).

### Available damping modes

- For road use: Road and Dynamic
- For off-road use: Enduro

### Available load settings

- Fixed minimum spring preload: Min
- Active riding position compensation with automatic adjustment of spring preload: Auto

- Fixed maximum spring preload: Max

### NOTICE

BMW Motorrad recommends the **Auto** chassis and suspension adjustment. ◀

## Display suspension setting

- Switching on ignition (➔ 58).



- Press button **1** briefly to display current setting.

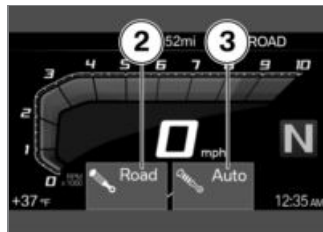

Immediately after pressing the button **1**, the chassis and suspension adjustments options for damping **2** and spring preload **3** are displayed.

» The display automatically disappears again after a short time.

## Setting suspension compliance

- Switching on ignition (➔ 58).



- Press button **1** briefly to display current setting.
- To set the damping rate:
- Repeatedly press button **1** briefly until the desired setting is displayed.



### NOTICE

The damping cannot be adjusted while the motorcycle is being ridden. ◀

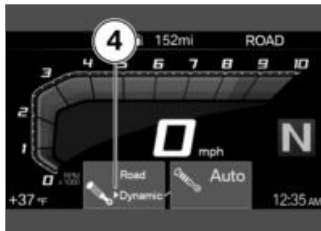

The selection arrow **4** is displayed.

» The selection arrow **4** goes away after the changeover of the status.

The following settings are available:

- Road: damping for comfortable road travel
- Dynamic: damping for dynamic road travel
- Enduro: damping for off-road riding. Only available in the riding modes ENDURO or ENDURO

PRO, and cannot be further adjusted in these riding modes.

The following message is displayed if no adjustments are possible in the selected riding mode: In ENDURO riding mode damp. not adjustable.



To set the spring preload:

- Starting engine (129).
- Repeatedly press and hold button **1** until the desired setting is displayed.

## NOTICE

BMW Motorrad recommends the **Auto** setting. **Min** can be used for easier dismounting and **Max**, for example, for off-road use.◀

## NOTICE

The settings **Min**, **Auto** and **Max** can only be selected while stationary.◀

The following message is displayed if no adjustments are possible: *Load adjust. only avail. when halted.*

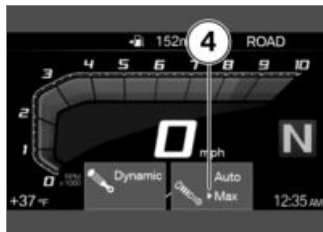

The selection arrow **4** is displayed.

» The selection arrow **4** goes away after the changeover of the status.

The following settings are available:

- **Min**: Minimum spring preload
- **Auto**: Automatic adjustment of the spring preload
- **Max**: Maximum spring preload

» If the button **1** is not pressed for an extended period, the damping action and the spring

preload will be adjusted to the displayed settings.

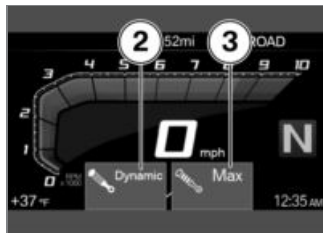

The new chassis and suspension adjustment options for damping **2** and spring preload **3** are displayed for a short period of time.

- At very low temperatures, unload the motorcycles before increasing the spring preload, and have the passenger dismount if necessary.
- » The chassis and suspension adjustment display goes away once the adjustment procedure has been completed.

» In the loading mode **Auto**, the spring preload is only adjusted after riding off.

## Riding mode

### Use of the riding modes

BMW Motorrad has developed riding scenarios for your motorcycle from which you can select the one matching your situation:

#### Series

- RAIN: Riding on rain-slicked roads.
- ROAD: Riding on dry roads.

– with riding modes Pro<sup>OE</sup>

### With pro riding modes

- DYNAMIC: Dynamic riding on dry roads.
- ENDURO: For off-road riding with road tires.

### With pro riding modes and integrated coding plug

- DYNAMIC PRO: Dynamic riding on dry roads, taking account of the settings by the driver.
- ENDURO PRO: Off-road riding with lugged off-road tires, taking account of the settings by the driver.

With an integrated coding plug, the riding modes **DYNAMIC PRO** and **ENDURO PRO** replace the riding modes **DYNAMIC** and **ENDURO**.

The optimum interaction between engine characteristics, ABS control, and ASC/DTC control is provided for each of these scenarios.

– with Dynamic ESA<sup>OE</sup>

The chassis and suspension adjustments can also be adapted in the selected scenario.

More detailed information about the riding modes can be found in the "Technology in detail" (►► 150) chapter.

### Select riding mode

- Switching on ignition (►► 58).



- Press button **1**.

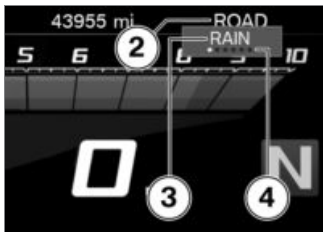

The active riding mode **2** fades into the background and the first selectable riding mode **3** is displayed. The guide **4** shows how many riding modes are available.



### **ATTENTION**

#### **Switching on off-road mode (ENDURO and ENDURO PRO) when riding on public roads**

Risk of falling due to unstable riding conditions when braking or accelerating in the ABS or ASC/DTC control range

- Switch on off-road mode (ENDURO and ENDURO PRO) during off-road riding only. ◀
- Press button **1** repeatedly until the desired riding mode is shown.

### **NOTICE**

In the factory setting, the ABS control for the rear wheel is deactivated when the ENDURO PRO riding mode is active. ◀

The following riding modes can be selected:

- RAIN: For riding on rain-slicked roads.
- ROAD: For riding on dry roads.

– with riding modes Pro<sup>OE</sup>

The following riding modes are additionally available for selection:

- DYNAMIC: For dynamic riding on dry roads.
- ENDURO: For off-road riding with road tires. ◀

– with riding modes Pro<sup>OE</sup>

With an integrated coding plug, the riding modes ENDURO PRO and DYNAMIC PRO replace

the riding modes **ENDURO** and **DYNAMIC**.

– **DYNAMIC PRO**: For dynamic riding on dry roads, taking account of the settings made by the rider.

– **ENDURO PRO**: For off-road riding with lugged off-road tires, taking account of the settings made by the rider.◀

- » When the motorcycle is stationary, the selected riding mode is activated after approx. 2 seconds.
- » The new riding mode is activated during operation under the following conditions:
  - Throttle grip is in idle position.
  - Brake is not engaged.
  - Cruise control is not active.
- » The riding mode selected and its associated engine-characteristic, ABS, ASC/DTC and Dynamic ESA settings are re-

tained even after the ignition has been switched off.

## PRO riding mode

– with riding modes Pro<sup>OE</sup>

### Adjustment option

The PRO riding modes can be set individually.

### Setting up the PRO riding mode

- Install coding plug (▶▶▶ 77).
- Switching on ignition (▶▶▶ 58).
- Call up menu **Settings, Vehicle settings**.
  - » The following PRO riding modes can be adjusted:
    - **ENDURO PRO** riding mode
    - **DYNAMIC PRO** riding mode
- Select and confirm the riding mode.

## Adjusting Enduro Pro

- with riding modes Pro<sup>OE</sup>
- Setting up the PRO riding mode (▶▶▶ 76).

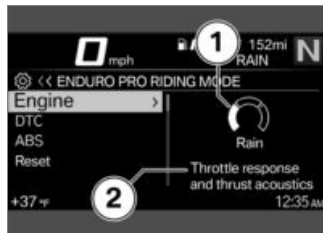

The **Engine** system is selected. The current setting is displayed as a diagram **1** with system descriptions **2**.

- Select and confirm the system.



You can browse through the possible settings **3** and the related descriptions **4**.

- Adjust the system.
  - » The Engine, DTC, and ABS systems can all be adjusted in the same way.
- The settings can be reset to factory settings:
- Resetting the riding mode settings (➡ 77).

## Adjust Dynamic Pro

- Setting up the PRO riding mode (➡ 76).
- Set systems as for ENDURO PRO riding mode.

## NOTICE

ABS can only be adjusted in ENDURO PRO riding mode.◀

## Resetting the riding mode settings

- Setting up the PRO riding mode (➡ 76).
- Select *Reset* and confirm.
  - » The following factory settings apply for ENDURO PRO RIDING MODE:
    - DTC: Enduro Pro
    - ABS: Enduro Pro
    - ENGINE: Road
  - » The following factory settings apply for DYNAMIC PRO RIDING MODE:
    - DTC: Dynamic
    - ENGINE: Dynamic

## Install coding plug

- Switch off ignition (➡ 59).

- Remove rider's seat (➡ 88).



## ATTENTION

### Penetration of dirt and moisture in the open connector

Malfunctions

- After removing the encoding plug, refit the cover cap.◀
- Remove the cover cap from the plug connection **1**.



- To do this, push in the lock **1** and pull off the cap.
- Insert the coding plug.
- Switch on the ignition.

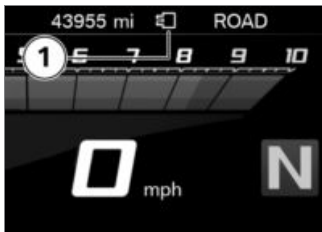

The symbol for the encoding plug **1** is displayed. The riding modes **ENDURO PRO** and

**DYNAMIC PRO** can be selected and replace the riding modes **ENDURO** and **DYNAMIC**.

- Install rider's seat (→ 90).

## Cruise-control system

– with cruise control<sup>OE</sup>

### Display while adjusting (road sign detection not active)



The symbol **1** for the cruise control is displayed in the Pure Ride view and in the upper status line.

### Display while adjusting (road sign detection active)



The symbol **1** for the cruise control is displayed in the Pure Ride view and in the upper status line.

### Switch on cruise control Requirement

Speed control is only available after switching from the **ENDURO** or **ENDURO PRO** riding modes.





- Slide switch **1** to the right.
- » Button **2** is unlocked.

### Store speed



- Short-press button **1** forward.



Adjustment range for  
cruise control

19...130 mph (30...210 km/h)



Cruise-control indicator light  
lights up.

- » The motorcycle maintains your current cruising speed and the setting is saved.

### Accelerating

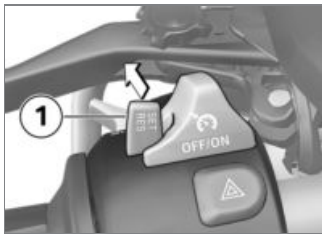

- Short-press button **1** forward.
- » Speed is increased by 1 mph (1.6 km/h) each time the button is pressed.

- Press button **1** forward and hold.
- » The motorcycle accelerates with infinite variability (no steps).
- » If button **1** is no longer pressed, the speed reached is maintained and saved.

### Decreasing speed

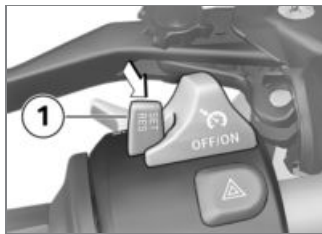

- Briefly press button **1** backward.
- » Speed is reduced by 1 mph (1.6 km/h) each time the button is pressed.
- Press button **1** back and hold.

- » The motorcycle decelerates with infinite variability (no steps).
- » If button **1** is no longer pressed, the speed reached is maintained and saved.

## Deactivate cruise control

- Operate brakes, coupling or throttle grip (ease the throttle beyond the default setting) to deactivate the cruise control.

### NOTICE

When changing gear using the Pro Gear-shift Assistance function, the cruise-control system is automatically deactivated for safety reasons.◀

### NOTICE

With ASC and DTC interventions, the cruise-control system is automatically deactivated for safety reasons.◀

- » Cruise-control indicator light goes out.

## Resuming former cruising speed

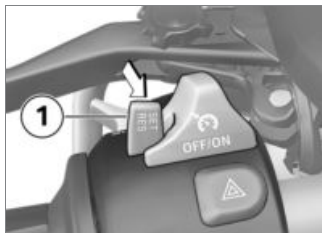

- Briefly push button **1** back to return to the speed saved beforehand.

### NOTICE

Opening the throttle does not deactivate the cruise-control system. If you release the throttle grip, the motorcycle will decelerate only to the cruising speed saved in memory, even though

you might have intended slowing to a lower speed.◀

 Cruise-control indicator light lights up.

## Switch off cruise control

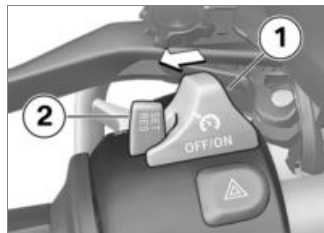

- Push switch **1** to left.
  - » The system is deactivated.
  - » Button **2** is locked.

## Hill Start Control Display

– with riding modes Pro<sup>OE</sup>

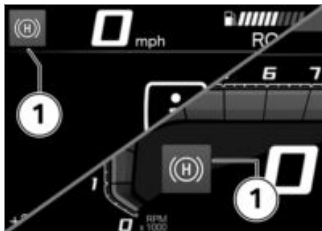

The symbol **1** for the drive-off assistant is displayed in the Pure Ride view and in the upper status line.◀

## Using Hill Start Control Requirement

The vehicle is at a standstill.

### ATTENTION

#### Drive-off assistant failure

Accident hazard

- Manually brake to secure the vehicle.◀

### NOTICE

Hill Start Control is only a convenience system for easier hill-starting and should, therefore, not be confused with a parking brake.◀

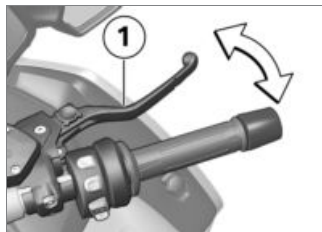

- Apply handbrake lever **1** or footbrake lever firmly and then release again.

 Green stop symbol is displayed.

- » Hill Start Control is activated.
- To switch off the Hill Start Control, activate the handbrake

lever **1** or the footbrake lever again.

 Stop symbol disappears.

- Alternatively, drive off in 1st or 2nd gear.

### NOTICE

Hill Start Control is deactivated automatically when driving off.◀

 The stop symbol disappears after the brake has been released completely.

- » Hill Start Control is deactivated.
- More information about Hill Start Control can be found in the section "Technology in detail":
- » Hill Start Control function (▣▣▣ 156)

## Switch Hill Start Control on and off

- Switching on ignition (▣▣▣ 58).

- Call up menu Settings, Vehicle settings.
- Turn Hill Start Control on or off.

## Using Hill Start Control Pro

– with riding modes Pro<sup>OE</sup>

### ATTENTION

#### Drive-off assistant failure

Accident hazard

- Manually brake to secure the vehicle.◀

### NOTICE

Hill Start Control Pro is only a comfort system to make starting on hills easier and should therefore not be confused with a parking brake.◀

### NOTICE

Hill Start Control Pro drive-off assistant should not be used for gradients of more than 40%.◀

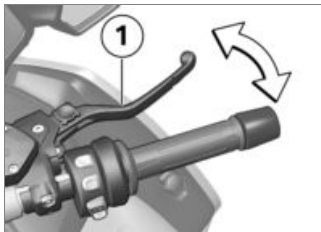

- Apply handbrake lever **1** or footbrake lever firmly and then release again.
- Alternatively, apply the brake for about one second after the vehicle has come to a standstill, with a gradient of at least 5%.



Green stop symbol is displayed.

» Hill Start Control Pro is now activated.

- To switch off Hill Start Control Pro, activate the handbrake lever **1** or the footbrake lever again.

### NOTICE

If Hill Start Control Pro is deactivated using the brake lever, automatic Hill Start Control is deactivated for the next 4 m.◀



Stop symbol disappears.

- Alternatively, drive off in 1st or 2nd gear.

### NOTICE

Hill Start Control Pro is deactivated automatically when driving off.◀



The stop symbol disappears after the brake has been released completely.

- » Hill Start Control Pro is now deactivated.
- More information about Hill Start Control Pro can be found in the section "Technology in detail":
- » Hill Start Control function (▣▣▣ 156)

## Adjust Hill Start Control Pro

– with riding modes Pro<sup>OE</sup>

- Switching on ignition (▣▣▣ 58).
- Call up menu `Settings, Vehicle settings`.
- Select `Hill Start Control Pro`.
- To turn off Hill Start Control Pro, select `Off`.
- » Hill Start Control Pro is deactivated.
- To turn on manual Hill Start Control Pro, select `Manual`.

- » Hill Start Control Pro can be activated by firmly applying the handbrake or footbrake lever.
- To turn on automatic Hill Start Control Pro, select `Auto`.
- » Hill Start Control Pro can be activated by firmly applying the handbrake or footbrake lever.
- » When applying the brake for approximately one second after the vehicle has come to a standstill and on a slope with at least a 5% gradient, Hill Start Control Pro is activated automatically.
- » The selected setting is retained even after the ignition is turned off.

## Anti-theft alarm system (DWA)

### Activation

- with anti-theft alarm system (DWA)<sup>OE</sup>
  - Switching on ignition (▣▣▣ 58).
  - Adjust DWA (▣▣▣ 86).
  - Turn off ignition.
  - » If DWA is activated, DWA is automatically activated after the ignition is switched off.
  - » Activation takes approximately 30 seconds to complete.
  - » Turn indicators are illuminated twice.
  - » Confirmation tone sounds twice (if programmed).
  - » The anti-theft alarm system is active.

– with Keyless Ride<sup>OE</sup>

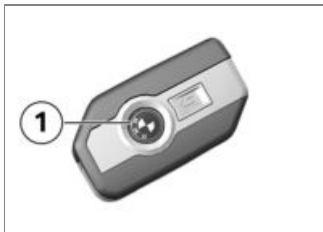

- Turn off ignition.
- Press button **1** on the radio-operated key twice.
  - » Activation takes approximately 30 seconds to complete.
  - » Turn indicators are illuminated twice.
  - » Confirmation tone sounds twice (if programmed).
  - » The anti-theft alarm system is active.

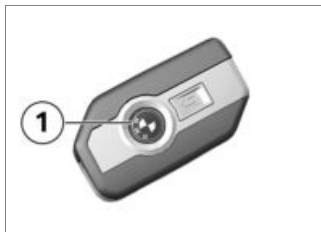

- To deactivate the movement sensor (for example if you are about to transport the motorcycle on a train and the swaying movement of the moving train could trip the alarm), press button **1** on the radio-operated key during the activation phase.
  - » Turn signals are illuminated three times.
  - » Confirmation tone sounds three times (if programmed).
  - » Movement sensor is deactivated.

## Alarm signal

– with anti-theft alarm system (DWA)<sup>OE</sup>

The DWA alarm can be set off by:

- Motion sensor
- Switch-on attempt with an unauthorized ignition key.
- Disconnecting the DWA from the motorcycle battery (DWA battery takes over the power supply – alarm sound only, hazard warning lights do not flash).

If the DWA battery is discharged all functions remain operational; the only difference is that the alarm cannot be set off if the system is disconnected from the motorcycle battery.

The duration of the alarm is approx. 26 seconds. During the alarm, an alarm tone sounds and the turn indicators flash. The type of alarm sound can be set

by an authorized BMW Motorrad retailer.

– with Keyless Ride<sup>OE</sup>

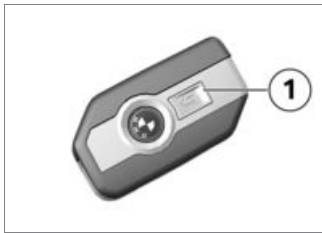

A triggered alarm can be canceled at any time by pressing the button **1** on the radio-operated key without deactivating the DWA.

If an alarm was triggered while the motorcycle was unattended, the rider is notified accordingly by an alarm tone sounding once when the ignition is switched on. The DWA LED then signals

the reason for the alarm for one minute.

### Light signals on DWA LED:

- 1 flash: motion sensor 1
- 2 flashes: motion sensor 2
- 3 flashes: ignition turned on with unauthorized ignition key
- 4 flashes: alarm system disconnected from vehicle battery
- 5 flashes: motion sensor 3

### Deactivation

- with anti-theft alarm system (DWA)<sup>OE</sup>
  - Emergency on/off switch (kill switch) in normal operating position.
  - Switch on the ignition.
    - » Turn indicators light up once.
    - » Confirmation tone sounds once (if programmed).
    - » DWA is switched off.

– with Keyless Ride<sup>OE</sup>

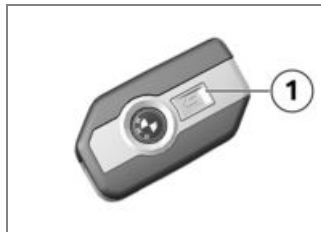

- Press button **1** on the radio-operated key once.

### NOTICE

If the alarm function is deactivated using the radio-operated key and the ignition is not then switched on, it will reactivate automatically after 30 seconds if "activation after ignition off" is programmed.◀

- » Turn indicators light up once.
- » Confirmation tone sounds once (if programmed).
- » DWA is switched off.

## Adjust DWA

- Switching on ignition (▶▶▶ 58).
  - Call up menu **Settings**, **Vehicle settings**, **Alarm system**.
- » The following settings are available:
- Adjust **Warning signal**
  - Turn **Tilt sensor** on and off
  - Turn **Arming tone** on and off
  - Turn **Arm automatically** on and off
  - with anti-theft alarm system (DWA)<sup>OE</sup>
- » Adjustment options (▶▶▶ 86)◀

## Adjustment options

- with anti-theft alarm system (DWA)<sup>OE</sup>

**Warning signal:** Set rising and falling or intermittent alarm tone.

**Tilt sensor:** Activate the inclination sensor to monitor the inclination of the vehicle. The anti-

theft alarm system responds if, for example, if the wheel is stolen or the motorcycle is towed.



### NOTICE

Deactivate the tilt sensor when transporting the vehicle to avoid triggering the DWA.◀

**Arming tone:** Confirmation alarm tone after activating/deactivating the DWA in addition to flashing turn indicators.

**Arm automatically:** Automatic activation of the alarm function when turning off the ignition.

## Tire Pressure Monitor (TPM)

- with riding modes Pro<sup>OE</sup>

## Switching the minimum pressure warning on or off

- The minimum pressure of the tires can be freely selected.

When the minimum pressure is reached, a minimum pressure warning can be displayed.

- Call up menu **Settings**, **Vehicle settings**, **RDC**.
- Turn **Nom. pressure warning** on or off.

## Heated handlebar grips

- with heated grips<sup>OE</sup>

## Operating heated grips



### NOTICE

The heated grips option can only be activated when the engine is running.◀



### NOTICE

The increase in power consumption caused by the heated grips can drain the battery if you are riding at low engine speeds. If the battery is inadequately charged, the heated



grips are switched off to ensure starting capability. ◀

- Starting engine (▶▶ 129).

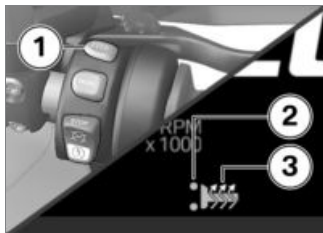

- Press the button **1** repeatedly until the desired heating level **2** is shown in front of the heated grip symbol **3**.

The handlebar grips can be heated at two different levels.



50 % heating output



100 % heating output

- » The 2nd heating level is used for fast heat-up of the grips; then the switch should be switched back to the 1st level.
- » If no further changes are made the selected heating level is adopted as the setting.
- To switch off the heated grips, press the button **1** repeatedly until the heated grip symbol **3** goes out.

## Rider and passenger seats

### Remove passenger seat

- Remove rider's seat (▶▶ 88).

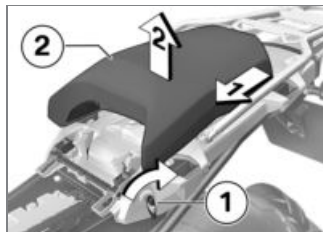

- Turn ignition key **1** clockwise.
- Slide pillion seat **2** forwards and lift up to remove
- Place pillion seat on clean surface with the fabric side facing down.

## Installing passenger seat

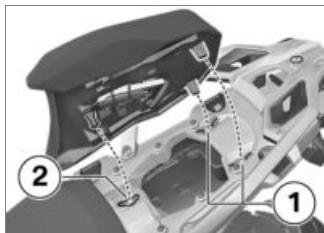

- Fit passenger seat centered in rear mounts **1** and in front mount **2**.
- Slide pillion seat to the rear.
- Check pillion seat is properly located.

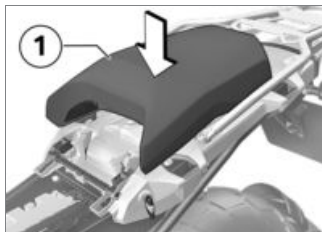

- Firmly press pillion seat **1** downwards.
  - » Passenger seat clicks audibly into place.
- Install rider's seat (⇒ 90).

## Remove rider's seat

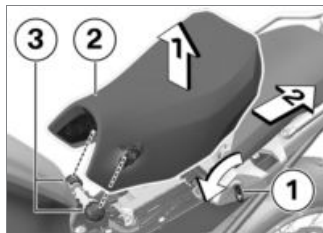

- Turn vehicle key **1** counter-clockwise and hold while lifting driver's seat **2** in rear area.
- Remove driver's seat **2** from seat bracket **3** toward rear.
- Lay driver's seat on a clean surface with the upholstered side down.

## Adjusting the seat height and seat angle

- Remove rider's seat (⇒ 88).

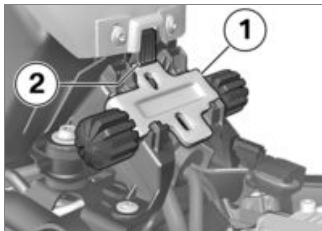

- To remove the front height adjustment **1** push the lock **2** forwards and remove the height adjustment in an upwards direction.

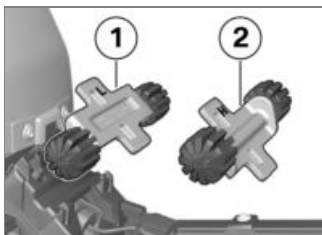

- To adjust the low seat position, install the front height adjust-

ment in direction **1** (identification L).

- To adjust the high seat position, install the front height adjustment in direction **2** (identification H).

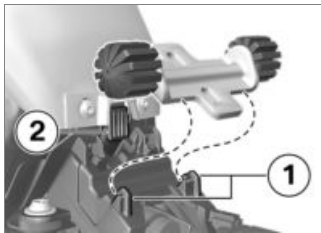

- First, slide the front height adjustment under the mounts **1**. Then press into locking mechanism **2** until it engages.

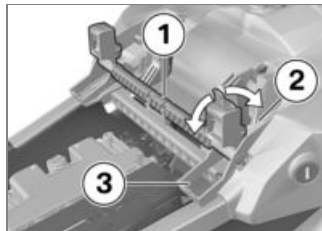

- In order to adjust the low seat position, swivel the rear height adjustment **1** into position **3** (identification L).
- In order to adjust the low seat position, swivel the rear height adjustment **1** into position **2** (identification H).

If seat tilt should be changed:

- Position the front and rear height adjustment differently.
- Install rider's seat (→ 90).

## Install rider's seat

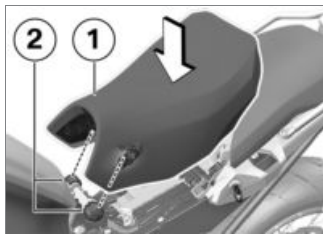

- Fit front seat **1** into seat mount **2** on left and right and place loosely on motorcycle.
- Press rider's seat slightly forward in rear area and then firmly downward until locking mechanism engages.

## Storage compartment

### Opening and locking the storage compartment

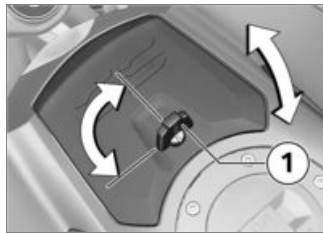

- To open the storage compartment **1**, turn the handle through 90° in a counter-clockwise direction and pull it up.
- To lock the storage compartment **1**, close the storage compartment, turn the handle through 90° in a clockwise direction, and fold it onto the storage compartment in the driving direction.

## **TFT display**

General notes.....	92
Principle .....	93
Pure Ride view.....	99
General settings .....	101
Bluetooth .....	102
My vehicle .....	105
Navigation .....	108
Media.....	110
Phone .....	110
Display software version .....	111
Display license information.....	111

## General notes

### Warnings



#### WARNING

#### Operation of a smartphone while riding or with the engine running

Accident hazard

- Observe the relevant road traffic regulations.
- Do not use while riding (except for applications without operation such as telephony via the hands-free system).◀



#### WARNING

#### Distraction from traffic conditions and loss of control

Risk of accident through the use of integrated information systems and communication devices during the journey

- Operate these systems or devices only if the traffic situation allows.
- If necessary, stop and operate the system or devices at a standstill.◀

### Connectivity functions

Connectivity functions include media, telephony and navigation. Connectivity functions can be used if the TFT display is connected with a mobile end device and a helmet (📞➔ 102). You can find more information about the Connectivity functions at: **[bmw-motorrad.com/connectivity](http://bmw-motorrad.com/connectivity)**



#### NOTICE

If the fuel tank is between the mobile end device and the TFT display, the Bluetooth connection may be restricted. BMW Motorrad recommends

storing the mobile end device above the fuel tank (e.g. in the jacket pocket).◀



#### NOTICE

Depending on the mobile end device, the scope of the Connectivity functions may be limited.◀

### BMW Motorrad Connected App

With the BMW Motorrad Connected App, you can call up information about the vehicle and usage. To use some features such as navigation, the app must be installed on the mobile end device and be connected to the TFT display. The app starts the route guidance and adapts the navigation.



## NOTICE

On some mobile devices, e.g. with operating system iOS, the BMW Motorrad Connected App must be called up before using. ◀

### Notice concerning current status

After the editorial deadline, there may be updates to the TFT display. For this reason, some aspects of your motorcycle may vary from the descriptions in this Rider's Manual. Updated information at: [bmw-motorrad.com](http://bmw-motorrad.com)

## Principle Operating elements

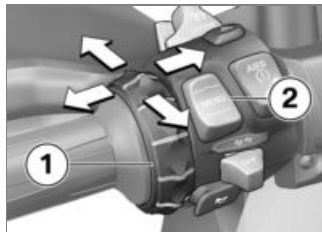

All contents of the display are controlled by the Multi-Controller **1** and the rocker button MENU **2**.

The following functions are possible depending on the context.

### Functions of the Multi-Controller

#### Turn the Multi-Controller up:

- Move cursor up in lists.
- Make settings.
- Increase volume.

#### Turn the Multi-Controller down:

- Move cursor down in lists.
- Make settings.
- Reduce volume.

#### Tilt Multi-Controller to the left:

- Activate the function according to the operating feedback.
- Activate function to the left or back.
- After settings, return to menu view.
- In the menu view: move up one hierarchy level.
- In the My Vehicle menu: leaf to the next menu sheet.

#### Tilt Multi-Controller to the right:

- Activate the function according to the operating feedback.
- Confirm selection.
- Confirm settings.
- Leaf to the next menu step.

- Scroll to right in lists.
- In the My Vehicle menu: leaf to the next menu sheet.

## Rocker button MENU functions

### NOTICE

Navigation instructions are displayed as a dialog if the Navigation menu has not been called up. Operation of the MENU rocker button is temporarily restricted.◀

### Briefly press the MENU up:

- In the menu view: move up one hierarchy level.
- In the Pure Ride view: change display for rider info status line.

### MENU long press up:

- In the menu view: open Pure Ride view.

- In the Pure Ride view: change the operating focus to the navigator.

### MENU short press down:

- Change a hierarchy level down.
- No function when lowest hierarchy level is reached.

### MENU long press down:

- Return to the last menu, after a menu change has been previously carried out by long press of the rocker button MENU at the top.

## Operating instructions in the main menu

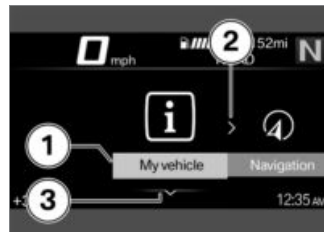

The operating instructions indicate whether and which interactions are possible.



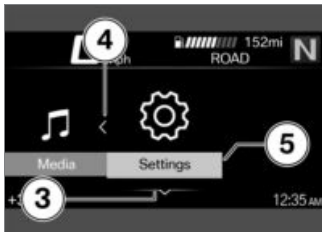

### Meaning of the operating instructions:

- Operating instruction **1**: the left end has been reached.
- Operating instruction **2**: you can leaf to the right.
- Operating instruction **3**: you can leaf down.
- Operating instruction **4**: you can leaf to the left.
- Operating instruction **5**: the right end has been reached.

### Operating instructions in submenus

In addition to the operating instructions in the main menu, there are additional operating instructions in submenus.

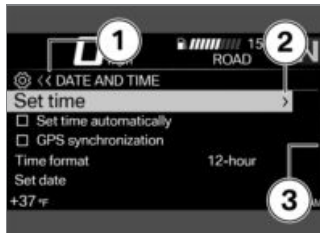

### Meaning of the operating instructions:

- Operating instruction **1**: the current display is in a hierarchical menu. One symbol indicates a submenu level. Two symbols indicate two or more submenu levels. The color of the symbol changes depending

on whether it is possible to return to the top.

- Operating instruction **2**: another submenu level can be called up.
- Operating instruction **3**: there are more entries than can be displayed.

### Show Pure Ride view

- Long-press the top rocker button MENU.

## Switching functions on and off



Some items are preceded by a box. The box indicates whether the function is switched on or off. Action symbols after the menu items illustrate what is switched by briefly tilting the Multi-Controller to the right.

### Examples for switching on and off:

- Symbol **1** indicates that the function is switched on.
- Symbol **2** indicates that the function is switched off.

- Symbol **3** indicates that the function can be switched off.
- Symbol **4** indicates that the function can be switched on.

## Calling up the menu

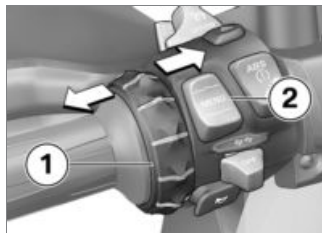

- Show Pure Ride view (▬▬▬▬ 95).
- Briefly press button **2** downward.

The following menus can be called up:

- My vehicle
- Navigation
- Media
- Telephone
- Settings

- Press Multi-Controller **1** repeatedly briefly to the right until the desired menu item is marked.
- Briefly press button **2** downward.



## NOTICE

The Settings menu can only be called up when stationary. ◀

## Moving the cursor in lists

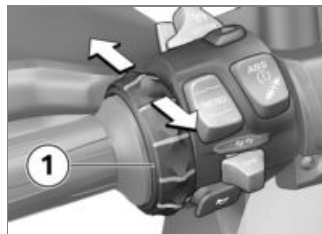

- Calling up the menu (▬▬▬▬ 96).
- To move the cursor down in lists, turn the Multi-Controller **1**

down until the desired entry is marked.

- To move the cursor up in lists, turn the Multi-Controller **1** up until the desired entry is marked.

## Confirming the selection



- Select desired entry.
- Multi-Controller **1** short press to right.

## Calling up the last menu used

- In the Pure Ride view: rocker button MENU long press down.

- » The last used menu is called up. The last marked entry is selected.

## Operating focus change

- with preparation for navigation system<sup>OE</sup>

When the Navigator is connected, you can switch between the operation of the Navigator and the TFT display.

## Changing the operating focus

- with preparation for navigation system<sup>OE</sup>

- Securely fasten navigation device (►► 195).
- Show Pure Ride view (►► 95).
- Long-press the top rocker button MENU.
- » Operating focus changes to the Navigator or the TFT display. The active device is marked in the upper left status line.

Operating actions affect the active device until the operating focus is changed again.

- » Operating the navigation system (►► 197)

## System status displays

The system status is displayed in the lower menu area when a function has been switched on or off.

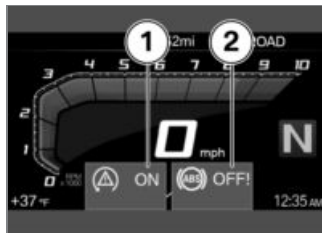

## Examples of the meaning of the system statuses:

- System status **1**: ASC/DTC function is switched on.

- System status **2**: ABS function is switched off.

## Changing the display for rider info status line

### Requirement

The vehicle is at a standstill. The Pure Ride view is displayed.

- Switching on ignition (▶▶ 58).
  - » All of the information necessary for operating the vehicle on public roads is made available from the on-board computer (e.g. TRIP **1**) and the travel on-board computer (e.g. TRIP **2**) in the TFT display. The information can be displayed in the upper status line.
- with tire pressure monitor (TPM)<sup>OE</sup>
  - » In addition, information from the Tire Pressure Monitor can be displayed.<

- Select content of driver info. status line (▶▶ 99).



- Long press button **1** to display the Pure Ride view.
- Press button **1** briefly to select the value in the upper status line **2**.

The following values can be displayed:

- Odometer *Total*
- Trip distance 1 TRIP 1
- Trip distance 2 TRIP 2

 Average consumption 1

 Average consumption 2

 Driving time 1

 Driving time 2

 Break 1

 Break 2

 Average speed 1

 Average speed 2

 Tire inflation pressure

 Fuel gage

 Range

## Select content of driver info. status line

- Call up menu **Settings**, **Display**, **Status line content**.
- Turn on desired displays.
  - » It is possible to change between the selected displays in the driver info. status line. If no displays are selected, only the range is shown.

## Making settings



- Select desired settings menu and confirm.

- Turn Multi-Controller **1** down until the desired setting is marked.
- If an operating instruction is present, tilt Multi-Controller **1** to the right.
- If no operating instruction is present, tilt Multi-Controller **1** to the left.
  - » The setting is saved.

## Switch Speed Limit Info on or off

### Requirement

Vehicle is connected to a compatible mobile terminal. The BMW Motorrad Connected app is installed on the mobile terminal.

- **Speed Limit Info** displays the currently permitted top speed.
- Call up menu **Settings**, **Display**.

- Switch **Speed Limit Info** on or off.

## Pure Ride view

### Tachometer

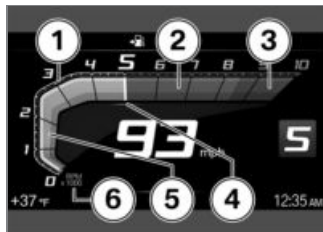

- 1** Scale
- 2** Low engine speed range
- 3** High / red engine speed range
- 4** Needle
- 5** Drag pointer
- 6** Unit for tachometer: 1000 RPM

**NOTICE**

The red engine speed range changes depending on the coolant temperature:

The colder the engine, the lower the speed at which the red engine speed range begins.

The warmer the engine, the higher the speed at which the red engine speed range begins. When the operating temperature has been reached, the red engine speed range display will no longer change.

The upshift recommendation is adjusted dynamically as well. ◀

## Range



The range **1** indicates how far you can ride with the remaining fuel. This distance is calculated on the basis of average consumption and the quantity of fuel on board.

- When the motorcycle is propped on its side stand the slight angle of inclination means that the sensor cannot register the fuel level correctly. For this reason, the range is only recalculated when the side stand is folded in.

- The range is displayed together with a warning once the fuel reserve is reached.
- After refueling, the range is recalculated if the fuel quantity is greater than the fuel reserve.
- The calculated range is only an approximate figure.

## Upshift recommendation



Upshift recommendation **1** signals the economically best point in time for upshifting.

## General settings

### Adjusting the volume

- Connect the rider's helmet and the passenger helmet (▮▮▮▮ 104).
- Increase volume: turn Multi-Controller up.
- Reduce volume: turn Multi-Controller down.
- Mute: turn Multi-Controller all the way down.

### Set date

- Switching on ignition (▮▮▮▮ 58).
- Call up menu **Settings, System settings, Date and time, Set date.**
- Set **Day, Month, and Year.**
- Confirm setting.

### Adjust date format

- Call up menu **Settings, System settings, Date and time, Date format.**
- Select desired setting.
- Confirm setting.

### Set clock

- Switching on ignition (▮▮▮▮ 58).
- Call up menu **Settings, System settings, Date and time, Set time.**
- Set **Hour and Minute.**

### Adjust time format

- Call up menu **Settings, System settings, Date and time, Time format.**
- Select desired setting.
- Confirm setting.

### Switch GPS synchronization on or off

- with preparation for navigation system<sup>OE</sup>
- Call up menu **Settings, System settings, Date and time.**
- Turn **GPS synchronization on or off.**
  - » When the corresponding option is activated in the Navigator,

the time is taken from the Navigator.

» Special functions (▮▮▮▮ 200)

### Adjust units of measurement

- Call up menu **Settings, System settings, Units.**
- The following units of measurement can be set:
- Distance covered
  - Pressure
  - Temperature
  - Consumption

### Adjust language

- Call up menu **Settings, System settings, Language.**
- The following languages can be set:
- Chinese
  - German
  - English
  - Spanish
  - French

- Italian
- Dutch
- Portuguese
- Russian
- Ukrainian
- Polish
- Turkish

### Adjusting brightness

- Call up menu `Settings`, `Display`, `Brightness`.
- Adjust brightness.

### Reset all settings

- All settings in the `Settings` menu can be reset to the factory settings.
- Call up menu `Settings`.
- Select `Reset all` and confirm.

The settings of the following menus are reset:

- `Vehicle settings`
- `System settings`
- `Connections`
- `Display`

- `Information`

- » Existing Bluetooth connections are not deleted.

## Bluetooth

### Short-range radio technology

The Bluetooth function may not be offered depending on the country of use.

Bluetooth is a short-range radio technology. Bluetooth devices are short-range devices (transmitting with a limited range) on the license-free ISM band (Industrial, Scientific, Medical) between 2.402 GHz and 2.480 GHz. They can be operated anywhere in the world without requiring a license. Although Bluetooth is designed to establish robust links over a short distance, disturbances are possible, as they are with any wireless technology. Links may

be disturbed, interrupted briefly or lost entirely. Especially when several devices are operated in one Bluetooth network, there is no guarantee for smooth operation in every situation.

### Possible sources of interference:

- Interference fields due to transmission towers and similar.
- Devices with incorrectly implemented Bluetooth standard.
- By nearby Bluetooth-capable devices.

### Pairing

Before two Bluetooth devices can be linked to one another, they must recognize each other. This process of mutual recognition is known as pairing. When two devices have paired they remember each other, so the pairing process is conducted only once, on initial contact.





## NOTICE

On some mobile devices, e.g. with operating system iOS, the BMW Motorrad Connected App must be called up before using. ◀

During the pairing process, the TFT display searches for other Bluetooth-compatible devices within its reception range. The conditions that have to be satisfied before the audio system can recognize another device are as follows:

- The Bluetooth function of the device must be activated
- The device must be "visible" to others
- The device must support the A2DP profile
- Other Bluetooth-capable devices must be OFF (e.g. mobile phones and navigation systems).

Please consult the operating instructions for your communication system.

### Perform pairing

- Call up menu **Settings, Connections**.
  - » Bluetooth connections can be established, managed, and deleted in the **CONNECTIONS** menu. The following Bluetooth connections are displayed:

- Mobile device
- Rider's helmet
- Passeng. helmet

The connection status for mobile end devices is displayed.

### Connect mobile end device

- Perform pairing (▶▶▶▶ 103).
- Activate the Bluetooth function of the mobile end device (see operating instructions for the mobile end device).

- Select **Mobile device** and confirm.
- Select **PAIR NEW MOBILE DEVICE** and confirm.

Mobile end devices are searched for.



During the pairing, the Bluetooth symbol flashes in the lower status line.

Visible mobile end devices are displayed.

- Select the mobile end device and confirm.
- Observe the instructions for the mobile end device.
- Confirm that the codes match.
  - » The connection is established and the connection status is updated.
  - » If the connection cannot be established, the troubleshooting chart in the "Technical data" chapter may provide assistance. (▶▶▶▶ 209)

- » Depending on the mobile end device, telephone data is transferred to the vehicle automatically.
- » Telephone data (▶▶▶ 111)
- » If the phone book is not displayed, the troubleshooting chart in the "Technical data" chapter may provide assistance. (▶▶▶ 210)
- » If the Bluetooth connection does not work as expected, the troubleshooting chart in the "Technical data" chapter may provide assistance. (▶▶▶ 209)

### Connect the rider's helmet and the passenger helmet

- Perform pairing (▶▶▶ 103).
- Select `Rider's helmet` or `Passeng. helmet` and confirm.
- Show the communication system of the helmet.

- Select `PAIR NEW RIDER'S HELMET` or `PAIR NEW PASS. HELMET` and confirm.

Helmets are searched for.



During the pairing, the Bluetooth symbol flashes in the lower status line.

Visible helmets are displayed.

- Select helmet and confirm.
- » The connection is established and the connection status is updated.
- » If the connection cannot be established, the troubleshooting chart in the "Technical data" chapter may provide assistance. (▶▶▶ 209)
- » If the Bluetooth connection does not work as expected, the troubleshooting chart in the "Technical data" chapter may provide assistance. (▶▶▶ 209)

### Delete connections

- Call up menu `Settings, Connections`.
- Select `Delete connections`.
- To delete an individual connection, select the connection and confirm.
- To delete all connections, select `Delete all connections` and confirm.

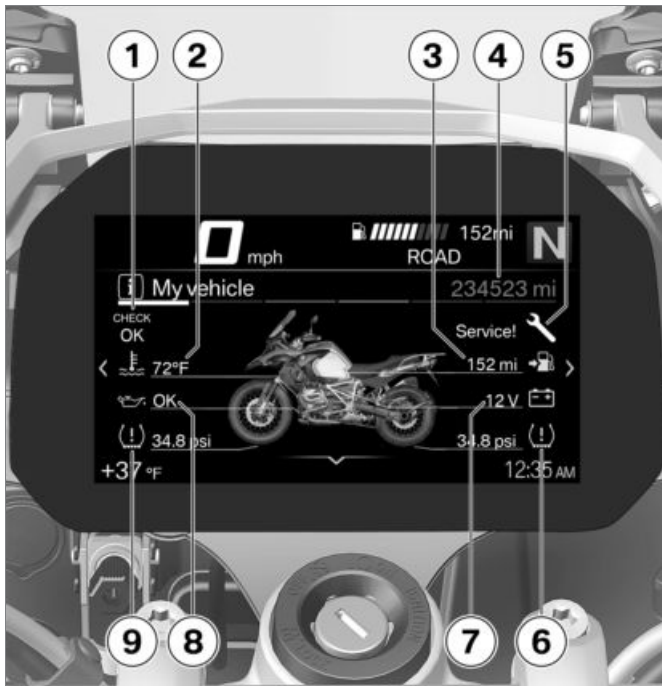

## My vehicle

### Start screen

- 1 Check Control display Display (➡ 28)
- 2 Coolant temperature (➡ 43)
- 3 Range (➡ 100)
- 4 Total mileage
- 5 Service display (➡ 54)
- 6 Rear tire pressure (➡ 44)
- 7 Vehicle voltage (➡ 182)
- 8 Engine oil level (➡ 42)
- 9 Front tire pressure (➡ 44)

## Operating instructions

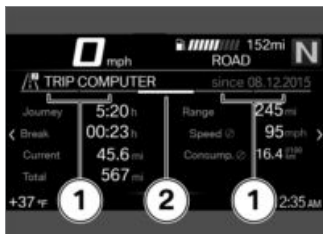

- Operating instruction **1**: tab that shows how far to the left or right you can leaf.
- Operating instruction **2**: tab that shows the position of the current menu screen.

## Scroll through menu windows

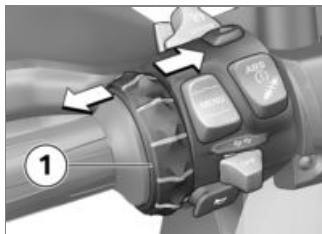

- Call up menu *My vehicle*.
- To scroll to the right, briefly push the Multi-Controller **1** to the right.
- To scroll to the left, briefly push the Multi-Controller **1** to the left.

The "My vehicle" menu contains the following windows:

- MY VEHICLE
- CC messages (if available)
- ONBOARD COMPUTER
- TRIP COMPUTER

- with tire pressure monitor (TPM)<sup>OE</sup>
- TIRE PRESSURE<
- SERVICE REQUIREMENTS
- Further information on the tire pressure and CC messages can be found in the section "Displays".

### NOTICE

Check Control messages are dynamically added as additional tabs to the menu screens in the *My Vehicle* menu.◀

### On-board computer and travel on-board computer

The ONBOARD COMPUTER and TRIP COMPUTER menu windows show the vehicle and journey data, e.g. average values.

### Call up on-board computer

- Call up menu *My vehicle*.

- Scroll to the right until the ON-BOARD COMPUTER menu window is displayed.

## Reset on-board computer

- Call up on-board computer (▣▣▣▶ 106).
- Press MENU rocker button down.
- Select `Reset all values` or `Reset individual values` and confirm.

The following values can be reset individually:

- Break
- Journey
- Current (TRIP 1)
- Ø speed
- Ø consump.

## Call up travel on-board computer

- Call up on-board computer (▣▣▣▶ 106).

- Scroll to the right until the TRIP COMPUTER menu window is displayed.

## Reset travel on-board computer

- Call up travel on-board computer (▣▣▣▶ 107).
- Press MENU rocker button down.
- Select `Automatic reset` or `Reset all` and confirm.
- » If `Automatic reset` has been selected, the travel on-board computer is automatically reset if at least 6 hours have passed since the ignition was turned off and the date has changed.

## Service display

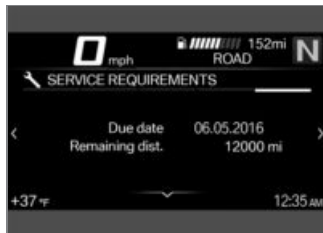

If the time remaining until the next service is less than a month, or if the next service is due within 700 miles (1,000 km), a white CC message is displayed.

## Navigation

### Warnings



#### WARNING

#### Operation of a smartphone while riding or with the engine running

Accident hazard

- Observe the relevant road traffic regulations.
- Do not use while riding (except for applications without operation such as telephony via the hands-free system).◀



#### WARNING

#### Distraction from traffic conditions and loss of control

Risk of accident through the use of integrated information systems and communication devices during the journey

- Operate these systems or devices only if the traffic situation allows.
- If necessary, stop and operate the system or devices at a standstill.◀

### Prerequisite

The vehicle is connected to a compatible mobile end device.

The BMW Motorrad Connected App is installed on the mobile end device.



#### NOTICE

On some mobile devices, e.g. with operating system iOS, the BMW Motorrad Connected App must be called up before using.◀

### Enter destination address

- Connect mobile end device (▶▶▶▶ 103).

- Call up the BMW Motorrad Connected app and start the route guidance.
- Call up menu **Navigation** in the TFT display.
  - » Active route guidance is displayed.
  - » If the active route guidance is not displayed, the troubleshooting chart in the "Technical data" chapter may provide assistance. (▶▶▶▶ 210)

### Select destination from most recent destinations

- Call up menu **Navigation**, **Recent destinations**.
- Select destination and confirm.
- Select **Start route guidance**.

### Select destination from favorites

- The **FAVORITES** menu shows all destinations that have been saved as a

favorite in the BMW Motorrad Connected app. It is not possible to create new favorites on the TFT display.

- Call up menu `Navigation, Favorites`.
- Select destination and confirm.
- Select `Start guidance`.

### Enter special destination

- Special destinations, e.g. landmarks, can be displayed on the map.
- Call up menu `Navigation, POIs`.

The following locations can be selected:

- `At current location`
- `At destination`
- `Along the route`
- Select the area to look for special destinations.

E.g. the following special destination can be selected:

- `Filling station`

- Select special destination and confirm.
- Select `Start route guidance` and confirm.

### Define route criteria

- Call up menu `Navigation, Route criteria`.
- The following criteria can be selected:
- `Route type`
  - `Avoid`

- Select desired `Route type`.
  - Turn desired `Avoid` on or off.
- The number of enabled avoidances is displayed in brackets.

### End route guidance

- Call up menu `Navigation, Active route guidance`.
- Select `End route guidance` and confirm.

### Switch spoken directions on or off

- Connect the rider's helmet and the passenger helmet (▶▶▶▶▶▶ 104).
- The navigation can be read out by a computer voice. To do this, the `Spoken instructions` must be turned on.
- Call up menu `Navigation, Active route guidance`.
- Turn `Spoken instructions` on or off.

### Repeat last spoken directions

- Call up menu `Navigation, Active route guidance`.
- Select `Current spoken instruction` and confirm.

## Media

### Prerequisite

The vehicle is connected to a compatible mobile end device and a compatible helmet.

### Control music playback

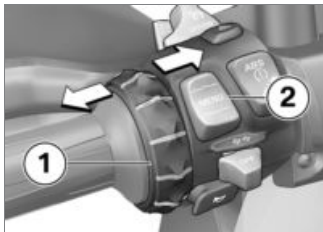

- Call up menu **Media**.

#### NOTICE

BMW Motorrad recommends setting the volume for media and conversations via mobile end devices to the maximum before starting a journey. ◀

- Adjusting the volume (▬▶ 101).
- Next title: Tilt the Multi-Controller **1** briefly to the right.
- Last title or start of current title: Tilt the Multi-Controller **1** briefly to the left.
- Fast forward: Tilt and hold the Multi-Controller **1** to the right.
- Fast rewind: Tilt and hold the Multi-Controller **1** to the left.
- Call up context menu: Press button **2** down.

#### NOTICE

Depending on the mobile end device, the scope of the Connectivity functions may be limited. ◀

- » The following functions can be used in the context menu:
  - Start playback or Pause playback.
  - For search and playback, select the category **Now playing**, **All artists**, **All albums**, or **All tracks**.

- Select **Playlists**.

In the **Audio options** submenu you can adjust the following settings:

- Turn **Shuffle** on or off.
- Repeat: Select **Off**, **One** (current track), or **All**.

## Phone

### Prerequisite

The vehicle is connected to a compatible mobile end device and a compatible helmet.



## Make a phone call



- Call up menu **Telephone**.
- Accept telephone call: Tilt the Multi-Controller **1** to the right.
- Reject telephone call: Tilt the Multi-Controller **1** to the left.
- End telephone call: Tilt the Multi-Controller **1** to the left.

## Muting

The microphone in the helmet can be muted during active conversations.

## Conversations with multiple users

A second telephone call can be accepted during a conversation. The first conversation will be put on hold. The number of active telephone calls is displayed in the **Telephone** menu. It is possible to switch between two conversations.

## Telephone data

Depending on the mobile end device, telephone data will be automatically transferred to the vehicle after the pairing (▶▶▶ 102).

**Phone book:** List of contacts saved in the mobile end device

**Call list:** List of telephone calls with the mobile end device

**Favorites:** List of favorites saved in the mobile end device

## Display software version

- Call up menu **Settings, Information, Software version**.

## Display license information

- Call up menu **Settings, Information, Licenses**.



## Setting

Mirrors .....	114
Headlight .....	115
Windshield .....	116
Clutch .....	116
Brakes .....	117
Shifting .....	120
Footrests .....	121
Handlebars .....	122
Spring preload .....	123
Damping .....	124

## Mirrors

### Adjust mirrors



- Move mirror into desired position by twisting.

### Adjust mirror arm

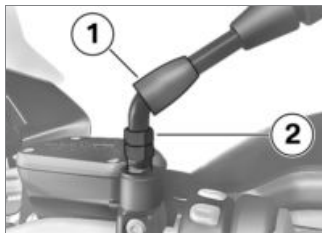

- Slide protective cap **1** up over screw connection on mirror arm.
- Loosen the nut **2**.
- Turn mirror arm into desired position.
- Tighten the nut to the specified torque while holding the mirror arm to ensure that it does not move out of position.



Mirror (locknut) on adapter

16 lb/ft (22 Nm) (Left-hand thread)

- Slide protective cap over threaded fastener.

### Adjusting mirrors

- with Option 719 Milled Parts Set Classic<sup>OE</sup>
- or
- with Option 719 Milled Parts Set Storm<sup>OE</sup>
- or
- with HP machined-parts package<sup>OE</sup>



### NOTICE

To adjust the mirror arm, a small and a large angle screwdriver are included with the vehicle. ◀

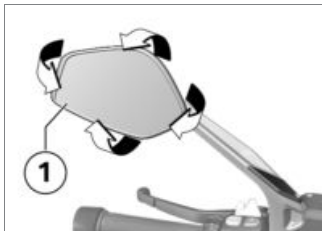

- Move mirror **1** into desired position by turning it.

### Adjusting mirror arm

- with Option 719 Milled Parts Set Classic<sup>OE</sup>
- or
- with Option 719 Milled Parts Set Storm<sup>OE</sup>
- or
- with HP machined-parts package<sup>OE</sup>

### NOTICE

To adjust the mirror arm, a small and a large angle screwdriver are included with the vehicle. ◀

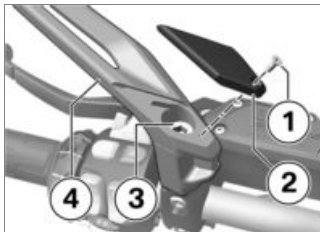

- Remove screw **1** and remove cover **2**.
- Loosen adjusting screw **3** and turn mirror arm **4** into the desired position.
- Tighten adjusting screw **3**, holding the mirror arm while doing so.
- Affix cover **2** and install screw **1**.



Mirror on handlebars

18 lb/ft (25 Nm)

## Headlight

### Headlamp range and spring preload

The headlamp range generally remains constant due to the adjustment of the spring preload to the loading state.

Spring preload adjustment may only be insufficient when the motorcycle is very heavily loaded. In this case, the headlamp range must be adjusted to the weight.

### NOTICE

If there are doubts as to the correct headlight range, have the adjustment checked by a specialized workshop, preferably by

an authorized BMW Motorrad retailer. ◀

## Headlight range adjustment

### Requirement

When the spring pretension adjustment is no longer able to maintain the correct beam height to avoid blinding oncoming traffic owing to high vehicle loads:

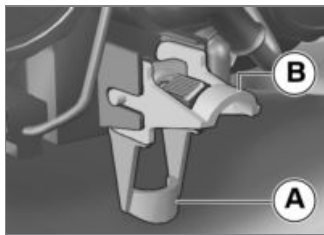

- The headlight range is adjusted using a swiveling lever.
- **A** Neutral position
- **B** Position at high payload

## Windshield

### Adjusting windshield



**WARNING**

### Adjusting the windshield while driving

Accident hazard

- Only adjust the windshield when the motorcycle is stationary. ◀

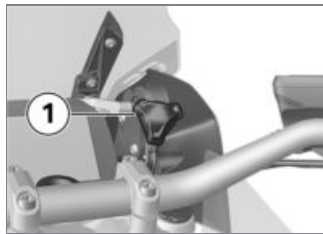

- Turn the adjustment wheel **1** clockwise to lower the windshield.

- Turn the adjustment wheel **1** counter-clockwise to raise the windshield.

## Clutch

### Adjusting clutch lever



**WARNING**

### Adjusting the clutch lever while driving

Accident hazard

- Adjust the clutch lever when the motorcycle is stationary. ◀

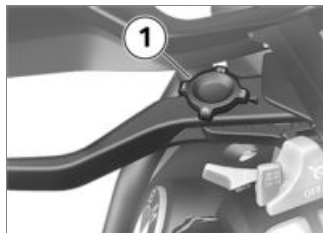

- Turn the adjustment wheel **1** into the desired position.

## NOTICE

The adjustment wheel can be turned more easily if you press the clutch lever forward when doing so.◀

- » Four settings are available:
- Position 1: smallest distance between handlebar grip and clutch lever
- Position 4: largest distance between handlebar grip and clutch lever

– with Option 719 Milled Parts Set Classic<sup>OE</sup>

or

– with Option 719 Milled Parts Set Storm<sup>OE</sup>

or

– with HP machined-parts package<sup>OE</sup>

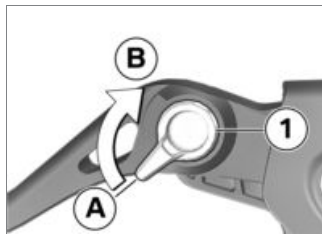

- Turn the adjustment lever **1** to the desired position.
- » Adjustment options:
- From position **A**: smallest distance between handlebar grip and clutch lever.
- Five steps toward position **B** to increase the distance be-

tween the handlebar grip and the clutch lever.◀

## Brakes

### Adjust brake lever

#### WARNING

#### Adjusting the brake lever while driving

Accident hazard

- Only adjust the brake lever when the motorcycle is stationary.◀



- Turn the adjustment wheel **1** into the desired position.

 **NOTICE**

The adjustment wheel can be turned more easily if you press the handbrake lever forward when doing so. ◀

- » Four settings are available:
- Position 1: smallest distance between handlebar grip and brake lever
  - Position 4: largest distance between handlebar grip and handbrake lever

– with Option 719 Milled Parts Set Classic<sup>OE</sup>

or

– with Option 719 Milled Parts Set Storm<sup>OE</sup>

or

– with HP machined-parts package<sup>OE</sup>

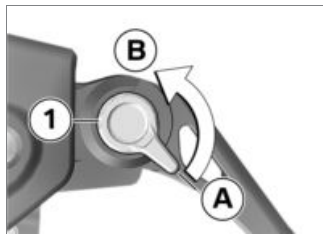

- Turn the adjustment lever **1** to the desired position.
- » Adjustment options:
  - From position **A**: smallest distance between handlebar grip and handbrake lever.
  - Five steps toward position **B** to increase the distance be-

tween the handlebar grip and the handbrake lever. ◀

### Adjusting footbrake lever

- Make sure ground is level and firm and park motorcycle.

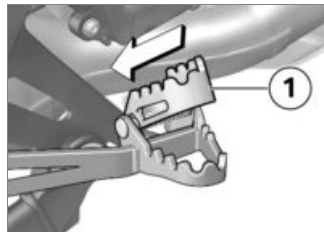

- Slide treadplate **1** of footrest sideways to the left to unlock.





- Fold step plate upward up to detent when riding while seated.

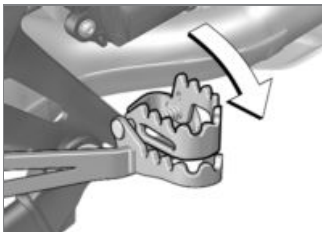

- Fold step plate downward down to detent when riding while standing.

## Adjusting the footbrake lever foot piece

– with Option 719 Milled Parts Set Classic<sup>OE</sup>

or

– with Option 719 Milled Parts Set Storm<sup>OE</sup>

or

– with HP machined-parts package<sup>OE</sup>

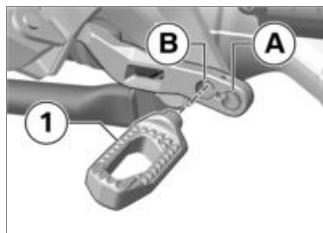

- The distance between the feet and the height of the foot piece **1** can be adjusted by turning them by 180° and in-

stalling them in position **A** or **B**.

- Remove screw **1**.

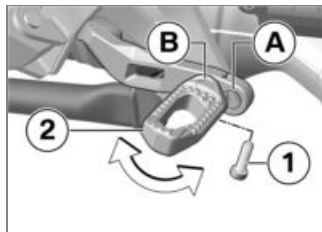

- Clean the thread.
- Install the foot piece **2** in the desired position **A** or **B**.
- Turn the foot piece **2** into the desired position.
- Install the **new** screw **1**.



Foot piece on footbrake lever

Thread-locking compound:  
micro-encapsulated

7 lb/ft (10 Nm)

## Shifting

### Adjusting shift lever

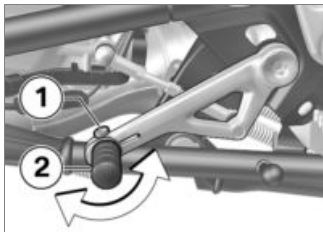

- Slacken screw **1**.
- Turn foot piece **2** into desired position.

#### NOTICE

If the toe piece is set too high or too low, this can cause problems when shifting gears. In the event of shifting problems, check the toe piece setting. ◀

- Tighten screw **1** to specified torque.



Treadplate (fixing) on gear lever

6 lb/ft (8 Nm)

### Adjusting gearshift lever foot piece

- with Option 719 Milled Parts Set Classic<sup>OE</sup>
- or
- with Option 719 Milled Parts Set Storm<sup>OE</sup>
- or
- with HP machined-parts package<sup>OE</sup>

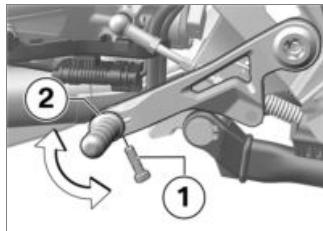

- The distance between the feet and the height of the foot piece **2** can be adjusted by turning the foot piece into different positions.
- Remove screw **1**.

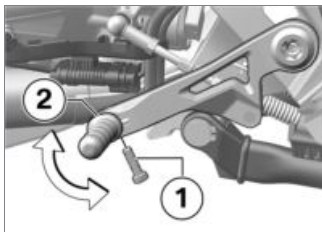

- Clean the thread.
- Turn the foot piece **2** into the desired position.
- Install the **new** screw **1**.

 Foot piece to gearshift lever

Thread-locking compound:  
micro-encapsulated

7 lb/ft (10 Nm)

## Footrests

- with Option 719 Milled Parts Set Classic<sup>OE</sup>
- or
- with Option 719 Milled Parts Set Storm<sup>OE</sup>
- or
- with HP machined-parts package<sup>OE</sup>

### Adjust footrests

- The footrest is adjusted the same way when moving it right or left.
- The position of the footrest must be set equally on the right and left.

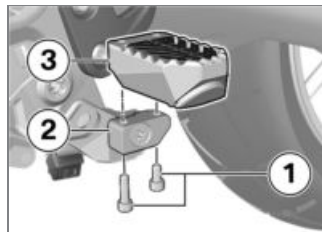

- Remove screws **1**.
- Remove the footrest **3** from the clamping block **2**.

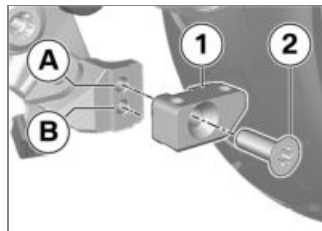

- Remove screw **2**.
- Remove clamping block **1**.

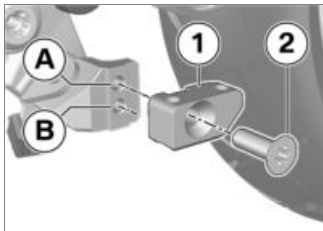

- Install clamping block **1** in the desired position **A** or **B** and tighten screw **2**.

 Clamping block on footrest hinge

15 lb/ft (20 Nm)

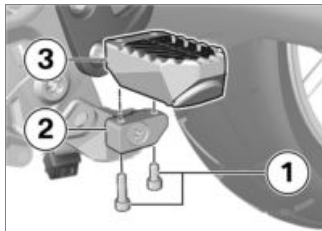

- Position footrest **3** on clamping block **2**.
- Install screws **1**.

 Footrest on clamping block

7 lb/ft (10 Nm)

- Remove and install the footrest on the other side in the same way.

## Handlebars

### Adjustable handlebars

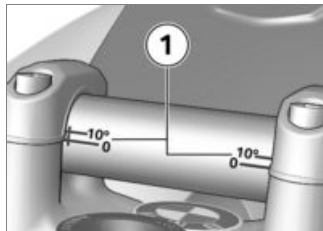

The inclination of the handlebars is adjustable in the areas with the mark **1**.

Have the handlebars adjusted by a specialist workshop, preferably an authorized BMW Motorrad retailer.

## Spring preload

### Setting

– without Dynamic ESA<sup>OE</sup>

It is essential to set the spring preload to suit the load carried by the motorcycle. Increase spring preload when the vehicle is heavily loaded and reduce spring preload accordingly when the vehicle is lightly loaded.

### Adjusting spring preload at rear wheel

- Park the motorcycle, ensuring that the support surface is firm and level.



### **WARNING**

#### **Uncoordinated settings of spring preload and spring strut damping.**

Poorer handling.

- Adjust damping characteristic to changed spring preload.◀

### **WARNING**

#### **Adjusting the spring preload while riding.**

Accident hazard

- Adjust the spring preload only when the motorcycle is stationary.◀
- To increase the spring preload, turn the adjustment wheel **1** in the direction of the arrow HIGH.
- To decrease the spring load, turn the adjustment wheel **1** in the direction of the arrow LOW.



Basic setting of spring preload, rear

– without Dynamic ESA<sup>OE</sup>

Turn adjustment wheel as far as possible into LOW direction. (One-up without load)

Turn adjuster wheel as far as possible in LOW direction, then rotate 15 turns in HIGH direction. (One-up with load)



Basic setting of spring preload, rear

Turn adjuster wheel as far as possible in LOW direction, then rotate 30 turns in HIGH direction. (Two-up and load)◀

## Damping

– without Dynamic ESA<sup>OE</sup>

### Setting

The damping must be adjusted to the road conditions and the spring preload.

- A rough road surface requires softer damping than a smooth road surface.
- An increase in spring preload requires firmer damping, a reduction in spring preload requires softer damping.

## Adjusting damping on rear wheel

- Park the motorcycle, ensuring that the support surface is firm and level.
- Adjust damping from the left side of the vehicle.

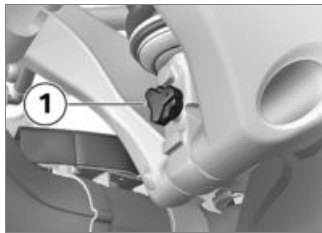

- To increase damping, turn adjustment screw **1** clockwise.
- To decrease damping, turn adjustment screw **1** counterclockwise.



Basic setting of rear wheel damping

Turn adjustment wheel as far as possible clockwise, then 8 clicks counterclockwise. (One-up without load)

Turn adjustment wheel as far as possible clockwise, then 4 clicks counterclockwise. (One-up with load)

Turn adjustment wheel as far as possible clockwise, then 4 clicks counterclockwise. (Two-up with load)

## **Riding**

Safety information .....	126
Observe checklist.....	128
Before every journey: .....	128
At every third refueling stop.....	129
Starting .....	129
Breaking in.....	132
Off-road use .....	133
Shifting gears .....	134
Brakes .....	135
Parking your motorcycle .....	137
Refueling .....	137
Securing motorcycle for transportation .....	141

## Safety information

### Rider's Equipment

Do not ride without the correct clothing. Always wear:

- Helmet
- Rider's suit
- Gloves
- Boots

This applies even to short journeys, and to every season of the year. Your authorized BMW Motorrad Dealer will be happy to advise you and has the correct clothing for every purpose.

### Reduced clearance in inclined position

Motorcycles with lowered running gear have less ground clearance in all positions than motorcycles with standard running gear.



### WARNING

#### When cornering with lowered motorcycles, motorcycle parts can contact the road surface sooner than normal.

Accident hazard

- Carefully test the clearance of the motorcycle in an inclined position and adjust your riding style accordingly. ◀

Test the clearance of your motorcycle at an angle in safe situations. Remember to take the limited ground clearance of your motorcycle into account when driving over curbs and similar obstacles.

The lowering of the motorcycle shortens the spring travel (see the chapter "Technical Data"). A possible reduction in the accustomed driving comfort may result. Especially when riding with

a passenger, the spring preload should be adjusted accordingly.

### Load



### WARNING

#### Reduced riding stability caused by overloading and uneven loading

Accident hazard

- Do not exceed the gross weight limit and observe the loading information. ◀
- Adjust spring preload and damping rate for the current gross vehicle weight.
- Ensure that case volumes on left and right are equal.
- Make sure that weight is uniformly distributed between right and left.
- Pack heavy pieces of luggage and cargo as low and as close to the center of the motorcycle as possible.



- Observe the maximum payload and maximum speed as indicated on the label in the case (see also the chapter "Accessories").
- Observe the maximum payload and maximum speed as indicated on the label in the topcase (see also the chapter "Accessories").
- with tank bag<sup>OA</sup>
- Observe maximum payload of tank rucksack.



Payload of tank rucksack

max 11 lbs (max 5 kg)◀

## Speed

If you ride at high speed, always bear in mind that various boundary conditions can adversely affect the handling of your motorcycle:

- Settings of spring-strut and shock absorber system
- Unevenly distributed load
- Loose clothing
- Insufficient tire inflation pressure
- Tire tread in poor condition
- Etc.

## Maximum speed with studded or winter tyres



**DANGER**

### Maximum speed of the motorcycle is higher than the permissible maximum rated speed of the tires.

Risk of accident due to tire damage at high speed.

- Observe the maximum permissible speed for the tyres.◀

With studded or winter tyres, the maximum permissible speed for the tyres must be observed.

Attach a label specifying the maximum permissible speed in the field of view of the instrument cluster.

## Risk of poisoning

Exhaust fumes contain carbon monoxide, which is colorless and odorless but highly toxic.



**WARNING**

### Harmful exhaust gas

Danger of suffocation

- Do not inhale exhaust fumes.
- Do not run the engine in closed rooms.◀

## Burn hazard

**CAUTION**

### Intense heating up of engine and exhaust system while riding

Burn hazard

- After parking the motorcycle, make sure that no persons or objects come into contact with the engine and exhaust system.◀

### Catalytic converter

If misfire causes unburned fuel to enter the catalytic converter, there is a danger of overheating and damage.

The following must be observed:

- Do not run the fuel tank dry.
- Do not run the engine with the spark-plug cap removed.
- Stop the engine immediately if it misfires.
- Use unleaded fuel only.

- Comply with all specified maintenance intervals.

**ATTENTION**

### Unburned fuel in the catalytic converter

Damage to catalytic converter

- Note the points listed for protection of the catalytic converter.◀

### Danger of overheating

**ATTENTION**

### Engine idling for a lengthy period while at a standstill

Overheating due to insufficient cooling; in extreme cases vehicle fire

- Do not allow the engine to idle unnecessarily.
- After starting, ride off immediately.◀

## Modifications

**ATTENTION**

### Modifications to the motorcycle (e.g. engine control unit, throttle valves, clutch)

Damage to the affected parts, failure of safety-relevant functions, expiration of warranty

- Do not make any modifications.◀

### Observe checklist

- Use the following checklist to check your motorcycle at regular intervals.

### Before every journey:

- Check operation of the brake system.
- Check operation of the lighting and signal system.
- Check clutch function (▶▶▶ 168).

- Checking tire tread depth (☞ 170).
- Checking tyre pressure (☞ 169).
- Check secure hold of cases and luggage.

## At every third refueling stop

- Checking the engine oil level (☞ 162).
- Checking the front brake pad thickness (☞ 164).
- Checking rear brake pad thickness (☞ 165).
- Check front brake fluid level (☞ 166).
- Checking rear brake fluid level (☞ 167).
- Checking coolant level (☞ 168).

## Starting

### Starting engine

- Switch on the ignition.
  - » Pre-Ride-Check is carried out. (☞ 130)
    - without riding modes Pro<sup>OE</sup>
    - » ASC self-diagnosis in progress. (☞ 131)◀
  - with riding modes Pro<sup>OE</sup>
    - » DTC self-diagnosis is performed. (☞ 131)◀
- Engage neutral, or pull back clutch lever if a gear is engaged.

### NOTICE

You cannot start the motorcycle with the side stand extended and a gear engaged. The engine will switch itself off if it is started with the transmission in neutral and then a gear is engaged before retracting the side stand.◀

- In the case of cold start or under cold temperatures: Pull back clutch lever.



- Press starter button **1**.

### NOTICE

The starting attempt is automatically interrupted if battery voltage is too low. Recharge the battery before you attempt to start the engine again, or use jumper cables and a donor battery to start. More detailed information can be found in the "Maintenance" chapter under "Jump-starting".◀

- » Engine starts.
- » If the engine fails to start, the troubleshooting table in the chapter "Technical Data" may provide assistance. (▶▶▶ 208)

## Pre-Ride-Check

After switching on the ignition, the instrument cluster performs a test of the indicator and warning lights – the so-called "Pre-Ride-Check". Starting the engine before the test routine is completed will cancel the remainder of the routine.

### Phase 1

All indicator and warning lights are switched on.

After a longer standstill of the vehicle, an animation is displayed during the system start.

### Phase 2

The general warning light switches from red to yellow.

## Phase 3

All switched on indicator and warning lights are switched off one after the other in reverse order.

If one of the indicator and warning lights does not switch on:

- Have the malfunction corrected as soon as possible at an authorized specialist workshop, preferably an authorized BMW Motorrad retailer.

## ABS self-diagnosis

The self-diagnosis routine checks whether the BMW Motorcycle Integral ABS is ready for operation. The self-diagnosis routine runs automatically when you switch on the ignition. To check the wheel speed sensors, the motorcycle must be driven a few meters at a minimum speed of 3 mph (5 km/h).

## Phase 1

- » Check on system components monitored by the diagnostic system while motorcycle is parked.



ABS indicator light flashes.

## Phase 2

- » Check wheel sensors while starting off.



ABS indicator light flashes.

## ABS self-diagnosis completed

- » ABS warning light goes out.
  - Check the display of all indicator and warning lights.
- An ABS error is indicated following completion of the ABS self-diagnosis routine.
- It remains possible to continue riding. Please be aware that

neither the ABS nor the integral function are available.

- Have the malfunction corrected as soon as possible at an authorized service facility, preferably an authorized BMW Motorrad Retailer.

## ASC self-diagnosis

– without riding modes Pro<sup>OE</sup>

The self-diagnosis routine checks whether the BMW Motorcycle ASC is ready for operation. The self-diagnosis routine runs automatically when you switch on the ignition.

### Phase 1

- » Check on system components monitored by the diagnostic system while motorcycle is parked.



ASC indicator and warning light flashes slowly.

### Phase 2

- » Checking the diagnosable system components while the motorcycle is moving (at least 3 mph [5 km/h]).



ASC indicator and warning light flashes slowly.

### ASC self-diagnosis completed

- » The ASC indicator and warning light goes out.

- Check the display of all indicator and warning lights.

If an ASC error is indicated following completion of the ASC self-diagnosis routine:

- It remains possible to continue riding. Please be aware that ASC functionality is no longer available.
- Have the malfunction corrected as soon as possible at an authorized service facility,

preferably an authorized BMW Motorrad Retailer.

## DTC self-diagnosis

– with riding modes Pro<sup>OE</sup>

The self-diagnosis routine is determining whether BMW Motorrad DTC is ready for operation. The self-diagnosis routine runs automatically when you switch on the ignition.

### Phase 1

- » Check on system components monitored by diagnostic system while motorcycle is parked.



DTC indicator and warning light flashes slowly.

### Phase 2

- » Checks diagnosis-capable system components when motorcycle starts to move.



DTC indicator and warning light flashes slowly.

## DTC self-diagnosis completed

- » The DTC symbol is no longer displayed.
- Check the display of all indicator and warning lights.



DTC self-diagnosis not completed

The DTC function is not available, as the self-diagnosis function has not been completed. (To check wheel speed sensors, motorcycle must reach a minimum speed with engine running: min 3 mph (min 5 km/h))

If an DTC error is displayed after the DTC self-diagnosis is completed:

- It remains possible to continue riding. It must be noted

that the availability of the DTC function is restricted or it is not available at all.

- Have the malfunction corrected as soon as possible at an authorized service facility, preferably an authorized BMW Motorrad Retailer.

## Breaking in

### Engine

- While running in the motorcycle, vary the throttle opening and engine-speed range frequently; avoid driving for long periods at a constant speed.
- Choose curvy, slightly hilly sections of road if possible.
- Observe the engine run-in speeds.



Engine break-in speeds

<5000 min<sup>-1</sup> (Mileage 0...621 miles (0...1000 km))



Engine break-in speeds

No full throttle (Mileage 0...621 miles (0...1000 km))

- Observe mileage, after which the running-in check should be performed.



Mileage until running-in check

311...746 miles (500...1200 km)

## Brake pads

New brake pads must be run in before they achieve their optimum friction force. This initial reduction in braking efficiency can be compensated for by exerting greater pressure on the brake levers.

 **WARNING**

**New brake pads**

Extension of the braking distance, accident hazard

- Brake early.◀

**Tires**

New tires have a smooth surface. This must be roughened by riding in a restrained manner at various heel angles until the tires are run in. This running in procedure is essential if the tires are to achieve maximum grip.

 **WARNING**

**Loss of adhesion of new tires on wet roads and at extreme angles**

Accident hazard

- Always think well ahead and avoid extreme angles.◀

**Off-road use**

**After driving offroad**

BMW Motorrad recommends that the following be observed after driving offroad:

**Tire pressure**

 **WARNING**

**When driving off-road, lower tire pressure than riding on paved roads**

Risk of accident due to poorer handling characteristics.

- Ensure proper tire inflation pressure.◀

**Brakes**

 **WARNING**

**Riding on unpaved or dirty roads**

Delayed braking effect due to dirty brake discs and brake pads

- Brake early until the brakes are clean again.◀

 **ATTENTION**

**Riding on unpaved or dirty roads**

Increased brake pad wear

- Check the brake pad thickness more often and replace the brake pads sooner.◀

**Spring preload and damping**

 **WARNING**

**Modified values for spring preload and spring strut damping when riding off-road**

Poorer handling characteristics on paved roads

- Set correct spring preload and correct spring strut damping before leaving off-road terrain.◀

## Rims

BMW Motorrad recommends checking the rims for possible damage after riding offroad.

## Air cleaner insert



### ATTENTION

## Dirty air filter element

Engine damage

- When driving in dusty terrain, check air filter insert for soiling at short intervals and clean or replace if necessary. ◀

Use under very dusty conditions (deserts, savannas, etc.) requires the use air cleaner inserts specially developed for these kinds of applications.

## Shifting gears

– with Gearshift Assistant Pro<sup>OE</sup>

## Shift assistant Pro Requirement

The Gearshift Assistant provides assistance for upshifts and downshifts, without the rider having to actuate the clutch or throttle grip. This is not an automatic-shift system. The rider is the most important part of the system and decides when to shift gears.



### NOTICE

More detailed information on Pro Gear-shift Assistance can be found in the section "Technology in detail". ◀



### NOTICE

When downshifting using the Pro Gearshift Assistant, the cruise control system is automatically deactivated for safety reasons. ◀

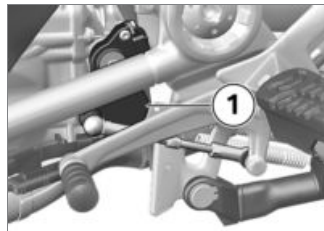

- The gears are shifted into as usual with foot force on the shift lever.
- » The sensor **1** on the gearshift shaft detects the gearshift request and triggers the shift assistance.
- » When riding at a steady speed in a low gear at high engine rpm, an attempt to shift gear without pulling the clutch can cause a severe load-change reaction. BMW Motorrad recommends disengaging the clutch for shifts in these circumstances. Use of the Pro Gear Shift Assistant should



be avoided at engine speeds where the engine speed limiter becomes active.

- » Shift assistance is not available in the following situations:
  - With clutch actuated.
  - Shift lever not in its initial position.
  - When upshifting with closed throttle valve (coasting overrun) or when decelerating.
  - When downshifting with open throttle valve or when accelerating.
- To be able to make another gear shift using the Pro Gear Shift Assistant, the gearshift lever must be fully released after the first gear change.

## Brakes

### How do you achieve the shortest stopping distances?

The dynamic load distribution between the front and rear wheel changes during braking. The heavier you brake, the greater the weight transfer to the front wheel. Increases in the load at an individual wheel are accompanied by a rise in the effective braking force that the wheel can provide.

To achieve the shortest possible braking distance, the front brake must be applied quickly and with increasing force. This procedure provides ideal exploitation of the extra weight transfer to the front wheel. The clutch should also be disengaged at the same time. With the "forced braking" often practiced in which the brake pressure is generated as quickly

as possible and with great force, the dynamic load distribution cannot follow the increased deceleration and the braking force cannot be completely transferred to the road surface.

Locking up of the front wheel is prevented by the BMW Motorrad Integral ABS.

### Descending mountain passes



#### **Braking only with the rear-wheel brake when descending mountain passes**

Reduced of braking action, destruction of the brakes caused by overheating

- Use both front and rear brakes, and make use of the engine's braking effect as well. ◀

## Wet, soiled brakes

Moisture and dirt on the brake rotors and the brake pads result in a decrease in the braking action.

Delayed or poorer braking action must be expected in the following situations:

- When driving in the rain and through puddles.
- After washing the vehicle.
- When driving on roads spread with salt.
- After working on the brakes due to oil or grease residues.
- When driving on soiled roads or offroad.



### WARNING

#### Poorer braking action due to moisture and dirt

Accident hazard

- Brake until brakes are dry or clean; clean if necessary.

- Brake early until the full braking action is available again.◀

## ABS Pro

- with ABS Pro<sup>OE</sup>

## Physical riding limits



### WARNING

#### Braking in curves

Danger of falling despite ABS Pro

- The rider is always responsible for adapting his/her driving style.
- Do not reduce the system's extra safety margin with careless riding or unnecessary risks.◀

ABS Pro and the supporting function of the Dynamic Brake Control are available in all riding modes except Enduro PRO.

## Falling cannot be excluded

Although ABS Pro and Dynamic Brake Control represent valuable support and an enormous safety advantage for the rider when braking in an inclined position, they by no means redefine the physical riding limits. It is still possible to exceed those limits through misjudgments or riding errors. In extreme cases this may result in a fall.

## Use on public roads

ABS Pro and Dynamic Brake Control help make riding your motorcycle on public roads even safer. When braking due to unexpected hazards in curves, locking-up and slipping of the wheels is prevented within the scope of the physical riding limits. In the event of emergency braking, Dynamic Brake Control enhances

the braking effect and intervenes if the throttle grip is accidentally actuated during braking.

## NOTICE

ABS Pro was not developed to increase the individual braking performance in the inclined position. ◀

## Parking your motorcycle

### Side stand

- Switch off engine.

## ATTENTION

### Poor ground conditions in area of stand

Component damage cause by tipping over

- Always check that the ground under the stand is level and firm. ◀

## ATTENTION

### Loading of the side stand with additional weight

Component damage cause by tipping over

- Do not sit on the motorcycle when it is parked on the side stands. ◀
- Fold out side stand and park motorcycle.
- Turn handlebars to the left.
- On slopes point the motorcycle uphill and engage 1st gear.

### Center stand

- Switch off engine.

## ATTENTION

### Poor ground conditions in area of stand

Component damage cause by tipping over

- Always check that the ground under the stand is level and firm. ◀

## ATTENTION

### Center stand folds if subject to sharp movements.

Component damage cause by tipping over

- Do not sit on the motorcycle while it is resting on the center stand. ◀
- Fold out center stand and jack up motorcycle.
- On a grade, the motorcycle should always face uphill; select 1st gear.

## Refueling

### Fuel specifications Requirement

For optimal fuel economy, the gasoline should be sulfur-free or very low in sulfur content.

**ATTENTION****Refueling with leaded fuel**

Damage to catalytic converter

- Do not refuel with leaded gasoline or gasoline with metallic additives, e.g. manganese or iron. ◀

**ATTENTION****Use of Ethanol E85 as fuel**

Damage to the engine and fuel supply

- Do not refuel with E85, i.e. fuel with an ethanol content of 85 %, or with Flex Fuel. ◀
- Observe the maximum ethanol content of the fuel.



Recommended fuel quality

Super unleaded (max. 15 % ethanol, E15)  
89 AKI (95 ROZ/RON)  
90 AKI



Alternative fuel quality

Normal unleaded (with performance penalty) (max. 15 % ethanol, E15)  
87 AKI (91 ROZ/RON)  
87 AKI

» After refueling with lower quality fuels, there may occasionally be a knocking noise.

**Refueling procedure****WARNING****Fuel is highly flammable**

Fire and explosion hazard

- Do not smoke. Never bring a naked flame near the fuel tank. ◀

**WARNING****Escaping of fuel due to expansion under exposure to heat with overfilled fuel tank**

Accident hazard

- Do not overfill the fuel tank. ◀

**ATTENTION****Contact of fuel and plastic surfaces**

Damage to surfaces (become unattractive or cloudy)

- Immediately clean plastic surfaces after contact with fuel. ◀
- Place motorcycle on center stand, ensuring that it is resting on a firm and level support surface.

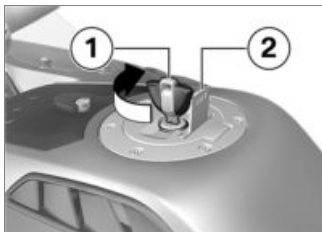

- Open the protective cap **2**.
- Unlock the fuel tank cap in a clockwise direction using the ignition key **1** and fold it up.



- Refuel up to the lower edge of the filler neck, but no higher.

### NOTICE

If refueling is carried out after running on fuel reserve, the resulting filling capacity must be greater than the fuel reserve so that the new fill level is detected and the fuel reserve indicator light is switched off.◀

### NOTICE

The "usable fuel quantity" specified in the technical data is the fuel quantity, which can be refueled if the fuel tank was completely emptied, i.e., if the engine dies off due to lack of fuel.◀

 Usable fuel quantity

Approx. 7.9 gal (Approx. 30 l)

 Reserve fuel quantity

Approx. 1.1 gal (Approx. 4 l)

- Press fuel tank cap down firmly to close.
- Remove key and close protective cap.

### Refueling procedure

– with Keyless Ride<sup>OE</sup>

### Requirement

Steering lock is unlocked.

### WARNING

### Fuel is highly flammable

Fire and explosion hazard

- Do not smoke. Never bring a naked flame near the fuel tank.◀



long as the radio-operated key is being searched for.

- Slowly pull lug **1** of fuel filler cap upward again.
- » Fuel filler cap unlocked.
- Open fuel filler cap completely.



- Refuel with a fuel meeting the specifications above, continuing until fuel is no higher than lower edge of filler neck.

#### NOTICE

If refueling is carried out after running on fuel reserve, the resulting filling capacity must be greater than the fuel reserve so

that the new fill level is detected and the fuel reserve indicator light is switched off.◀

#### NOTICE

The "usable fuel quantity" specified in the technical data is the fuel quantity, which can be refueled if the fuel tank was completely emptied, i.e., if the engine dies off due to lack of fuel.◀



Usable fuel quantity

Approx. 7.9 gal (Approx. 30 l)



Reserve fuel quantity

Approx. 1.1 gal (Approx. 4 l)

- Press fuel filler cap of fuel tank down firmly.
- » Fuel filler cap audibly engages.
- » Fuel filler cap automatically locks after run-on time expires.

- » The engaged fuel filler cap locks immediately when the steering lock is locked or during starting.

## Securing motorcycle for transportation

- Protect all component surfaces against which straps are routed against scratching. For example, use adhesive tape or soft cloths.

 **ATTENTION****Motorcycle tips to the side when raising**

Component damage cause by tipping over

- Secure the motorcycle against tipping to the side, preferably with the assistance of a second person.◀
- Push the motorcycle onto the transportation flat and hold it in position: do not place it on the side stand or center stand.

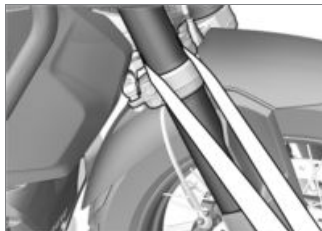
 **ATTENTION****Pinching of components**

Component damage

- Do not pinch components, e.g. brake lines or wiring harnesses.◀
- Pass the straps on the left and right through the fork bridge and strap the motorcycle down.



- Fasten the rear tensioning straps on both sides of the holder for the passenger footrests and tighten.
- Tension all straps evenly so that the vehicle is securely fastened.



## Technology in detail

General notes.....	144
Antilock Braking System (ABS) ....	144
Traction control (ASC/DTC).....	147
Dynamic ESA.....	149
Riding mode .....	150
Dynamic Brake Control .....	152
Tire pressure control (TPC/ RDC) .....	153
Shift assistant.....	155
Hill Start Control .....	156
ShiftCam .....	157

## General notes

More information on the topic of technology is available at:

**[bmw-motorrad.com/technology](http://bmw-motorrad.com/technology)**

## Antilock Braking System (ABS)

### Partially integral brake

Your motorcycle is equipped with a partially integral brake configuration. Both front and rear brakes are applied simultaneously when you pull the handbrake lever.

The footbrake lever acts only on the rear brake.

The BMW Motorrad Integral ABS adapts the braking force distribution between the front and rear wheel brake to the loading of the motorcycle during braking with ABS control.



## ATTENTION

### Attempt at a burn-out despite integral function

Damage to rear-wheel brake and clutch

- Do not perform burn-out. ◀

### How does ABS work?

The maximum braking force that can be transferred to the road surface is partially dependent on the friction coefficient of the road surface. Gravel, ice, snow and wet roads offer a considerably lower friction coefficient than a dry, clean asphalt surface. The poorer the friction coefficient of the road surface is, the longer the braking distance will be.

If the maximum transferable braking force is exceeded when the rider increases the brake pressure, the wheels begin to lock and driving stability is lost, and a fall can result. Before this sit-

uation occurs, ABS is activated and the brake pressure is adjusted to the maximum transferable braking force. This enables the wheels to continue to turn and maintains driving stability regardless of the road surface condition.

### What happens when rough roads are encountered?

Bumpy or rough roads can briefly lead to a loss of contact between the tires and the road surface, until the transferable braking force is reduced to zero. If the brakes are applied in this situation, the ABS must reduce the brake pressure to ensure driving stability when contact to the road is restored. At this point, the BMW Motorrad Integral ABS must assume extremely low friction coefficients (gravel, ice, snow) so that the road wheels

turn in every imaginable case and the driving stability is ensured. After detecting the actual conditions, the system adjusts the optimum brake pressure.

## How is the BMW Motorrad Integral ABS noticeable to the rider?

If the ABS system must reduce the braking forces due to the conditions described above, then vibrations can be felt at the handbrake lever.

If the handbrake lever is pulled, then braking pressure is built up at the rear wheel with the integral function. If the footbrake lever is first actuated after this, the brake pressure already built up can be felt earlier than the counter-pressure, than when the footbrake lever is actuated before or together with the handbrake lever.

## Lifting off rear wheel

However, during extremely heavy and rapid deceleration it is possible that the BMW Motorrad Integral ABS will not prevent the rear wheel from lifting off the ground. In these cases, the motorcycle can also flip end over end.



### Lifting off of the rear wheel due to heavy braking

Accident hazard

- When braking heavily, bear in mind that the ABS control cannot always be relied on to prevent the rear wheel from lifting off the ground. ◀

## What are the design characteristics of the BMW Motorrad Integral ABS?

The BMW Motorrad Integral ABS ensures driving stability on any surface within the limits of driving physics. The system is not optimized for special requirements resulting under extreme weather conditions offroad or on the racetrack. Handling should be adopted to driving skills and road conditions.

### Special situations

To detect the tendency of the wheels to lock up, the speeds of the front and rear wheel are compared. If implausible values are detected over a longer period of time, the ABS function is deactivated for safety reasons and an ABS error is indicated. A self-diagnosis routine must be com-

pleted before the error will be displayed.

Apart from problems with the BMW Motorrad ABS, unusual riding conditions can also cause a fault message to be generated:

- Warm-up on the center or auxiliary stand at idle or with gear engaged.
- Rear wheel locked-up for a longer period of time by engine brake, e.g. when riding downhill on slippery surfaces.

Should a fault code occur due to an unusual driving condition, the ABS function can be reactivated by switching the ignition off and then on again.

## How important is regular maintenance?



### WARNING

#### Failure to have maintenance performed on the brake system regularly.

Accident hazard

- To ensure that the ABS is in a properly maintained condition, it is vital that the specified service intervals be observed.◀

#### Reserves for safety

But remember: the potentially shorter braking distances which BMW Motorrad Integral ABS permits must not be used as an excuse for careless riding. ABS is primarily a means of ensuring a safety margin in genuine emergencies.



### WARNING

#### Braking in curves

Risk of accident despite ABS

- The rider is always responsible for adapting his/her driving style.
- Do not reduce the additional safety function with careless riding or unnecessary risks.◀

#### Further development of ABS to ABS Pro

– with ABS Pro<sup>OE</sup>

In the past, the BMW Motorrad ABS system provided for a very high level of safety while braking during straight-ahead riding. Now ABS Pro also offers increased safety even when braking in curves. ABS Pro prevents locking-up of the wheels even in case of rapid brake actuation. ABS Pro reduces abrupt changes in steering forces, especially during panic braking, and therefore decreases the risk of unwanted wheelies occurring.

## ABS control

From a technical standpoint, ABS Pro adjusts the ABS control to the angle of inclination of the motorcycle in dependence on the respective riding situation. Signals for the roll and yaw rate and the lateral acceleration are used to determine the inclination of the motorcycle.

With an increasing inclination, the braking pressure gradient is increasingly limited at the start of braking. This results in a slower pressure buildup. In addition, the pressure modulation in the range of the ABS control is more uniform.

## Advantages for the rider

The advantages of ABS Pro for the rider are sensitive response and high braking and riding stability with the best possible deceleration, even in curves.

## Traction control (ASC/DTC)

### How does traction control work?

Traction Control is available in two versions

- **Without** taking the angle into account: Automatic Stability Control ASC
- ASC is a rudimentary function intended to prevent falls.
- **With** taking the angle into account: Dynamic Traction Control DTC
- The additional inclined position and acceleration information enables the DTC to make more precise and comfortable adjustments.

The traction control compares the speeds at the perimeters of the front and rear wheel. The slip, and with it the stability reserves at the rear wheel, are de-

termined from the speed difference. The engine management system adapts the engine torque when the slip limit is exceeded. BMW Motorrad ASC/DTC is designed as an assistance system for the rider and for riding on public roads. The extent to which the rider affects ASC/DTC control can be considerable (weight shifts when cornering, loose luggage on the motorcycle), especially when approaching the limits imposed by the laws of physics.

The **Enduro** riding mode should be activated for off-road riding. In this mode, the controlling intervention by the ASC/DTC is carried out later, enabling controlled drifting.

The system is not optimized for the special conditions encountered under extreme weather during off-road and race-track use. BMW Motorrad ASC/DTC

can be switched off under these conditions.



## WARNING

### Risky riding style

Accident hazard despite ASC/DTC

- The rider is always responsible for adapting his/her driving style.
- Do not reduce the system's extra safety margin with careless riding or unnecessary risks. ◀

### Special situations

As lean angles increase, acceleration potential is also progressively restricted by the laws of physics. This can result in reduced acceleration when coming out of very tight curves.

To detect spinning or slipping away of the rear wheel, among other things the speeds of the front and rear wheel are compared and the angle with DTC compared to ASC is taken into account.

– with riding modes Pro<sup>OE</sup>

If the value for the angle are detected to be implausible for a long period, a replacement value is used for the angle or the DTC function is deactivated. In these cases, a DTC error is displayed. A self-diagnosis routine must be completed before the error will be displayed.

Under the following unusual riding conditions, BMW Motorrad Traction Control may be deactivated automatically.

#### Unusual riding conditions:

- Driving on the rear wheel (wheelie) for a longer period.

- Rear wheel spinning in place with front brake engaged (burn out).
- Heating up on an auxiliary stand at idle speed or with gear engaged.

If the coding plug is not in use, turning the ignition off and on again and then riding the motorcycle at a minimum speed reactivates the DTC after a fault.



Minimum speed for DTC activation

min 3 mph (min 5 km/h)

If the front wheel loses contact with the ground under extreme acceleration, the ASC or DTC function reduces the engine torque in the RAIN and ROAD riding modes until the front wheel makes contact with the ground again.

The riding modes **ENDURO** and **ENDURO PRO** are designed for off-road riding and are not suitable for road operation.

In the DTC settings **DYNAMIC**, **DYNAMIC PRO**, and **ENDURO**, the front wheel lift-off detection permits brief wheelies.

In the DTC setting **ENDURO PRO**, the front wheel lift-off detection is turned off.

In the **RAIN**, **ROAD**, **DYNAMIC**, and **ENDURO** riding modes, the DTC setting corresponds to the riding mode.

In the **ENDURO PRO** and **DYNAMIC PRO** riding modes, the DTC can be set differently (▣➔ 76).

BMW Motorrad recommends that you respond to the front wheel lifting off by twisting back the throttle grip somewhat to return to a stable driving condition as quickly as possible.

On a slippery surface, the throttle grip should never be suddenly twisted back completely unless the clutch is disengaged at the same time. The engine braking torque can cause the rear wheel to slip, resulting in an unstable driving state. This case cannot be controlled by BMW Motorrad DTC.

## **Dynamic ESA**

– with Dynamic ESA<sup>OE</sup>

## **Riding position compensation**

The Dynamic ESA electronic chassis and suspension adjustment can automatically adapt your motorcycle to the load. If the spring preload is set to **AUTO**, the driver does not have to worry about adjusting the load.

When the motorcycle is started and while it is being driven, the system monitors the compres-

sion of the rear wheel and corrects the spring preload to ensure that the correct driving position is set. The damping is also automatically adjusted to the load.

Using ride height sensors, Dynamic ESA detects the movements of the chassis and suspension and responds to them by adjusting the EDC valves. As a result, the chassis and suspension is adjusted to the conditions of the surface.

Dynamic ESA calibrates itself at regular intervals to ensure that the system is operating correctly.

## **Adjustment options**

### **Damping modes**

- Road: Damping for comfortable road travel
- Dynamic: Damping for dynamic road travel

- Enduro: Damping for off-road riding

### Load settings

- Auto: Active riding position compensation with automatic adjustment of spring preload and damping
- Min: Minimum spring preload
- Max: Maximum spring preload (for off-road use)
- The Min and Max spring preloads may be selected by the driver, but they cannot be changed. The riding position compensation function is deactivated in the Min and Max settings.

## Riding mode

### Selection

In order to adjust the motorcycle to the road condition and the desired riding experience, it is

possible to select one of the following riding modes:

- RAIN
- ROAD (standard mode)
- with riding modes Pro<sup>OE</sup>
- DYNAMIC
- ENDURO

With an integrated coding plug, the riding modes DYNAMIC PRO and ENDURO PRO replace the riding modes DYNAMIC and ENDURO.

For each of these riding modes, there is a coordinated setting for the ABS, ASC, and DTC systems as well as for the throttle response.

- with Dynamic ESA<sup>OE</sup>

The coordination of the Dynamic ESA also depends on the selected riding mode.

ABS and/or ASC/DTC can be switched off in each riding mode. The following explanations always refer to the riding safety systems that are switched on.

### Throttle response

- In the RAIN and ENDURO riding modes: restrained
- In the ROAD and ENDURO PRO riding modes: direct
- In the DYNAMIC and DYNAMIC PRO riding modes: dynamic
- In the DYNAMIC PRO and ENDURO PRO riding modes, the throttle response can be set differently via the SETUP (▣▶ 74).

### ABS

- Rear wheel lift-off detection is active in all riding modes.
- In the RAIN, ROAD, DYNAMIC, and DYNAMIC PRO riding



- modes, the ABS is set for road use.
- In the ENDURO riding mode, ABS is set for off-road use with road tires.
- with riding modes Pro<sup>OE</sup>
- In riding mode ENDURO PRO, there is no ABS control on the rear wheel when the footbrake lever is actuated. The ABS is adjusted to off-road use with lugged tires.
- In the ENDURO PRO riding mode, the ABS can be set differently via the SETUP (▶▶▶ 74).
- In the RAIN, ROAD, DYNAMIC, and DYNAMIC PRO riding modes, the ABS Pro is available to its full capacity. The inclination the motorcycle has when braking in curves is reduced to a minimum.

- In the riding mode ENDURO, the support of ABS Pro is reduced compared to ROAD.
- In riding mode ENDURO PRO, ABS Pro is not available.

### ASC

- Front wheel lift-off detection is active in all riding modes.
- ASC is set for road use.
- In the ROAD riding mode, ASC provides high riding stability, and maximum riding stability in the RAIN riding mode.

- with riding modes Pro<sup>OE</sup>

### DTC

#### Tires

- In the DTC settings RAIN, ROAD, and DYNAMIC, the DTC is set for road use with road tires.
- In the DTC setting ENDURO, the DTC is set for off-road use with road tires.

- In the DTC setting ENDURO PRO, the DTC is set for off-road use with lugged tires.

### Riding stability

- In the DTC setting RAIN, the DTC intervenes early enough to ensure that maximum riding stability is achieved.
- In the DTC setting ROAD, the DTC intervenes later than in RAIN riding mode. A rear wheel spin is avoided wherever possible.
- In the DTC settings RAIN and ROAD, the front wheel is prevented from lifting off.
- In the DTC setting DYNAMIC, the DTC intervenes later than in the DTC setting ROAD, which enables minor drifts at the end of curves and brief wheelies.
- In the DTC setting ENDURO, the DTC intervenes even later and is set to off-road use so

- that longer drifts and brief wheelies are possible at the end of curves.
- In the DTC setting ENDURO PRO, the DTC control assumes that lugged tires are being driven off-road. The front wheel lift-off detection is turned off, which enables wheelies of any duration and height. In extreme cases, the vehicle can roll over backward!

In the RAIN, ROAD, DYNAMIC, and ENDURO riding modes, the DTC setting corresponds to the riding mode.

In the ENDURO PRO and DYNAMIC PRO riding modes, the DTC can be set differently (▶▶▶ 76).

## Changing setting

Riding modes can be changed when the vehicle is at a standstill with the ignition switched on. A changeover while riding is possible under the following conditions:

- No drive torque at rear wheel.
- No brake pressure in the braking system.

For a changeover while riding, the following steps must be carried out:

- Turn back throttle grip.
- Do not actuate brake lever.
- Deactivate the cruise control.

First the desired riding mode is preselected. The new selection is not activated until the specified conditions are present in all affected systems.

The selection menu does not disappear in the display until the

riding mode has been switched over.

## Dynamic Brake Control

- with riding modes Pro<sup>OE</sup>

### Dynamic Brake Control function



#### NOTICE

The Dynamic Brake Control function is active in all riding modes. It can only be deactivated in the RACE PRO riding modes by individually adjusting the ABS. ◀

The Dynamic Brake Control function helps the rider in the event of emergency braking.

### Detection of emergency braking

- Emergency braking is detected when the front wheel brake is applied quickly and with force.

## Behavior during emergency braking

- If emergency braking is applied at a speed of more than 10 km/h, in addition to the ABS function the Dynamic Brake Control function will also be activated.
- In the event of partial braking with high brake pressure gradients, Dynamic Brake Control will increase the integral brake pressure on the rear wheel. This shortens the braking distance, enabling controlled braking.

## Behavior in the event of accidental activation of the throttle grip

- If the throttle grip is accidentally activated during emergency braking (throttle position >5%), the intended braking effect is ensured by the Dynamic Brake Control by

shutting off the gas. This ensures activation of emergency braking.

- If the gas is shut off (throttle position <5%) during the intervention of the Dynamic Brake Control, the engine torque required by the ABS brake system will be restored.
- If the emergency braking is stopped and the throttle grip is still activated, the Dynamic Brake Control reduces the engine torque as required by the rider in a controlled manner.



### NOTICE

When the ABS is switched off, the Dynamic Brake Control function is switched off at the same time. ◀

## Tire pressure control (TPC/RDC)

- with tire pressure monitor (TPM)<sup>OE</sup>

### Operation

A sensor located in each tire monitors the air temperature and the inflation pressure inside the tire and transmits this information to the control unit.

The sensors are equipped with a centrifugal controller, which does not enable the transmission of the measured values until the minimum speed is exceeded for the first time.



Minimum speed for the transmission of the TPC/RDC measured values:

min 19 mph (min 30 km/h)

Before initial reception of the tire pressure, -- is shown in the display for each tire. The sensors

continue to transmit the measured readings for some time after the vehicle comes to a stop.



Transmission time of the measured values after vehicle standstill:

min 15 min

If an TPC/RDC control unit is installed but the wheels have no sensors, a fault message is generated.

## Tire inflation pressure ranges

The TPC/RDC control unit distinguishes between three inflation pressure ranges matched to the motorcycle:

- Tire pressure within the permissible tolerance
- Tire pressure within the limit range of the permissible tolerance
- Tire pressure outside of the permissible tolerance

## Temperature compensation

The tire inflation pressure is temperature dependent, i.e. it increases or decreases together with the tire air temperature. The tire temperature is dependent on the outside temperature, the riding style and the length of the journey.



The tire pressures are shown in the TFT display with temperature compensation and are always based on the following tire air temperature:

68 °F (20 °C)

Tire pressure gages at gas stations do not make any adjustment for the air temperature, the tire pressure indicated depends on the temperature of the air in the tire. As a result, in most cases the values displayed there

do not match the values shown in the TFT display.

## Tire pressure adjustment

Compare the TPC/RDC value in the TFT display with the value on the back cover of the operating instructions. The difference between the two values must be compensated with the tire inflation pressure tester at the filling station.



Example

According to the rider's manual, the tire pressure should have the following value:

36.3 psi (2.5 bar)

The following value is displayed in the TFT display:

33.4 psi (2.3 bar)

Missing is thus:



Example

2.9 psi (0.2 bar)

The tester at the filling station shows:

34.8 psi (2.4 bar)

To produce the correct tire pressure, this must be increased to the following value:

37.7 psi (2.6 bar)

## Shift assistant

– with riding modes Pro<sup>OE</sup>

### Shift assistant Pro

Your motorcycle is equipped with a Pro gearshift assistant originally developed for racing but now specially adapted for touring use. It allows you upshift and downshift under almost any load conditions and in virtually all engine-

speed ranges without operating the clutch or accelerator.

### Benefits

- 70-80 % of all gear changes can be performed without using the clutch.
- Less movement between pilot and pillion due to shorter gear-change intervals.
- Throttle does not have to be closed when changing gear under acceleration.
- During deceleration and downshifts (throttle plate closed) the system blips the throttle to obtain the correct engine speed.
- Shifting times are faster than when the clutch is used to change gears.

For the system to detect the rider's intention to change gear, the gearshift lever previously not operated must be moved against the force of the spring by a cer-

tain amount of "overtravel" in the desired direction with a normal to brisk action and held in that position until the gear change is completed. A further increase of the force applied to the gearshift lever during the gear-shift operation is not necessary. After the gear change is completed, the gear lever must be fully released before the Pro gearshift assistant can execute a new gear change. The load factor (throttle grip position) should remain constant both prior to and during execution of shifts using the Pro gearshift assistant. Changing the accelerator twist-grip position during the gear-shift operation may cause the function to abort and/or the gear change to fail. The Pro gearshift assistant does not provide support when gear changes are made using the clutch.

## Downshifts

- Downshifts are assisted up to the speed at which the engine reaches maximum rpm in the gear to be engaged. Over-revving is thus prevented.



Maximum engine speed

max 9000 min<sup>-1</sup>

## Upshifts

- Upshifting is only possible if the current RPM is higher than the release threshold for the next higher gear.
- This prevents the idling speed from being dropped below.



Idle speed

1050 min<sup>-1</sup> (Engine at operating temperature)



Release thresholds

1st gear

min 1350 min<sup>-1</sup>

2nd gear

min 1400 min<sup>-1</sup>

3rd gear

min 1450 min<sup>-1</sup>

4th gear

min 1500 min<sup>-1</sup>

5th gear

min 1550 min<sup>-1</sup>

6th gear

min 1600 min<sup>-1</sup>

## Hill Start Control

### Hill Start Control function

The Hill Start Control prevents an uncontrolled rolling back on slopes by means of targeted intervention in the partial integral

ABS brake system, without the rider having to continuously operate the brake lever. When Hill Start Control is activated, pressure builds in the rear brake system so that the motorcycle remains stationary on a sloping surface.

The brake pressure in the brake system depends on the gradient.

### Influence of gradient on brake pressure and starting behavior

- Stopping on a slight incline builds up only a small amount of brake pressure. The brake is released quickly when driving off, making it possible to drive off more smoothly. Additional turning of the throttle grip is hardly necessary.
- Stopping on a steeper slope increases the amount of brake pressure built up. The brake is a bit slower to release when driving off. More torque is re-

quired to drive off, making additional turning of the throttle grip necessary.

### **Behavior when the vehicle is rolling or slipping**

- The brake pressure increases when the vehicle is rolling with Hill Start Control active.
- If the rear wheel slips, the brake is released again after approx. 1 m. This prevents the vehicle from rolling with the rear wheel blocked.

### **Releasing the brake when switching off the engine or during timeout**

Hill Start Control is deactivated when the engine is switched off using the emergency-off switch, when the side stand is folded out, or after it times out (10 minutes).

In addition to the indicator and warning lights, the rider is to be

made aware about the deactivation of the Hill Start Control by the following behavior:

#### **Brake warning jerk**

- The brake is released briefly and is immediately reactivated.
- This causes a jerking behavior that the driver can feel.
- The partial integral ABS brake system sets a speed of approx. 1-2 km/h.
- The driver must brake the vehicle manually.
- After two minutes, or when the brake is applied, Hill Start Control is deactivated completely.

#### **NOTICE**

When the ignition is switched off, the holding pressure is built up immediately and without brake warning jerk. ◀

## **ShiftCam**

### **Principle of ShiftCam function**

The motorcycle is equipped with the BMW ShiftCam technology - a technique for varying the valve timing and the valve stroke on the inlet side. The centerpiece of this technology is a one-piece inlet trip camshaft that has two cams per valve to be actuated: one for partial load and one for full load. The partial load cam has been developed with regard to fuel economy optimization and smooth running. The partial load cam reduces both the control times adapted for this purpose and the inlet valve stroke. Furthermore, the inlet cams for the left and right inlet valve differ in stroke and angle position when the partial load cam is activated. This causes a staggered opening of the two in-

let valves, which have different widths. The advantage is that the fuel-air mixture flowing into the combustion chamber is more strongly swirled and more effectively burned. Overall, this results in optimal fuel efficiency and noticeably improves the smoothness of running. The full load cam is optimized for performance and releases the maximum inlet valve stroke. In order to vary the valve timing and the valve stroke, the inlet camshaft is shifted axially. For this purpose, the pins of an electromechanical actuator mesh with a shift gate on the inlet camshaft. This allows for the actuation of the inlet valves depending on load and motor speed and, as a result, an uncompromising symbiosis of performance and low fuel consumption.



## Maintenance

General notes.....	160
Onboard tool set.....	160
Service tool set .....	161
Front wheel stand .....	161
Engine oil .....	162
Brake system .....	164
Clutch .....	168
Coolant .....	168
Tires.....	169
Wheel rims and tires .....	170
Wheels .....	171
Air filter .....	177
Light sources .....	179
Jump-starting.....	180
Battery.....	182

Fuses .....	186
Data link connector .....	187

## General notes

The Maintenance chapter describes work involving the checking and replacement of wear parts that can be performed with a minimum of effort.

If special tightening torques are to be taken into account for assembly, these are listed. An overview of all required tightening torques is contained in the Technical Data chapter.

Information on additional maintenance and repair work is provided in the Repair Manual for your motorcycle on DVD, which you can obtain from your authorized BMW Motorrad retailer.

Special tools and thorough specialized knowledge are required to carry out some of the work described here. If you are in doubt, consult an authorized workshop, preferably your authorized BMW Motorrad retailer.

## Onboard tool set

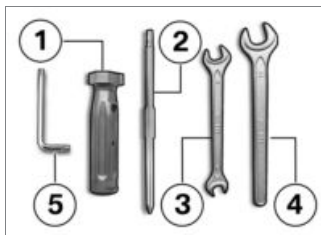

- 1** Screwdriver handle
  - Use with screwdriver insert
  - Topping up the engine oil (➡ 163).
- 2** Reversible screwdriver insert
  - Phillips PH1 and Torx T25
  - Remove light sources in front and rear turn indicators (➡ 179).
  - Remove battery cover (➡ 183).
  - Topping up coolant (➡ 169).
- 3** Open-ended wrench
  - Wrench size: 8/10 mm
  - Removing battery (➡ 183).
- 4** Open-ended wrench
  - Wrench size: 14
  - Adjust mirror arm (➡ 114).
- 5** Torx wrench T30
  - Adjusting the gearshift lever from below

## Service tool set

– with service tool set<sup>OA</sup>

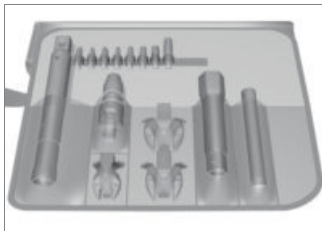

For expanded servicing (e.g. fitting and removing wheels), BMW Motorrad has set up a service toolkit designed for your motorcycle. You can obtain the toolkit from your BMW Motorrad retailer.

## Front wheel stand Mount front wheel stand

### ATTENTION

#### Use of the BMW Motorrad front wheel stand without an additional center or auxiliary stand

Component damage cause by tipping over

- Place the motorcycle on the center stand or an auxiliary stand before lifting it with the BMW Motorrad front wheel stand. ◀
- Place motorcycle on center stand, ensuring that it is resting on a firm and level support surface.
- Use basic stand with front wheel mount. The basic stand and its accessories are available through your authorized BMW Motorrad retailer.

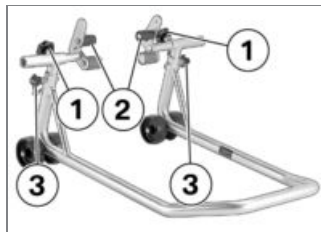

- Loosen screws **1**.
- Push the two mounts **2** outward, continuing until front suspension fits between them.
- Use locating pins **3** to set front wheel stand to desired height.
- Center front wheel stand relative to front wheel and push it against front axle.



- Align the two mounts **2** so that front suspension rests securely on them.
- Tighten screws **1**.

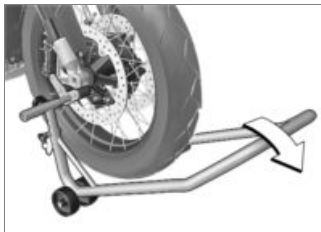

### ATTENTION

#### **Center stand retracts if motorcycle is lifted too high.**

Component damage cause by tipping over

- When raising the motorcycle, make sure that the center stand remains on the ground.◀
- Apply uniform pressure to push front wheel stand down and raise motorcycle.

## Engine oil

### Checking the engine oil level

#### NOTICE

It is possible to misinterpret the oil capacity as the oil level depends on the temperature.◀

- Check that the motorcycle is at operating temperature and place it on its center stand, making sure the ground is level and firm.
  - with Style HP<sup>OE</sup>
- Make sure ground is level and firm and hold motorcycle at operating temperature vertically.◀
- Run the engine at idle until the fan starts.
- Switch off engine at operating temperature.
- Wait five minutes to allow oil to drain to the oil pan.

## NOTICE

BMW Motorrad recommends occasionally checking the motor oil after a journey of at least 50 km in order to reduce the environmental impact.◀

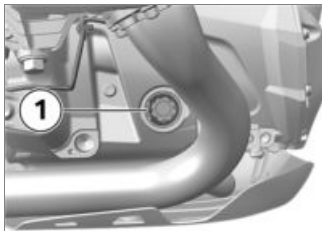

- Read oil level on the display **1**.

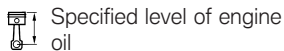
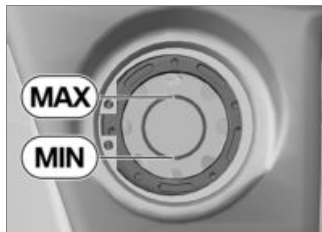

Between MIN and MAX mark

If oil level is below MIN mark:

- Topping up the engine oil (➔ 163).

If the oil level is above the MAX mark:

- Have oil level corrected at an authorized service facility, preferably an authorized BMW Motorrad retailer.

## Topping up the engine oil

- Park motorcycle on a level, firm surface.

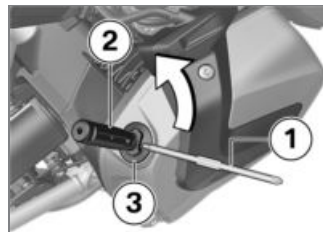

- Wipe the area around the oil filler opening clean.
- To be able to apply force more easily, insert the interchangeable screwdriver insert **1** Torx-end first, into the screwdriver handle **2** (from on-board tool kit).
- Position the specified tool from the on-board tool kit on the cap **3** of the oil filler opening and turn counter-clockwise to remove it.

- Checking the engine oil level (►► 162).



## ATTENTION

### Use of too little or too much engine oil

Engine damage

- Always make sure that the oil level is correct. ◀
- Top up the engine oil to the specified level.



Engine oil, quantity for topping up

max 0.8 quarts (max 0.8 l) (Difference between MIN and MAX)

- Checking the engine oil level (►► 162).
- Install the cap **3** of the oil filler opening.

## Brake system

### Checking brake operation

- Actuate the handbrake lever.
  - » Pressure point must be clearly perceptible.
- Actuate the footbrake lever.
  - » Pressure point must be clearly perceptible.

If no clear pressure points are perceptible:



## ATTENTION

### Improper working on the brake system

Endangering of the operating safety of the brake system

- Have all work on the brake system carried out by experts. ◀
- Have the brakes checked at an authorized workshop, preferably an authorized BMW Motorrad retailer.

## Checking the front brake pad thickness

- Park motorcycle on a level, firm surface.



- Visually inspect left and right brake pads to determine their thickness. Viewing direction: between wheel and front suspension toward brake pads **1**.

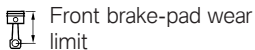

0.04 in (1.0 mm) (Only friction material without carrier plate. Wear markings (grooves) must be clearly visible.)

If the wear indicators are no longer clearly visible:

## **WARNING**

### **Dropping below the minimum pad thickness**

Reduced braking action, damage to the brake

- In order to ensure the operating reliability of the brake system, make sure that the brake pads are not worn beyond their minimum thickness. ◀
- Have brake pads replaced at an authorized service facility, preferably an authorized BMW Motorrad retailer.

### **Checking rear brake pad thickness**

- Park the motorcycle, ensuring that the support surface is firm and level.

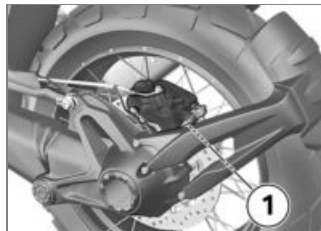

- Conduct a visual inspection of the brake pad thickness. Viewing direction: between splash guard and rear wheel toward brake pads **1**.



 Rear brake-pad wear limit

0.04 in (1.0 mm) (Only friction material without carrier plate.)

If wear limit is reached:

### **WARNING**

#### **Dropping below the minimum pad thickness**

Reduced braking action, damage to the brake

- In order to ensure the operating reliability of the brake system, make sure that the brake

pads are not worn beyond their minimum thickness. ◀

- Have the brake pads replaced by a specialist service facility, preferably an authorized BMW Motorrad retailer.

### **Check front brake fluid level**

#### **WARNING**

#### **Insufficient brake fluid in the brake-fluid reservoir**

Considerably reduced braking performance caused by air in the brake system

- Adjust the riding mode immediately until the fault is rectified.
- Check brake fluid level regularly. ◀
- Make sure ground is level and firm and place motorcycle on its center stand.

- Move handlebars into straight-ahead position.



- Check brake fluid level in front brake-fluid reservoir **1**.

#### **NOTICE**

The brake fluid level in the brake-fluid reservoir drops due to brake pad wear. ◀





 Front brake fluid level

Brake fluid, DOT4

The brake fluid level must not fall below the MIN mark. (Brake-fluid reservoir horizontal, motorcycle standing upright)

If brake fluid level falls below the approved level:

- Have the defect corrected as soon as possible by an authorized workshop, preferably an authorized BMW Motorrad retailer.

## Checking rear brake fluid level

 **WARNING**

### Insufficient brake fluid in the brake-fluid reservoir

Considerably reduced braking performance caused by air in the brake system

- Adjust the riding mode immediately until the fault is rectified.
- Check brake fluid level regularly. ◀
- Make sure ground is level and firm and place motorcycle on its center stand.



- Check level of brake fluid in rear brake-fluid reservoir **1**.

 **NOTICE**

The brake fluid level in the brake-fluid reservoir drops due to brake pad wear. ◀



Rear brake fluid level

Brake fluid, DOT4

The brake fluid level must not fall below the MIN mark. (Brake-fluid reservoir horizontal, motorcycle standing upright)

If brake fluid level falls below the approved level:

- Have the defect corrected as soon as possible by an authorized workshop, preferably an authorized BMW Motorrad retailer.

## Clutch

### Check clutch function

- Pull back the clutch lever.
  - » Pressure point must be clearly perceptible.

If no clear pressure point can be felt:

- Have the clutch checked by an authorized workshop, preferably an authorized BMW Motorrad retailer.

## Coolant

### Checking coolant level



**CAUTION**

### Working on hot cooling system

Burn hazard

- Only carry out work on the cooling system when it has cooled down. ◀

- Park motorcycle on a level, firm surface.



- Read the coolant level on the expansion tank **1**.

If coolant level drops below approved level:

- Add coolant.

## Topping up coolant



- Remove screw **1** and remove lid **2**.

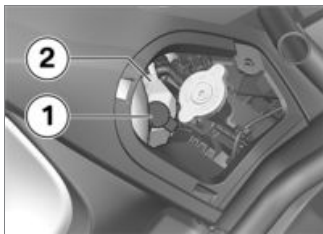

- Open the cap **1** of the coolant expansion tank **2** and top up coolant to the specified level.

- Checking coolant level (→ 168).
- Close the cap of the coolant expansion tank.



- Position the lid **1**.
- Install screw **2**.

## Tires

### Checking tyre pressure



### Incorrect tyre inflation pressure

Poorer handling characteristic of motorcycle, reduction of tire service life

- Ensure proper tire inflation pressure. ◀



### Automatic opening of vertically installed valve inserts at high speeds

Sudden loss of tire inflation pressure

- Use valve caps with rubber sealing ring and screw on firmly. ◀
- Park motorcycle, ensuring that support surface is firm and level.
- Check tyre pressures against data below.



Tire pressure, front

36.3 psi (2.5 bar) (with tire cold)



Tire pressure, rear

42.1 psi (2.9 bar) (with tire cold)

If tyre pressure is too low:

- Correct tyre pressure.

## Wheel rims and tires

### Check wheel rims

- Make sure ground is level and firm and park motorcycle.
- Subject wheel rims to visual inspection for defects.
- Have damaged rims checked and, if necessary, replaced by a specialist service facility, preferably an authorized BMW Motorrad retailer.

## Checking tire tread depth



### WARNING

### Riding with heavily worn tyres

Risk of accident due to poorer rideability

- If necessary, replace the tyres before the legally specified minimum tread depth is reached. ◀
- Make sure ground is level and firm and park motorcycle.
- Measure tire tread depth in main tread grooves with wear indicators.



### NOTICE

Tread wear marks are integrated into the main grooves on every tire. If the tire tread has worn down to the level of the marks, the tire is completely worn. The locations of the marks are indicated on the edge of the tire, e.g.

by the letters TI, TWI or by an arrow. ◀

When the minimum tread depth is reached:

- Replace the worn tires.

## Checking spokes

- Make sure ground is level and firm and park motorcycle.
- Sweep across spokes with a screwdriver handle or similar item, paying attention to the sound that they emit as you proceed.

If the tone does not remain consistent:

- Have spokes checked by an authorized service facility, preferably an authorized BMW Motorrad retailer.

## Wheels

### Affect of wheel sizes on suspension control systems

The wheel sizes play a major role for the ABS and ASC suspension control systems. The diameter and width of the wheels stored in the control unit have particular significance as the basis for all necessary calculations. A change in these sizes resulting from conversion to wheels not installed as standard equipment can seriously affect the control efficiency of these systems.

The sensor rings required for wheel speed detection must also match the installed control systems and may not be replaced. If you want to equip your motorcycle with different wheels, please contact a specialist service facility, preferably a BMW Motorrad retailer. In some

cases the data stored in the control units can be adapted for the new wheel sizes.

### TPC/RDC sticker

- with tire pressure monitor (TPM)<sup>OE</sup>

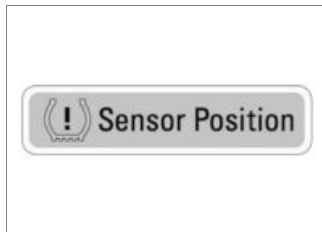

### ATTENTION

#### Improper tire removal

Damage to the TPC/TPC/RDC sensors

- Inform a specialist service facility or an authorized BMW Motorrad retailer on the

fact that the wheel is equipped with a TPC/TPC/RDC sensor. ◀

On motorcycles equipped with TPC/RDC, a corresponding sticker is located on the wheel rim at the position of the TPC/RDC sensor. During a tire change it must be ensured that the TPC/RDC sensor is not damaged. Inform the BMW Motorrad retailer or the authorized workshop of the TPC/RDC sensor.

### Removing front wheel

- Make sure the ground is level and firm and place the motorcycle on its center stand.



- Detach wheel speed sensor cable from the holding clips **1** and **2**.
- Remove screw **3** and remove wheel speed sensor from the bore.
- Mask off areas of wheel rim that could be scratched in the process of removing the brake calipers.



### ATTENTION

#### Unintentional pressing together of brake pads

Component damage when mounting the brake caliper or

when pressing the brake pads apart

- Do not actuate the brakes with the brake caliper removed. ◀
- Remove mounting bolts **4** of the left and right brake calipers.

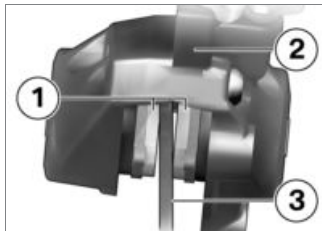

- Push brake pads **1** apart slightly by turning the brake caliper **2** back and forth against brake disc **3**.
- Carefully pull brake calipers back and outward to remove them from brake rotors.

- Raise front of motorcycle, preferably using a BMW Motorrad front wheel stand, continuing until the wheel rotates freely.
- Mount front wheel stand (▶▶ 161).



- Release the right axle clamping screw **1**.

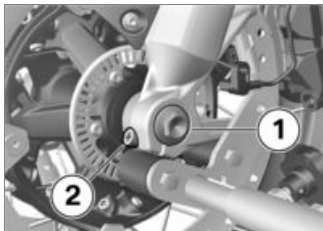

- Remove screw **1**.
- Release the left axle clamping screw **2**.
- Slightly press the quick-release axle inward for a better grip on the right side.

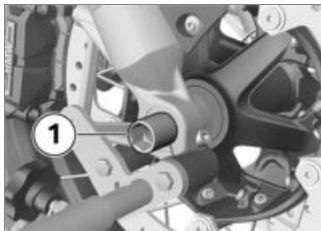

- Pull out the quick-release axle **1** while supporting the front wheel.
- Place front wheel down and roll it forward out of the front suspension.

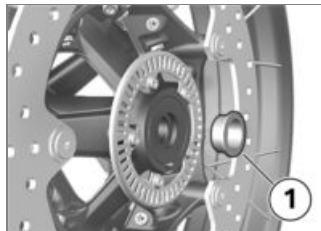

- Remove the spacer bushing **1** from the wheel hub.

## Installing the front wheel

### **WARNING**

#### **Use of a wheel which does not comply with series specifications**

Malfunctions during control interventions by ABS and ASC/DTC

- Please see the information on the effect of wheel sizes on the ABS and ASC/DTC chassis control systems at the beginning of this chapter. ◀

## ATTENTION

### Tightening of screwed connections with incorrect tightening torque

Damage or loosening of screwed connections

- Always have the tightening torques checked by a specialized workshop, preferably an authorized BMW Motorrad retailer. ◀

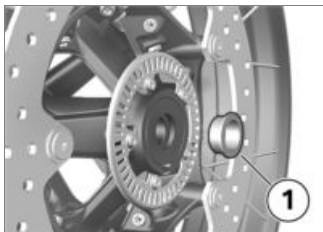

- Insert the spacing bushing **1** on the left side in wheel hub.

## ATTENTION

### Front wheel installation opposite the running direction

Accident hazard

- Observe running direction arrows on tire or rim. ◀
- Roll front wheel into front suspension.

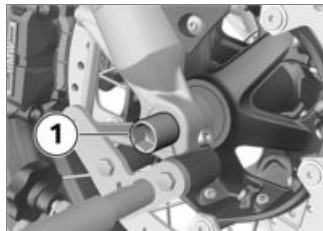

- Lift front wheel and install quick-release axle **1**.
- Remove front wheel stand and firmly compress front forks. Do not actuate handbrake lever at the same time.

- Mount front wheel stand (→ 161).

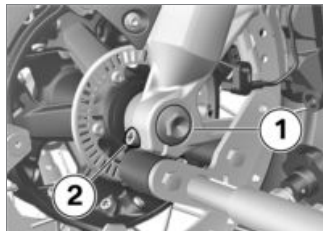

- Install screw **1** with specified torque. Brace quick-release axle on the right side at the same time.





Quick-release axle in telescopic fork

22 lb/ft (30 Nm)

- Tighten left-hand axle clamping screw **2** with appropriate torque.

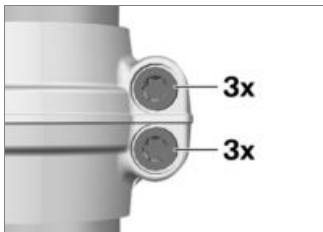



 Fork bridge, bottom at slider tube

Tightening sequence: Tighten the screws 6 times, alternating between one and the other each time

14 lb/ft (19 Nm)



- Tighten right-hand axle clamping screw **1** with appropriate torque.

 Clamping screw for quick-release axle in telescopic fork

14 lb/ft (19 Nm)

- Remove front-wheel stand.
- Slide the brake calipers on the left-hand and right-hand side onto the brake rotors.

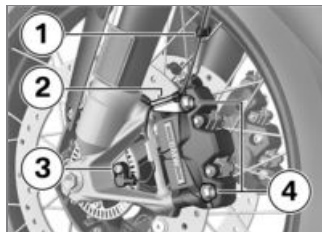

- Install mounting bolts **4** on left and right with appropriate torque.

 Brake caliper on telescopic forks

28 lb/ft (38 Nm)

- Remove adhesive tape from wheel rim.

## WARNING

### Brake pads do not contact the brake disc

Risk of accident due to delayed braking effect.

- Before driving off, check that the braking effect kicks in without any delay. ◀
- Engage the brakes repeatedly, continuing until the brake pads seat against the rotors.
- Insert the wheel speed sensor cable into the holding clips **1** and **2**.
- Insert the wheel speed sensor into the bore and install screw **3**.

 Wheel speed sensor on fork

Joint compound: Micro-encapsulated or medium-strength screw lock

 Wheel speed sensor on fork

6 lb/ft (8 Nm)

## Removing rear wheel

- Make sure ground is level and firm and place motorcycle on its center stand.
- Shift into first gear.

## CAUTION

### Hot exhaust system

Burn hazard

- Do not touch hot exhaust system. ◀
- Let rear muffler cool down.

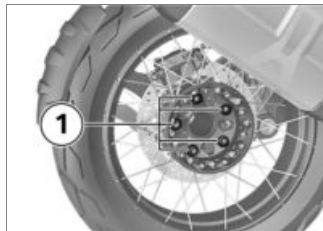

- Remove the screws **1** of the rear wheel while supporting the wheel.
- Roll rear wheel out toward rear.

## Installing rear wheel

### WARNING

#### Use of a wheel which does not comply with series specifications

Malfunctions during control interventions by ABS and ASC/DTC

- Please see the information on the effect of wheel sizes on the ABS and ASC/DTC chassis control systems at the beginning of this chapter.◀

### ATTENTION

#### Tightening of screwed connections with incorrect tightening torque

Damage or loosening of screwed connections

- Always have the tightening torques checked by a specialized workshop, preferably an authorized BMW Motorrad retailer.◀

- Place rear wheel on rear wheel support.

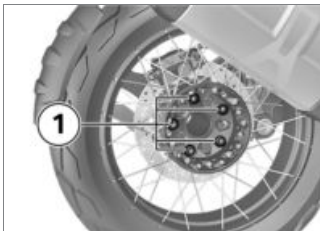

### WARNING

#### Mixed installation of wheel bolts for spoked wheels and cast wheels

Accident hazard

- Use only wheel bolts with the same permitted length code numbers.
- Do not lubricate the lug bolts.◀
- Install the lug bolts **1** with the specified torque.

 Tighten rear wheel on wheel flange

Tightening sequence: Tighten crosswise

44 lb/ft (60 Nm)

## Air filter

### Replacing air cleaner insert

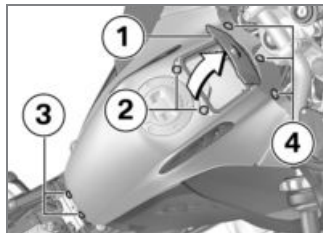

- Remove rider's seat (▶▶▶ 88).
- Open lid **1** of storage compartment.
- Remove screws **2**, **3** and **4**.
- Take off tank cover.



- Remove screws **1**.
- Take off air filter housing lid.

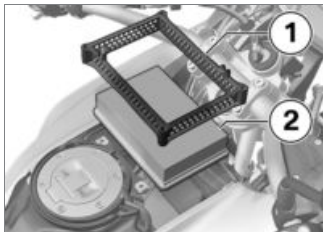

- Remove frame **1**.
- Remove air filter element **2**.

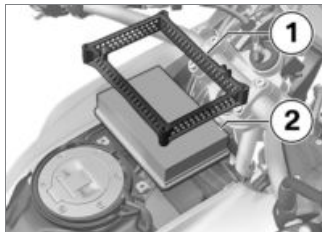

- Remove frame **1** and air filter element **2**.
- Insert new air filter element **2** and frame **1**.

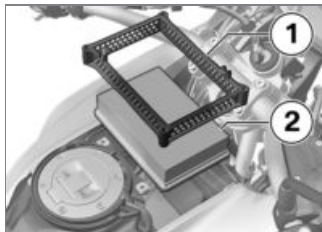

- Clean air filter element **2** or replace, if necessary.

- Insert air filter element **2** and frame **1**.

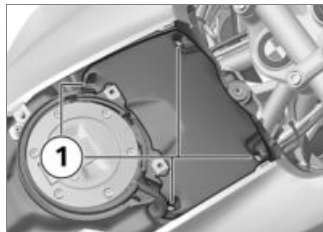

- Fit air filter housing lid.
- Install screws **1**.

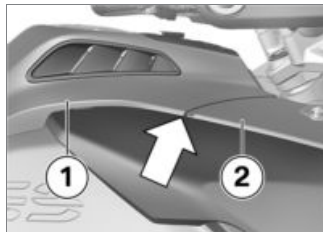

- Place tank cover **1** in position, taking care that the guide (**ar**-

**row)** is underneath the upper front wheel cover **2**.

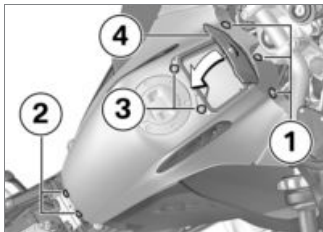

- Install screws **1**, **2** and **3**.
- Close lid **4** of storage compartment.
- Install rider's seat (→ 90).

## Light sources

### Replacing front and rear turn indicator light sources

- Park motorcycle, ensuring that support surface is firm and level.

- Turn off ignition.



- Remove screw **1**.



- Pull glass on screw connection side out of mirror housing.

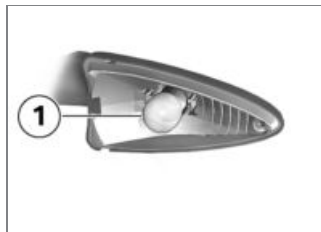

- Remove light source **1** from the mirror housing by turning it counterclockwise.

- Replace defective light source.

 Bulbs for flashing turn indicators, front

RY10W / 12 V / 10 W

 Bulbs for flashing turn indicators, rear

RY10W / 12 V / 10 W

- To protect glass on new bulb against contamination, always

use a clean, dry cloth to hold it; do not touch with bare fingers.

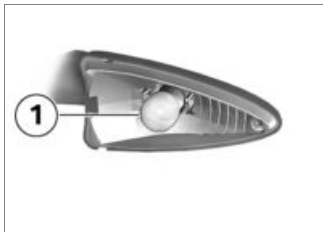

- Fit bulb **1** in mirror housing by turning it clockwise.



- Locate lens in mirror housing inner side first and close.



- Fit the screw **1**.

### Replacing LED tail light

The LED tail light can only be completely replaced.

- Please contact a specialist service facility for this purpose, preferably an authorized BMW Motorrad retailer.

### Replace LED headlights

- LED headlights can only be replaced as a complete unit. For details please contact a specialist service facility, preferably an authorized BMW Motorrad Retailer.

### Replace additional LED headlight

- with LED additional headlight<sup>OA</sup>

The LED additional headlights can only be completely replaced; it is not possible to replace individual LEDs.

Please contact a specialized workshop, preferably an authorized BMW Motorrad retailer.

### Jump-starting



#### ATTENTION

#### Current too high when jump-starting the motorcycle

Cable fire or damage to the motorcycle electronics

- Do not jump-start the motorcycle using the power socket, only via the battery terminal.◀

## ATTENTION

### Contact between crocodile clips of jump leads and motorcycle

Danger of short circuit

- Use jump leads fitted with fully insulated crocodile clips at both ends.◀

## ATTENTION

### Jump-starting with a voltage higher than 12 V

Damage to the motorcycle's electronics

- The battery of the donor motorcycle must have a voltage of 12 V.◀
- Park motorcycle, ensuring that support surface is firm and level.
- Remove battery cover (▣▣▣ 183).
- Do not disconnect the battery from the onboard electrical sys-

tem when jump-starting the engine.

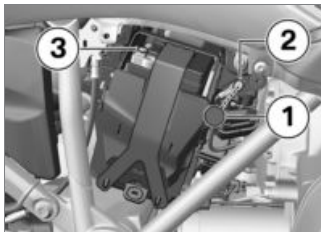

- Remove protective cap **1**.
- Begin by connecting the red jump lead to the positive battery connection point **2** on the drained battery and the other end to the positive terminal of the donor battery.
- Then clamp one end of the black jump lead to the donor battery's negative terminal **3** while connecting the other end to the drained battery's negative terminal.

- Allow engine on support motorcycle to run while jump-starting.
- Start engine of motorcycle with discharged battery in usual way; if engine does not start, wait a few minutes before repeating attempt in order to protect starter motor and donor battery.
- Allow both engines to idle for a few minutes before disconnecting jumper cables.
- Disconnect jumper cable from negative terminals first, then disconnect second cable from positive terminals.

## NOTICE

To start the engine, do not use start sprays or similar items.◀

- Install the protective cap.
- Installing battery cover (▣▣▣ 185).

## Battery

### Maintenance instructions

Correct battery maintenance combined with proper charging and storage procedures extends the battery's service life, and is also required for warranty claims. Compliance with the points below is important in order to maximize battery life:

- Keep the surface of the battery clean and dry.
- Do not open the battery.
- Do not top up with water.
- Be sure to read and comply with the instructions for charging the battery on the following pages.
- Do not turn the battery upside down.



#### ATTENTION

### Discharging of the connected battery by the vehicle electronics (e.g. clock)

Total discharge of battery leading to a rejection of warranty claims

- During riding breaks of more than 4 weeks, connect a trickle-charger to the battery.◀



#### NOTICE

BMW Motorrad has developed a trickle-charger specially designed for compatibility with the electronics of your motorcycle. Using this charger, you can keep the battery charged during long periods when the motorcycle is not being used without having to disconnect the battery from the motorcycle's onboard systems. Additional information is available at your authorized BMW Motorrad retailer.◀

## Charging connected battery



#### ATTENTION

### Charging the battery connected to the vehicle using the battery terminals

Damage to the motorcycle's electronics

- Disconnect the battery before charging on the battery terminals.◀



#### ATTENTION

### A fully discharged battery must be charged via a power socket or extra socket.

Damage to vehicle electronics

- A fully discharged battery (battery voltage less than 12 V, indicator lights and multifunction display remain off when ignition is switched on) must always be



charged directly at the poles of the **disconnected** battery.◀

## ATTENTION

### Unsuitable chargers connected to the power socket

Damage to charger and vehicle electronics

- Use suitable BMW chargers. The correct charger is available through your authorized BMW Motorrad retailer.◀
- Charge disconnected battery via onboard socket.

## NOTICE

The motorcycle's onboard electronics know when the battery is fully charged. The onboard socket is switched off when this happens.◀

- Comply with operating instructions of charger.

## NOTICE

If you are unable to charge the battery via the onboard socket, you may be using a charger that is not compatible with your motorcycle's electronics. In this case, charge the battery directly from the terminals of the battery disconnected from the vehicle.◀

### Charging disconnected battery

- Charge battery using a suitable charger.
- Comply with operating instructions of charger.
- Once battery is fully charged, disconnect charger's terminal clips from battery terminals.

## NOTICE

In the case of longer periods when the motorcycle is not being used, the battery must be

recharged regularly. See the instructions for caring for your battery. Always fully recharge the battery before returning it to use.◀

### Removing battery

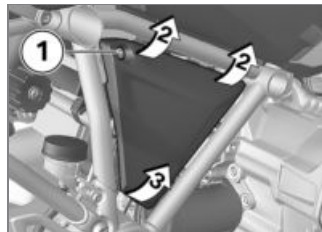

- Switch off ignition.
- Remove screw **1**.
- Pull battery cover at top slightly forward at the positions **2**.
- In order not to damage the battery cover and the mount, remove the battery cover upward at position **3**.

- with anti-theft alarm system (DWA)<sup>OE</sup>
- Switch off anti-theft alarm system if necessary.◀



- Release the battery earth lead **1** and rubber strap **2**.

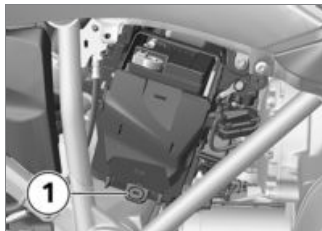

- Pull mounting plate on position **1** outwards and remove it upwards.
- Lift battery slightly out of holder sufficiently for positive terminal to be accessible.

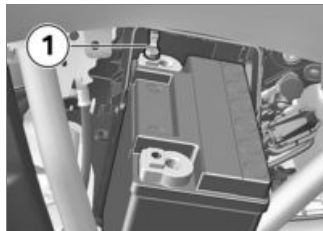

- Remove positive battery cable **1** and pull out battery.

### Install battery

#### NOTICE

If the 12-V battery is inserted incorrectly or the terminals reversed (e.g. when jump starting), it can blow the fuse for the alternator regulator.◀

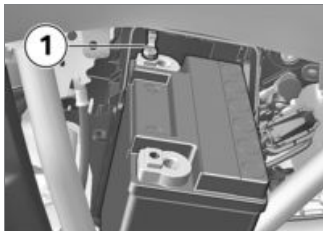

- Fasten positive battery cable **1**.
- Slide battery into holder.



- Fasten negative battery cable **1**.
- Fasten battery with rubber strap **2**.

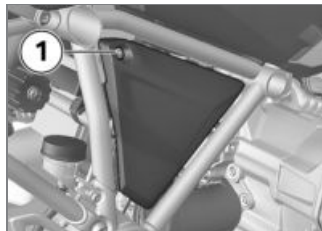

- Fit the screw **1**.
- Set clock (☰➔ 101).
- Set date (☰➔ 101).

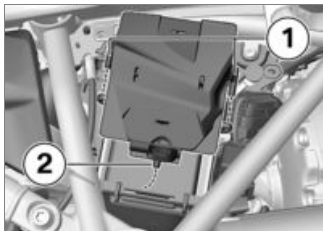

- First, insert mounting plate into supports **1**. Next, press it under the battery at position **2**.

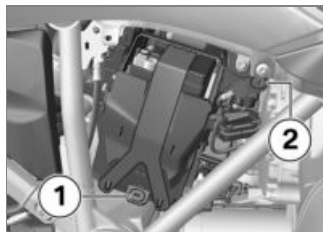

- Insert battery cover into mount **1** and press it into mount **2**.

## Fuses

### Replacing fuses

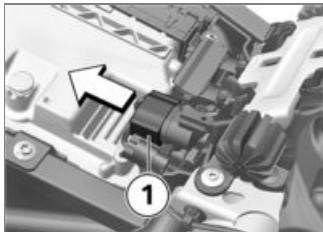

- Switch off ignition.
- Remove rider's seat (▣▣▣ 88).
- Detach plug **1**.

### ATTENTION

#### Bypassing defective fuses

Risk of short circuit and fire

- Do not bypass defective fuses.
- Replace defective fuses with new fuses.◀
- Consult the fuse assignment diagram and replace the defective fuse.



### NOTICE

If the fuses blow frequently, have the electrical system checked by an authorized specialized workshop, preferably an authorized BMW Motorrad retailer.◀

- Insert connector **1**.
- Install rider's seat (▣▣▣ 90).

## Fuse assignment

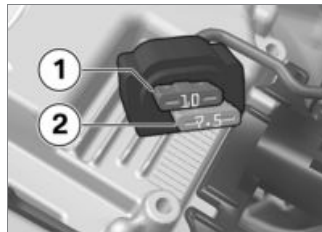

- |          |                                                                                                     |
|----------|-----------------------------------------------------------------------------------------------------|
| <b>1</b> | 10 A<br>Instrument cluster<br>Anti-theft alarm system (DWA)<br>Ignition switch<br>Diagnostic socket |
| <b>2</b> | 7.5 A<br>Multifunction switch, left<br>Tire Pressure Control (TCP/RDC)                              |

## Fuse for the alternator regulator

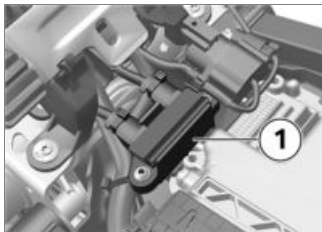

**1** 50 A  
Alternator regulator

## Data link connector Removing the diagnostic connector



**Incorrect procedure followed when disconnecting the data link connector for the On-Board Diagnostics.**

Motorcycle experiences malfunctions

- Only have the data link connector disconnected by a specialist workshop or other authorized persons during your next BMW Service appointment.
- Have the work performed by appropriately trained staff.
- Refer to the vehicle manufacturer specifications. ◀
- Remove battery cover (▶▶▶ 183).



- Press the hook **1** and lift out the data link connector **2**.

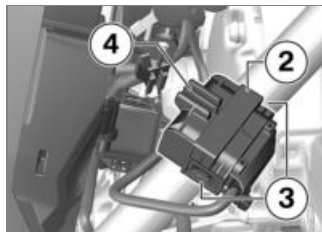

- Press the locking mechanisms **3** on both sides.
- Remove the data link connector **2** from the bracket **4**.
- » The diagnosis and information system interface can be connected at the diagnostic connector **2**.

## Secure the data link connector

- Disconnect the diagnosis and information system interface.

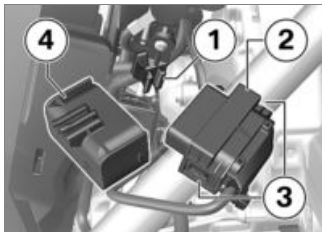

- Plug the seat data link connector **2** into the bracket **4**.
  - » The locking mechanisms **3** engage on both sides.
- Connect the bracket **4** to the mount **1**.



- Make sure that the hook **5** has engaged.
- Installing battery cover (▶▶▶ 185).

## **Accessories**

General notes.....	190
Onboard power sockets .....	190
Case.....	191
Topcase .....	193
Navigation system .....	195

## General notes

### CAUTION

#### Use of products from other manufacturers

Safety risk

- BMW Motorrad cannot examine or test each product of outside origin to ensure that it can be used on or in connection with BMW motorcycles without constituting a safety hazard. Nor is this guarantee provided when the official approval of a specific country has been granted. Tests conducted by these instances cannot make provision for all operating conditions experienced by BMW motorcycles and, consequently, they are not sufficient in some circumstances.
- Use only parts and accessories approved by BMW for your motorcycle. ◀

The safety, operation and suitability of the parts and accessory products have been thoroughly checked by BMW. Therefore, BMW assumes responsibility for these products. BMW will not be held liable for unapproved parts and accessory products of any kind.

Comply with legal requirements for any modifications. The motorcycle must not violate the regulations governing motorcycle approval for highway use applicable in your own country.

Your BMW Motorrad retailer offers you expert advice when choosing genuine BMW parts, accessories and other products. More information on the topic of accessories is available at:

**[bmw-motorrad.com/equipment](http://bmw-motorrad.com/equipment)**

## Onboard power sockets

### Connection of electrical devices

- The ignition must be switched on before electrical devices connected to the power sockets can be operated.

### Cable routing

- The cables from the onboard sockets to the auxiliary devices must be routed in such a way that they do not impede the rider.
- Cable routing must not restrict the steering angle and the handling characteristics.
- Cables must not be trapped.

### Automatic deactivation

- The onboard sockets are automatically switched off during starting.
- These sockets are switched off approx. 15 minutes after



switching off the ignition to reduce the strain on the onboard electrical system. Additional devices with low power consumption are possibly not detected by the vehicle electronics. In these cases, onboard sockets are already switched off shortly after the ignition is switched off.

- In case of insufficient battery voltage, the onboard sockets are switched off to maintain the ability to start the motorcycle.
- If the maximum loadability specified in the technical data is exceeded, the onboard sockets are switched off.

## Case

- with aluminum case<sup>OA</sup>

### Open case

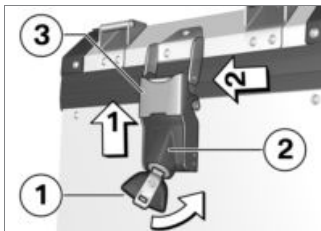

- Turn key **1** counterclockwise.

#### NOTICE

The case cover can be opened with both the left and the right latch. ◀

- Press lock housing **2** upward to release locking claw **3**.
- Pull locking claw **3** to side and open cover lid.

### Closing case

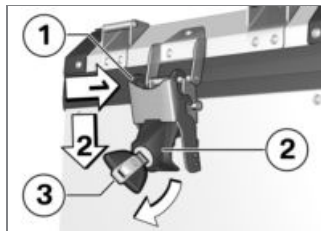

- Close case lid.
- Position locking claw **1** on lid.
- Press lock housing **2** downward while making sure that claw grips into lid.
- To lock, turn key **3** clockwise and remove.

### Remove case lid

- Open case (➡ 191).



- Detach lid retaining cable **1**.
- Close case lid.
- Open second latch of case lid.
- Remove case lid.

### Install case lid

- Lay case lid on case.
- Close one lock of case lid.
- Open case lid toward closed side.



- Hook in lid retaining cable **1**.
- Close case lid.
- Close second lock of case lid.

### Remove case

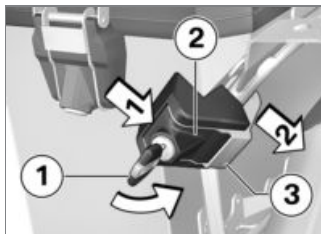

- Turn key **1** counterclockwise.

- Press lock housing **2** to side to release locking claw **3**.
- Pull locking claw **3** to side while holding case in place.
- Pull case forward as far as possible and remove to side.

### Mount case

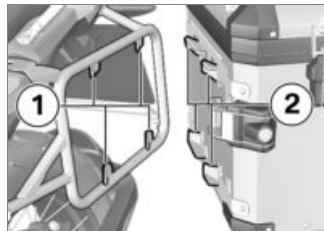

- Position pannier on pannier rack and slide rearwards so that the tabs on the pannier rack **1** engage with the lugs on the pannier **2**.

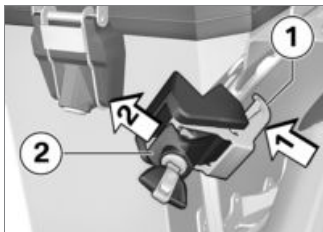



- Position locking claw **1** on case carrier while holding case in place.
- Press lock housing **2** to side while ensuring that claw grips around bracket.
- Turn key clockwise and remove.

## Maximum payload and top speed

Note the maximum permissible payload and the speed limit for riding with cases fitted, as stated on the label inside the case.

If you cannot find your combination of vehicle and

case on the sign, contact your BMW Motorrad partner. The following values apply for the combination described here:

	Maximum speed for riding with aluminum case
	max 112 mph (max 180 km/h)
	Payload per aluminum case
	max 22 lbs (max 10 kg)

## Topcase

– with aluminum topcase<sup>OA</sup>

## Opening topcase

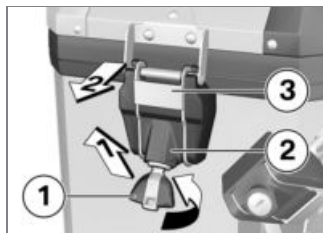

- Turn key **1** counterclockwise.
- Press lock housing **2** upward to release locking claw **3**.
- Pull locking claw **3** toward rear and open lid.

## Close topcase

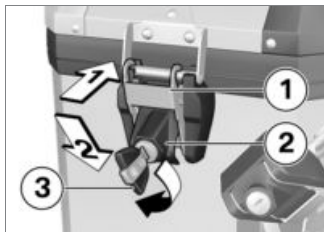

- Close topcase lid.
- Position locking claw **1** on lid.
- Press lock housing **2** downward while making sure that claw grips into lid.
- To lock, turn key **3** clockwise and remove.

## Remove topcase

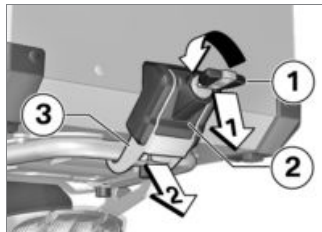

- Turn key **1** counterclockwise.
- Press lock housing **2** downward to release locking claw **3**.
- Pull locking claw **3** back.
- First pull topcase toward rear and then remove upward.

## Mount topcase

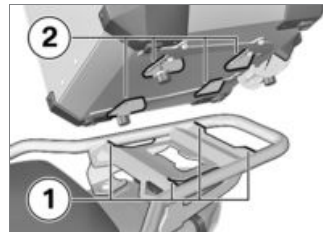

- Position topcase on topcase rack and slide forward so that tabs on topcase rack **1** engage with lugs on topcase **2**.

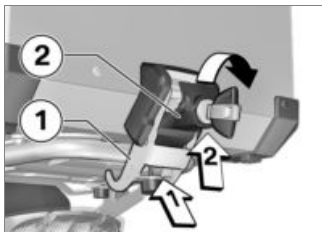



- Position locking claw **1** on topcase carrier.
- Press lock housing **2** upward while making sure that claw grips around carrier.
- To lock, turn key clockwise and remove.

## Maximum payload and top speed

Note the maximum permissible payload and the speed limit for riding with topcase fitted, as stated on the label inside the topcase.

If you cannot find your combination of motorcycle and topcase

on the sign, contact your authorized BMW Motorrad retailer. The following values apply for the combination described here:

	Maximum speed for riding with aluminum topcase
	max 112 mph (max 180 km/h)
	Payload of aluminum topcase
	max 11 lbs (max 5 kg)

## Navigation system

- with preparation for navigation system<sup>OE</sup>

## Securely fastening navigation device



### NOTICE

The navigation preparation is suitable as from the BMW Motorrad Navigator IV.◀



### NOTICE

The locking system of the Mount Cradle offers no protection against theft. Remove the navigation system and store in a safe place after every drive.◀

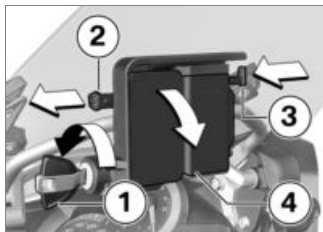

- Turn ignition key **1** counter-clockwise.
- Pull shut-off lock **2** to **left**.
- Press in locking device **3**.
- » Mount Cradle is unlocked and cover **4** can be removed with a rotating movement toward front.

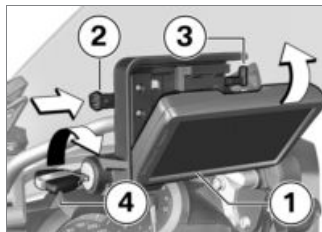

- Mount navigation device **1** in lower area and swing toward rear with a rotating movement.
- » Navigation device audibly engages.
- Slide shut-off lock **2** completely to **right**.
- » Locking device **3** is locked.
- Turn ignition key **4** clockwise.
- » Navigation device is locked and ignition key can be removed.

## Removing navigation device and installing cover



### ATTENTION

#### Dust and dirt on the contacts of the Mount Cradle

Damage to the contacts

- Reinstall the cover after end of each drive. ◀

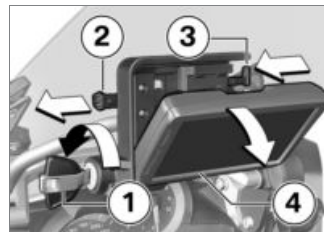

- Turn ignition key **1** counter-clockwise.
- Pull shut-off lock **2** completely to **left**.
- » Locking device **3** is unlocked.

- Slide locking device **3** completely to **left**.
- » Navigation device **4** is unlocked.
- Remove navigation device **4** downward with a tilting movement.

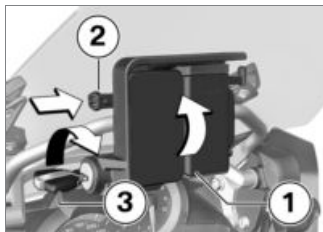

- Mount cover **1** in lower area and swing upward with a rotating movement.
- » Cover audibly engages.
- Slide shut-off lock **2** to **right**.
- Turn ignition key **3** clockwise.
- » Cover **1** is secured.

## Operating the navigation system

### NOTICE

The following description refers to the BMW Motorrad Navigator V and the BMW Motorrad Navigator VI. The BMW Motorrad Navigator IV does not offer all options described. ◀

### NOTICE

Only the latest version of the BMW Motorrad communication system is supported. A software update may be required for the BMW Motorrad communication system. In this case, please contact your authorized BMW Motorrad retailer. ◀

If the BMW Motorrad Navigator is installed and the operating focus is switched to the Navigator (➡ 97), several of its functions

can be operated directly from the handlebars.

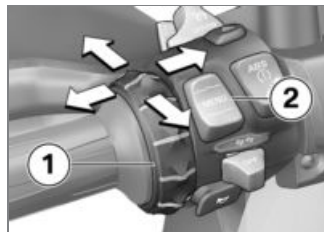

The navigation system is operated using the Multi-Controller **1** and the rocker button MENU **2**.

### Turning the Multi-Controller **1** up and down

On the compass and Mediaplayer pages: increase or reduce the volume for a BMW Motorrad communication system connected via Bluetooth. On the BMW special menu: select menu items.

### **Briefly tilting the Multi-Controller 1 to the left and right**

Change between the main pages of the Navigator:

- Map view
- Compass
- Mediaplayer
- BMW special menu
- My motorcycle page

### **Long-tilting the Multi-Controller 1 to the left and right**

Activate certain functions on the Navigator display. These functions are marked with a right arrow or a left arrow above the corresponding touch field.



The function is triggered by long actuation to the right.



The function is triggered by long actuation to the left.

### **Pressing the bottom rocker button MENU 2**

Change the operating focus to the Pure Ride view.

In detail, the following functions can be operated:

#### **Map view**

- Turning upward: zooms in on map section (Zoom in).
- Turn downward: zooms out of map section (Zoom out).

#### **Compass page**

- Turning increases or reduces volume of a BMW Motorrad communication system connected via Bluetooth.

#### **BMW special menu**

- Speak: Repeat last navigation announcement.

- Way point: Save current way point as favorite.
- Navigate home: Starts navigation to the home address (is grayed-out if no home address is set).
- Mute: Switch automatic navigation announcements (off: the top line in the display shows a crossed-out lip icon). Navigation announcements can still be output via "Speak". All other sound outputs remain switched on.
- Switching off display: Switch off display.
- Call home: Calls the home phone number stored in the navigator (only displayed when a communication system and a phone are connected).
- Detour: Activates the detour function (only displayed if a route is active).



- Skip: Skips the next way point (only displayed if route is provided with way points).

## My Motorcycle

- Turn: Changes the number of data displayed.
- Touching a data field on the display opens a menu for selecting the data.
- The values available for selection are dependent on the optional extras installed.

## Medioplayer

- Long actuation to left: Play previous title.
- Long actuation to right: Play next title.
- Turning increases or reduces volume of a BMW Motorrad communication system connected via Bluetooth.

## NOTICE

The Medioplayer function is only available when using a Bluetooth device as per A2DP standard, e.g., a BMW Motorrad communication system. ◀

## Warning and status messages



Warning and status displays of the motorcycle are indicated with a corresponding icon **1** at the upper left on the map view.

## NOTICE

If a BMW Motorrad communication system is connected, an acoustic signal is also sounds in case of a warning. ◀

If several warning messages are active, the number of messages is indicated below the warning triangle.

A list of all warning messages is opened by pressing on the warning triangle with more than one message.

Additional information is display when a message is selected.

## NOTICE

Detailed information cannot be displayed for all warnings. ◀

## Special functions

Due to integration of the BMW Motorrad Navigator there are differences from the descriptions in the instruction manual for the Navigator.

### Reserve fuel level warning

The settings for the fuel gage are not available because the reserve warning is transmitted from the vehicle to the Navigator. If the message is active, the nearest gas stations are shown when you press on the message.

### Time and date display

The Navigator transmits the time and date to the motorcycle. To transfer the time to the TFT display, the GPS synchronization function must also be activated in the Settings, System settings, Date and time menu.

## Security settings

The BMW Motorrad Navigator V and the BMW Motorrad Navigator VI can be secured against unauthorized use with a four-digit PIN (Garmin Lock). When this function is activated, once the Navigator GPS receiver is cradled on the motorcycle and the ignition is switched on you will receive a prompt asking whether the motorcycle should be added to the list of secure vehicles. If you confirm this question by answering "yes", then the Navigator will save the vehicle identification number of this vehicle.

A maximum of five VINs can be saved in this way.

A PIN entry will no longer be required when this Navigator is activated by turning on the ignition switch in any of these vehicles. Removing the Navigator from the motorcycle while it is switched

on will launch a new PIN request as a security measure.

## Screen brightness

Screen brightness is adjusted by the motorcycle while the unit is cradled. There is no need for manual input.

If desired, automatic setting can be switched off in the Navigator via the display settings.

## Care

Care products .....	202
Washing your motorcycle .....	202
Cleaning sensitive motorcycle parts .....	203
Paint care .....	204
Protective wax coating .....	204
Store motorcycle .....	205
Return motorcycle to use .....	205

## Care products

BMW Motorrad recommends that you use cleaning and care products available at your authorized BMW Motorrad retailer. BMW Care Products have been materials tested, laboratory tested, and field tested and provide optimum care and protection for the materials used in your vehicle.



### ATTENTION

#### Use of unsuitable cleaning and care agents

Damage to motorcycle parts

- Do not use any solvents such as nitro thinners, cold cleaners, fuel or similar, and do not use cleaning agents that contain alcohol. ◀



### ATTENTION

#### Use of highly acidic or alkaline cleaning agents

Damage to motorcycle parts

- Observe the dilution ratio on the packaging of the cleaning agents.
- Do not use highly acidic or alkaline cleaning agents. ◀

#### Washing your motorcycle

BMW Motorrad recommends that you use BMW Insect Remover to soften and wash off insects and stubborn dirt from painted parts before washing the motorcycle.

To prevent stains, do not wash the motorcycle immediately after it has been exposed to bright sunlight and do not wash it in the sun.

Make sure that the motorcycle is washed frequently, especially during the winter months. To remove road salt, clean the motorcycle with cold water immediately after completion of every trip.



### WARNING

#### Damp brake disks and brake pads after washing the motorcycle, after riding through water or in the rain

Poorer braking action, accident hazard

- Brake early until the brake rotors and brake pads are dry. ◀



### ATTENTION

#### Increased effect of salt caused by warm water

Corrosion

- Only use cold water to remove road salt. ◀



## ATTENTION

### Damage caused by high water pressure from high-pressure cleaners or steam-jet devices

Corrosion or short circuit, damage to labels, to seals, to hydraulic brake system, to the electrical system and the seat

- Exercise caution when using high-pressure or steam-jet devices. ◀



## NOTICE

Cases and topcases made of aluminum have no surface coating. The best possible appearance is preserved with the following care: Remove road salt and corrosive deposits immediately with cold water after completing the trip. ◀

## Cleaning sensitive motorcycle parts

### Plastics



## ATTENTION

### Use of unsuitable cleaning agents

Damage to plastic surfaces

- Do not use abrasive cleaners or cleaners containing alcohol or solvents.
- Do not use insect sponges or sponges with a hard surface. ◀

### Fairings and panels

Clean trim panel components with water and BMW Motorrad solvent cleaner.

### Windshields and lenses are manufactured in plastic

Clean off dirt and insects with a soft sponge and plenty of water.



## NOTICE

Soften stubborn dirt and dead insects by covering the affected areas with a wet cloth. ◀



Clean with water and sponge only.



Do not use chemical cleansers.

### TFT display

Clean the TFT display with warm water and detergent. Then dry with a clean cloth, e.g. a paper towel.

### Chrome

Carefully clean chrome parts with plenty of water and BMW Motorrad Care Products motorcycle cleaner. This is particularly important in the case of road salt.

Use BMW Motorrad metal polish for additional treatment.

## Radiator

Clean the radiator regularly to prevent overheating of the engine due to inadequate cooling. For example, use a garden hose with low water pressure.



### ATTENTION

#### Bending of radiator fins

Damage to radiator fins

- When cleaning, ensure that the cooler fins are not bent.◀

## Rubber

Treat rubber components with water or BMW rubber protection coating agent.



### ATTENTION

#### Use of silicone sprays for care of rubber seals

Damage to rubber seals

- Do not use silicone sprays or care products that contain silicone.◀

## Paint care

Washing the motorcycle regularly will help counteract the long-term effects of substances that damage the paint, especially if your motorcycle is ridden in areas with high air pollution or natural sources of dirt, such as tree resin or pollen.

At the same time, you should remove particularly aggressive materials immediately; otherwise changes in the paint and discoloration can occur. These include spilled fuel, oil, grease and brake fluid as well as bird droppings. It is recommended to use BMW Motorrad solvent cleaner and then apply BMW Motorrad high gloss polish to preserve the paint.

Contamination on the paint finish is particularly easy to see after the motorcycle has been washed. Remove this type of soiling with cleaning naphtha or spirit on a clean cloth or cotton ball. BMW Motorrad recommends removing tar stains with BMW tar remover. Then add a protective wax coating to the paint at these locations.

## Protective wax coating

Apply a preservative when water fails to bead up on the painted surface.

BMW Motorrad recommends BMW Motorrad high gloss polish or agents that contain carnauba or synthetic wax to protect the paint finish.

## Store motorcycle

- Clean motorcycle.
- Completely fill the motorcycle's fuel tank.
- Removing battery (➡ 183).
- Spray the brake and clutch lever, and the center and side stand pivots with a suitable lubricant.
- Protect metal and chrome-plated parts with an acid-free grease (Vaseline).
- Park the motorcycle in a dry space in such a way that both wheels are under no load (preferably by using the front and rear-wheel stands available from BMW Motorrad).

## Return motorcycle to use

- Remove the protective wax coating.
- Clean motorcycle.
- Install battery (➡ 184).
- Observe checklist (➡ 128).





## Technical data

Troubleshooting chart .....	208
Threaded fasteners .....	211
Fuel.....	214
Engine oil .....	215
Engine .....	215
Clutch .....	216
Transmission .....	216
Rear-wheel drive.....	217
Frame .....	218
Suspension .....	218
Brakes .....	219
Wheels and tires .....	220
Electrical system.....	222
Anti-theft alarm system .....	223
Dimensions .....	224

Weights.....	226
Performance data .....	226

## Troubleshooting chart

Engine does not start.

<b>Possible cause</b>	<b>Remedy</b>
Emergency on/off switch (kill switch)	Adjust emergency on/off switch (kill switch) to normal operating position.
Side stand extended and gear engaged	Retract side stand.
Gear engaged and clutch not disengaged	Place transmission in neutral or disengage clutch.
No fuel in tank	Refueling procedure (▮▮▮▮▶ 138).
Battery drained	Charging connected battery (▮▮▮▶ 182).
Overheating protection for starter motor has activated. Starter motor can only be actuated for a limited period.	Leave the starter motor to cool down for around 1 minute until it becomes available again.

Bluetooth connection is not established.

### **Possible cause**

### **Remedy**

Necessary pairing steps were not performed.

Refer to the operating instructions of the communication system for the necessary steps for pairing.

The communication system is not connected automatically despite successful pairing.

Switch off the communication system of the helmet and connect again after one to two minutes.

Too many Bluetooth devices are stored in the helmet.

Delete all pairing entries in the helmet (see the operating instructions of the communication system).

There are additional vehicles with Bluetooth-capable devices nearby.

Avoid simultaneous pairing with multiple vehicles.

Bluetooth connection is disrupted.

### **Possible cause**

### **Remedy**

Bluetooth connection to the mobile end device is interrupted.

Switch off energy saving mode.

Bluetooth connection to the helmet is interrupted.

Switch off the communication system of the helmet and connect again after one to two minutes.

Volume in the helmet cannot be adjusted.

Switch off the communication system of the helmet and connect again after one to two minutes.

Phone book is not displayed in the TFT display.

**Possible cause**

Phone book has not yet been transferred to the vehicle.

**Remedy**

During pairing to the mobile end device, confirm the transfer of the telephone data (☰➔ 111).

Active route guidance is not displayed in the TFT display.

**Possible cause**

Navigation from the BMW Motorrad Connected App was not transferred.

**Remedy**

Call up the BMW Motorrad Connected App on the connected mobile end device before riding.

Route guidance cannot be started.

Ensure that there is a data connection to the mobile end device and check the map data on the mobile end device.

## Threaded fasteners

Front wheel	Value	Valid
<b>Quick-release axle in telescopic fork</b>		
M12 x 20	22 lb/ft (30 Nm)	
<b>Fork bridge, bottom at slider tube</b>		
M8 x 35	<b>Tightening sequence: Tighten the screws 6 times, alternating between one and the other each time</b>	
	14 lb/ft (19 Nm)	
<b>Brake caliper on telescopic forks</b>		
M10 x 65	28 lb/ft (38 Nm)	
<b>Wheel speed sensor on fork</b>		
M6 x 16 Micro-encapsulated or medium-strength screw lock	6 lb/ft (8 Nm)	

<b>Rear wheel</b>	<b>Value</b>	<b>Valid</b>
<b>Tighten rear wheel on wheel flange</b>		
M10 x 1.25 x 40	<b>Tightening sequence: Tighten cross-wise</b>	
	44 lb/ft (60 Nm)	
<b>Mirrors</b>	<b>Value</b>	<b>Valid</b>
<b>Mirror (locknut) on adapter</b>		
M10 x 1.25	Left-hand thread, 16 lb/ft (22 Nm)	
<b>Adapter to clamping block</b>		
M10 x 14	18 lb/ft (25 Nm)	
<b>Gearshift lever</b>	<b>Value</b>	<b>Valid</b>
<b>Foot piece to gearshift lever</b>		
M6 x 20 micro-encapsulated	7 lb/ft (10 Nm)	

<b>Footbrake lever</b>	<b>Value</b>	<b>Valid</b>
<b>Foot piece on footbrake lever</b>		
M6 x 20 micro-encapsulated	7 lb/ft (10 Nm)	
<b>Footrests</b>	<b>Value</b>	<b>Valid</b>
<b>Clamping block on footrest hinge</b>		
M8 x 25	15 lb/ft (20 Nm)	
<b>Footrest on clamping block</b>		
M6 x 20 / M6 x 12	7 lb/ft (10 Nm)	
<b>Handlebars</b>	<b>Value</b>	<b>Valid</b>
<b>Clamping block (handlebar clamp) to fork bridge</b>		
M8 x 35	<b>Tightening sequence: tighten to block at front in direction of travel</b>	
	14 lb/ft (19 Nm)	

**Fuel**

Recommended fuel quality	Super unleaded (max. 15 % ethanol, E15) 89 AKI (95 ROZ/RON) 90 AKI
Alternative fuel quality	Normal unleaded (with performance penalty) (max. 15 % ethanol, E15) 87 AKI (91 ROZ/RON) 87 AKI
Usable fuel quantity	Approx. 7.9 gal (Approx. 30 l)
Reserve fuel quantity	Approx. 1.1 gal (Approx. 4 l)
Fuel consumption	50 mpg (4.75 l/100 km), according to WMTC
CO2 emissions	110 g/km, according to WMTC
Emission standard	EU 4



## Engine oil

Engine oil, capacity	max 1.1 gal (max 4 l), with filter replacement
Specification	SAE 5W-40, API SL/JASO MA2, Additives (for instance, molybdenum-based substances) are prohibited, because they would attack the coatings on engine components, BMW Motorrad recommends BMW Motorrad ADVANTEC Ultimate oil.
Engine oil, quantity for topping up	max 0.8 quarts (max 0.8 l), Difference between MIN and MAX

**BMW recommends** **ADVANTEC**  
ORIGINAL BMW ENGINE OIL

## Engine

Engine number location	Lower right of engine block beneath the starter
Engine type	A74B12M
Engine design	Air-cooled/liquid-cooled two-cylinder four-stroke opposed-twin engine with two overhead, spur-gear-driven camshafts, a counterbalance shaft, and variable intake camshaft control BMW Shift-Cam
Displacement	1254 cc (1254 cm <sup>3</sup> )
Cylinder bore	4 in (102.5 mm)

Piston stroke	3 in (76 mm)
Compression ratio	12.5:1
Rated output	136 hp (100 kW), at engine speed: 7750 min <sup>-1</sup>
Torque	105 lb/ft (143 Nm), at engine speed: 6250 min <sup>-1</sup>
Maximum engine speed	max 9000 min <sup>-1</sup>
Idle speed	1050 min <sup>-1</sup> , Engine at operating temperature

## Clutch

Clutch design	Multi-disk oil-bath clutch, slipper clutch
---------------	--------------------------------------------

## Transmission

Transmission design	6-speed transmission with helical cut dog ring gears
---------------------	------------------------------------------------------

Transmission gear ratios	1.000 (60:60 teeth), Primary gear ratio 1.650 (33:20 teeth), Transmission input ratio 2.438 (39:16 teeth), 1st gear 1.714 (36:21 teeth), 2nd gear 1.296 (35:27 teeth), 3rd gear 1.059 (36:34 teeth), 4th gear 0.943 (33:35 teeth), 5th gear 0.848 (28:33 teeth), 6th gear 1.061 (35:33 teeth), Transmission output ratio
--------------------------	--------------------------------------------------------------------------------------------------------------------------------------------------------------------------------------------------------------------------------------------------------------------------------------------------------------------------------------------------

## Rear-wheel drive

Type of final drive	Shaft drive with bevel gears
Type of rear suspension	Cast-aluminum single swing arm with BMW Motorrad Paralever
Gear ratio of final drive	2.91 (32:11 teeth)
Rear axle differential oil	SAE 70W-80 / hypoid axle G3

## Frame

Frame design	Steel-tube frame with partially self-supporting drive unit, steel-tube rear frame
Location of type plate	Frame at front left on steering head mount
Location of the vehicle identification number	Frame at front right on steering head

## Suspension

### Front wheel

Type of front suspension	BMW Telelever, upper fork bridge tilt decoupled, leading link mounted in engine and on telescopic fork, centrally positioned spring strut supported on leading link and frame
Design of the front-wheel suspension	Central spring strut with coil spring
– with Dynamic ESA <sup>OE</sup>	Central spring strut with coil spring and expansion tank, electrically adjustable rebound-stage and compression damping
Spring travel, front	8.3 in (210 mm), on wheel

## Rear wheel

Type of rear suspension	Cast-aluminum single swing arm with BMW Motorrad Paralever
Type of rear suspension	Central spring strut with coil spring, adjustable rebound-stage damping and spring preload
– with Dynamic ESA <sup>OE</sup>	Central spring strut with coil spring and expansion tank, electrically adjustable rebound-stage and compression damping, electrically adjustable spring preload
Spring travel at rear wheel	8.7 in (220 mm)

## Brakes

### Front wheel

Type of front brake	Hydraulically operated twin disk brake with 4-piston radial calipers and floating brake disks
Front brake pad material	Sintered metal
Front brake-disk thickness	min 0.16 in (min 4 mm), Wear limit
Free travel of brake actuation (Front wheel brake)	0.06...0.08 in (1.6...2.1 mm), at the piston

**Rear wheel**

Type of rear brake	Hydraulically operated disc brake with 2-piston floating caliper and fixed brake disc
Rear brake pad material	Sintered metal
Rear brake-disk thickness	min 0.18 in (min 4.5 mm), Wear limit
Blow-by clearance of footbrake lever	0.04...0.06 in (1...1.5 mm), Between frame and footbrake lever

**Wheels and tires**

Recommended tire combinations	An overview of the current tire approvals is available from your authorized BMW Motorrad retailer or on the Internet at <a href="http://bmw-motorrad.com">bmw-motorrad.com</a> .
Speed category of front/rear tires	V, minimum requirement: 149 mph (240 km/h)

**Front wheel**

Front wheel design	Cross spoke wheel
Front-wheel rim size	3.0"x19"
Front tire designation	120/70 - R19
Load index for front tire	At least 60
Permissible front wheel load	max 419 lbs (max 190 kg)
Permissible front-wheel imbalance	max 0.2 oz (max 5 g)

**Rear wheel**

Rear wheel design	Cross spoke wheel
Rear-wheel rim size	4.50"x17"
Rear tire designation	170/60 - R17
Load index for rear tire	At least 72
Permissible rear wheel load	max 705 lbs (max 320 kg)
Permissible rear-wheel imbalance	max 1.6 oz (max 45 g)

**Tire inflation pressures**

Tire pressure, front	36.3 psi (2.5 bar), with tire cold
Tire pressure, rear	42.1 psi (2.9 bar), with tire cold

## Electrical system

Electrical rating of onboard sockets	max 5 A, all onboard sockets together
Fuse carrier 1	10 A, Slot 1: instrument cluster, anti-theft alarm system (DWA), ignition lock, diagnostic socket 7.5 A, Slot 2: left multifunction switch, Tire Pressure Control (TCP/RDC)
Fuse carrier	50 A, Fuse 1: Voltage regulator
<b>Battery</b>	
Battery design	AGM battery (Absorbent Glass Mat)
– with HP battery <sup>OE</sup>	Lithium ion battery
Battery voltage	12 V
– with HP battery <sup>OE</sup>	12 V
Battery capacity	12 Ah
– with HP battery <sup>OE</sup>	10 Ah
<b>Spark plugs</b>	
Spark plugs, manufacturer and designation	NGK LMAR8AI-10



**Bulbs**

Bulb for high-beam headlight	LED
Bulbs for low-beam headlight	LED
Bulb for parking light	LED
Bulb for taillight/brake light	LED
Bulbs for flashing turn indicators, front	RY10W / 12 V / 10 W
Bulbs for flashing turn indicators, rear	RY10W / 12 V / 10 W

**Anti-theft alarm system**

Activation time	Approx. 30 s
Alarm duration	Approx. 26 s
Battery type	CR 123 A

## Dimensions

Motorcycle length	89.4 in (2270 mm), over splash guard
Motorcycle height	57.5...59.8 in (1460...1520 mm), over windshield, at DIN unladen weight
– with Style HP <sup>OE</sup>	57.1...59.4 in (1450...1510 mm), over windshield, at DIN unladen weight
– with Style HP <sup>OE</sup> – with passenger package <sup>OE</sup>	57.5...59.8 in (1460...1520 mm), over windshield, at DIN unladen weight
– with lowered <sup>OE</sup>	55.7...58.1 in (1415...1475 mm), over windshield, at DIN unladen weight
Motorcycle width	37.5 in (952 mm), with mirrors 38.6 in (980 mm), with hand protector
Driver's seat height	35...35.8 in (890...910 mm), without rider at unladen weight
– with Style HP <sup>OE</sup>	34.6 in (880 mm), without driver at DIN unladen weight
– with Style HP <sup>OE</sup> – with Rallye seat <sup>OA</sup>	35.4 in (900 mm), without driver at DIN unladen weight
– with Style HP <sup>OE</sup> – with passenger package <sup>OE</sup>	35...35.8 in (890...910 mm), without driver at DIN unladen weight

– with lowered <sup>OE</sup>	33.1...33.9 in (840...860 mm), without driver at DIN unladen weight
– with lowered <sup>OE</sup> – with seat, black <sup>OE</sup>	32.3...33.1 in (820...840 mm), without driver at DIN unladen weight
Rider's inside-leg arc, heel to heel	76.8...78.3 in (1950...1990 mm), without rider at unladen weight
– with Style HP <sup>OE</sup> – with seat, low <sup>OA</sup>	75.6 in (1920 mm), without rider at unladen weight
– with Style HP <sup>OE</sup> – with Rallye seat <sup>OA</sup>	77.2 in (1960 mm), without rider at unladen weight
– with Style HP <sup>OE</sup> – with passenger package <sup>OE</sup>	76.8...78.3 in (1950...1990 mm), without rider at unladen weight
– with lowered <sup>OE</sup>	72.8...74.4 in (1850...1890 mm), without rider at unladen weight
– with lowered <sup>OE</sup> – with seat, black <sup>OE</sup>	71.3...72.8 in (1810...1850 mm), without rider at unladen weight

## Weights

Vehicle curb weight	591 lbs (268 kg), DIN unladen weight, ready for road, fuel tank 90 % full, without OE
Permissible gross weight	1069 lbs (485 kg)
Maximum payload	478 lbs (217 kg)

## Performance data

Top speed	>124 mph (>200 km/h)
– with aluminum case <sup>OA</sup>	112 mph (180 km/h)
– with aluminum topcase <sup>OA</sup>	112 mph (180 km/h)

## Service

Reporting safety defects .....	228
BMW Motorrad Service .....	229
BMW Motorrad Service History ....	229
BMW Motorrad Mobility Services .....	230
Maintenance procedures .....	230
BMW Service .....	230
Maintenance schedule .....	233
Maintenance confirmations .....	234
Service confirmations .....	248

## Reporting safety defects

If you think that your motorcycle has a fault which may cause an accident, injury or death, you must inform the NHTSA (National Highway Traffic Safety Administration) immediately and BMW of North America, LLC.

If the NHTSA receives other similar complaints, it may open an investigation. If it finds that a safety defect exists in a group of vehicles, the NHTSA may order the manufacturer to perform a recall and remedy campaign. However, the NHTSA cannot become involved in individual problems between you, your authorized BMW Motorrad retailer, or BMW of North America, LLC.

You can contact the NHTSA by calling the Vehicle Safety Hotline on 1-888-327-4236 (Teletypewriter TTY for the hearing impaired: 1-800-424-9153) for free, by visiting the website at <http://www.safercar.gov> or by writing to Administrator, NHTSA, 400 Seventh Street, SW., Washington, DC 20590. Further information on vehicle safety is available at <http://www.safercar.gov>.

## BMW Motorrad Service

With its worldwide retailer network, BMW Motorrad can attend to you and your motorcycle in over 100 countries around the globe. Authorized BMW Motorrad retailers have the technical information and expertise needed to conduct reliable service and repairs covering every aspect of your BMW.

You will find the nearest authorized BMW Motorrad retailer to you at our website:

[bmw-motorrad.com](http://bmw-motorrad.com)

### WARNING

#### **Improperly performed maintenance and repair work**

Accident hazard caused by subsequent damage

- BMW Motorrad recommends having corresponding work on the motorcycle carried out

by a specialized workshop, preferably by an authorized BMW Motorrad retailer. ◀

To ensure that your BMW consistently remains in optimal condition BMW Motorrad urges you to observe the recommended service intervals. Have all maintenance and repair work confirmed in the "Service" chapter in this manual. Documentation confirming regular maintenance is essential for generous treatment of claims submitted after the warranty period has expired (goodwill).

You can obtain information on the contents of the BMW Services from your BMW Motorrad retailer.

## BMW Motorrad Service History

### Entries

Maintenance work that has been performed is recorded in the diagnostics and information system. Like a Service Booklet, these entries provide proof of regular maintenance.

If an entry is made in the vehicle's electronic Service Manual, service-related data is stored on the central IT systems of BMW AG in Munich, Germany.

When there is a change in vehicle owner, the data entered in the electronic Service History can also be viewed by the new vehicle owner. A BMW Motorrad retailer or specialist workshop can view the data entered in the electronic Service Manual.

## Objection

At the BMW Motorrad retailer or specialist workshop, the vehicle owner can object to the entry of data in the electronic Service Manual with the related storage of data in the vehicle and the transfer of data to the vehicle manufacturer during his time as the vehicle owner. In this case, no entry is made in the vehicle's electronic Service Manual.

## BMW Motorrad Mobility Services

The BMW Motorrad Mobility Services furnish you and your new BMW motorcycle with extra security by offering a wide array of assistance services in the event of a breakdown (BMW Roadside Assistance, breakdown assistance, vehicle recovery and retrieval, etc.).

Contact your authorized BMW Motorrad retailer for additional

information on available mobility-maintenance services.

## Maintenance procedures

### BMW Pre-Delivery Check

The BMW pre-delivery check is carried out by your authorized BMW Motorrad retailer before it turns over the vehicle to you.

### BMW Running-in Check

The BMW running-in check must be carried out between 300 mls (500 km) and 750 mls (1200 km).

## BMW Service

BMW Service is carried out once a year. The scope of the services performed may be dependent on the motorcycle owner and the mileage driven. Your BMW Motorrad retailer confirms that the service has been per-

formed and enters the date for the next service.

For riders who drive long distances annually, it may be necessary to come in for service before the entered date. In this case a corresponding maximum odometer reading will also be entered in the confirmation of service. If this odometer reading is reached before the next service date, service must be performed sooner.

The service interval indicator in the display reminds you of the next service date approx. one month or 620 miles (1000 km) before the entered values.

More information on the topic of service is available at:

**[bmw-motorrad.com/service](http://bmw-motorrad.com/service)**

The required scope of maintenance work for your motorcycle can be found in the following maintenance schedule:







## Maintenance schedule

- 1** BMW Running-in check (including oil change)
- 2** BMW Service Standard Scope
- 3** Engine oil change with filter
- 4** Oil change in the rear bevel gears
- 5** Check valve clearance
- 6** Replace all spark plugs
- 7** Replace air cleaner insert
- 8** Check or replace the air filter element
- 9** Change brake fluid in entire system
  - a** annually or every 6000 miles (10000 km) (whichever comes first)
  - b** annually or every 12000 miles (20000 km) (whichever comes first)
  - c** when used off-road, annually or every 6000 miles (10000 km) (whichever comes first)
  - d** for the first time after one year, then every two years

## Maintenance confirmations

### BMW Service standard scope

The repair procedures belonging to the BMW Service standard package are listed below. The actual maintenance work applicable for your vehicle may differ.

- Performing the vehicle test using the BMW Motorrad diagnosis system
- Visual inspection of the clutch system
- Visual inspection of the brake lines, brake hoses, and connections
- Checking front brake pads and brake disks for wear
- Checking the front wheel brake fluid level
- Checking the rear brake pads and brake disk for wear
- Checking the rear wheel brake fluid level
- Checking coolant level
- Check side stand for ease of movement
- Checking the center stand for ease of movement
- Checking the tire pressure and tread depth
- Check the tension of the spokes and tighten as needed
- Checking the lighting and signal system
- Functional check for engine starting suppression
- Final inspection and road safety check
- Set the service date and remaining distance using the BMW Motorrad diagnostic system
- Checking charging state of battery
- Confirm the BMW service in the vehicle literature

## **BMW pre-delivery check**

performed

on \_\_\_\_\_

\_\_\_\_\_  
Stamp, signature

## **BMW Running-in Check**

performed

on \_\_\_\_\_

at km \_\_\_\_\_

Next service

latest

on \_\_\_\_\_

or, if reached earlier

at km \_\_\_\_\_

\_\_\_\_\_  
Stamp, signature

**BMW Service**

performed

on \_\_\_\_\_

at km \_\_\_\_\_

Next service

latest

on \_\_\_\_\_

or, if reached earlier

at km \_\_\_\_\_

Work performed

BMW Service

Engine oil change with filter

Oil change in rear bevel gears

Checking valve clearance

Replacing all spark plugs

Replacing air cleaner element

Checking or replacing air cleaner element (maintenance)

Changing brake fluid in entire system

Yes

No

Information

-----

-----

-----

-----

-----

-----

-----

-----

\_\_\_\_\_

Stamp, signature

**BMW Service**

performed

on \_\_\_\_\_

at km \_\_\_\_\_

Next service

latest

on \_\_\_\_\_

or, if reached earlier

at km \_\_\_\_\_

Work performed

BMW Service

Engine oil change with filter

Oil change in rear bevel gears

Checking valve clearance

Replacing all spark plugs

Replacing air cleaner element

Checking or replacing air cleaner element (maintenance)

Changing brake fluid in entire system

Yes No

Information

-----  
-----  
-----  
-----  
-----  
-----  
-----  
-----

\_\_\_\_\_  
Stamp, signature

**BMW Service**

performed

on \_\_\_\_\_

at km \_\_\_\_\_

Next service

latest

on \_\_\_\_\_

or, if reached earlier

at km \_\_\_\_\_

Work performed

BMW Service

Engine oil change with filter

Oil change in rear bevel gears

Checking valve clearance

Replacing all spark plugs

Replacing air cleaner element

Checking or replacing air cleaner element (maintenance)

Changing brake fluid in entire system

Yes

No

Information

-----

-----

-----

-----

-----

-----

-----

-----

\_\_\_\_\_

Stamp, signature



**BMW Service**

performed

on \_\_\_\_\_

at km \_\_\_\_\_

Next service

latest

on \_\_\_\_\_

or, if reached earlier

at km \_\_\_\_\_

Work performed

BMW Service

Engine oil change with filter

Oil change in rear bevel gears

Checking valve clearance

Replacing all spark plugs

Replacing air cleaner element

Checking or replacing air cleaner element (maintenance)

Changing brake fluid in entire system

Yes No

Information

-----  
-----  
-----  
-----  
-----  
-----  
-----  
-----

\_\_\_\_\_  
Stamp, signature

**BMW Service**

performed

on \_\_\_\_\_

at km \_\_\_\_\_

Next service

latest

on \_\_\_\_\_

or, if reached earlier

at km \_\_\_\_\_

Work performed

BMW Service

Engine oil change with filter

Oil change in rear bevel gears

Checking valve clearance

Replacing all spark plugs

Replacing air cleaner element

Checking or replacing air cleaner element (maintenance)

Changing brake fluid in entire system

Yes

No

Information

-----

-----

-----

-----

-----

-----

-----

-----

\_\_\_\_\_

Stamp, signature

**BMW Service**

performed

on \_\_\_\_\_

at km \_\_\_\_\_

Next service

latest

on \_\_\_\_\_

or, if reached earlier

at km \_\_\_\_\_

Work performed

BMW Service

Engine oil change with filter

Oil change in rear bevel gears

Checking valve clearance

Replacing all spark plugs

Replacing air cleaner element

Checking or replacing air cleaner ele-

ment (maintenance)

Changing brake fluid in entire system

Yes

No

Information

-----  
-----  
-----  
-----  
-----  
-----  
-----  
-----

\_\_\_\_\_  
Stamp, signature

**BMW Service**

performed

on \_\_\_\_\_

at km \_\_\_\_\_

Next service

latest

on \_\_\_\_\_

or, if reached earlier

at km \_\_\_\_\_

Work performed

BMW Service

Engine oil change with filter

Oil change in rear bevel gears

Checking valve clearance

Replacing all spark plugs

Replacing air cleaner element

Checking or replacing air cleaner element (maintenance)

Changing brake fluid in entire system

Yes

No

Information

-----

-----

-----

-----

-----

-----

-----

-----

\_\_\_\_\_

Stamp, signature

**BMW Service**

performed

on \_\_\_\_\_

at km \_\_\_\_\_

Next service

latest

on \_\_\_\_\_

or, if reached earlier

at km \_\_\_\_\_

Work performed

BMW Service

Engine oil change with filter

Oil change in rear bevel gears

Checking valve clearance

Replacing all spark plugs

Replacing air cleaner element

Checking or replacing air cleaner element (maintenance)

Changing brake fluid in entire system

Yes No

Information

-----  
-----  
-----  
-----  
-----  
-----  
-----  
-----

\_\_\_\_\_  
Stamp, signature

**BMW Service**

performed

on \_\_\_\_\_

at km \_\_\_\_\_

Next service

latest

on \_\_\_\_\_

or, if reached earlier

at km \_\_\_\_\_

Work performed

BMW Service

Engine oil change with filter

Oil change in rear bevel gears

Checking valve clearance

Replacing all spark plugs

Replacing air cleaner element

Checking or replacing air cleaner element (maintenance)

Changing brake fluid in entire system

Yes

No

Information

-----

-----

-----

-----

-----

-----

-----

-----

\_\_\_\_\_

Stamp, signature

**BMW Service**

performed

on \_\_\_\_\_

at km \_\_\_\_\_

Next service

latest

on \_\_\_\_\_

or, if reached earlier

at km \_\_\_\_\_

Work performed

BMW Service

Engine oil change with filter

Oil change in rear bevel gears

Checking valve clearance

Replacing all spark plugs

Replacing air cleaner element

Checking or replacing air cleaner element (maintenance)

Changing brake fluid in entire system

Yes No

Information

-----  
-----  
-----  
-----  
-----  
-----  
-----  
-----

\_\_\_\_\_  
Stamp, signature

**BMW Service**

performed

on \_\_\_\_\_

at km \_\_\_\_\_

Next service

latest

on \_\_\_\_\_

or, if reached earlier

at km \_\_\_\_\_

Work performed

BMW Service

Engine oil change with filter

Oil change in rear bevel gears

Checking valve clearance

Replacing all spark plugs

Replacing air cleaner element

Checking or replacing air cleaner element (maintenance)

Changing brake fluid in entire system

Yes

No

Information

-----

-----

-----

-----

-----

-----

-----

-----

\_\_\_\_\_

Stamp, signature



**BMW Service**

performed

on \_\_\_\_\_

at km \_\_\_\_\_

Next service

latest

on \_\_\_\_\_

or, if reached earlier

at km \_\_\_\_\_

Work performed

BMW Service

Engine oil change with filter

Oil change in rear bevel gears

Checking valve clearance

Replacing all spark plugs

Replacing air cleaner element

Checking or replacing air cleaner element (maintenance)

Changing brake fluid in entire system

Yes No

Information

-----  
-----  
-----  
-----  
-----  
-----  
-----  
-----

\_\_\_\_\_  
Stamp, signature

## Service confirmations

The table serves to provide evidence of maintenance and repair work, as well as installed optional accessories and special campaigns performed.

Work performed	at km	Date

Work performed	at km	Date



## Appendix

Certificate for Electronic Immobilizer .....	252
Certificate for Keyless Ride .....	254
Certificate for Tire Pressure Control .....	256
Certificate for TFT instrument cluster .....	257

## FCC Approval

### Ring aerial in the ignition switch



To verify the authorization of the ignition key, the electronic immobilizer exchanges information with the ignition key via the ring aerial.

This device complies with Part 15 of the FCC rules. Operation is subject to the following two conditions:

- (1) This device may not cause harmful interference, and
- (2) this device must accept any interference received, including interference that may cause undesired operation.



Any changes or modifications not expressly approved by the party responsible for compliance could void the user's authority to operate the equipment. ◀

## Approbation de la FCC

### Antenne annulaire présente dans le commutateur d'allumage



Pour vérifier l'autorisation de la clé de contact, le système d'immobilisation électronique échange des

informations avec la clé de contact via l'antenne annulaire.

Le présent dispositif est conforme à la partie 15 des règles de la FCC. Son utilisation est soumise aux deux conditions suivantes :

- (1) Le dispositif ne doit pas produire d'interférences nuisibles, et
- (2) le dispositif doit pouvoir accepter toutes les interférences extérieures, y compris celles qui pourraient provoquer une activation inopportune.



Toute modification qui n'aurait pas été approuvée expressément par l'organisme responsable de l'homologation peut annuler l'autorisation accordée à l'utilisateur pour utiliser le dispositif. ◀

## Certifications

---

### BMW Keyless Ride ID Device



#### USA, Canada

Product name: BMW Keyless Ride ID Device  
FCC ID: YGOHUF5750  
IC: 4008C-HUF5750

#### Canada:

Operation is subject to the following two conditions:

- (1) This device may not cause harmful interference, and
- (2) this device must accept any interference received, including interference that may cause undesired operation.

#### USA:

This device complies with Part 15 of the FCC rules. Operation is subject to the following two conditions:

- (1) This device may not cause harmful interference, and
- (2) this device must accept any interference received, including interference that may cause undesired operation.



Any changes or modifications not expressly approved by the party responsible for compliance could void the user's authority to operate the equipment.



# Declaration Of Conformity

---

We declare under our responsibility that the product

## **BMW Keyless Ride ID Device (Model: HUF5750)**

complies with the appropriate essential requirements of the article 3 of the R&TIE and the other relevant provisions, when used for its intended purpose. Applied Standards:

1. Health and safety requirements contained in article 3 (1) a)
  - EN 60950-1:2006+A11:2009+A1:2010+A12:2011; Information technology equipment- Safety
2. Protection requirements with respect to electromagnetic compatibility article 3 (1) b)
  - EN 301 489-1 (V1 .9.2, 09/2011 ), Electromagnetic compatibility and radio spectrum matters (ERM); Electromagnetic compatibility (EMC) standard for radio equipment and services; Part 1: Common technical requirements
  - EN 301 489-3 (V1.4.1, 08/2002) Electromagnetic compatibility and radio spectrum matters (ERM); Electromagnetic compatibility (EMC) standard for radio equipment and services; Part 3: Specific conditions for short range devices (SRD) operating on frequencies between 9 kHz and 40 GHz
3. Means of the efficient use of the radio frequency spectrum article 3 (2)
  - EN 300 220-1 & -2 (V2.4.1, 05/2012), electromagnetic compatibility and radio spectrum matters (ERM); Short range devices (SRD); Radio equipment to be used in the 25 MHz to 1000 MHz frequency range with power levels ranging up to 500 mW;  
Part 1: Technical characteristics and test methods.  
Part 2: Harmonized EN covering essential requirements under article 3.2 of the R&TIE directive

The product is labeled with the CE marking: **CE**

Velbert, October 15<sup>th</sup>, 2013

---

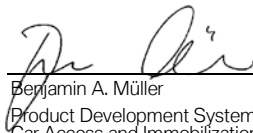

---

Benjamin A. Müller  
Product Development Systems  
Car Access and Immobilization – Electronics  
Huf Hülsbeck & Fürst GmbH & Co. KG  
Steeger Straße 17, D-42551 Velbert

## Certification Tire Pressure Control (TPC)

---

FCC ID: MRXBC54MA4  
IC: 2546A-BC54MA4

FCC ID: MRXBC5A4  
IC: 2546A-BC5A4

This device complies with Part 15 of the FCC Rules and with Industry Canada license-exempt RSS standard(s).

Operation is subject to the following two conditions:

- (1) This device may not cause harmful interference, and
- (2) This device must accept any interference received, including interference that may cause undesired operation.

Le présent appareil est conforme aux CNR d'Industrie Canada applicables aux appareils radio exempts de licence. L'exploitation est autorisée aux deux conditions suivantes:

- (1) l'appareil ne doit pas produire de brouillage, et
- (2) l'utilisateur de l'appareil doit accepter tout brouillage radioélectrique subi, même si le brouillage est susceptible d'en compromettre le fonctionnement.

**WARNING:** Changes or modifications not expressly approved by the party responsible for compliance could void the user's authority to operate the equipment. The term "IC:" before the radio certification number only signifies that Industry Canada technical specifications were met.

# Declaration of Conformity

## Radio equipment TFT instrument cluster

For all Countries without EU

### Technical information

BT operating frq. Range: 2402 – 2480 MHz

BT version: 4.2 (no BTLE)

BT output power: < 4 dBm

WLAN operating frq. Range: 2412 – 2462 MHz

WLAN standards: IEEE 802.11 b/g/n

WLAN output power: < 20 dBm

### Manufacturer and Address

Manufacturer:

Robert Bosch Car Multimedia GmbH

Adress: Robert Bosch Str. 200,

31139 Hildesheim, GERMANY

### Turkey

Robert Bosch Car Multimedia GmbH, ICC6.5in tipi telsiz sisteminin 2014/53/EU nolu yönetmeliğe uygun olduğunu beyan eder. AB Uygunluk Beyanı'nın tam metni, aşağıdaki internet adresinden görülebilir: <http://cert.bosch-carmultimedia.net>

### Brazil

Este equipamento opera em caráter secundário, isto é, não tem direito a proteção contra interferência prejudicial, mesmo de estações do mesmo tipo, e não pode causar interferência a sistemas operando em caráter primário.

## **Canada**

This device complies with Industry Canada's licence-exempt RSSs and part 15 of the FCC Rules. Operation is subject to the following two conditions:

(1) this device may not cause interference, and  
(2) this device must accept any interference, including interference that may cause undesired operation of the device.

Changes or modifications not expressly approved by the party responsible for compliance could void the user's authority to operate the equipment.

Le présent appareil est conforme aux CNR d'Industrie Canada applicables aux appareils radio exempts de licence. L'exploitation est autorisée aux deux conditions suivantes : (1) l'appareil ne doit pas produire de brouillage, et (2) l'appareil doit accepter tout brouillage radioélectrique subi, même si le brouillage est susceptible d'en compromettre le fonctionnement.

## **Mexico**

La operación de este equipo está sujeta a las siguientes dos condiciones:

(1) es posible que este equipo o dispositivo no cause interferencia perjudicial y  
(2) este equipo o dispositivo debe aceptar cualquier interferencia, incluyendo la que pueda causar su operación no deseada.

## **Taiwan, Republic of**

根據 NCC 低功率電波輻射性電機管理辦法 規定：  
第十二條

經型式認證合格之低功率射頻電機，非經許可，公司、商號或使用者均不得擅自變更頻率、加大功率或變更原設計之特性及功能。

### 第十四條

低功率射頻電機之使用不得影響飛航安全及干擾合法通信；經發現有干擾現象時，應立即停用，並改善至無干擾時方得繼續使用。

前項合法通信，

指依電信法規定作業之無線電通信。

低功率射頻電機須忍受合法通信或工業、科學及醫療用電波輻射性電機設備之干擾。

## Thailand

เครื่องโทรคมนาคมและอุปกรณ์นี้

มีความสอดคล้องตามข้อกำหนดของ กทช.

(This telecommunication equipments is in compliance with NTC requirements)

## United States (USA)

This device complies with Industry Canada's licence-exempt RSSs and part 15 of the FCC Rules. Operation is subject to the following two conditions:

(1) this device may not cause interference, and  
(2) this device must accept any interference, including interference that may cause undesired operation of the device.

Changes or modifications not expressly approved by the party responsible for compliance could void the user's authority to operate the equipment.

Le présent appareil est conforme aux CNR d'Industrie Canada applicables aux appareils radio exempts de licence. L'exploitation est autorisée aux deux conditions suivantes : (1) l'appareil ne doit pas produire de brouillage, et (2) l'appareil doit accepter tout brouillage radioélectrique subi, même si le brouillage est susceptible d'en compromettre le fonctionnement.

## Korea

적합성평가에 관한 고시

R-CMM-RBR-ICC651N

상호 : Robert Bosch Car Multimedia

GmbH 모델명 : ICC6.5in

기자재명칭 : 특정소출력 무선기기

(무선데이터통신시스템용 무선기기)

제조사 및 제조국가 : Robert Bosch Car  
Multimedia GmbH / 포르투갈

제조년월 : 제조년월로 표기

이 기기는 업무용 환경에서 사용할 목적으로 적합성평가를 받은 기기로서 가정용 환경에서 사용하는 경우 전파간섭의 우려가 있습니다.

-  
-Coding plug  
Installing, 77

**A**

Abbreviations and symbols, 6

**ABS**

Control, 19  
Displays, 49  
Operating, 67  
Self-diagnosis, 130  
Technology in detail, 144

**Accessories**

General notes, 190

**Air filter**

Position in motorcycle, 17  
Replacing insert, 177

**Ambient temperature**

Outside temperature  
warning, 38

**Anti-theft alarm system**

Indicator light, 22  
Operating, 83  
Technical Data, 223  
Warning indicator, 41

**ASC**

Control, 19  
Indicator and warning light , 50  
Operating, 69  
Self-diagnosis, 131  
Technology in detail, 147

**B****Battery**

Charging connected  
battery, 182  
Charging disconnected  
battery, 183  
Indicator light for vehicle  
voltage, 39, 40  
Installing, 184  
Maintenance instructions, 182  
Removing, 183  
Technical data, 222

**Bluetooth, 102**

Pairing, 102

**Brake fluid**

Checking fluid level at rear, 167  
Checking front fluid level, 166  
Front reservoir, 17  
Rear reservoir, 17

**Brake pads**

Check rear, 165  
Checking the front, 164  
Running in, 132

**Brakes**

ABS Pro in detail, 146  
ABS Pro dependent on riding  
mode, 136  
Adjust footbrake lever, 119  
Adjusting handlebar lever, 117  
Checking operation, 164  
Dynamic Brake Control  
depends on riding mode, 136  
Safety information, 135  
Technical Data, 219

**Breaking in, 132****Bulbs**

Replace additional LED  
headlight, 180  
Replace LED headlights, 180

Replacing tail light, 180  
Technical data, 223  
Turn indicators, 179  
Warning indicator for defective bulb, 40

## **C**

Care  
  Chrome, 203  
  Paint preservation, 204  
Case  
  Operating, 191  
Check Control  
  Dialog, 28  
  Display, 28  
Checklist, 128  
Clock  
  Adjusting, 101  
Clutch  
  Adjusting handlebar lever, 116  
  Checking operation, 168  
  Technical Data, 216

Coolant  
  Check fill level, 168  
  Indicator light for excess temperature, 43  
  Topping up, 169  
Cruise-control system  
  Operating, 78

## **D**

Damping  
  Rear adjuster, 15  
D-ESA  
  Control, 19  
  Operating, 70  
Diagnostic connector  
  fasten, 187  
  Loosen, 187  
Dimensions  
  Technical Data, 224  
DTC  
  Indicator and warning light , 50  
  Operating, 69  
  Self-diagnosis, 131  
  Technology in detail, 147  
Dynamic Brake Control, 152  
  Technology in detail, 152

## **E**

Electrical system  
  Technical Data, 222  
Emergency on/off switch (kill switch), 21  
  Operating, 64  
Engine  
  Indicator light for engine control, 44  
  Starting, 129  
  Technical Data, 215  
  Warning light for electronic engine management, 43  
Engine oil  
  Check fill level, 162  
  Electronic oil-level check, 42  
  Filling location, 17  
  Fluid level indicator, 17  
  Indicator light for engine oil level, 42  
  Technical Data, 215  
  Topping up, 163  
Equipment, 7

**F**

- Frame
  - Technical Data, 218
- Front wheel stand
  - Mounting, 161
- Fuel
  - Filling location, 15
  - Fuel specifications, 137
  - Refueling, 138
  - refueling with Keyless Ride, 139, 140
  - Technical Data, 214
- Fuel reserve
  - Range, 100
  - Warning indicator, 52
- Fuses
  - Replacing, 186

**G**

- Gearshift assistant
  - Gear not trained, 53
  - Riding, 134
  - Technology in detail, 155

**H**

- Handlebars
  - Adjusting, 122

- Hazard warning flashers
  - Control, 19, 21
  - Operating, 66
- Headlight
  - Headlamp range, 115
  - Headlight range adjustment, 15
- Headlight courtesy delay
  - feature, 58
- Heated handlebar grips
  - Control, 21
  - Operating, 86
- Hill Start Control, 80, 156
  - cannot be activated, 53
  - Indicator and warning lights, 53
  - Operating, 81
  - Technology in detail, 156
  - Turn on and off, 81
- Hill Start Control Pro
  - Adjusting, 83
  - Operating, 82
  - Technology in detail, 156
- Horn, 19

**I**

- Ignition
  - Switching off, 59
  - Switching on, 58
- Immobilizer
  - Emergency key, 62
  - Spare key, 59
- Indicator lights, 22
  - Overview, 24
- Instrument cluster
  - Ambient light photosensor, 22
  - Overview, 22

**J**

- Jump-start, 180

**K**

- Keyless Ride
  - Battery of radio-operated key is completely drained or radio-operated key has been lost, 62
  - EWS Electronic immobilizer, 62
  - Locking handlebars, 60
  - Switch off ignition, 61
  - Switching on ignition, 61



Unlocking fuel filler cap, 139, 140  
Warning indicator, 38, 39  
Keys, 58, 60

## L

Lights  
Control, 19  
Low beams, 64  
Operating headlight flasher, 64  
Operating high-beam headlight, 64  
Operating the auxiliary headlight, 65  
Parking lights, 64, 65  
Lowered suspension  
Limitations, 126  
Luggage  
Loading information, 126

## M

Maintenance  
Maintenance schedule, 233  
Maintenance confirmations, 234  
Maintenance intervals, 230

Media  
Operating, 110  
Menu  
Calling up, 96  
Mirrors  
Adjusting, 114  
Adjusting mirror arm, 115  
Adjusting mirrors, 114  
Mobility Services, 230  
Motorcycle  
Care, 201  
Cleaning, 201  
Lashing, 141  
Parking, 137  
Returning to use, 205  
Storage, 205  
Multifunction switch  
General view, left, 19  
Overall view, right, 21

## N

Navigation  
Operating, 108  
Notice concerning current status, 8

## O

Offroad riding, 133  
Onboard computer, 105  
Onboard power socket  
Information on use, 190  
Position on motorcycle, 17  
Onboard tool kit  
Position on motorcycle, 18  
Operating focus  
change, 97  
Outside temperature  
Display, 38  
Overview of warning indicators, 31  
Overviews  
Indicator and warning lights, 24  
Instrument cluster, 22  
Left side of vehicle, 15  
Left-side multifunction switch, 19  
My vehicle, 105  
My Vehicle, 105  
Right side of vehicle, 17  
Right-hand multifunction switch, 21

- TFT display, 25, 27
- Underneath seat, 18
- P**
- Pairing, 102
- Parking light, 65
- Performance data
  - Technical data, 226
- Phone
  - Operating, 110
- Pre-Ride-Check, 130
- Pure Ride
  - Overview, 25
- R**
- RDC
  - Rim sticker, 171
  - Technology in detail, 153
  - Warning lights, 45
- Rear-wheel drive
  - Technical Data, 217
- Refueling, 138
  - Fuel specifications, 137
  - with Keyless Ride, 139, 140
- Remote control
  - Replacing the battery, 63
- Rider info status line
  - Adjusting, 98, 99
- Rider's Manual (US Model)
  - Position on motorcycle, 18
- Riding mode
  - Adjusting, 74
  - Control, 21
  - Setting the PRO riding mode, 76
  - Technology in detail, 150
- Road sign detection
  - switch on or off, 99
- S**
- Safety instructions
  - On braking, 135
  - On riding, 126
- Seat
  - Height adjustment position, 18
- Seats
  - Adjusting the seat height, 88
  - Locking mechanism, 15
  - Removing and installing, 87
- Service, 229
  - Electronic Service Manual, 229
  - Reporting safety defects, 228
- Service display, 54
- Shift lever
  - Adjusting, 120
- ShiftCam, 157
  - Technology in detail, 157
- Shifting gears
  - Upshift recommendation, 100
- Spark plugs
  - Technical Data, 222
- Speedometer, 22
- Spring preload
  - Adjusting, 123
  - Rear adjuster, 17
- Starting, 129
  - Control, 21
- Steering lock
  - Locking, 58
- Suspension
  - Technical Data, 218
- Switching off, 137

## T

- Tachometer, 22
  - Tachometer, 99
- Technical data
  - Anti-theft alarm system, 223
  - Battery, 222
  - Brakes, 219
  - Bulbs, 223
  - Clutch, 216
  - Dimensions, 224
  - Electrical system, 222
  - Engine, 215
  - Engine oil, 215
  - Frame, 218
  - Fuel, 214
  - General notes, 7
  - Performance data, 226
  - Rear-wheel drive, 217
  - Spark plugs, 222
  - Standards, 7
  - Suspension, 218
  - Transmission, 216
  - Weights, 226
  - Wheels and tires, 220
- TFT display, 22
  - Control, 19
  - Operating, 96, 97, 98
  - Overview, 25, 27
  - Selecting display readings, 93
- Threaded fasteners, 211
- Tire Pressure Control TPC/RDC
  - Display, 44
- Tires
  - Checking tire inflation pressures, 169
  - Checking tire tread depth, 170
  - Inflation pressure table, 15
  - Inflation pressures, 221
  - Maximum speed, 127
  - Running in, 133
  - Technical Data, 220
- Topcase
  - Operating, 193
- Torques, 211
- Traction Control
  - ASC, 147
  - DTC, 147

- Transmission
  - Technical Data, 216
- Troubleshooting chart, 208
- Turn indicators
  - Control, 19
  - Control, right, 21
  - Operating, 66
- Type plate
  - Position on motorcycle, 17

## V

- Values
  - Display, 28
- Vehicle identification number
  - Position on motorcycle, 17
- Vehicle voltage
  - Warning indicator, 39, 40

## W

- Warning lamps, 22
  - ABS, 49
  - Anti-theft alarm system, 41
  - ASC, 50
  - Coolant temperature, 43
  - Display, 28
  - DTC, 50

- Electronic engine management, 43
- Engine management system, 44
- Engine oil level, 42
- Fuel reserve, 52
- Gear not trained, 53
- Hill Start Control, 53
- Light source defect, 40
- My vehicle, 105
- My Vehicle, 105
- Outside temperature warning, 38
- Overview, 24
- TPM Tire Pressure Monitor, 45
- Vehicle voltage, 39, 40
- Weights
  - Load capacity table, 18
  - Technical Data, 226
- Wheels
  - Check wheel rims, 170
  - Checking spokes, 170
  - Checking wheel rims, 170
  - Installing rear wheel, 177
  - Installing the front wheel, 173
  - Removing front wheel, 171
  - Size change, 171
  - Technical Data, 220
- Windshield
  - Adjusting, 116
  - Adjusting element, 17



The descriptions and illustrations in this manual may vary from your own motorcycle's actual equipment, depending upon its equipment level and accessories as well as your specific national version. No claims stemming from these differences can be recognized.

Dimensions, weights, fuel consumption and performance data are quoted to the customary tolerances.

The right to modify designs, equipment and accessories is reserved.

Errors and omissions excepted.

© 2019 Bayerische Motoren Werke Aktiengesellschaft  
80788 Munich, Germany  
Reprints and duplication of this work, in whole or part, are prohibited without the express written approval of BMW Motorrad, Aftersales.

Original Rider's Manual, printed in Germany.

## **WARNING**

### **Harmful substances**

Operating, servicing and maintaining a passenger vehicle or off-road vehicle can expose you to chemicals including engine exhaust, carbon monoxide, phthalates and lead, which are known to the State of California to be carcinogenic or detrimental to childbirth or reproduction.

- To minimize exposure, avoid breathing exhaust, do not idle the engine except as necessary, service your vehicle in a well-ventilated area and wear gloves or wash your hands frequently when servicing your vehicle.
- For more information visit: [www.P65Warnings.ca.gov/passenger-vehicle](http://www.P65Warnings.ca.gov/passenger-vehicle) ◀

