



**EVOTECH**®  
P E R F O R M A N C E

**Suzuki GSXR1000**

**Oil Cooler Guard**

**Installation Instructions**



**Product No: PRN013586**

**Kit Contents**

- A** 1 x Oil Cooler Guard
- B** 2 x Rubber Bungs



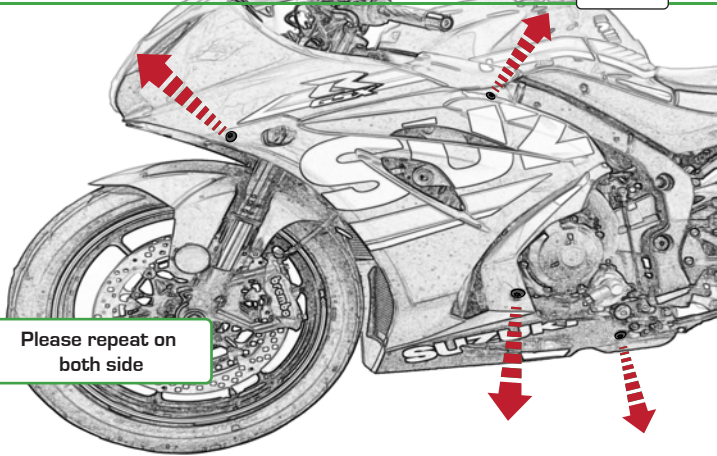

Please repeat on both side

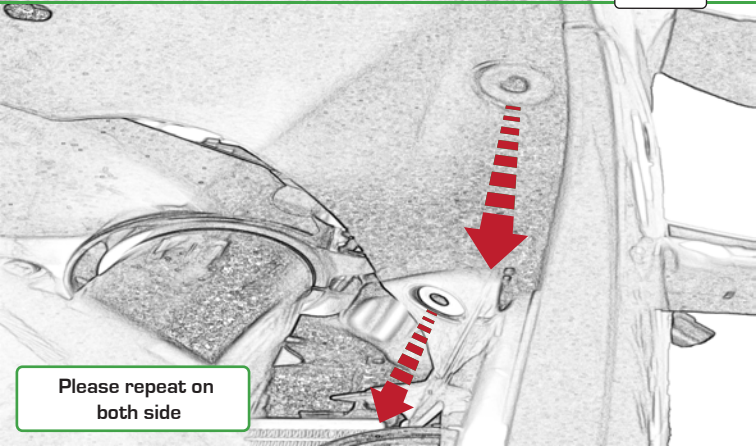

Please repeat on  
both side

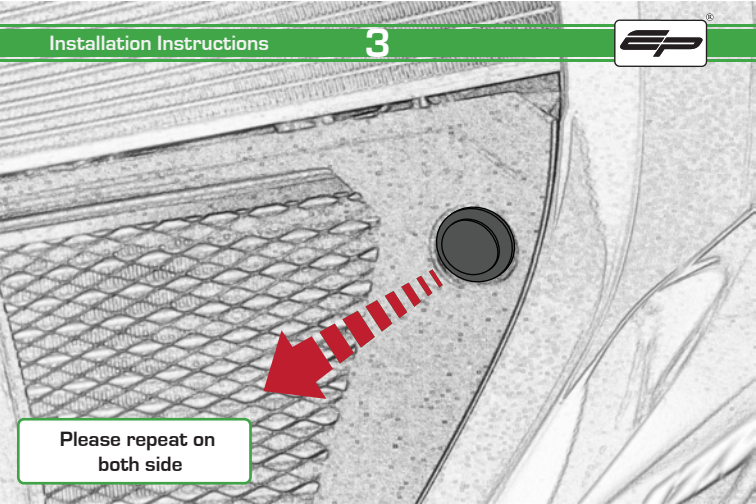

Please repeat on  
both side

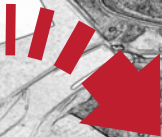

**Pull fairing back and out to release from rubber bung location**

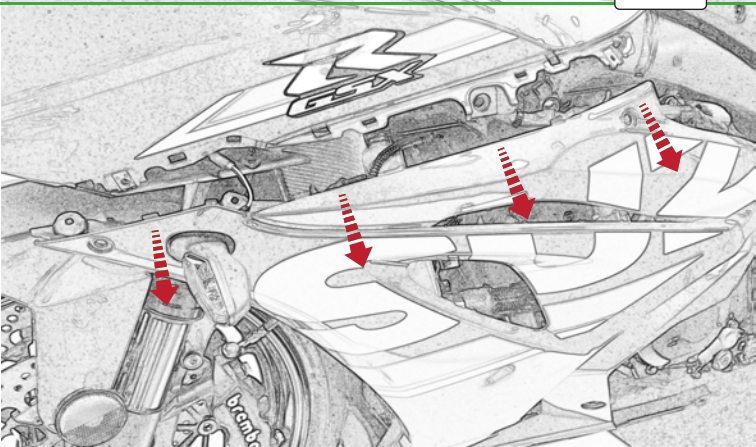

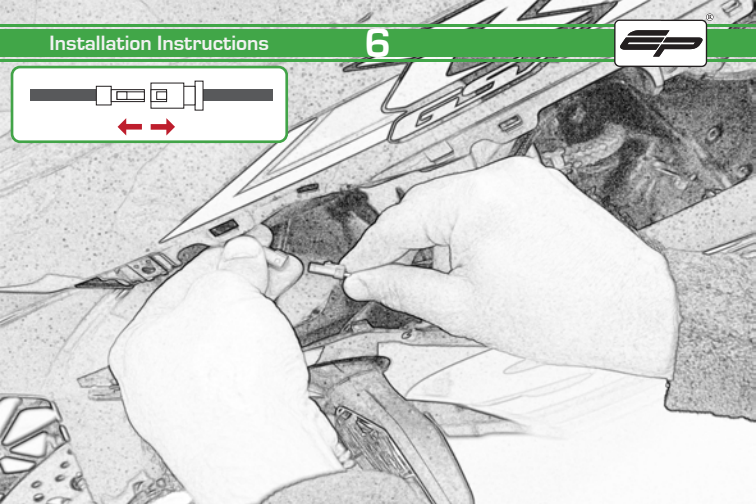
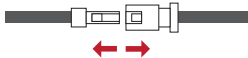



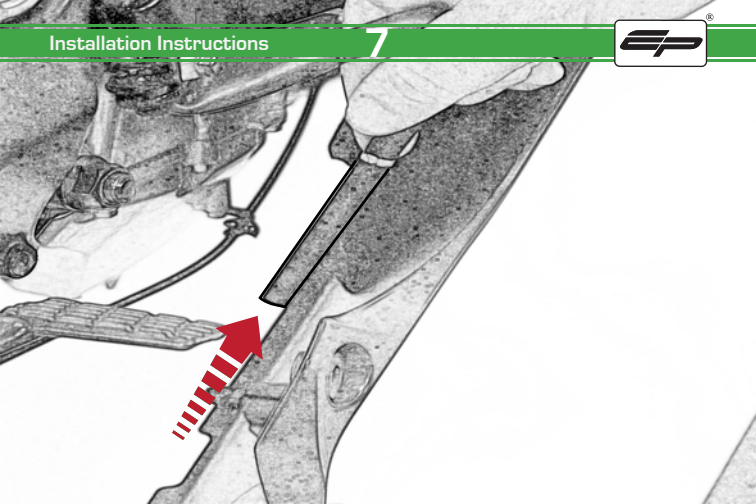

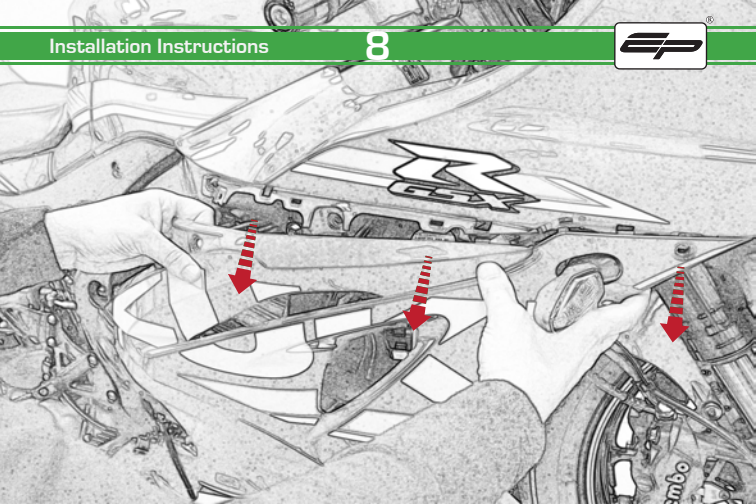

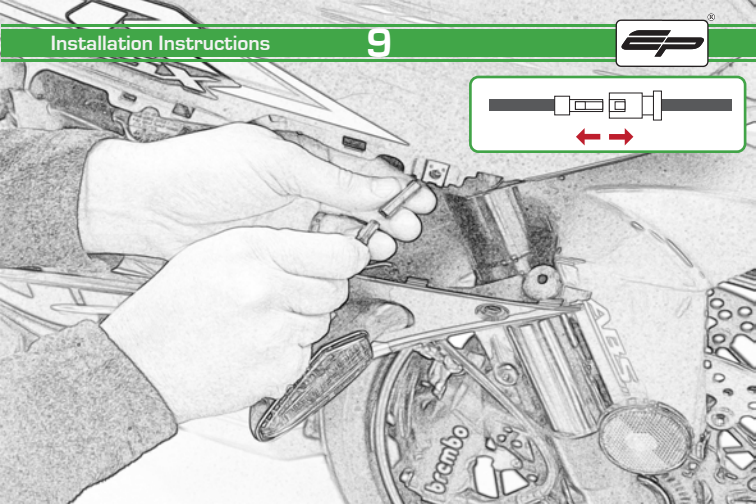
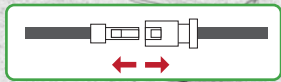



Caution

Lay a towel or cloth on the ground to stop damaging the fairing

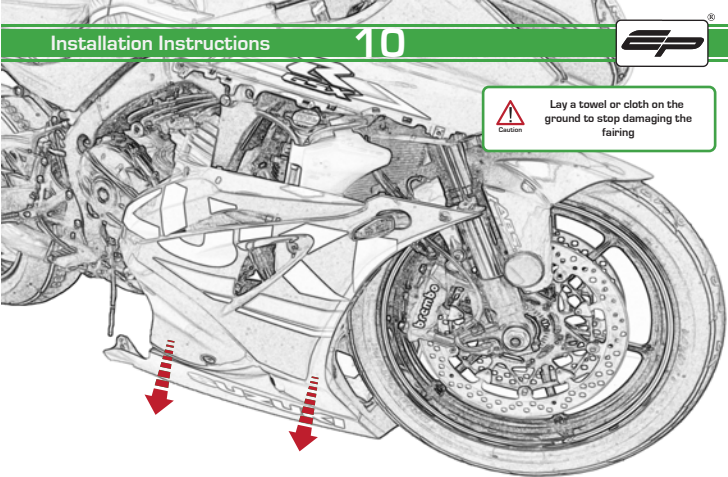



Caution

Remove fairing by rotating  
the complete panel underneath  
the bike

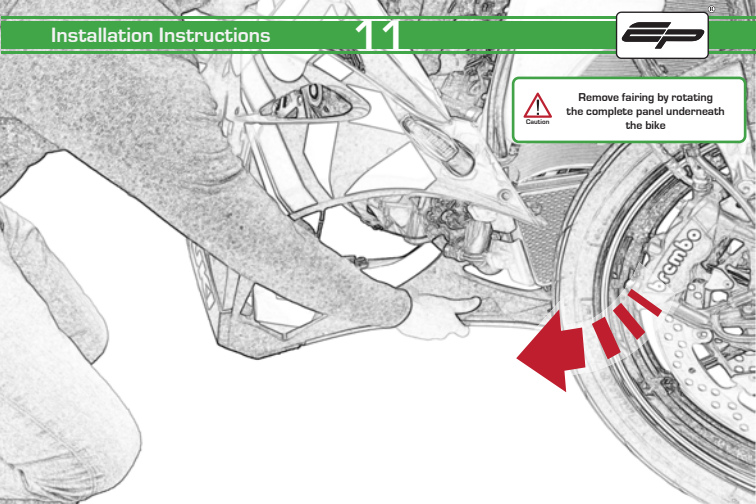

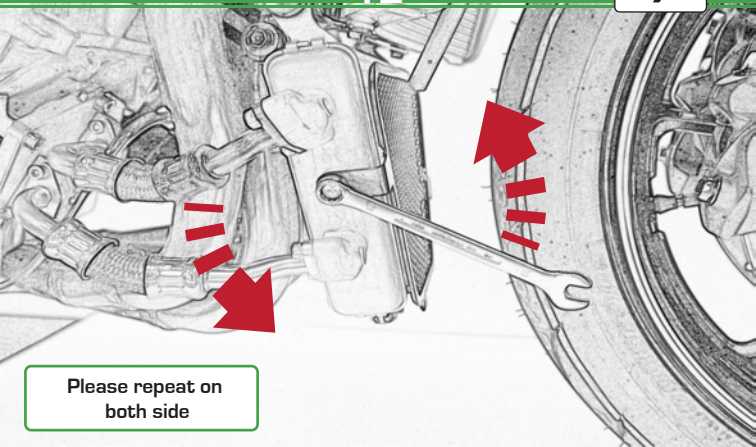

Please repeat on  
both side

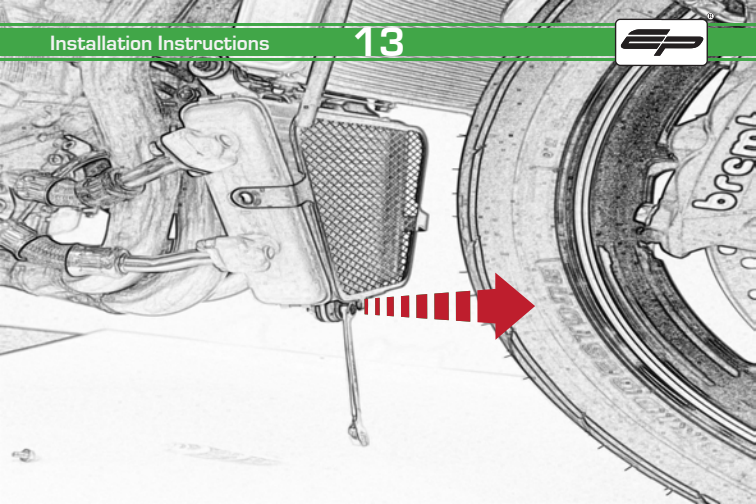

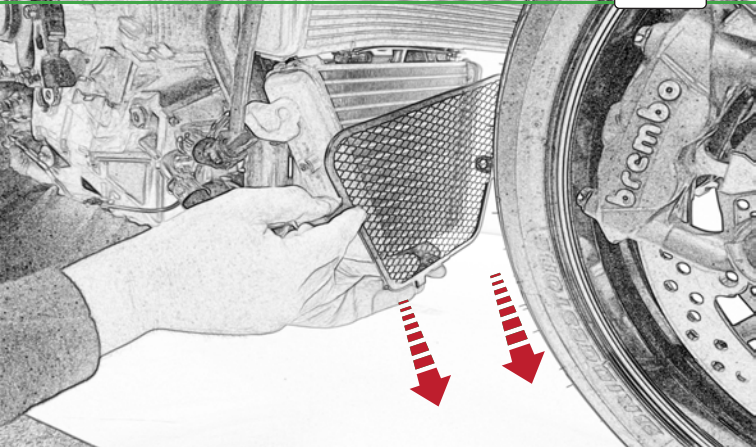



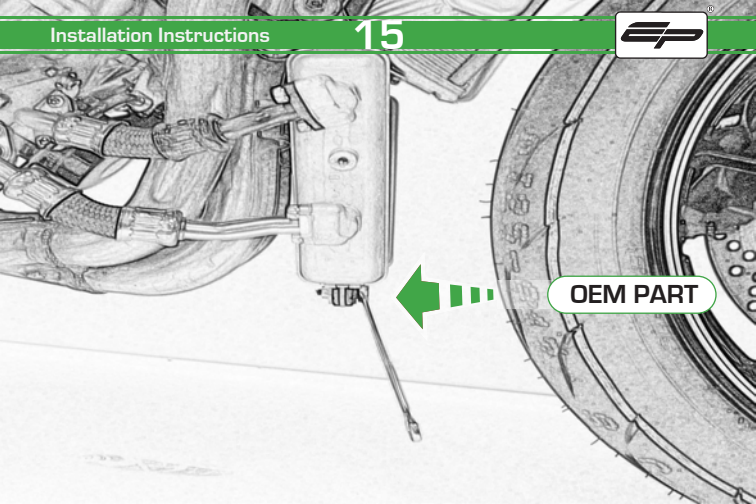

OEM PART

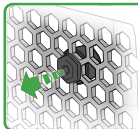

Locate round holes  
amongst hexagons.

Push Rubber Spacer  
through from the  
front of the guard  
so Hexagonal shape  
sits on the back face

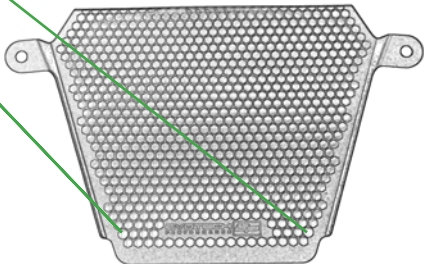



Install fairing by rotating  
the complete panel underneath  
the bike

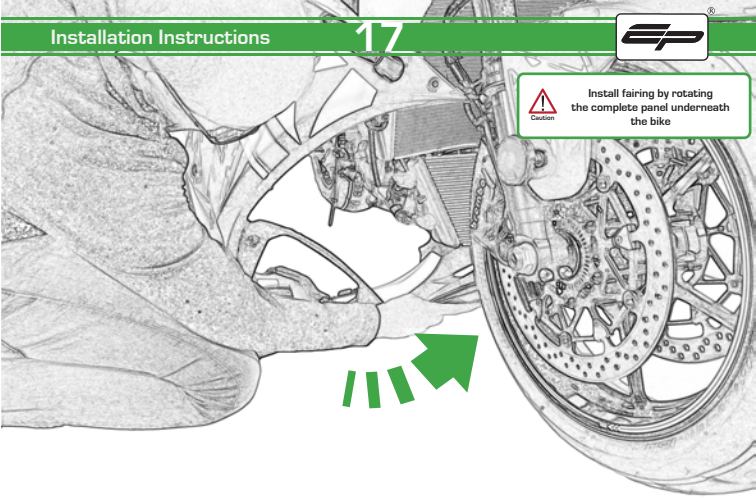

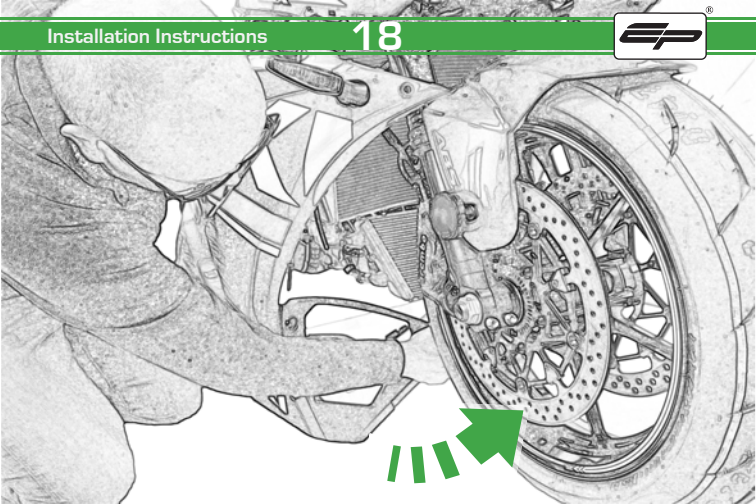

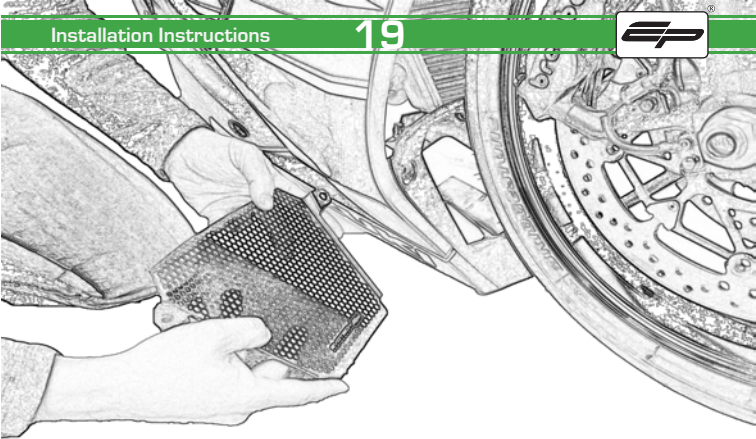

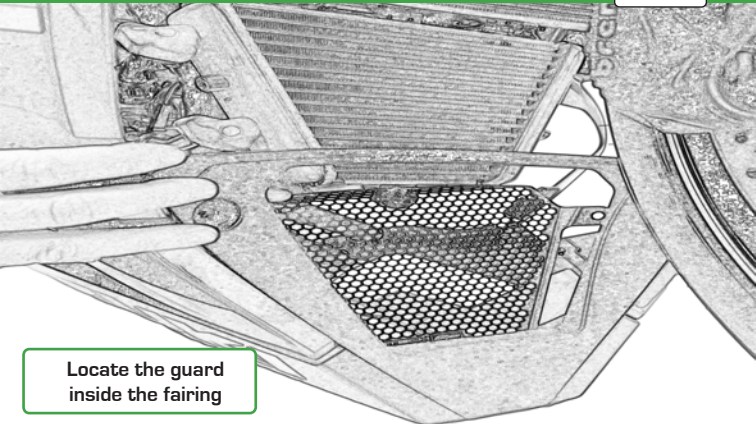

**Locate the guard  
inside the fairing**

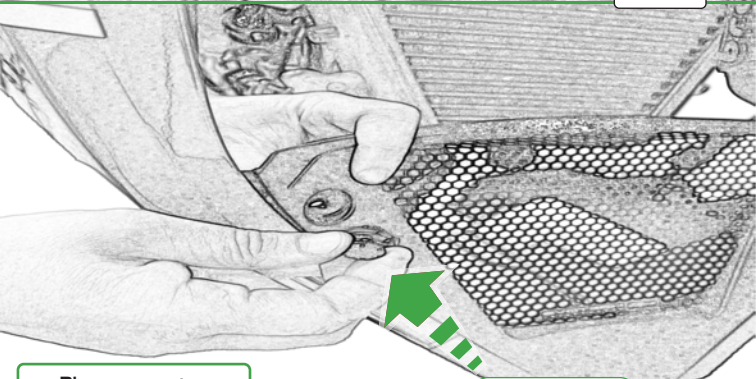

Please repeat on  
both side

OEM PART



Reverse Stages

9 - 1



## ESSENTIAL CHECKS

It is recommended that periodic inspections are made to ensure that dirt and debris have not become trapped between the guard and the radiator/oil cooler. Such dirt and debris would reduce the cooling efficiency of the radiator/oil cooler.

It is recommended that periodic inspections are made to ensure that all fixings are fully tightened.