

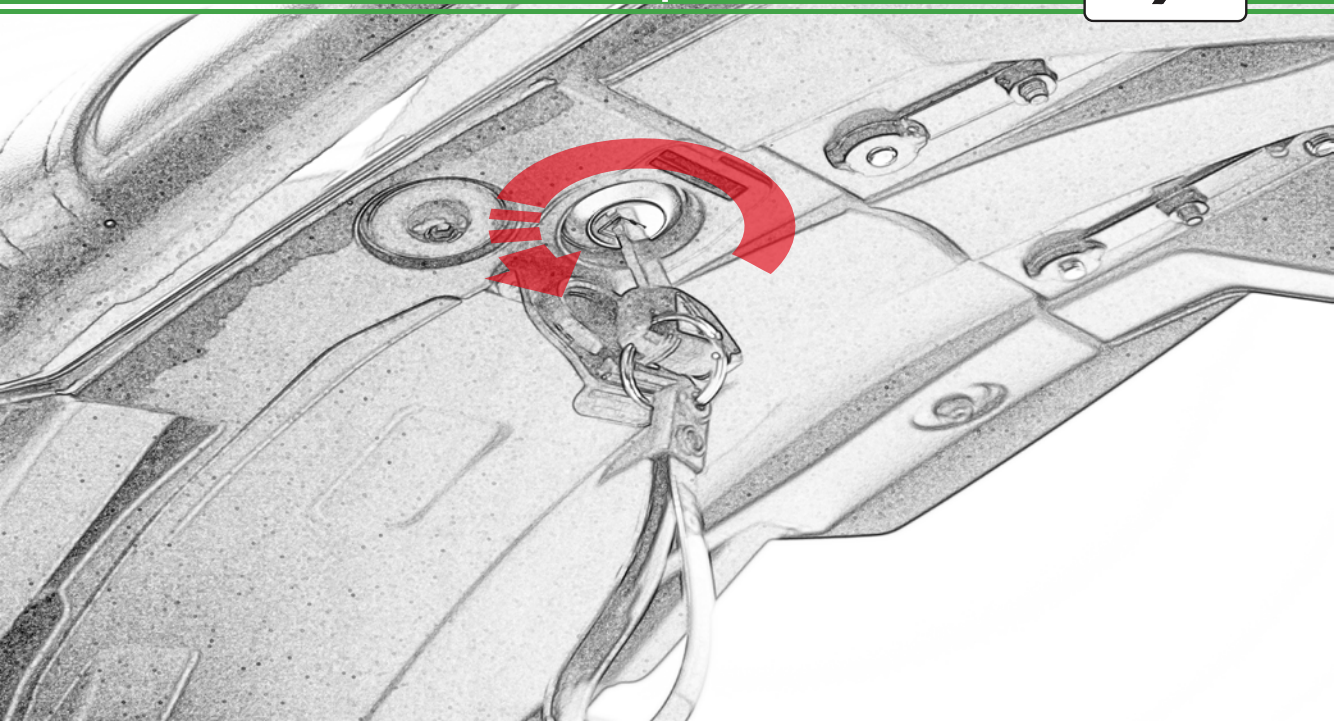

Kit Contents PRN015749

- (A) 1 x Cable Tie
- (B) 1 x Rubber Pad
- (C) 1 x Retro Light
- (D) 1 x Connector No.5
- (E) 1 x Light Block
- (F) 2 x M4 x 10 Button Head Bolts
- (G) 2 x M6 x 20 Button Head Bolts
- (H) 2 x M6 x 25 Button Head Bolts
- (I) 2 x M4 Flange Nut
- (J) 4 x M6 Flange Nut

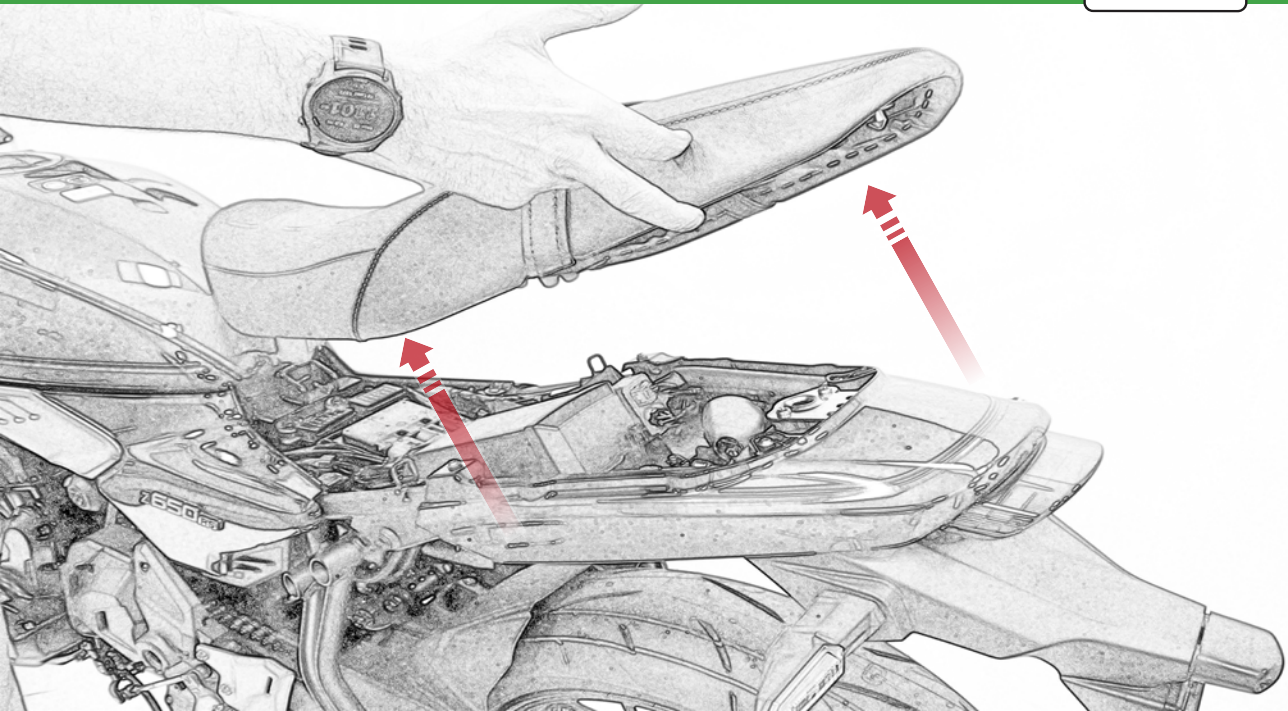



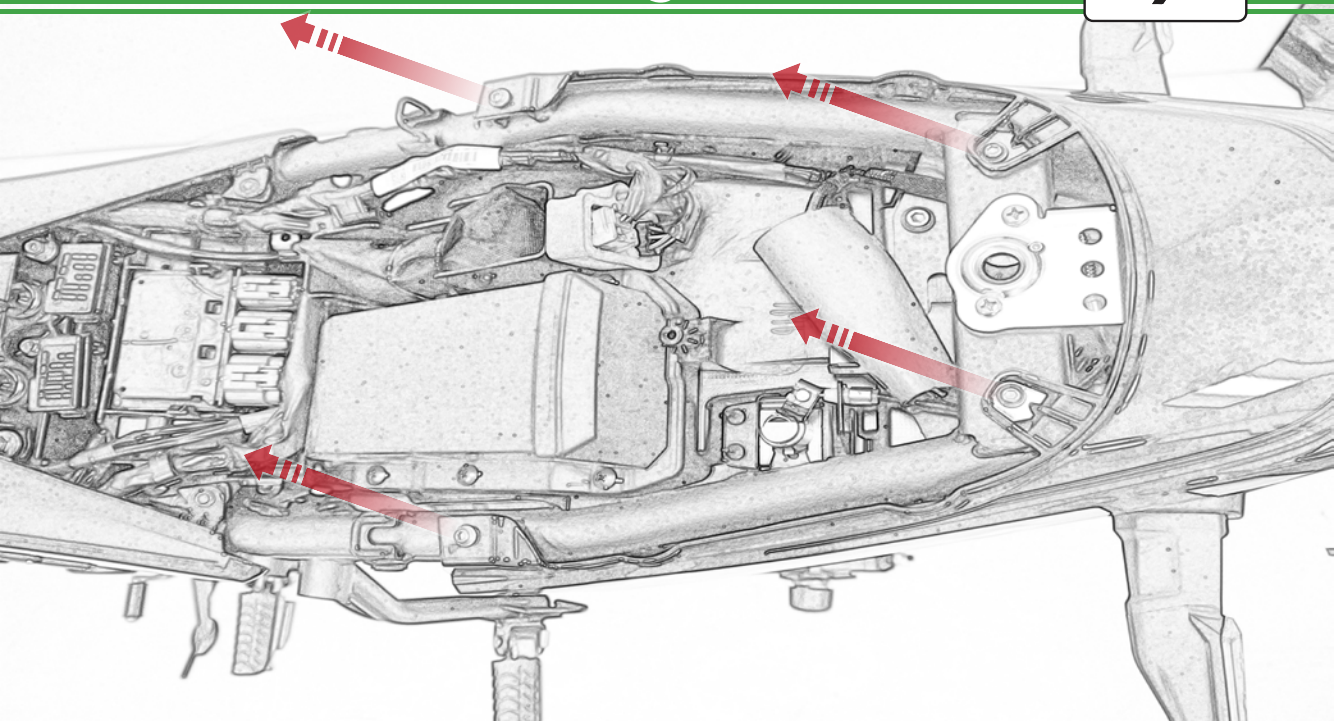

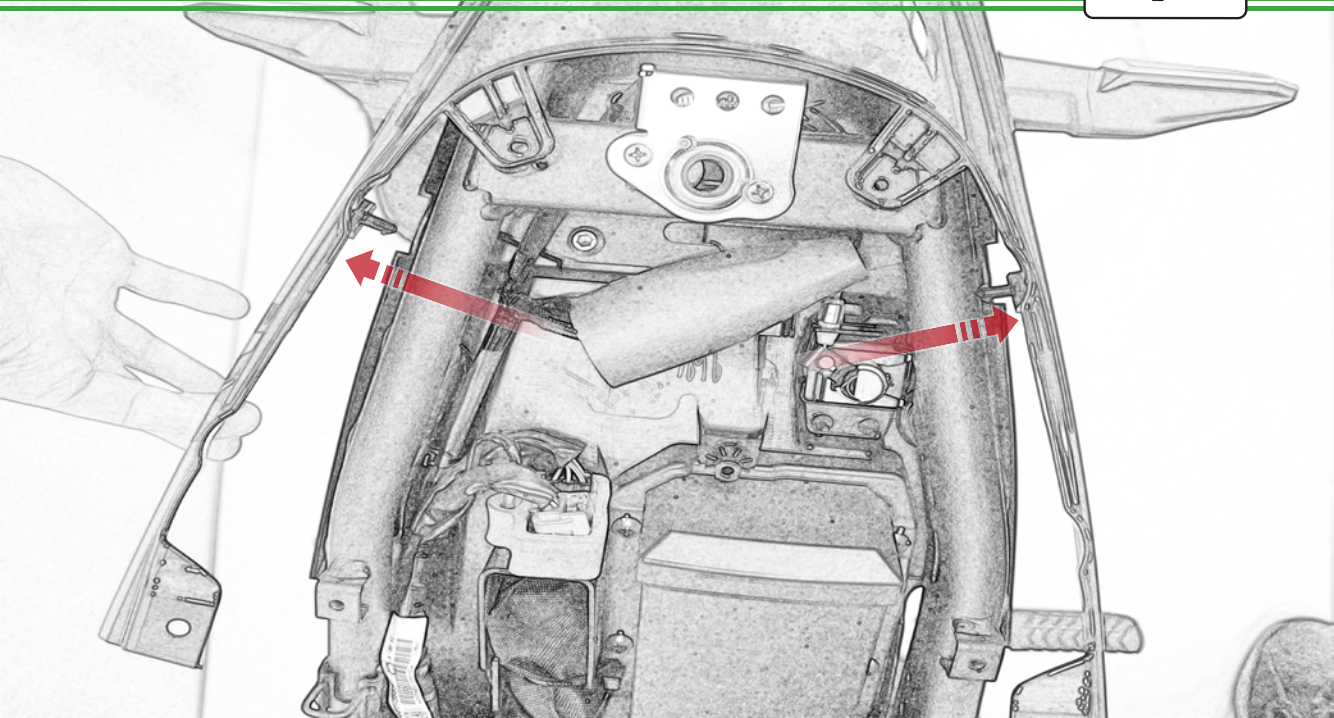

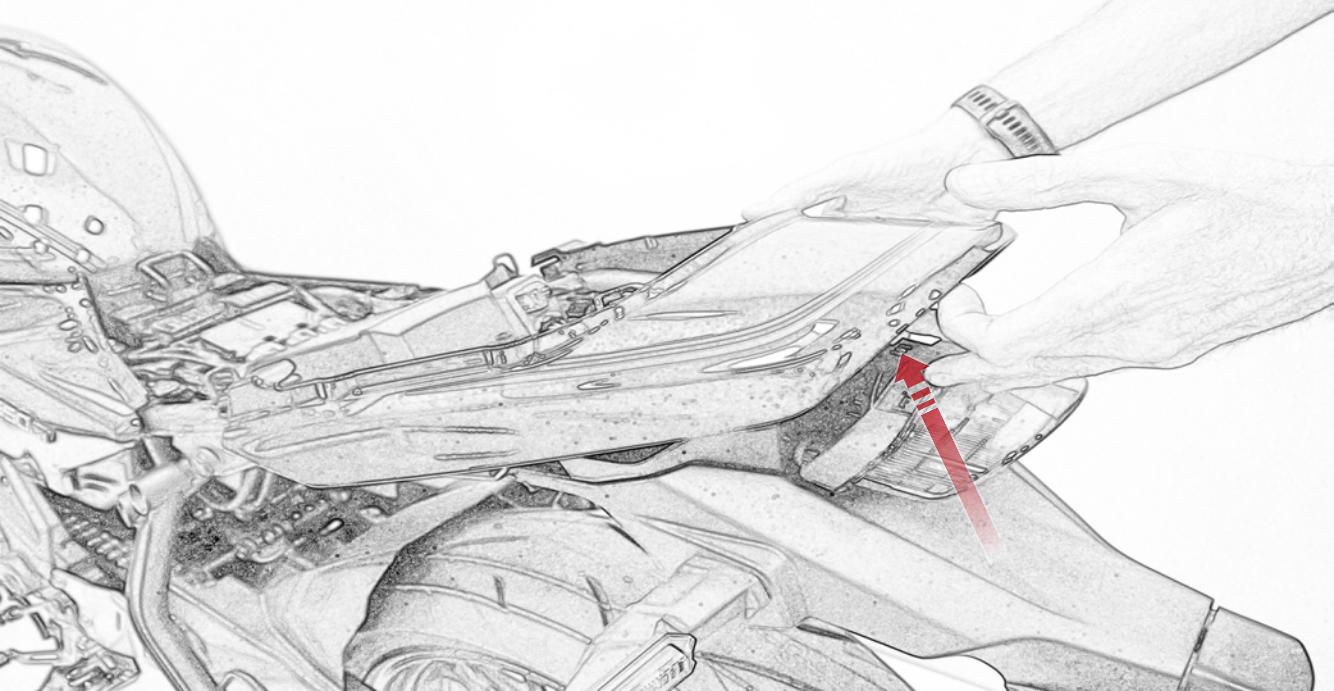

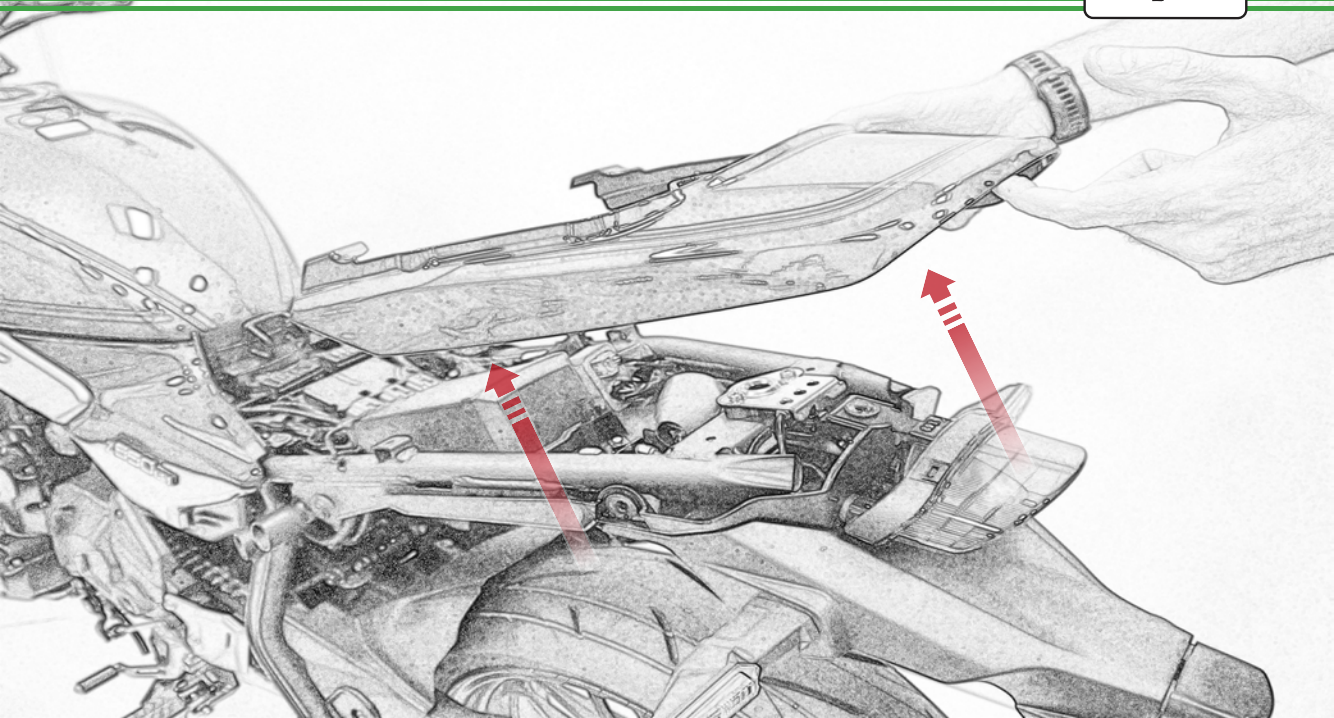

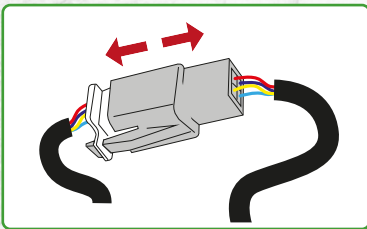
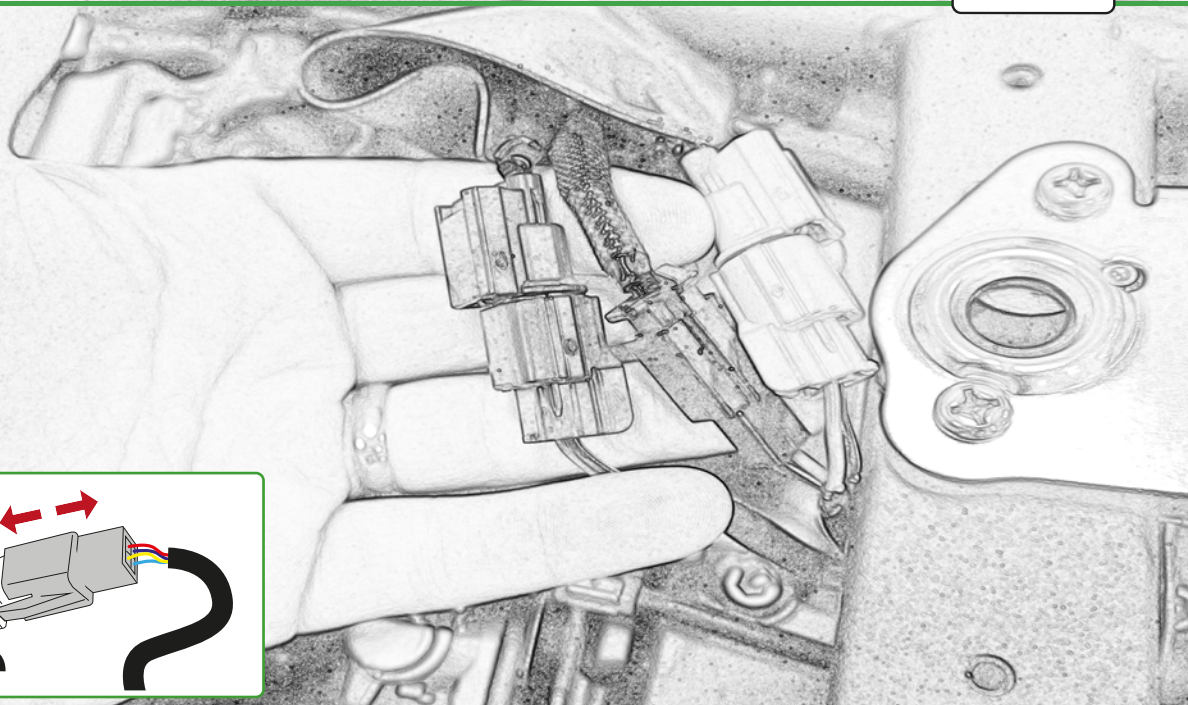

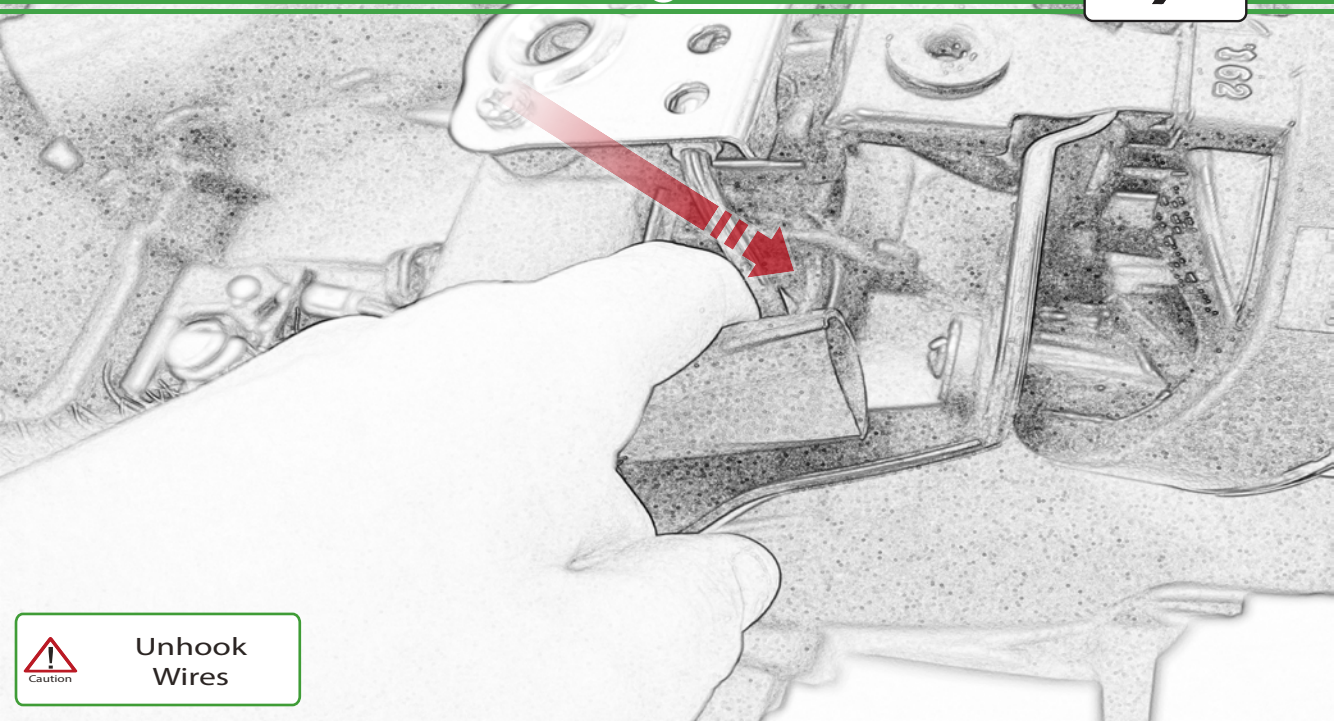

Unhook
Wires

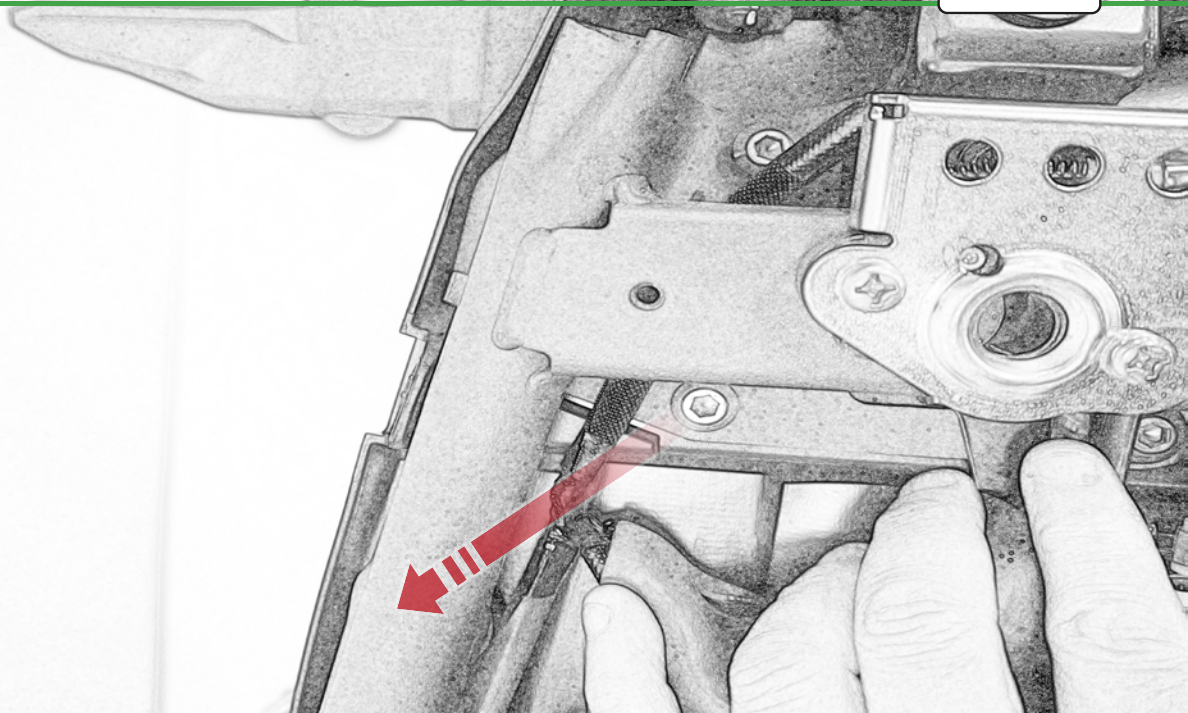

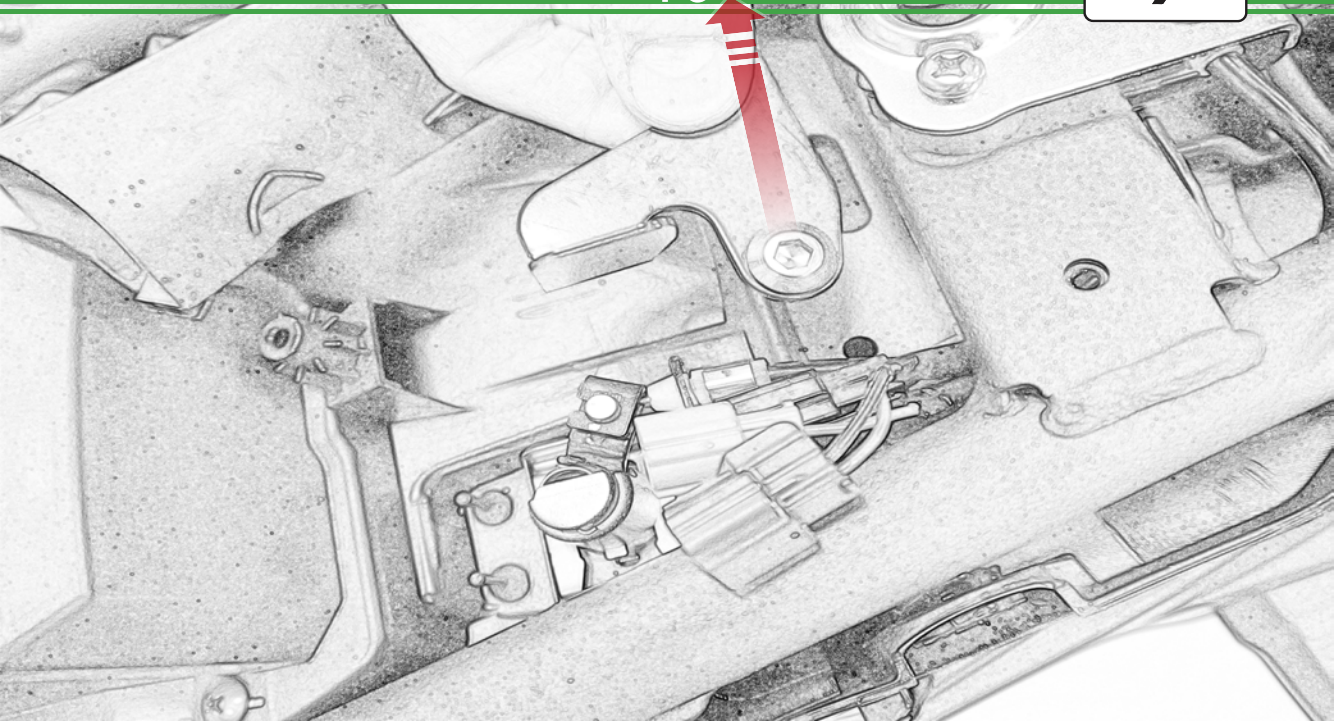

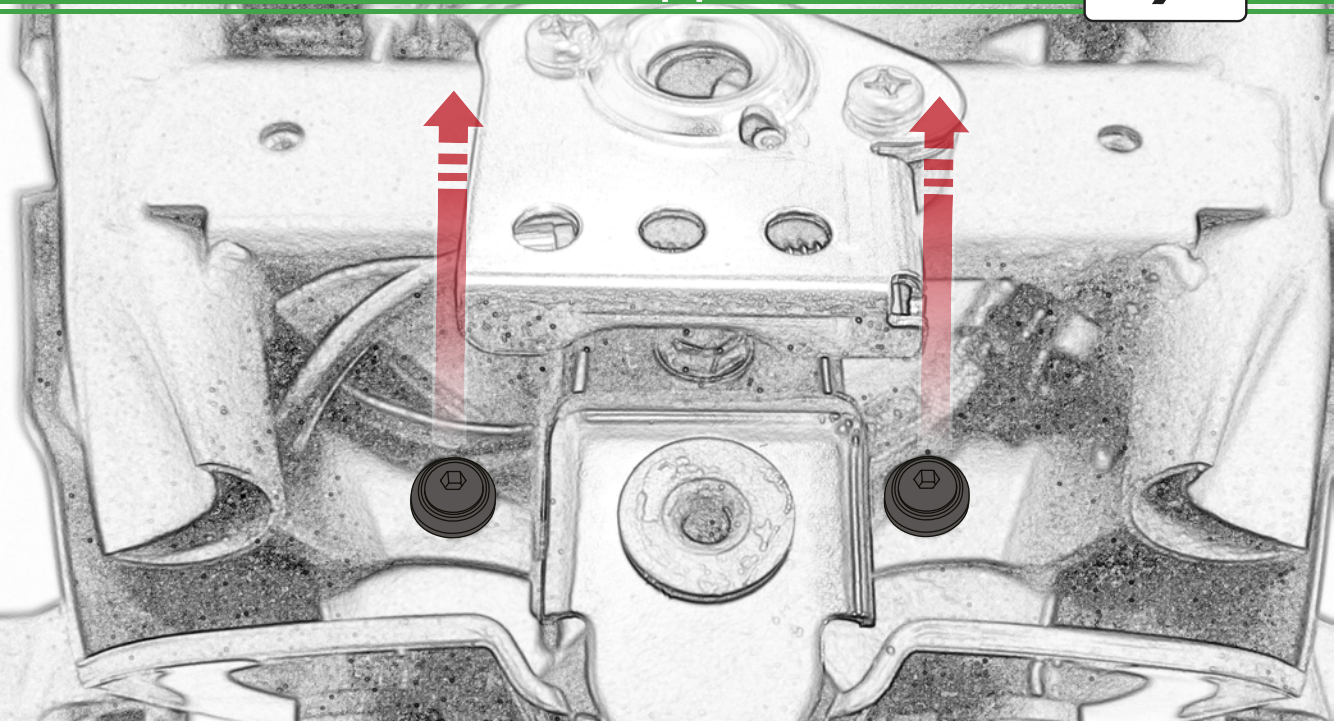

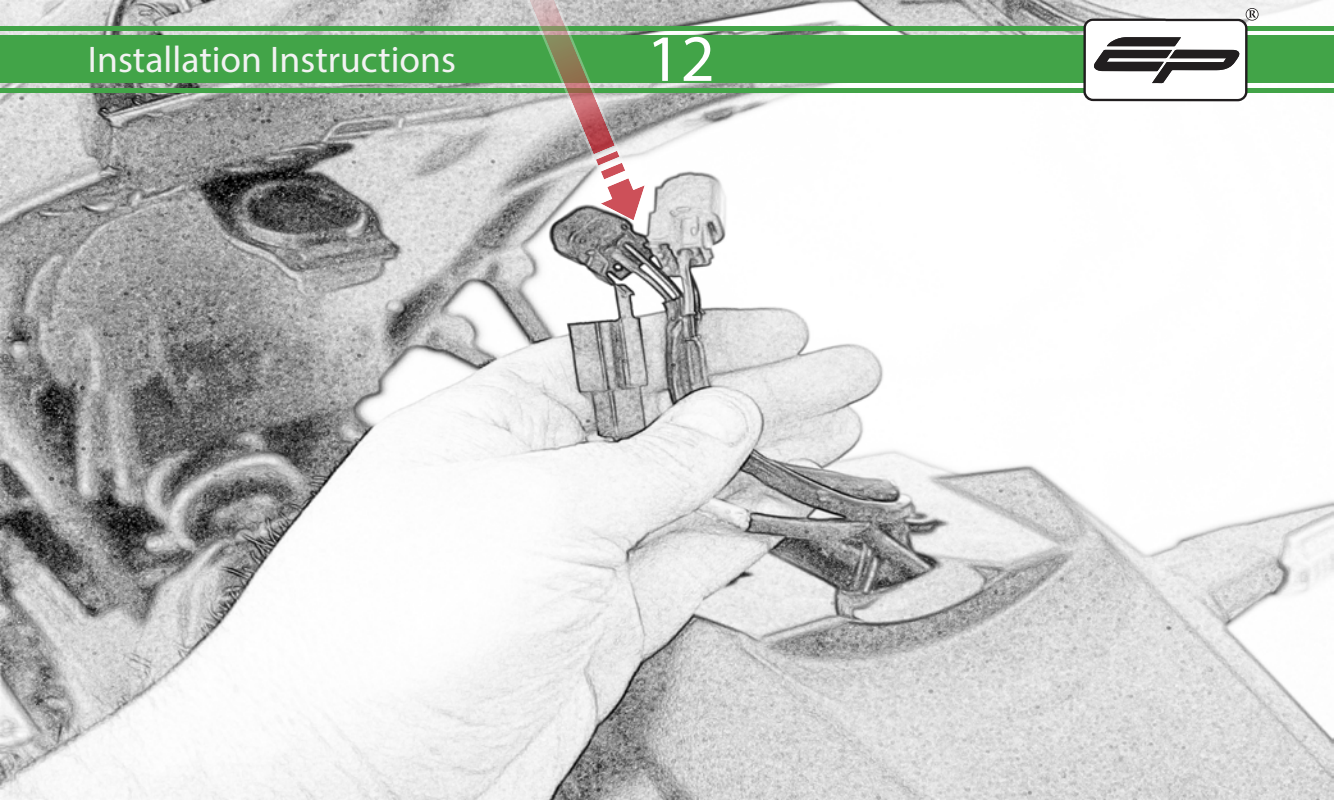

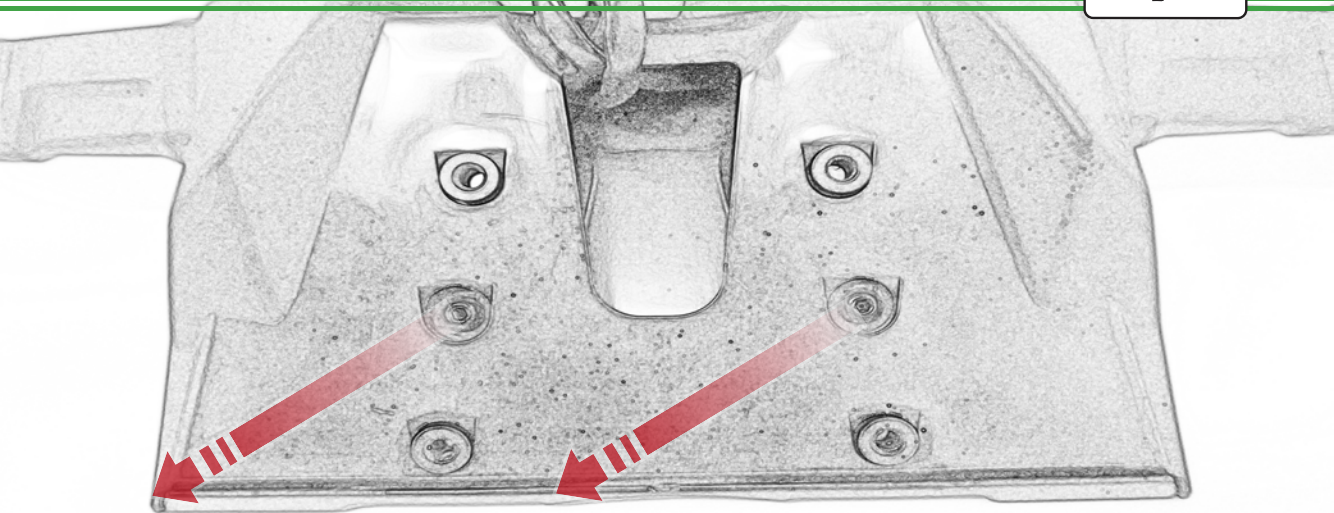

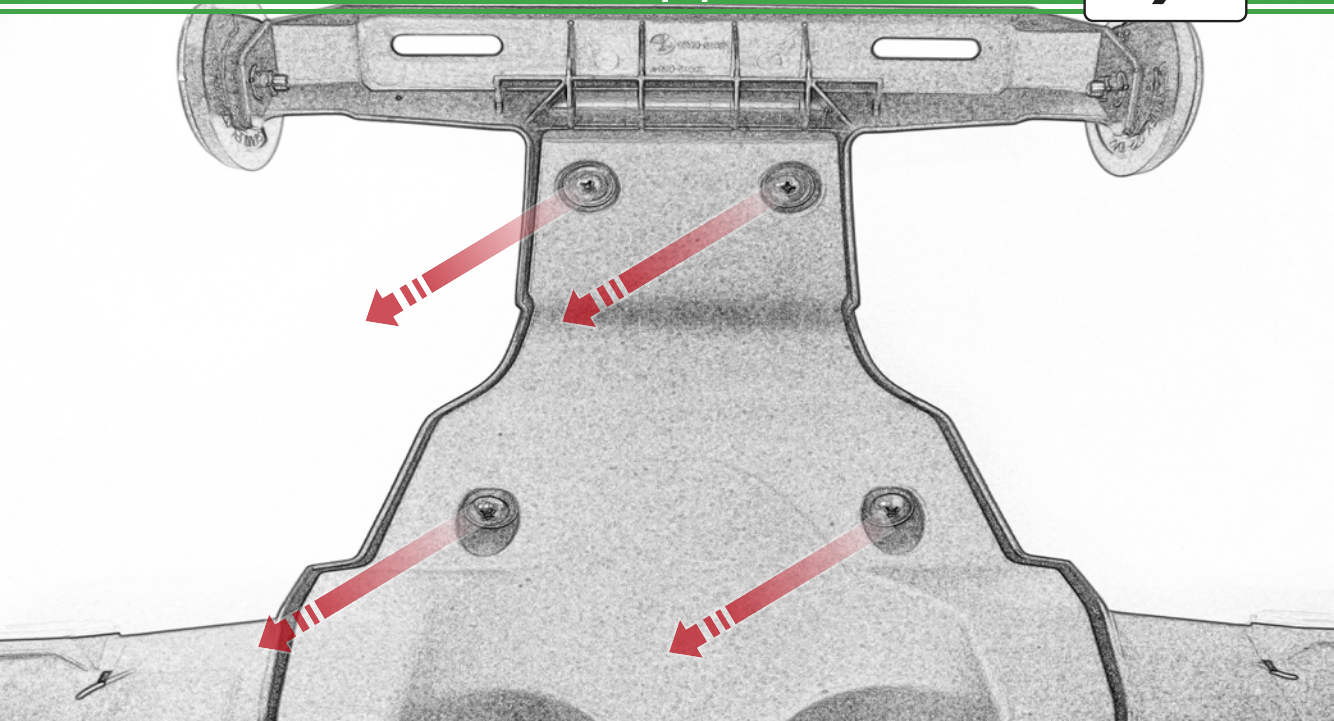

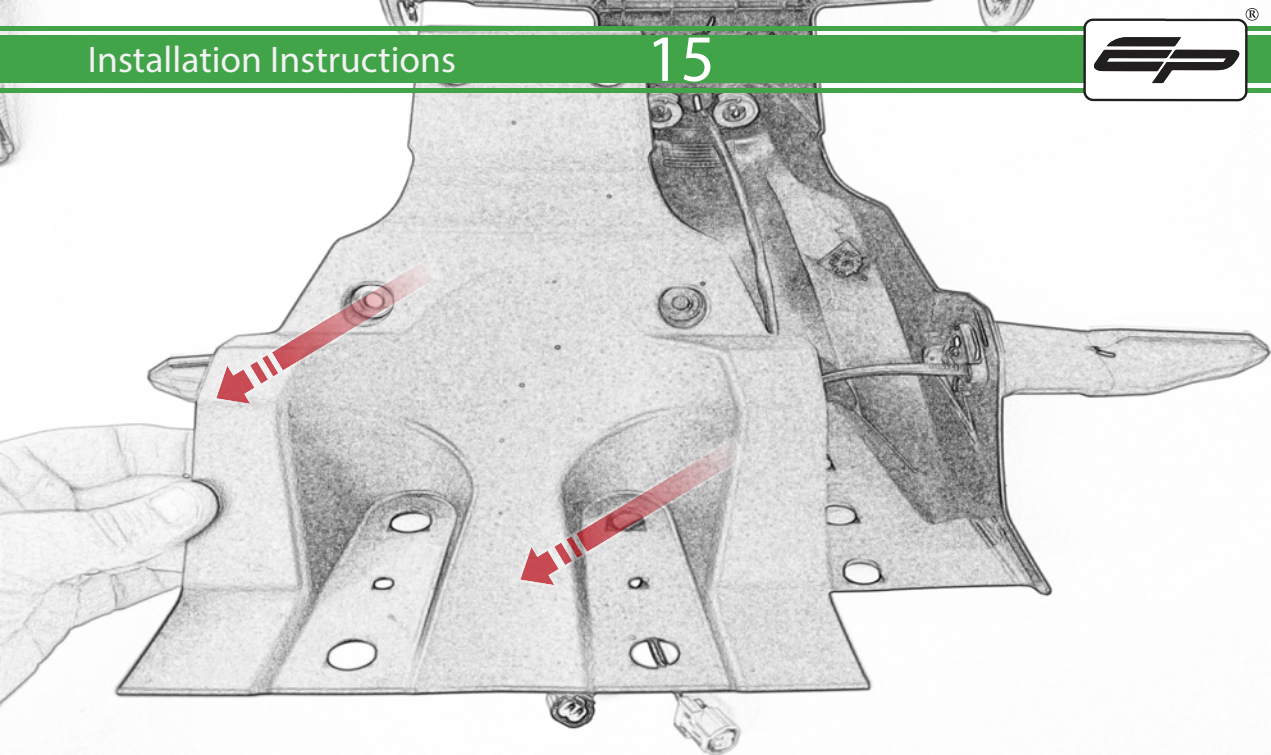

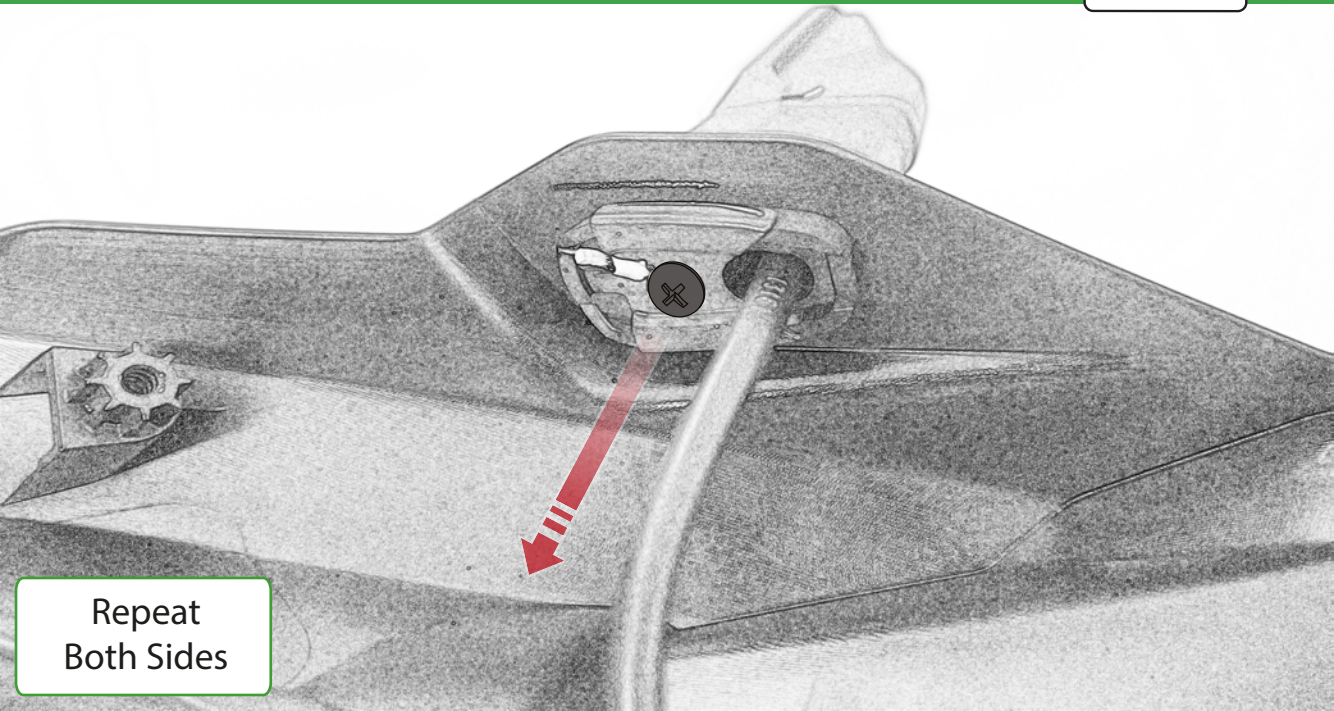

Repeat
Both Sides

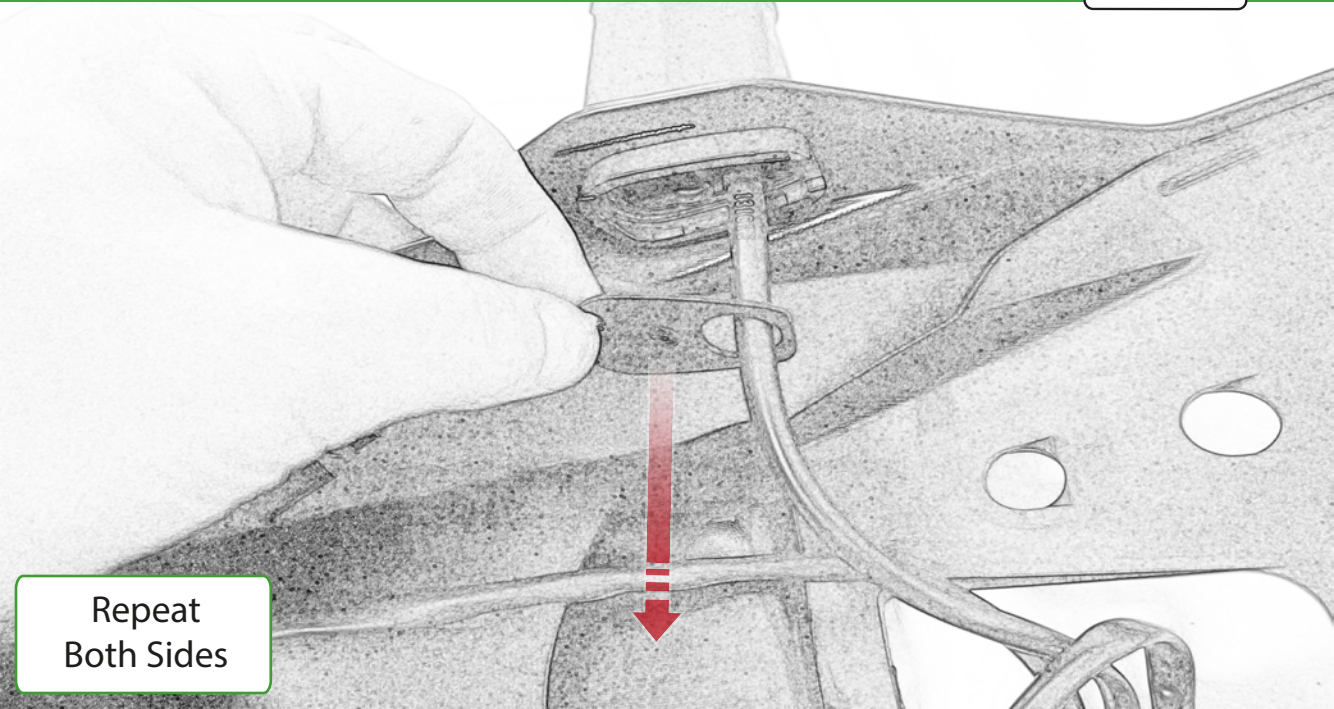

Repeat
Both Sides

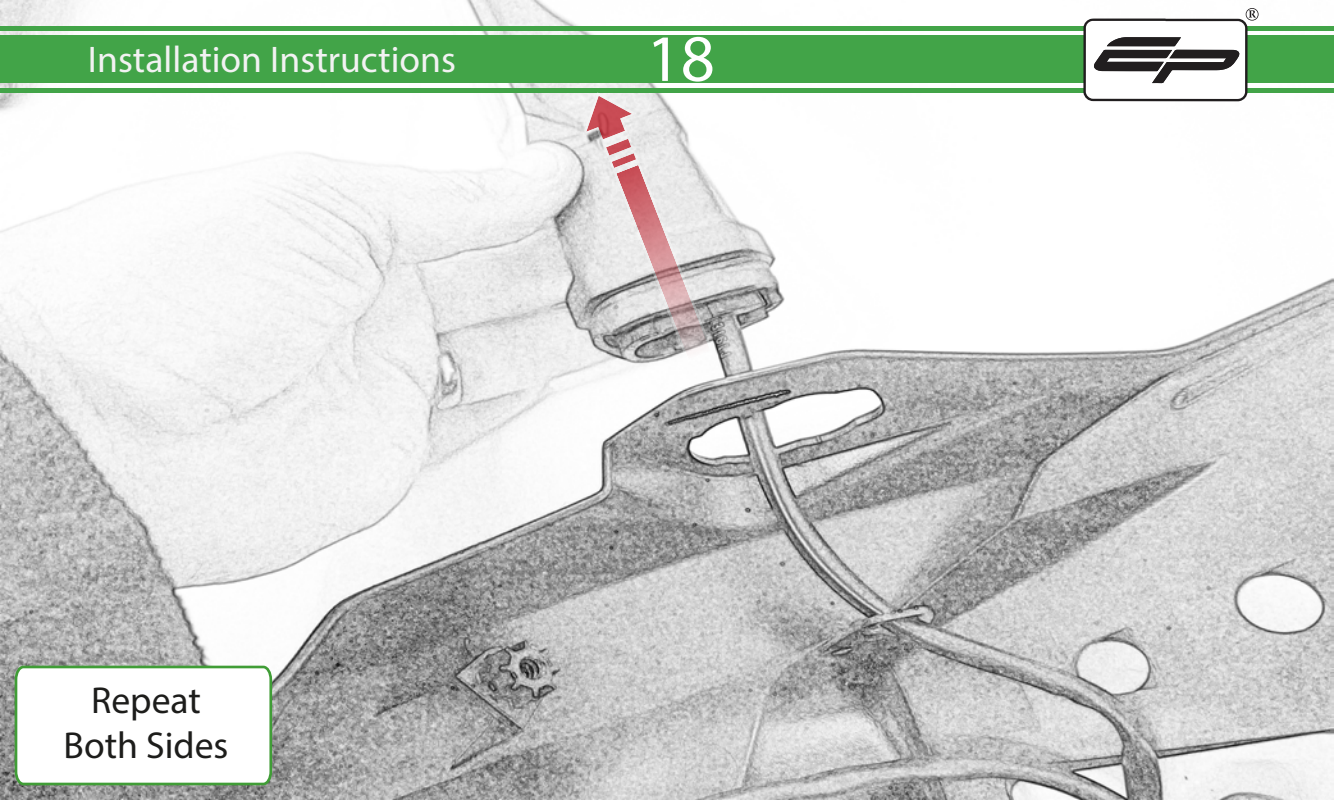

Repeat
Both Sides

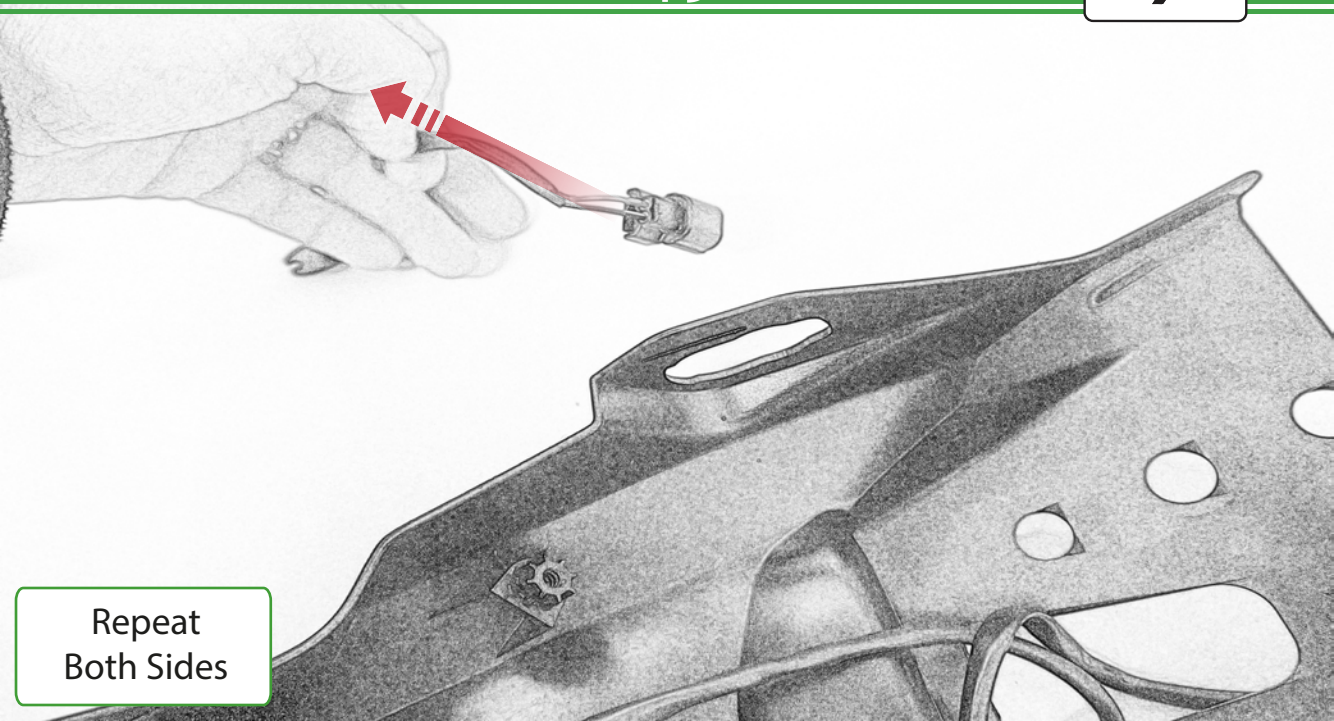

Repeat
Both Sides

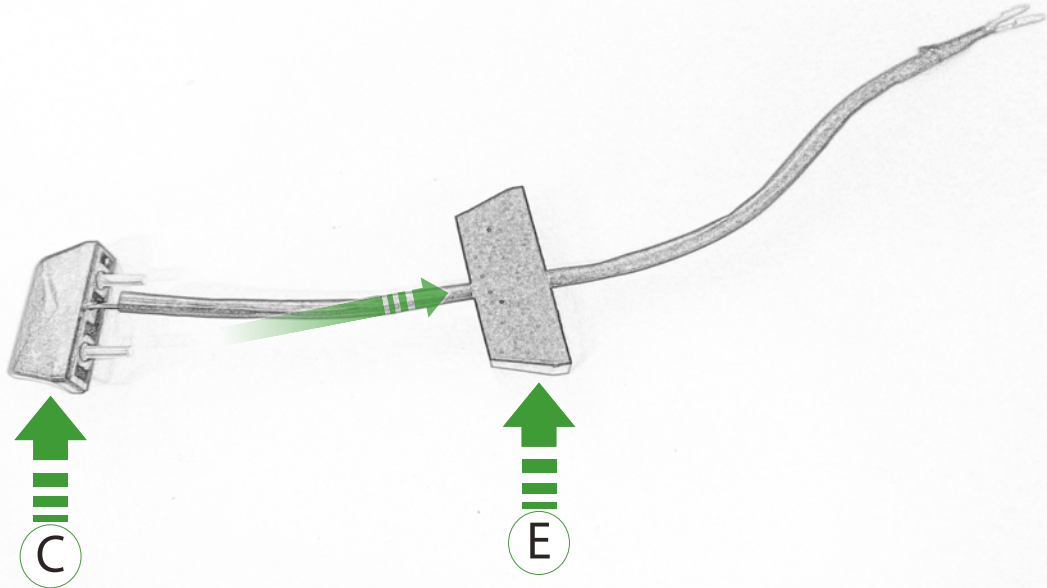

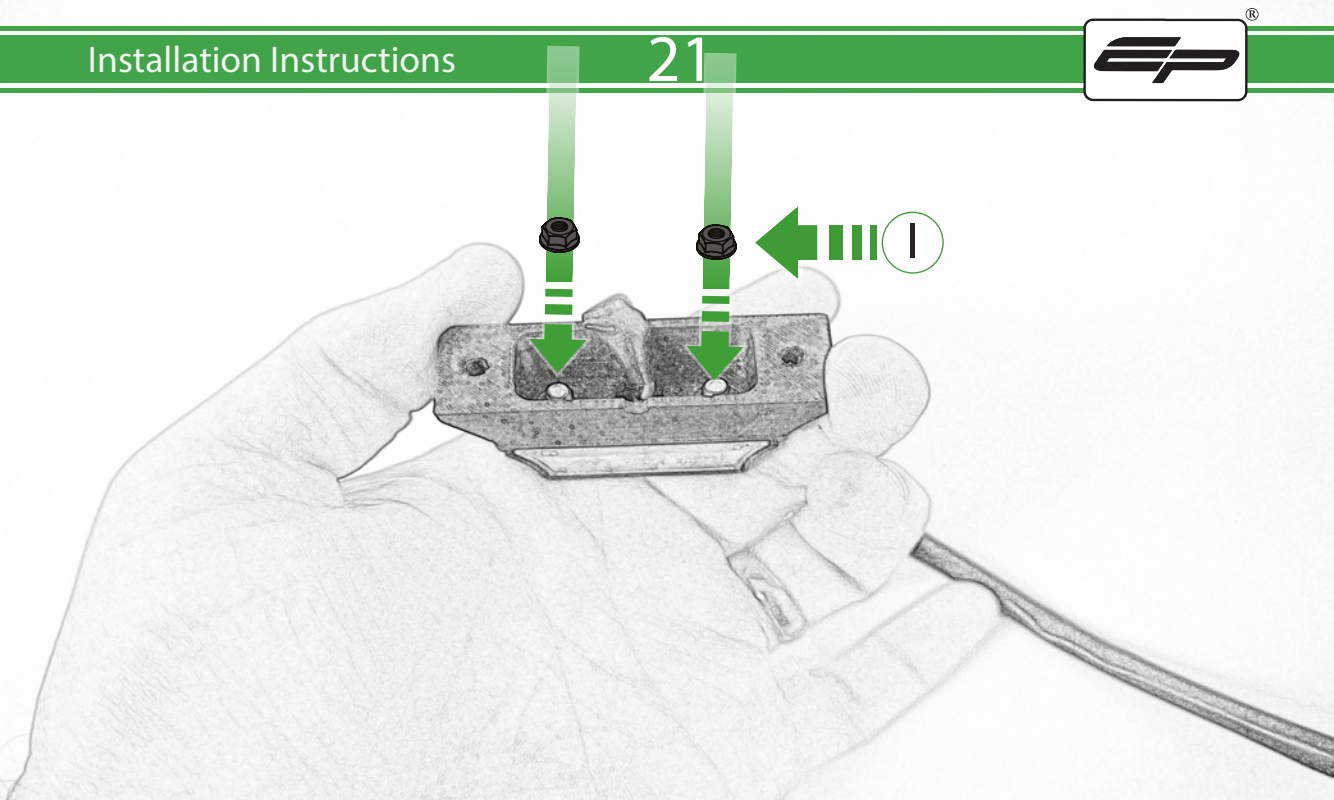

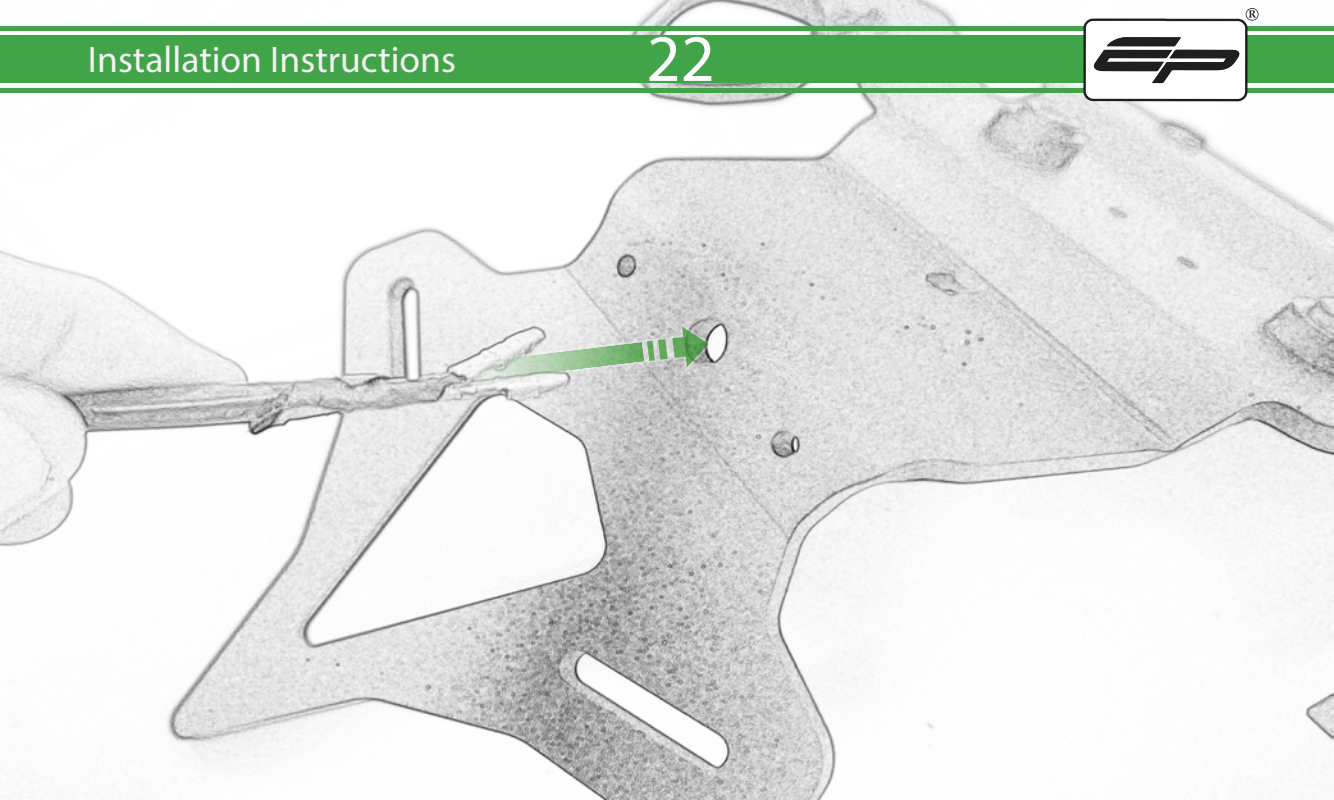

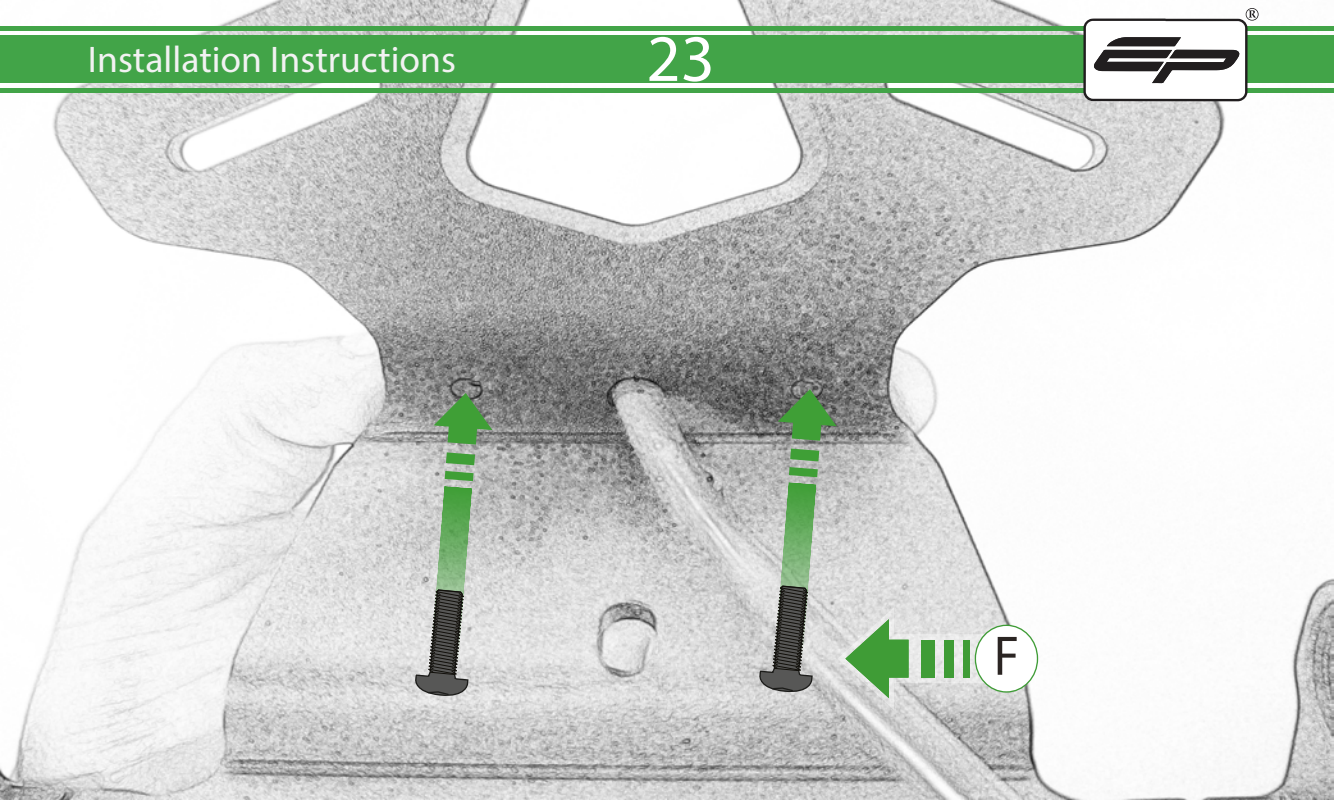

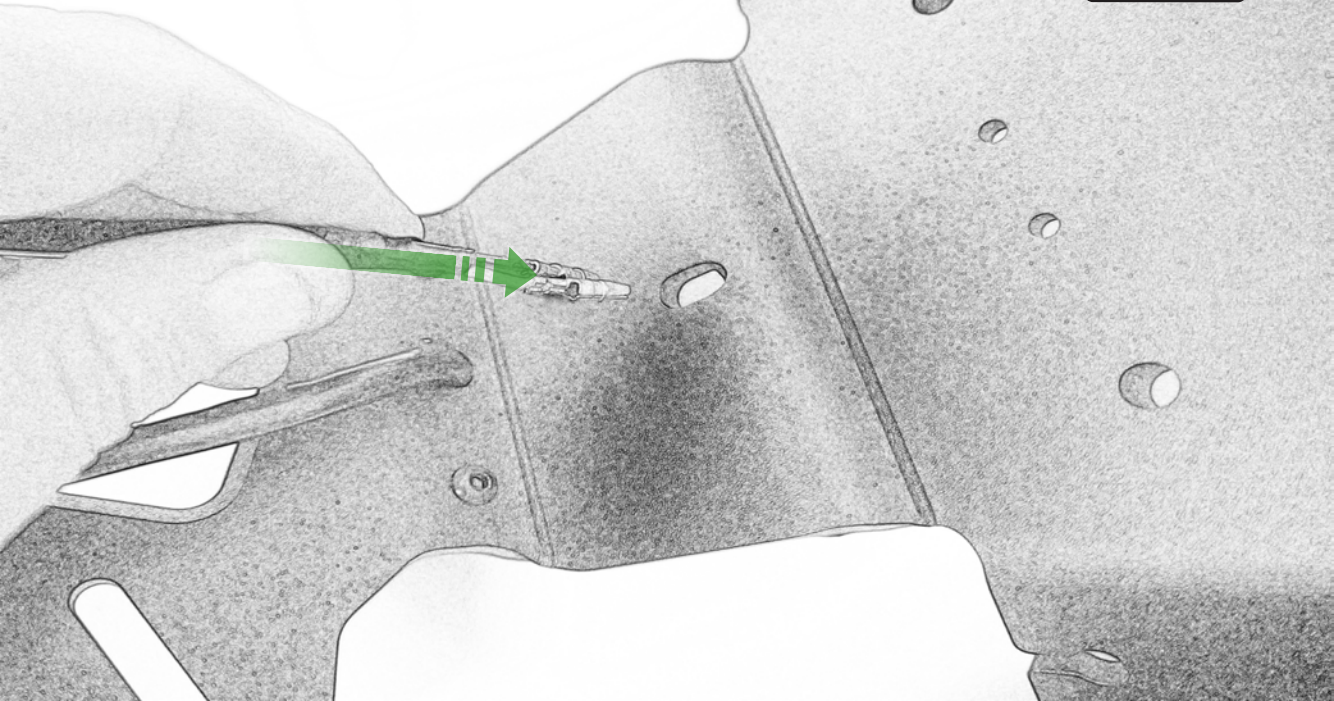

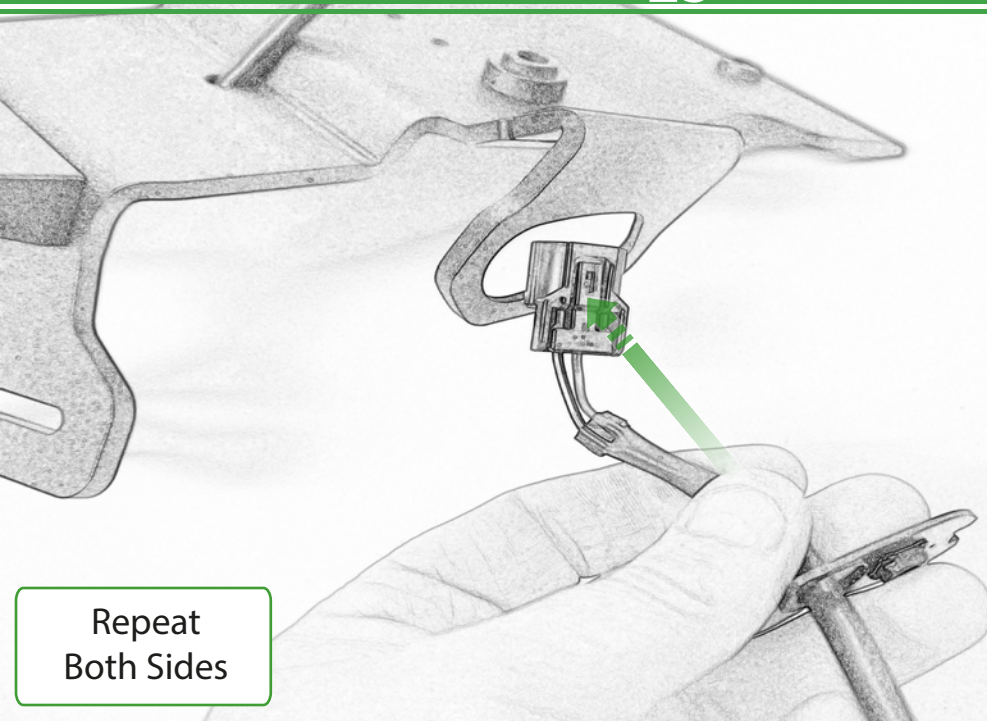

Repeat
Both Sides

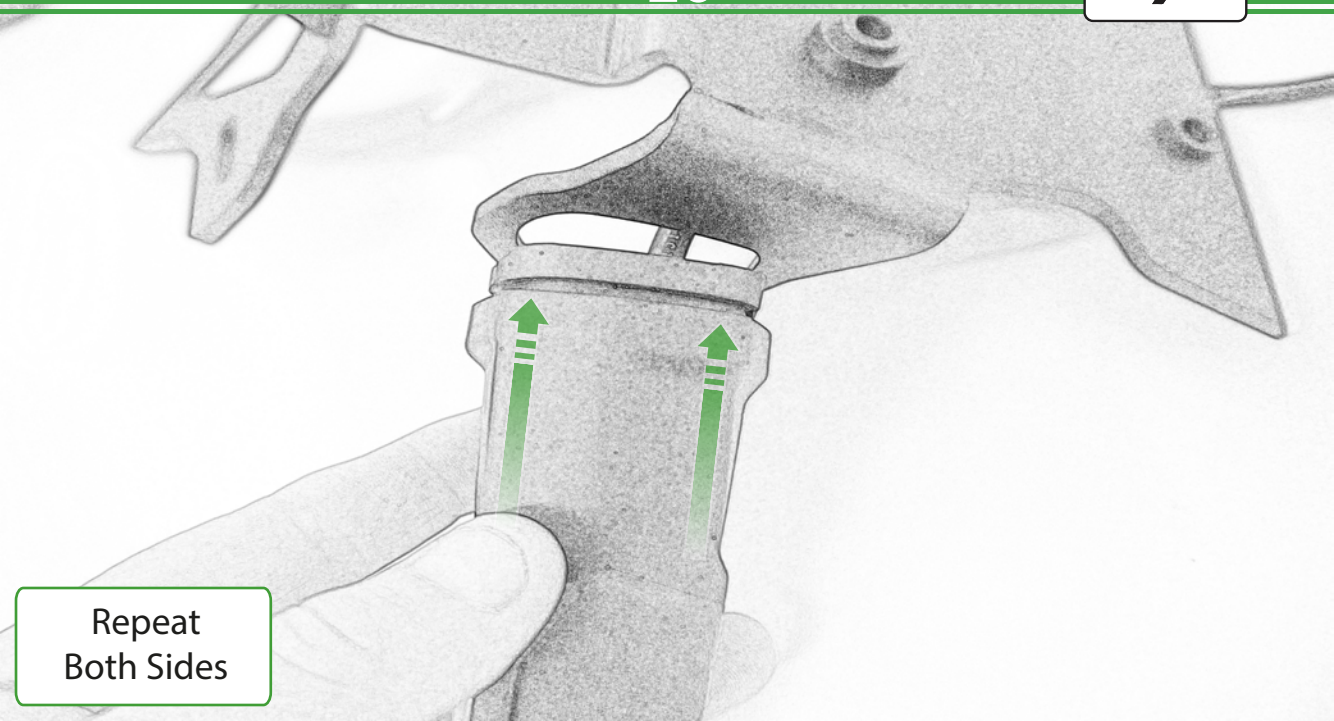

Repeat
Both Sides

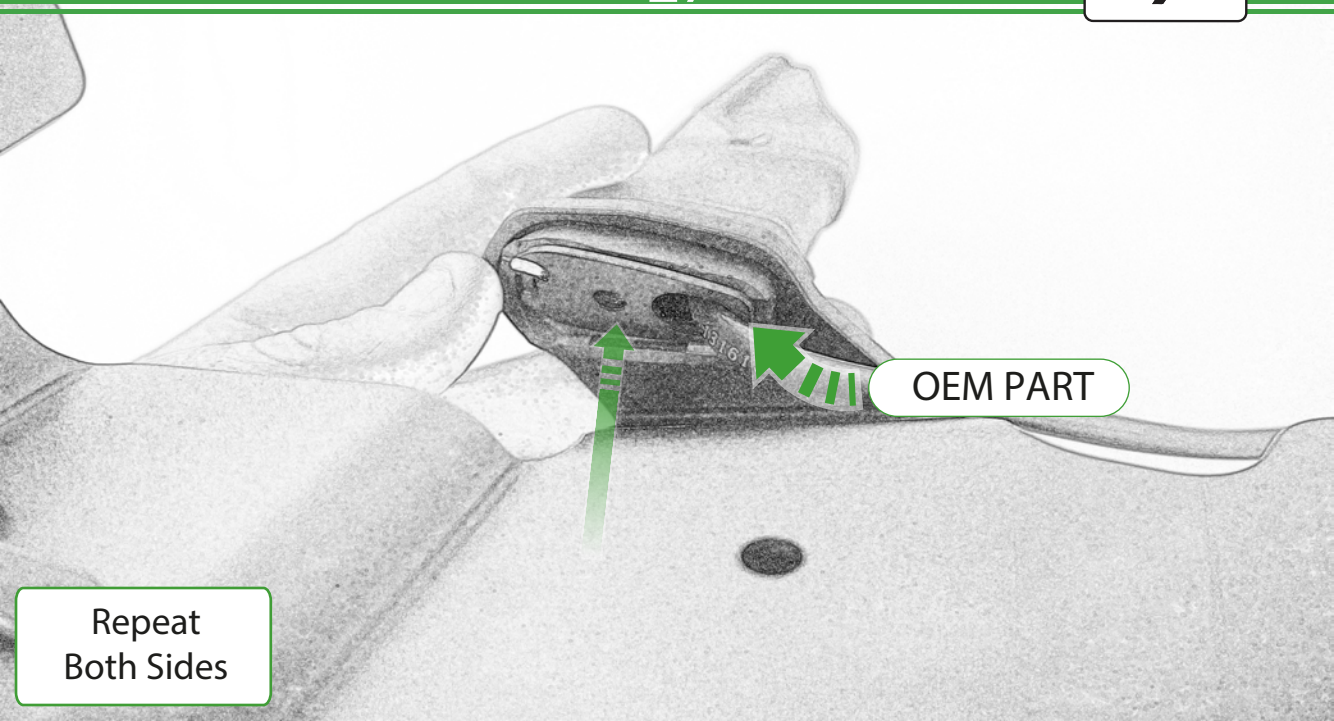

OEM PART

Repeat
Both Sides

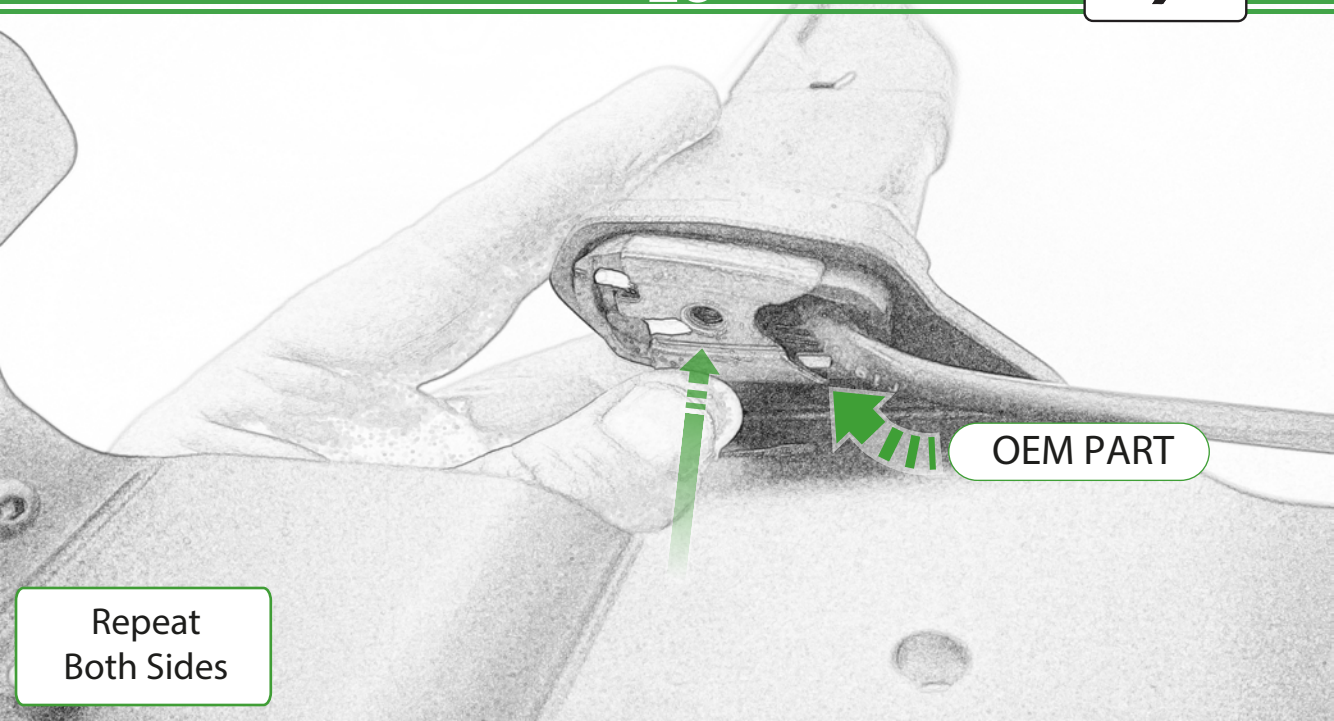

OEM PART

Repeat
Both Sides

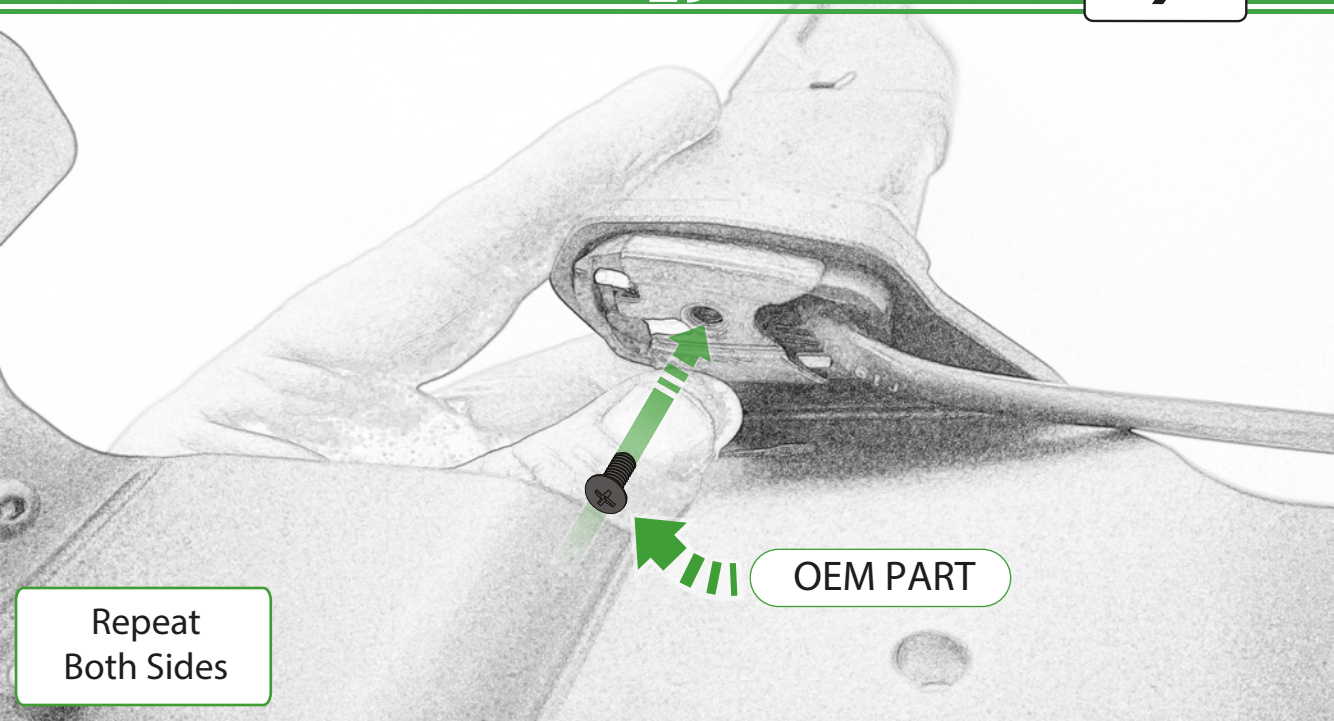

OEM PART

Repeat
Both Sides

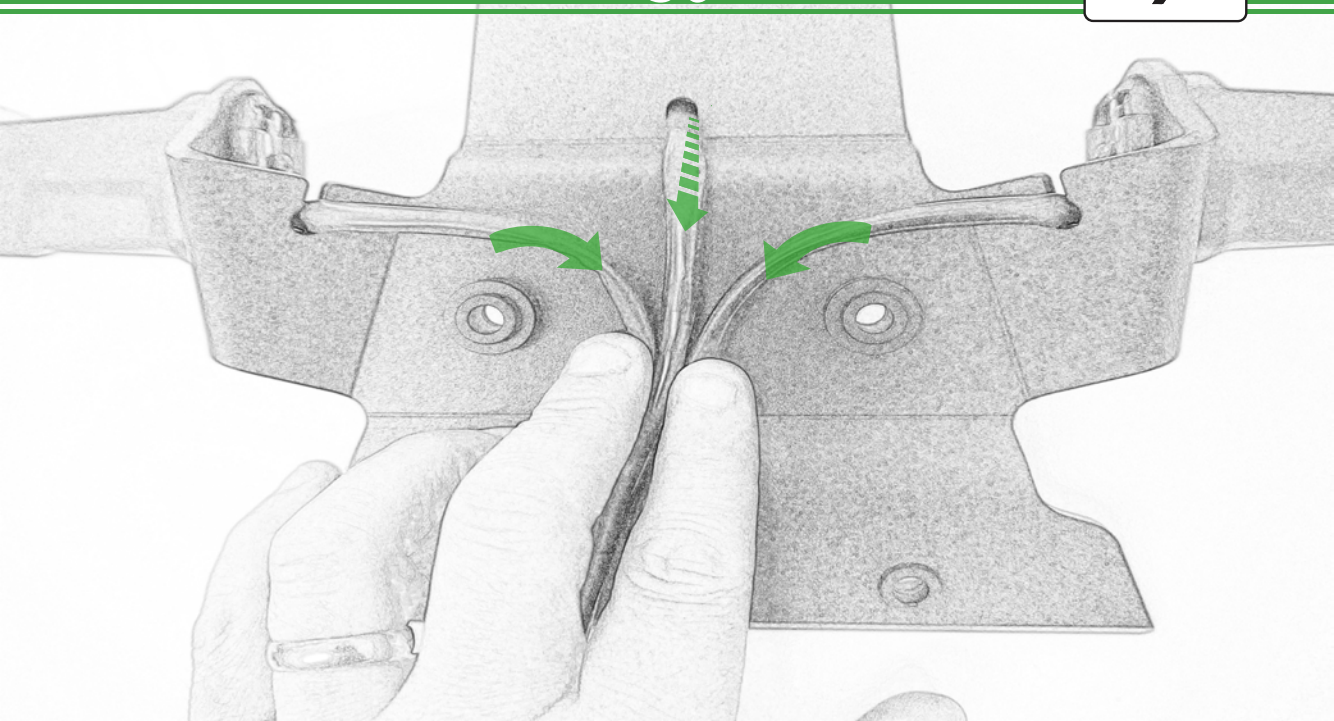

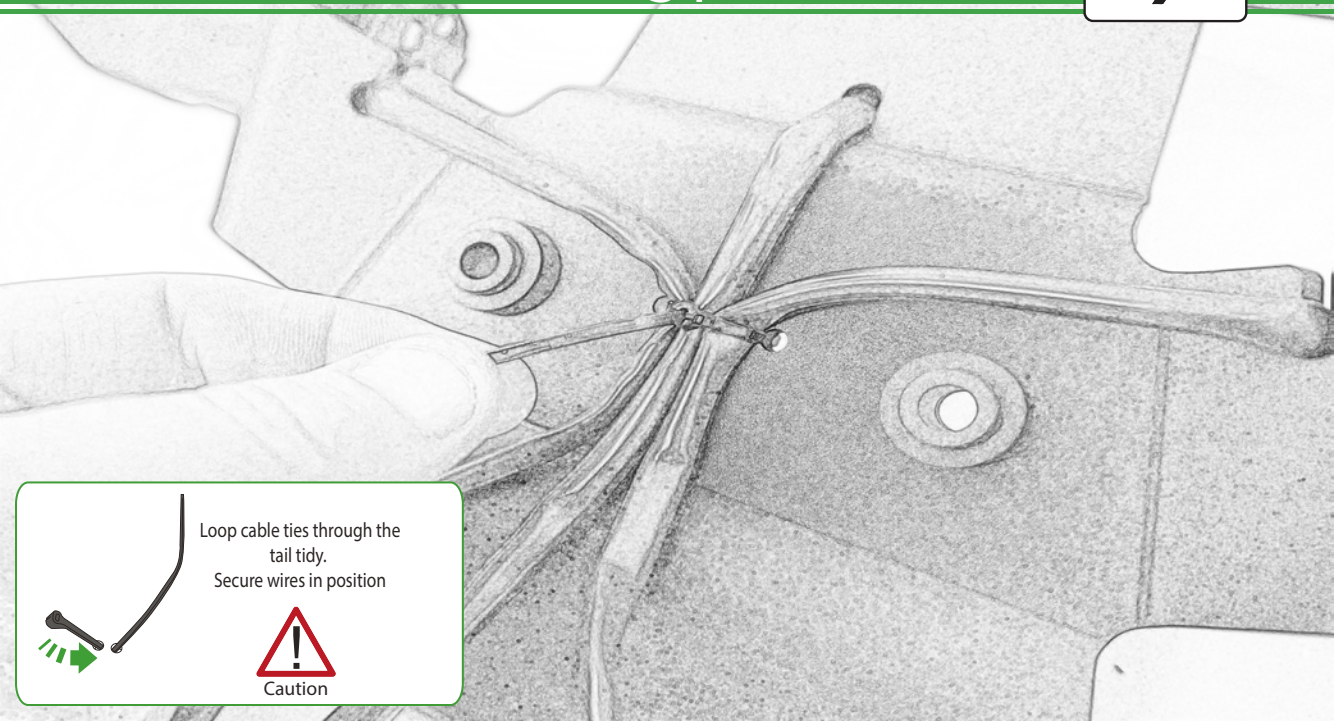

Loop cable ties through the
tail tidy.
Secure wires in position



Caution

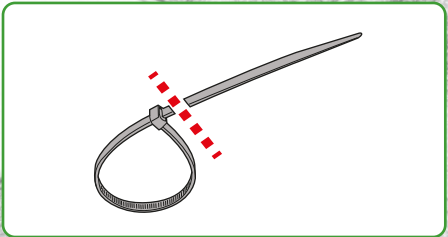
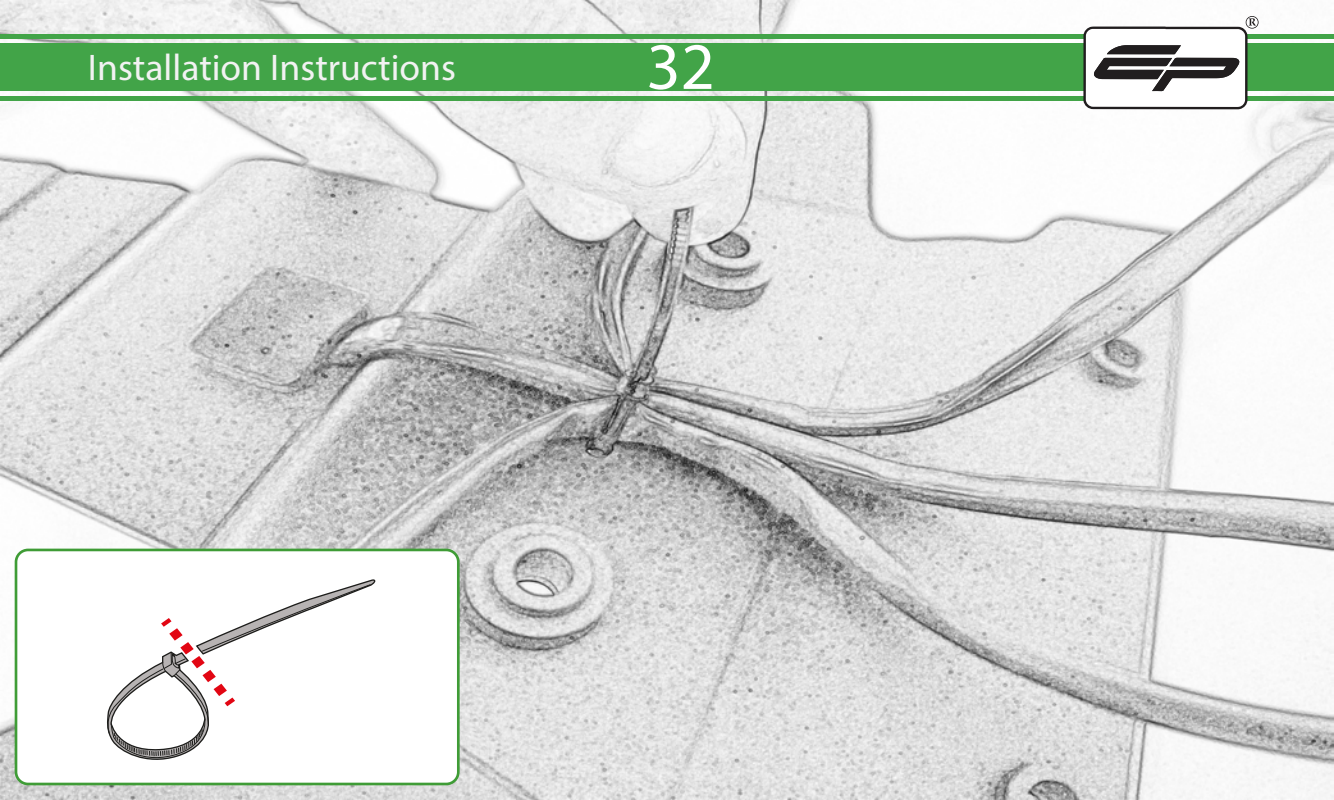

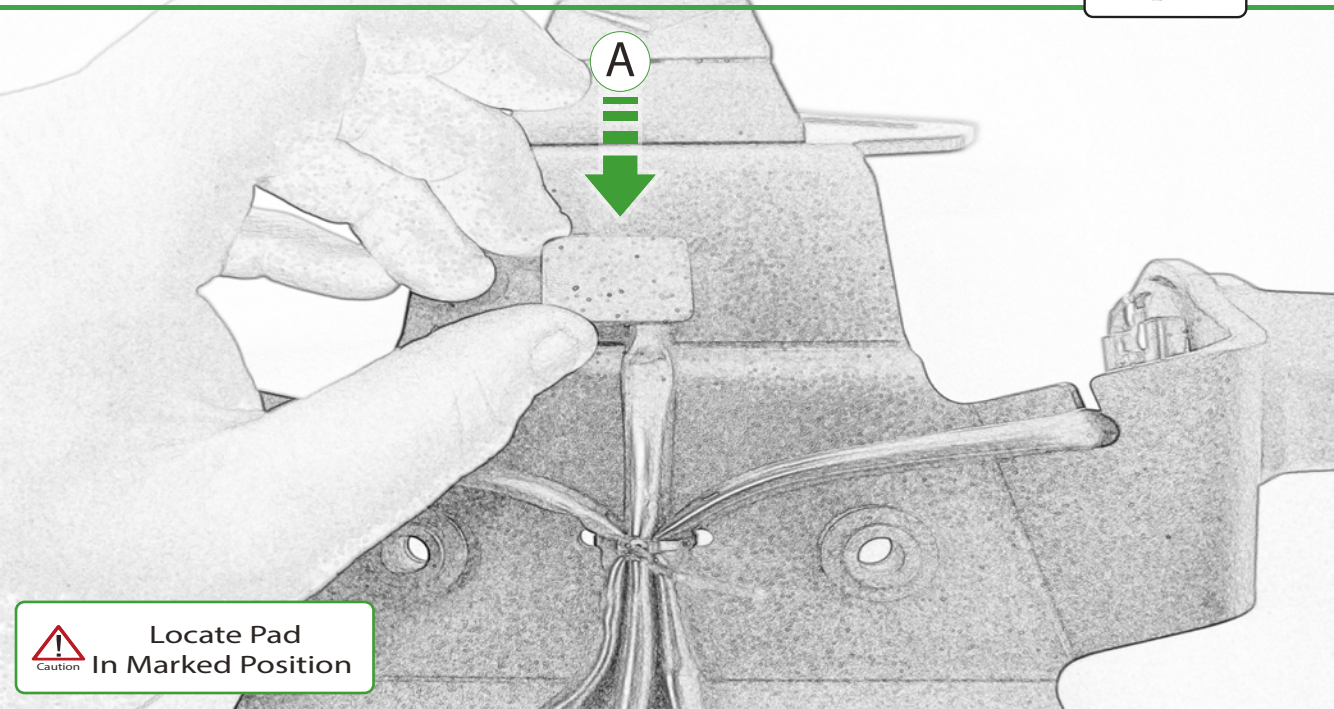

Caution

Locate Pad
In Marked Position

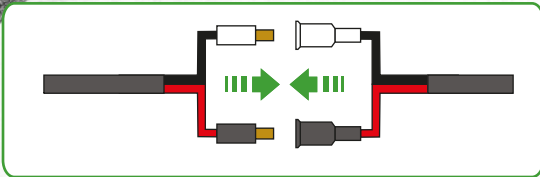
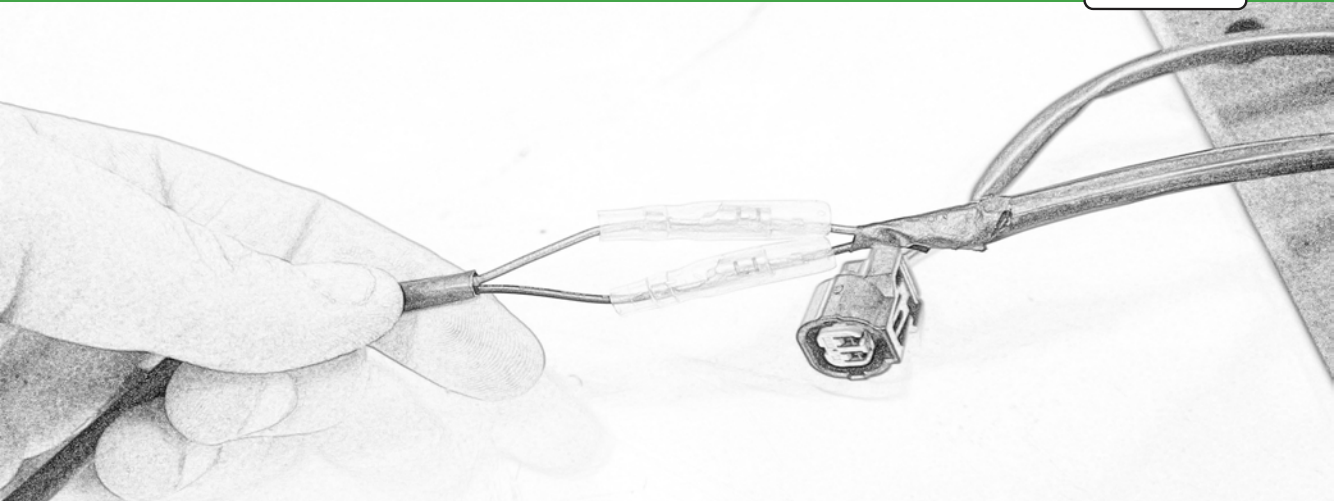

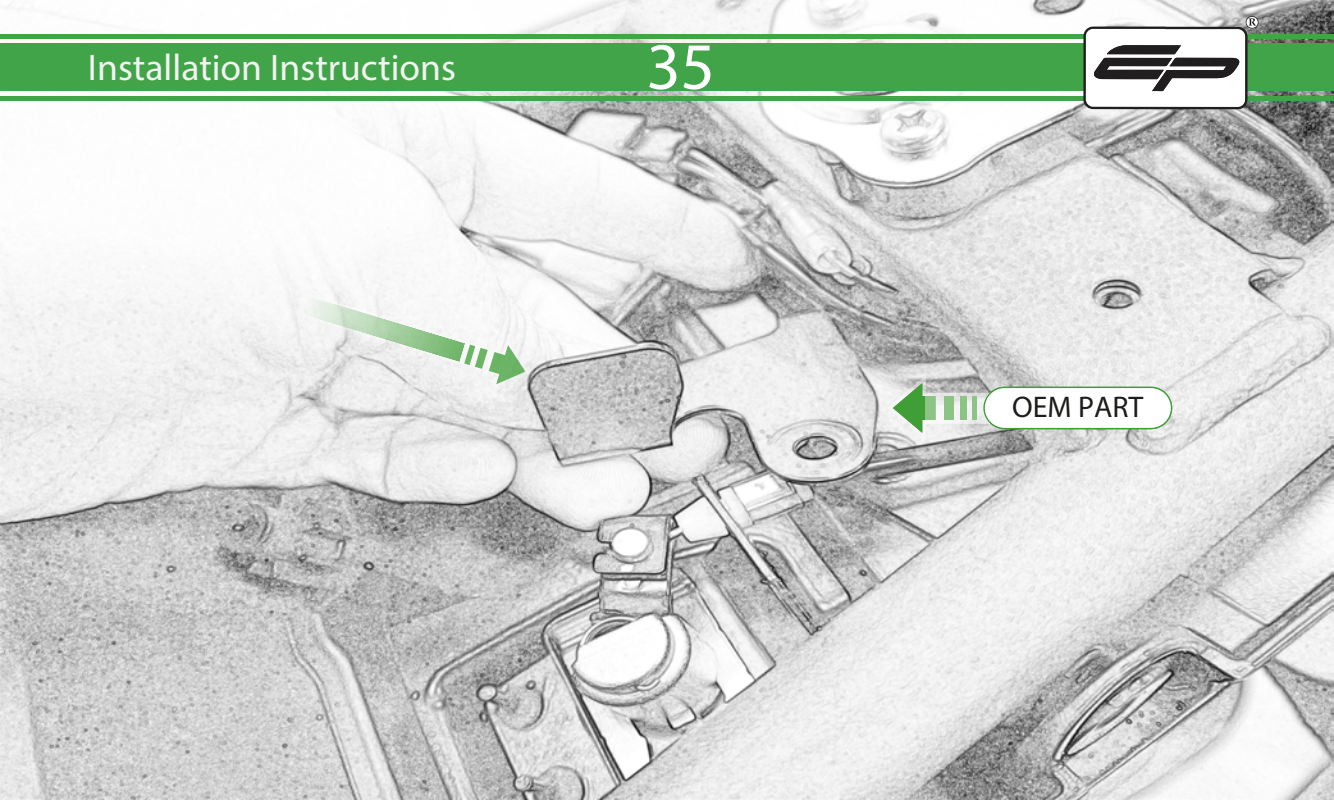

OEM PART

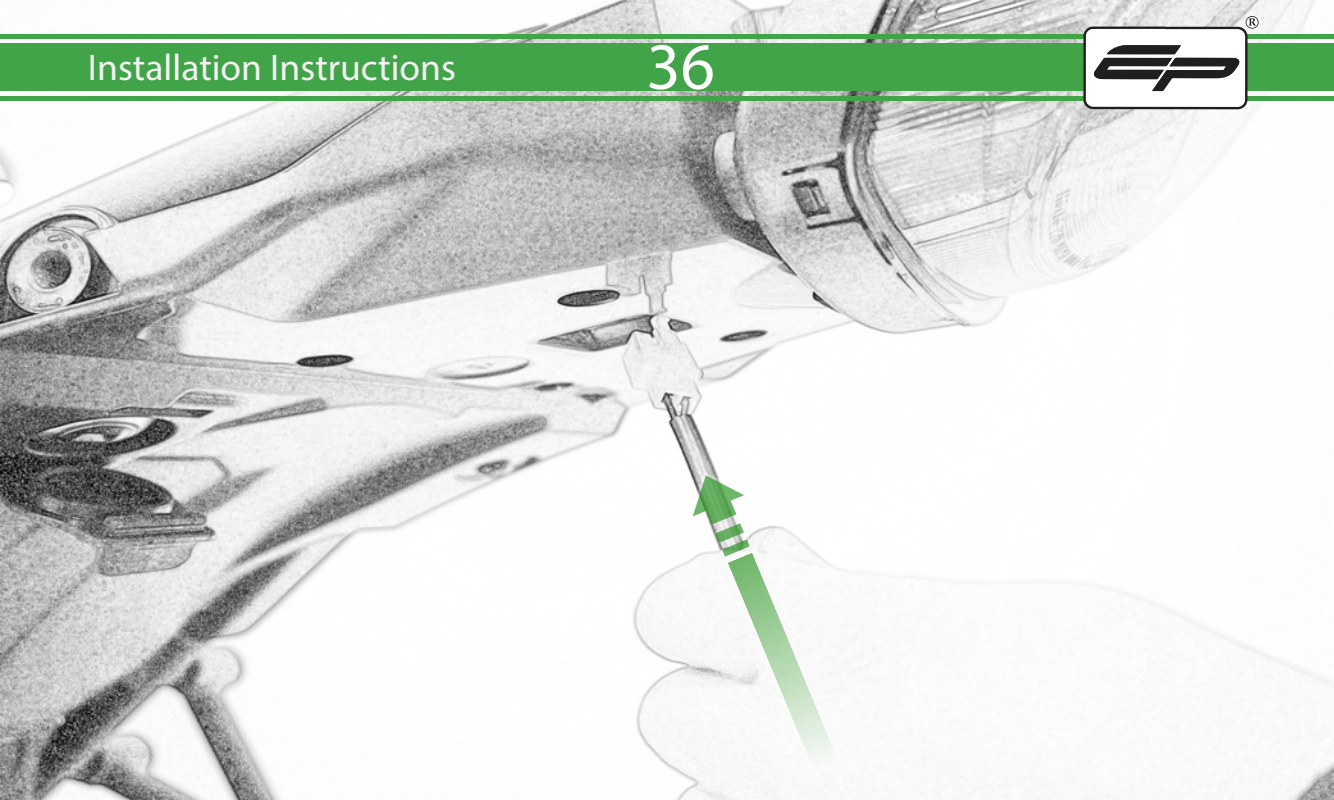

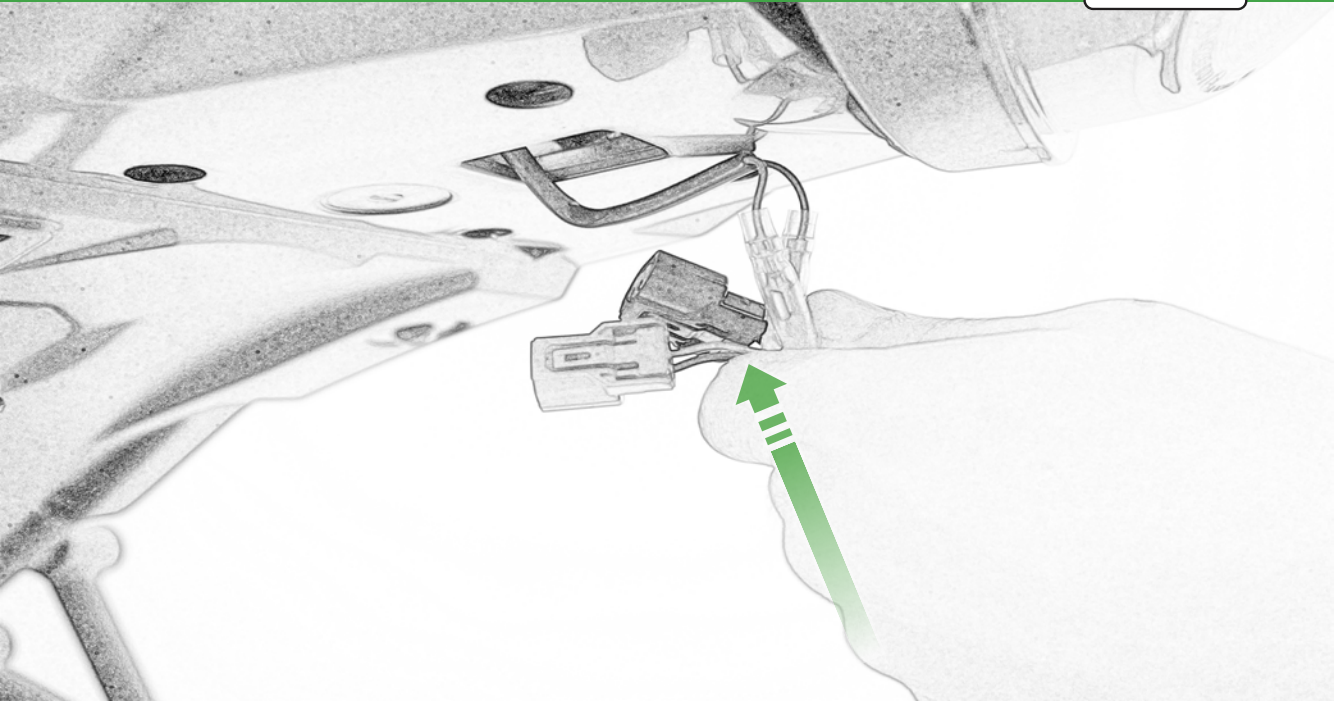

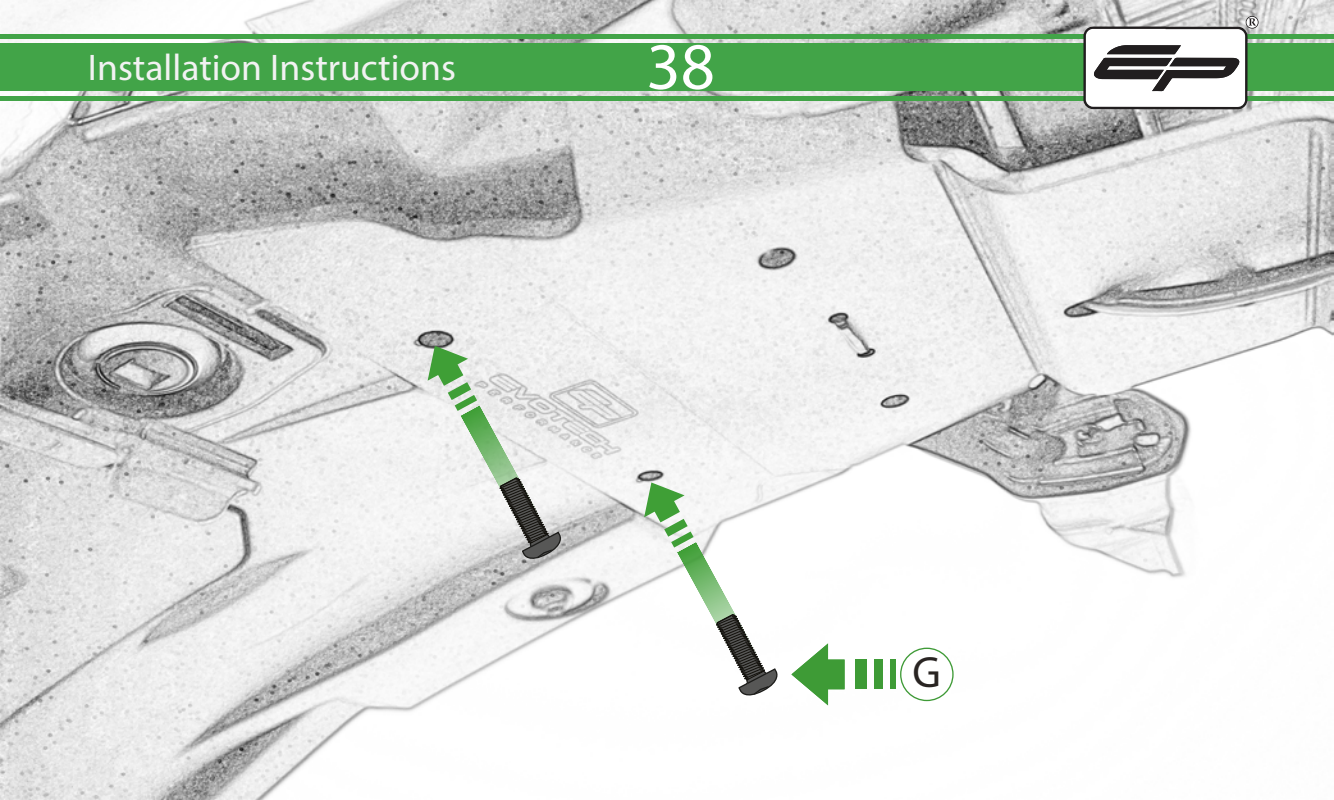

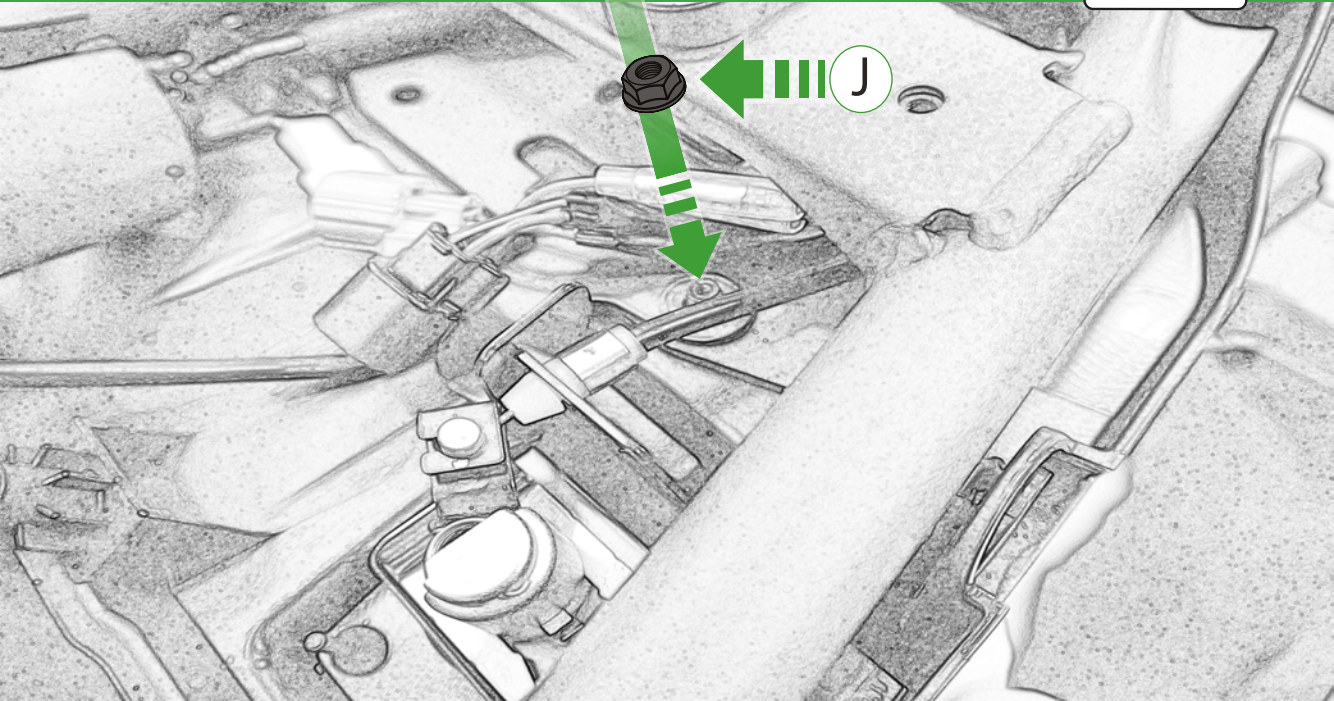

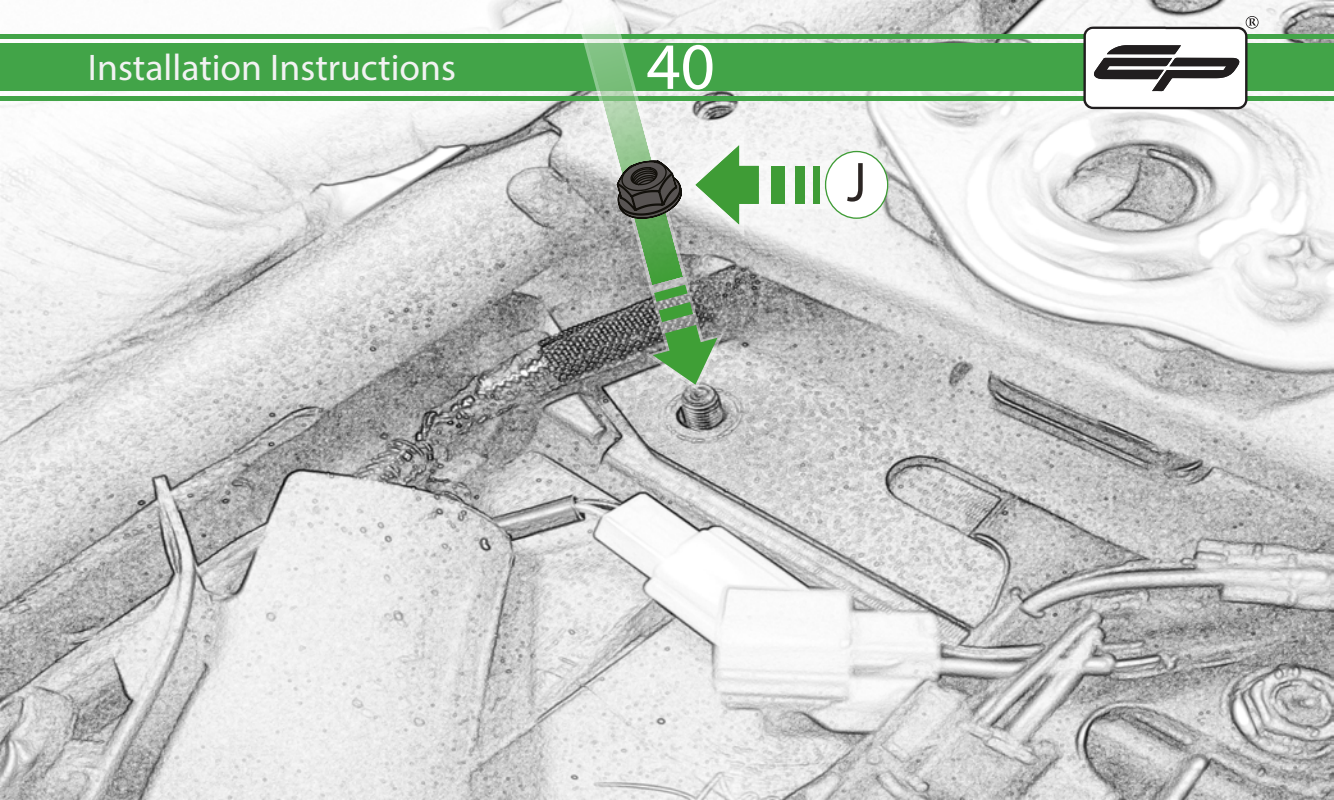

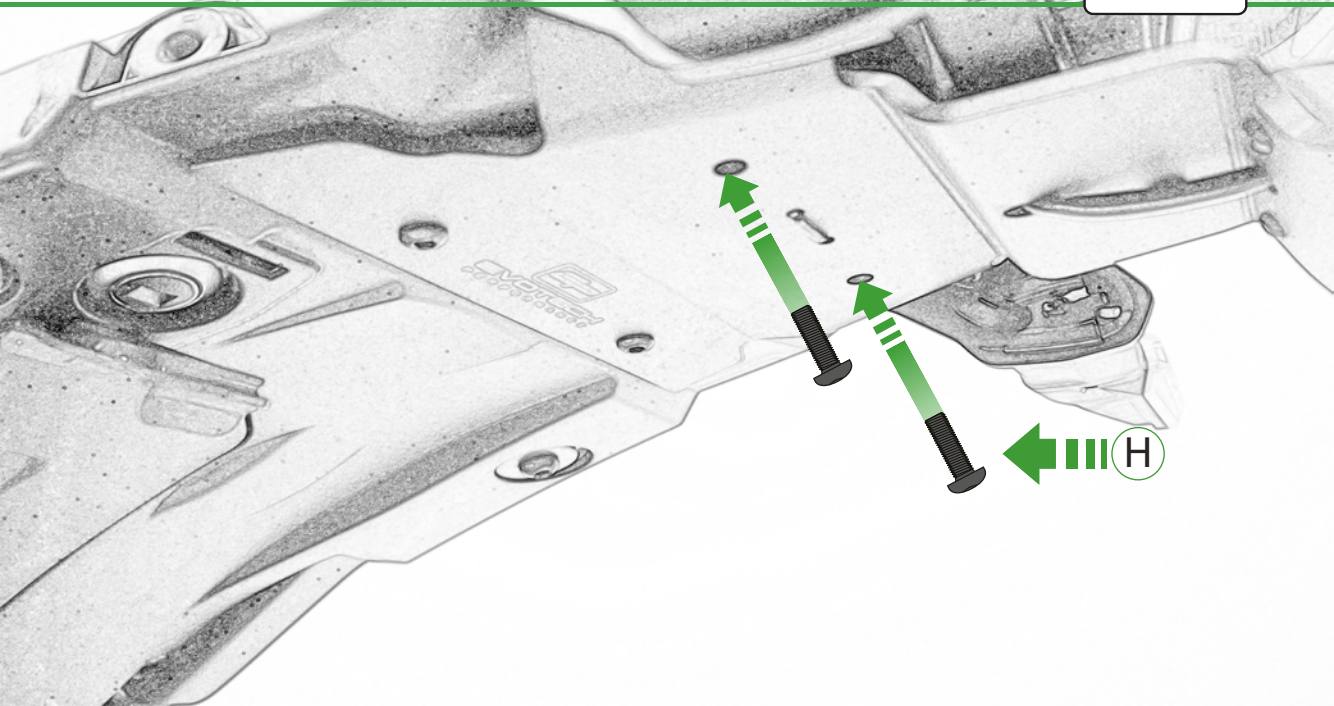

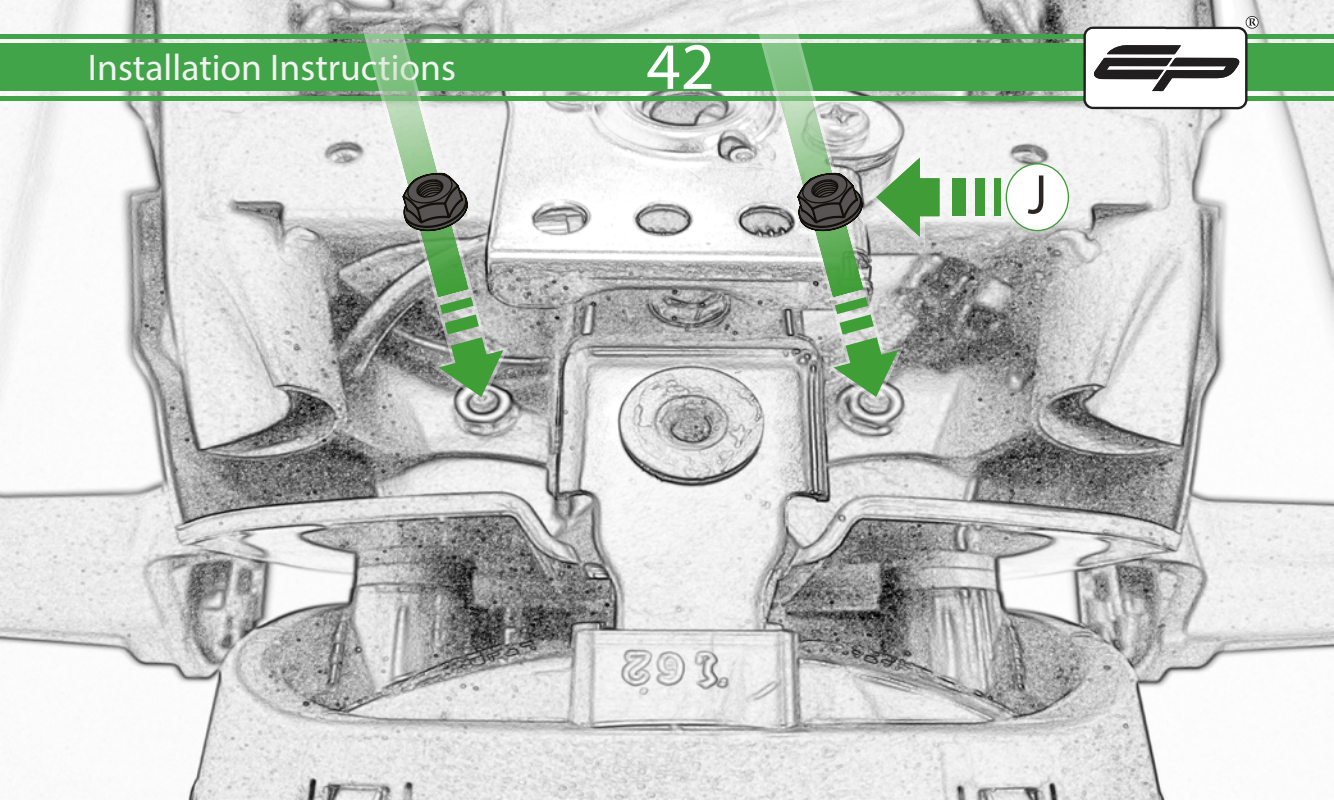

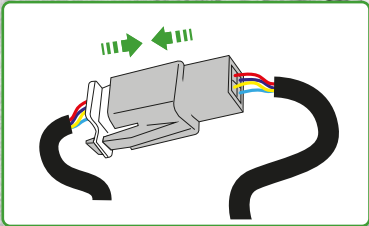
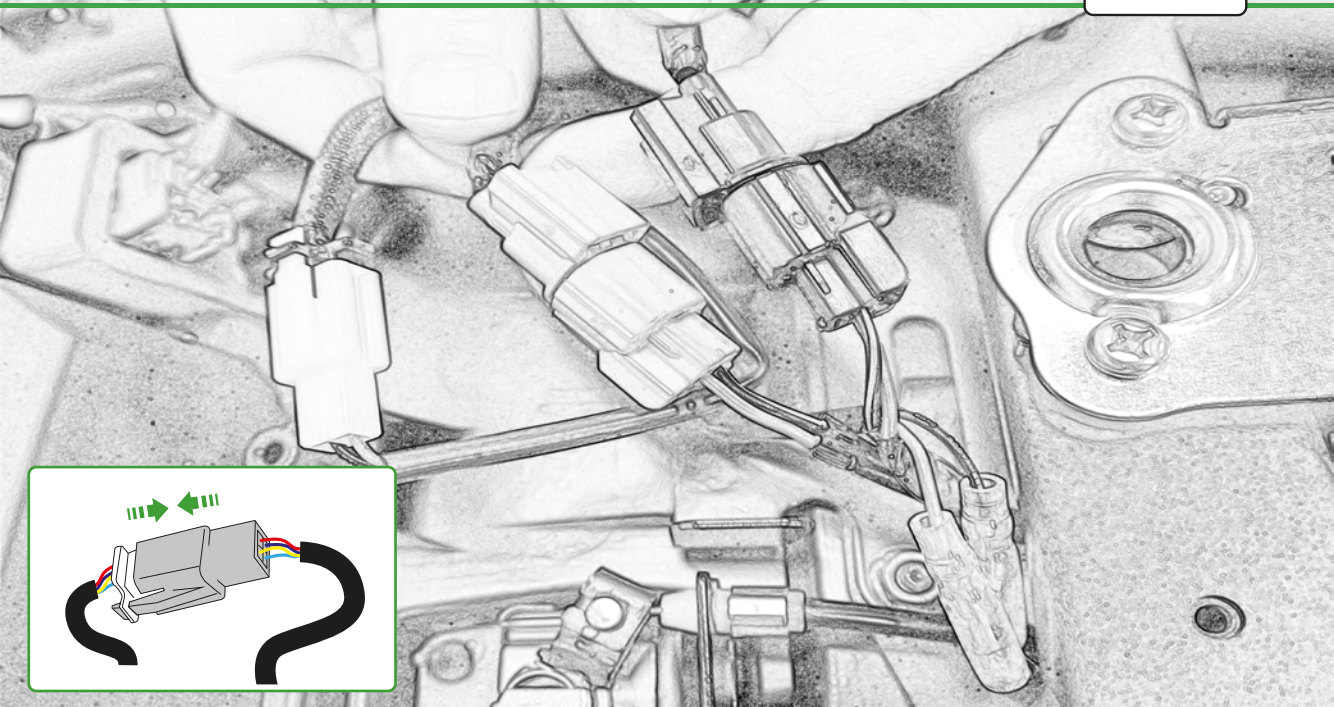

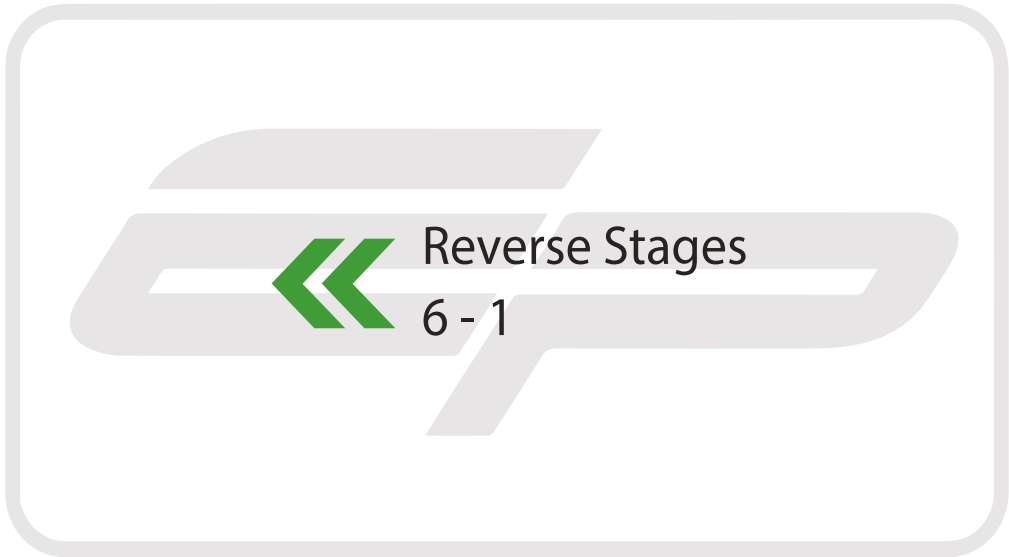

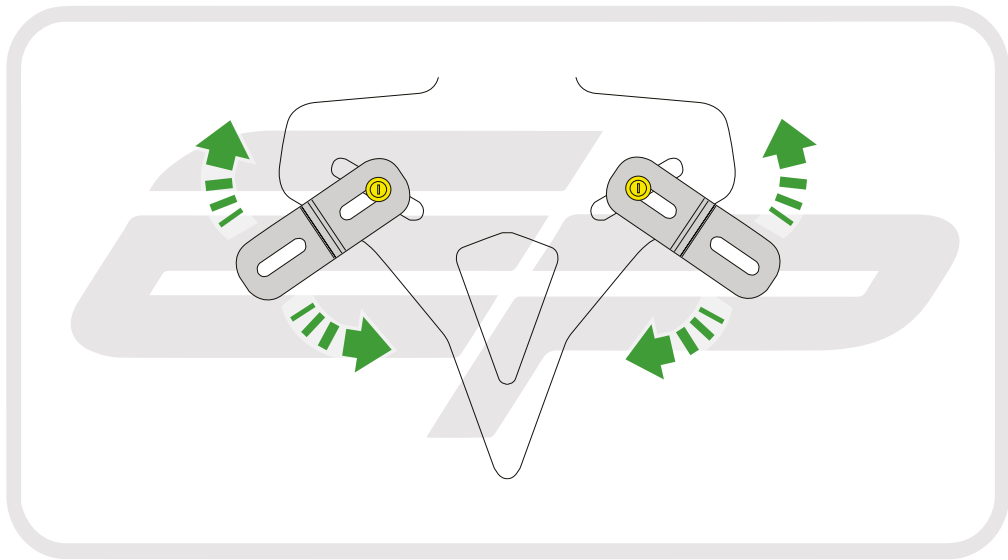

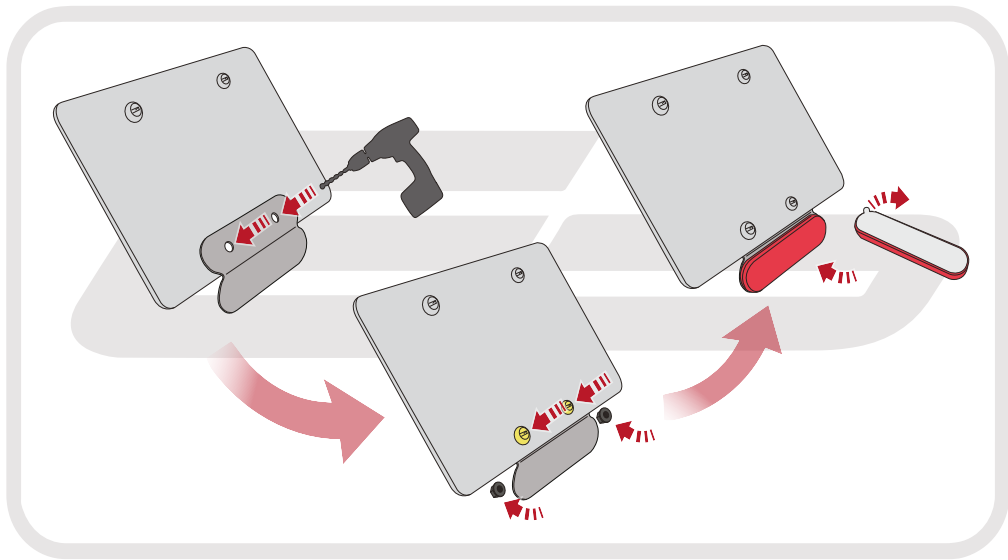



ESSENTIAL CHECKS

After installation of your tail tidy ensure that the licence plate does not contact the rear tyre when suspension is fully compressed.

Ensure all electrics including indicators, tail light, brake light and licence plate light lights are working correctly before riding the motorcycle.

It is recommended that periodic inspections are made to ensure that all fixings are fully tightend.