



**EVOTECH**®  
P E R F O R M A N C E

[www.evotech-performance.com](http://www.evotech-performance.com)

BMW F 900 R / XR Tail Tidy

Installation Instructions



## Kit Contents PRN015165

- (A) 1 x Light Body
- (B) 1 x Undertray
- (C) 1 x Undertray Plate
- (D) 1 x Numberplate Bracket
- (E) 1 x Inner Support Bracket
- (F) 2 x Indicator Spacer
- (G) 2 x M4 x 10 Button Head Bolts
- (H) 2 x Special Washer
- (I) 2 x M5 x 16 Button Head Bolts
- (J) 2 x Undertray Spacer A
- (K) 2 x Undertray Spacer B
- (L) 4 x M6 x 16mm Button Head Bolts

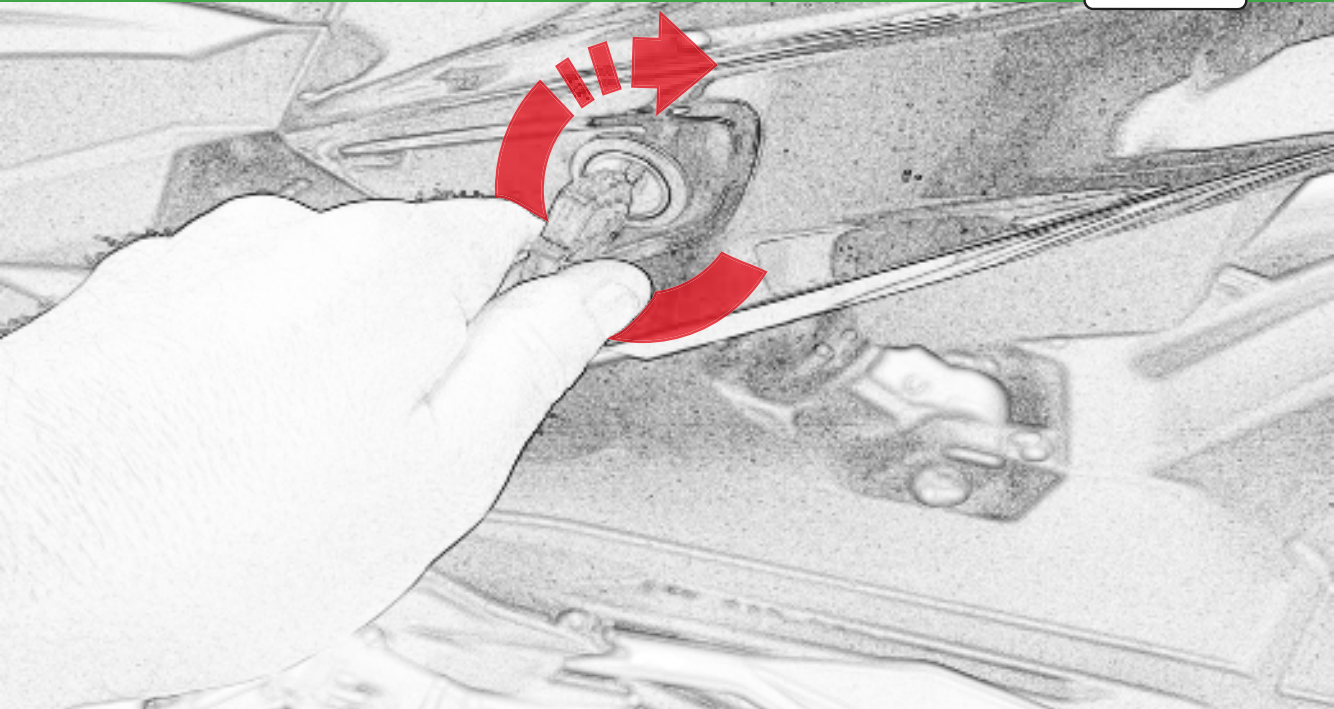

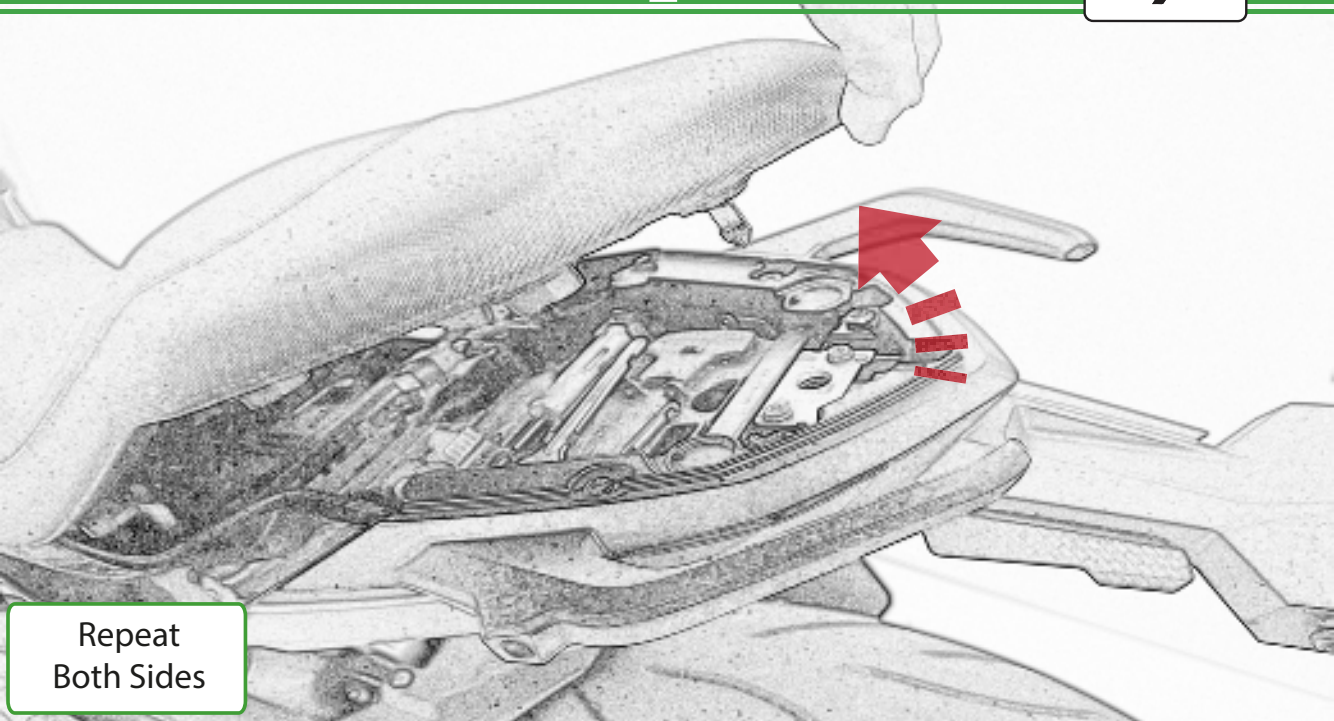

Repeat  
Both Sides

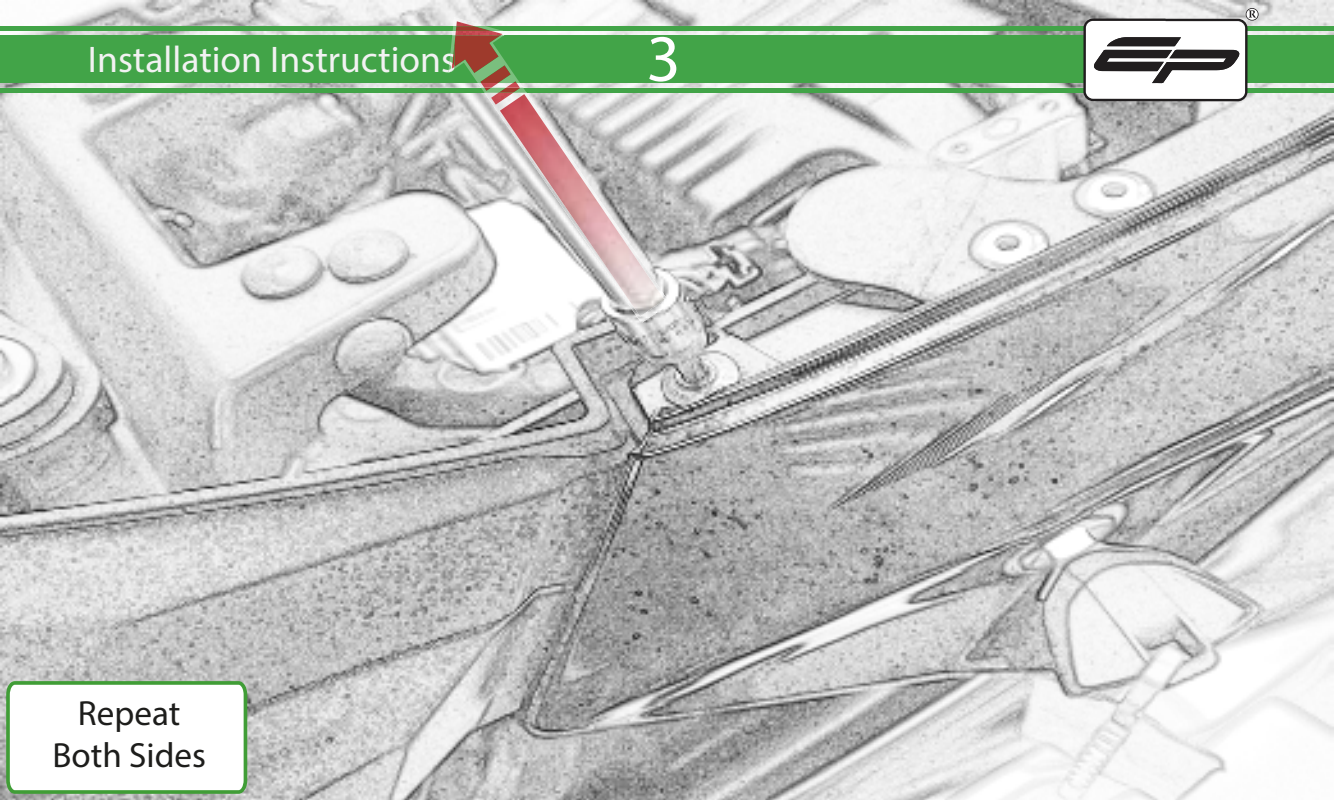

Repeat  
Both Sides

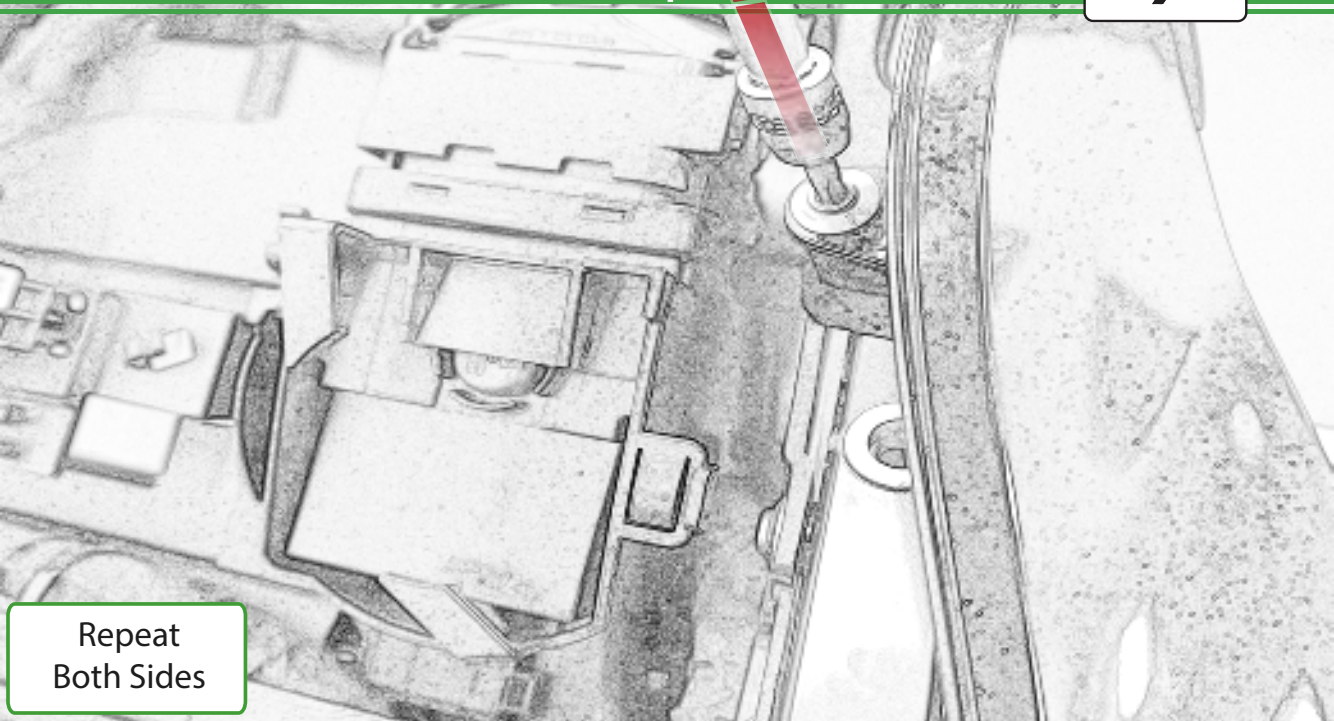

Repeat  
Both Sides

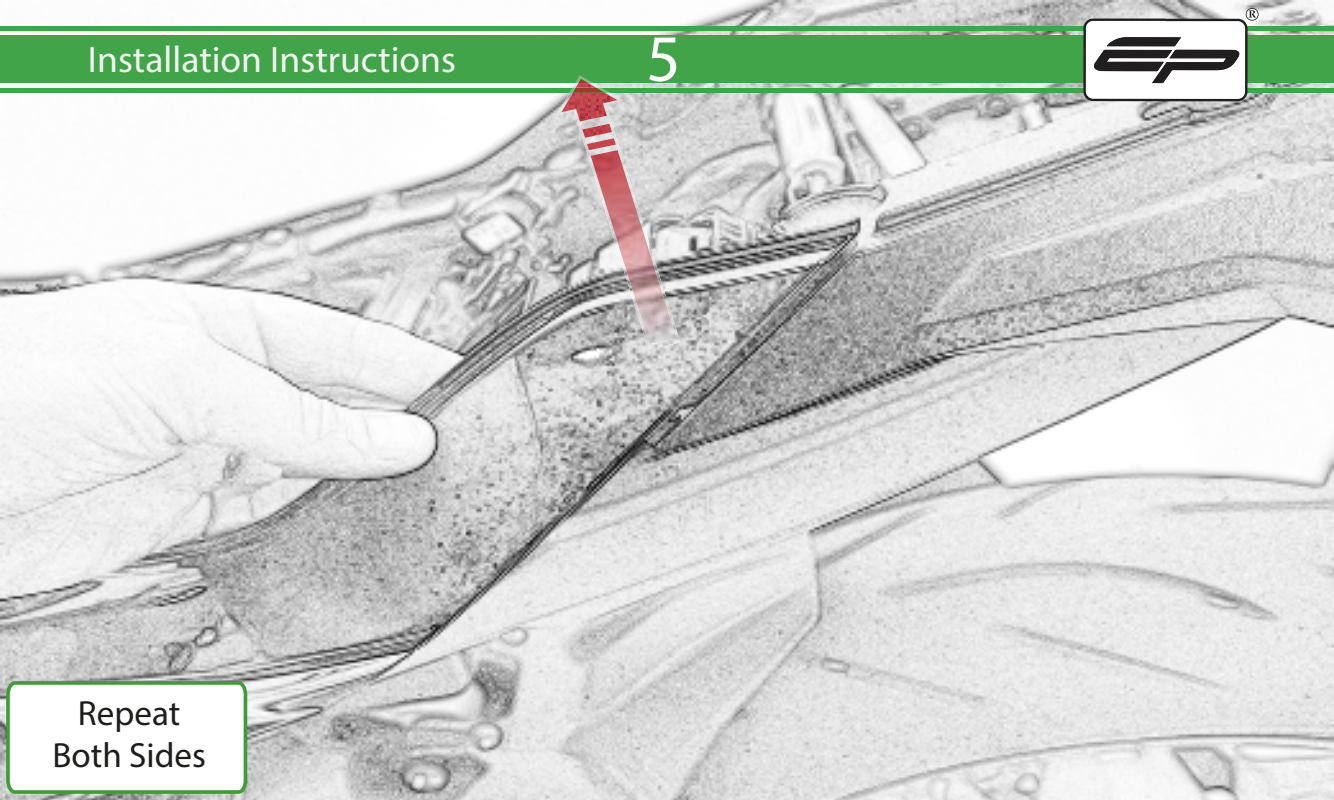

Repeat  
Both Sides

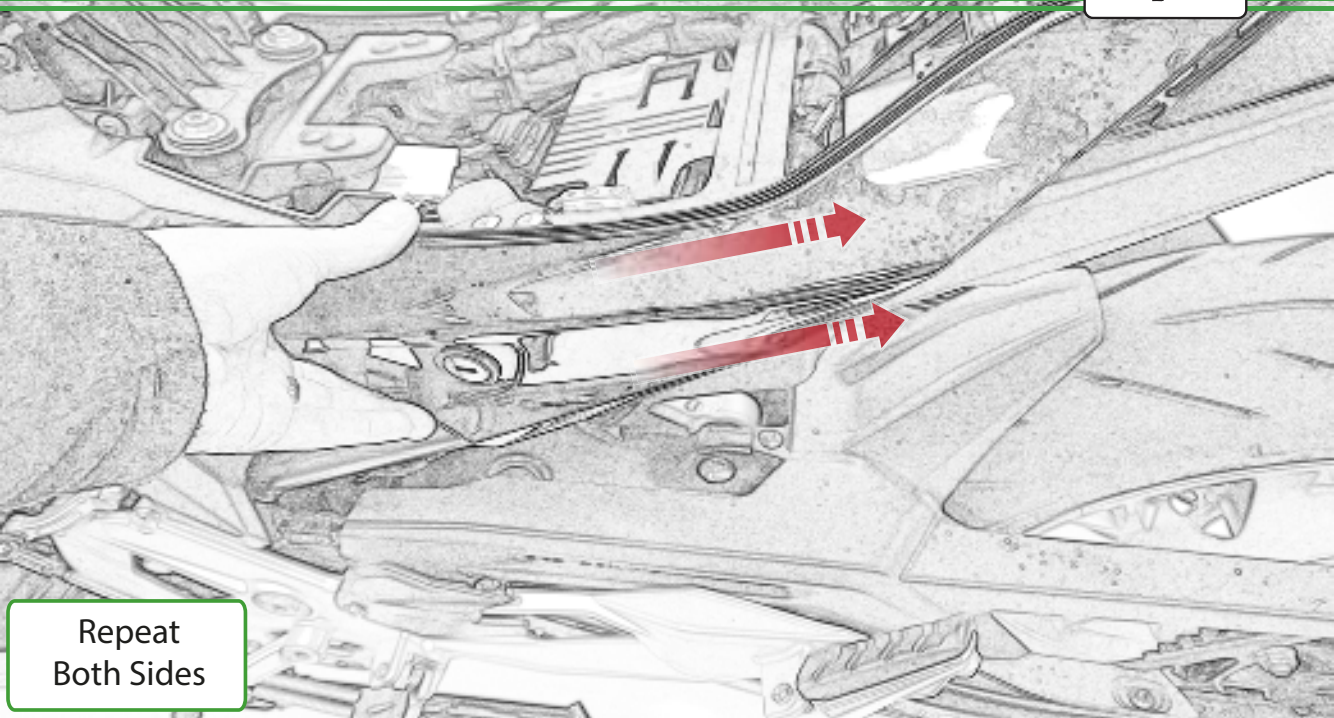

Repeat  
Both Sides



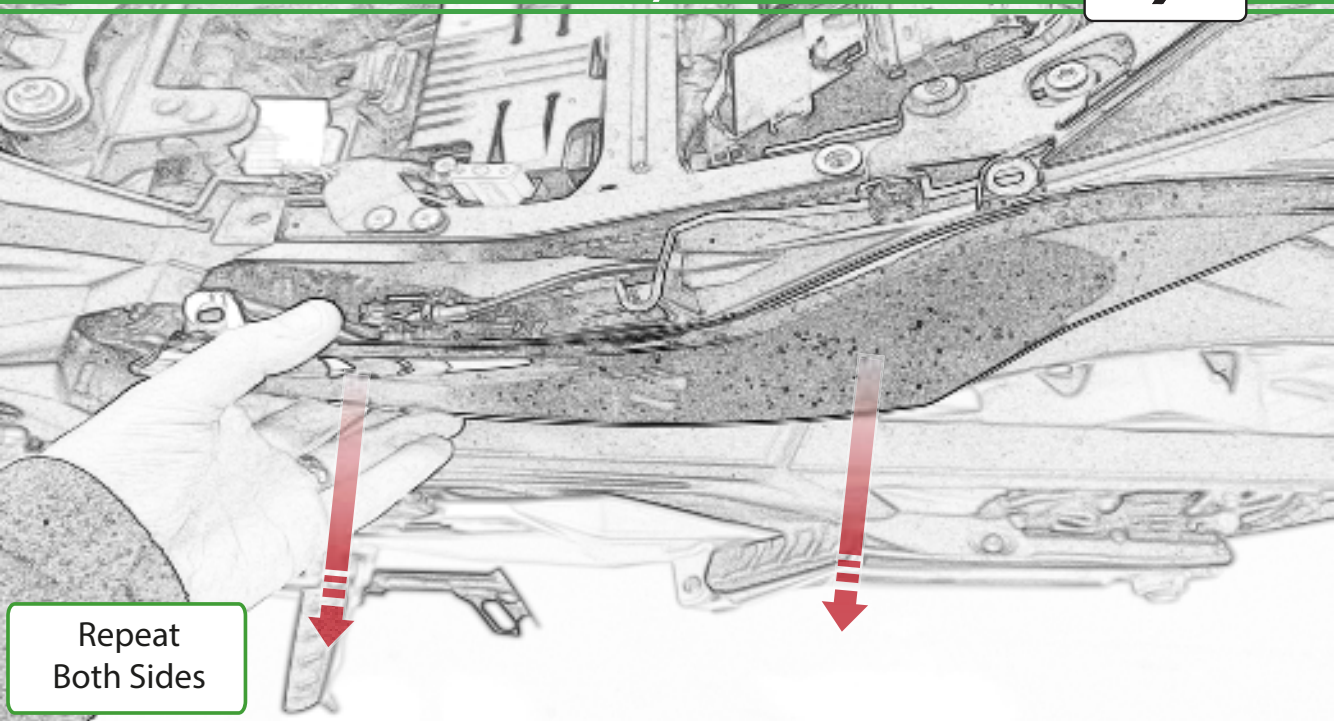

Repeat  
Both Sides

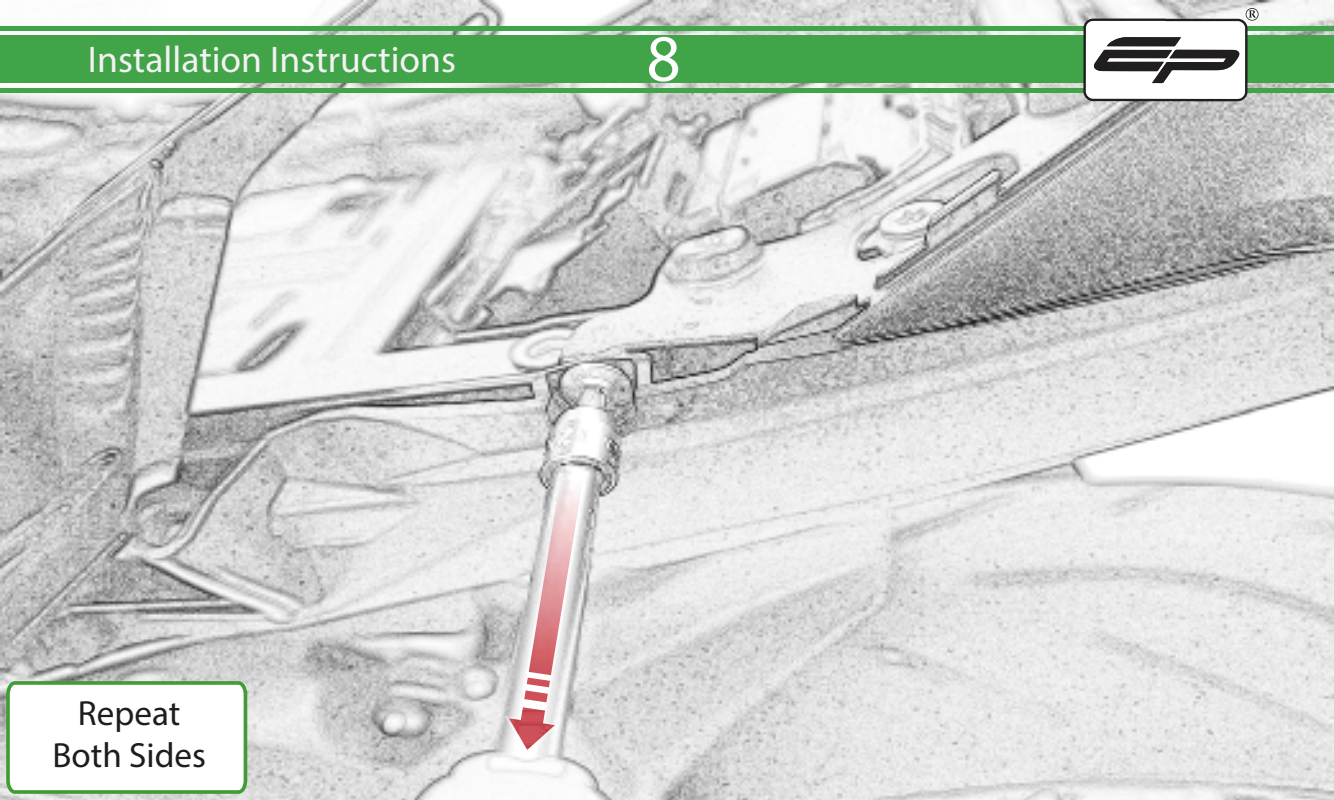

Repeat  
Both Sides

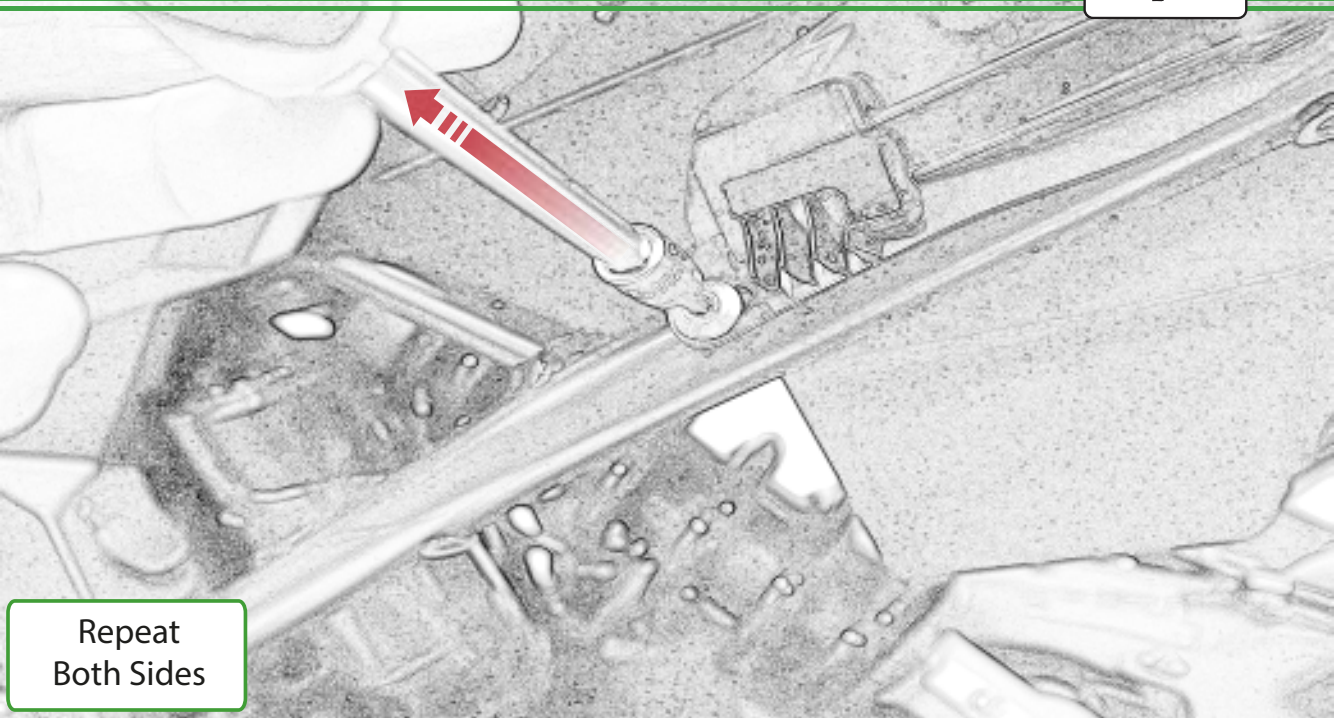

Repeat  
Both Sides

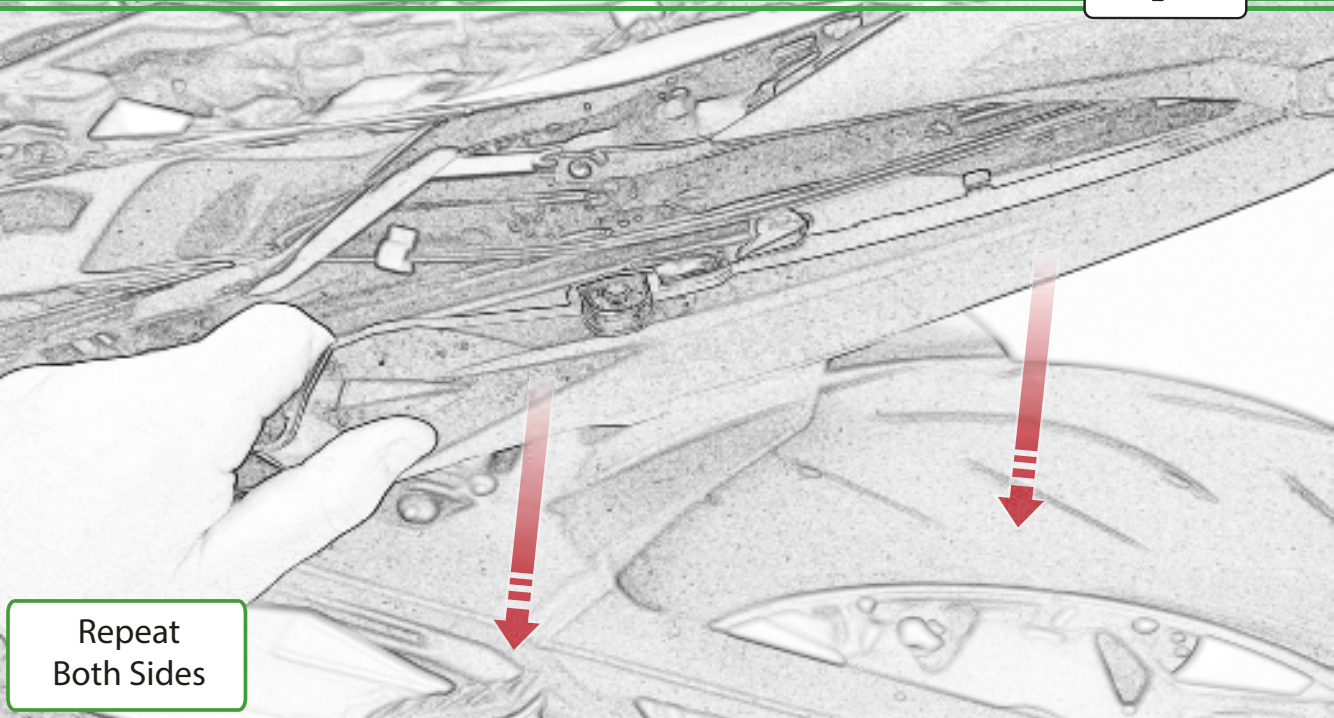

Repeat  
Both Sides

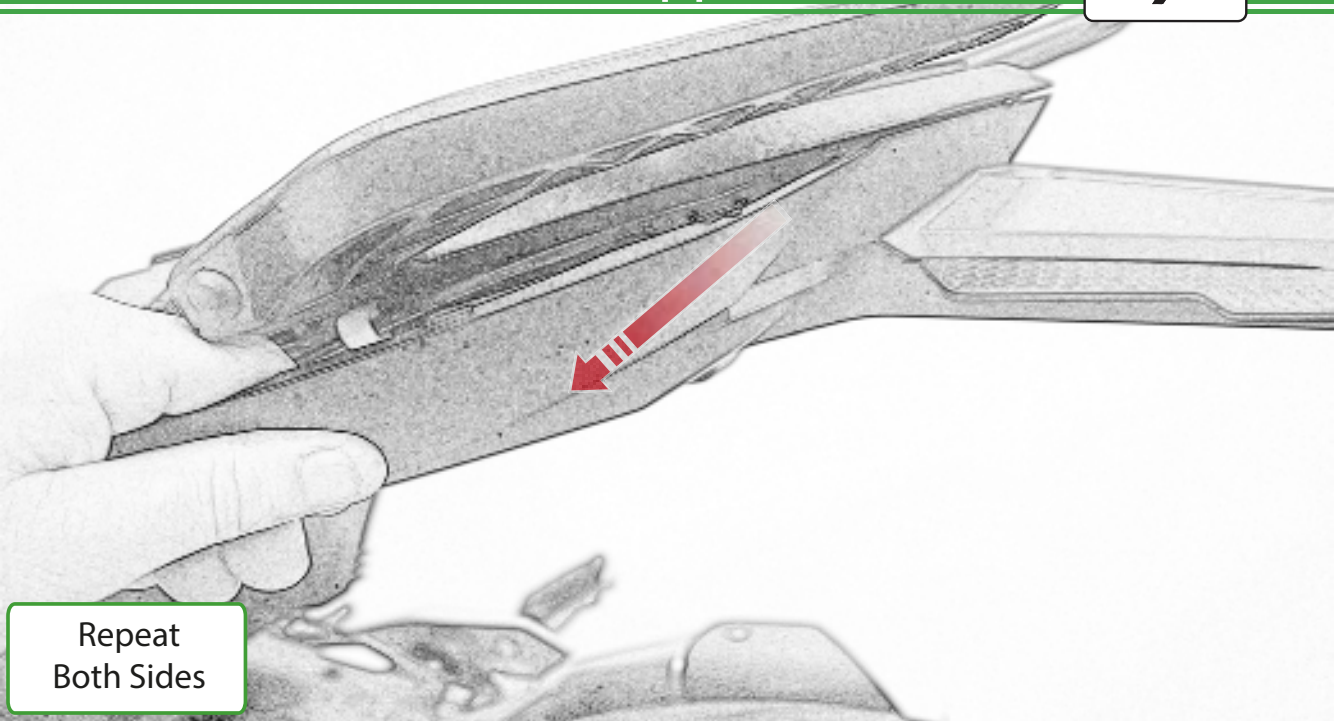

Repeat  
Both Sides

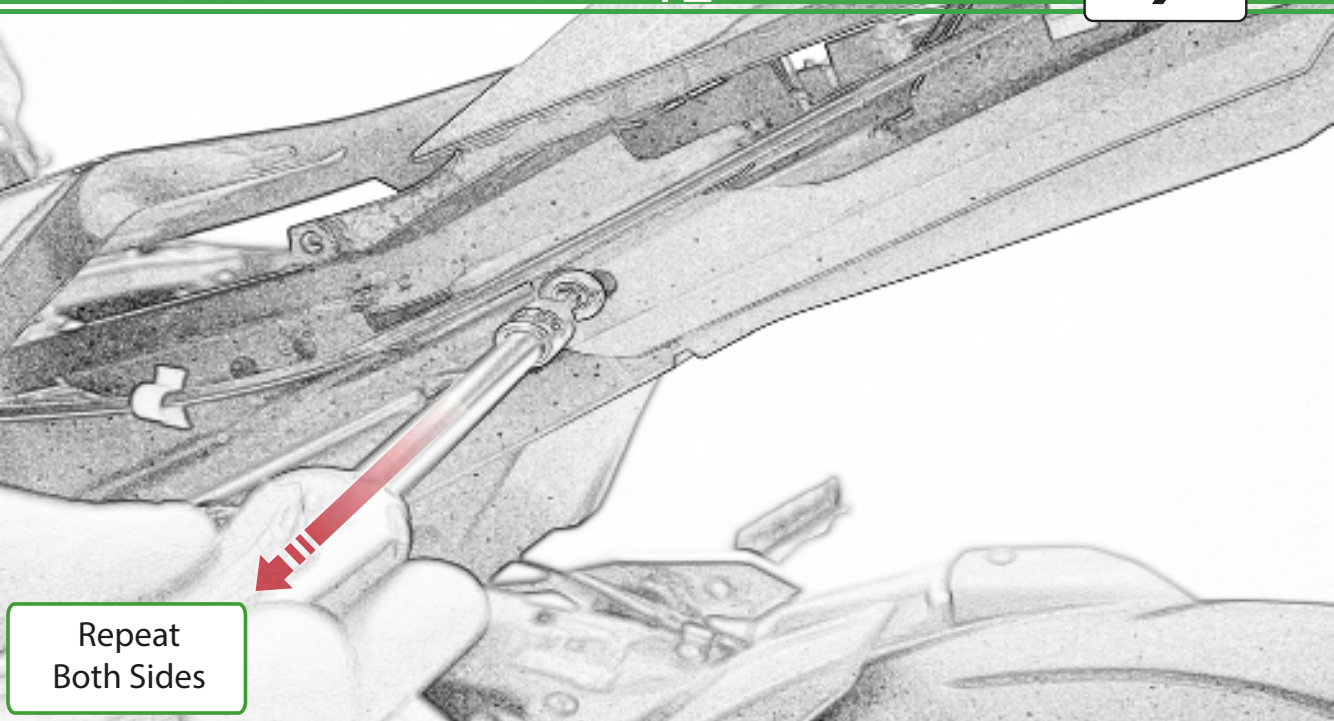

Repeat  
Both Sides

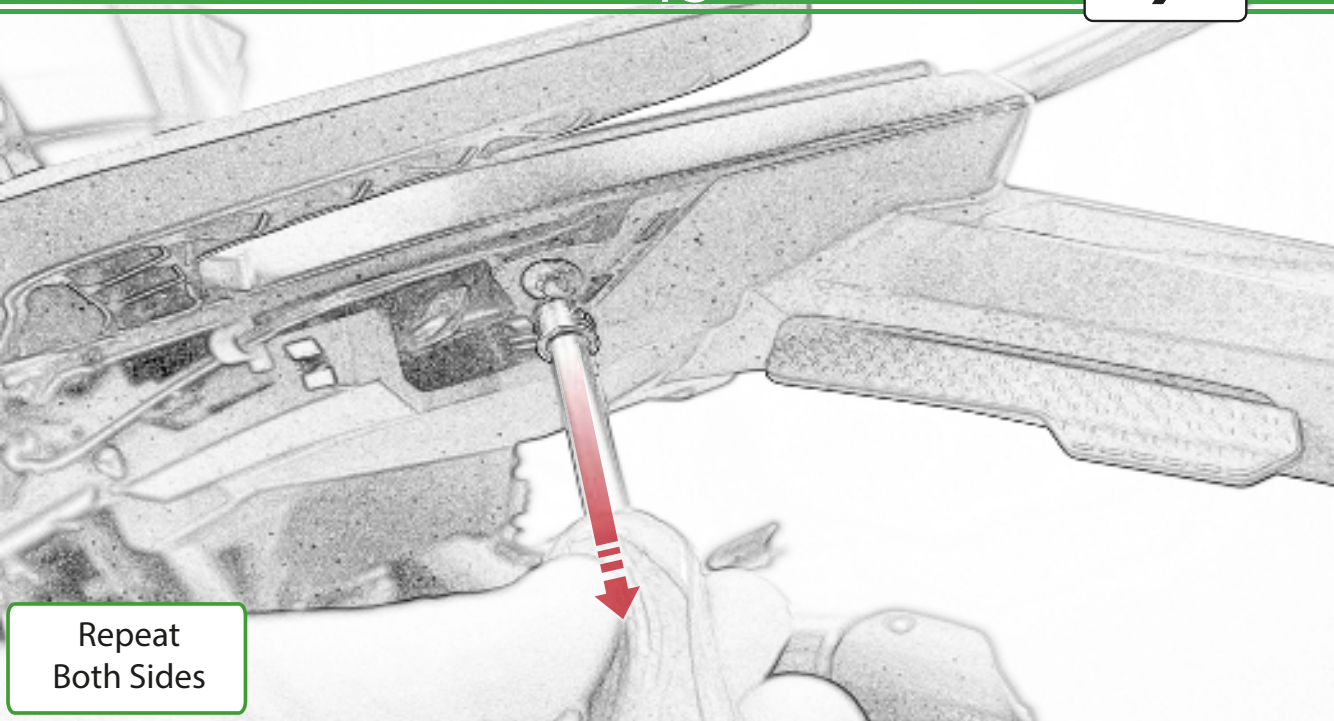

Repeat  
Both Sides

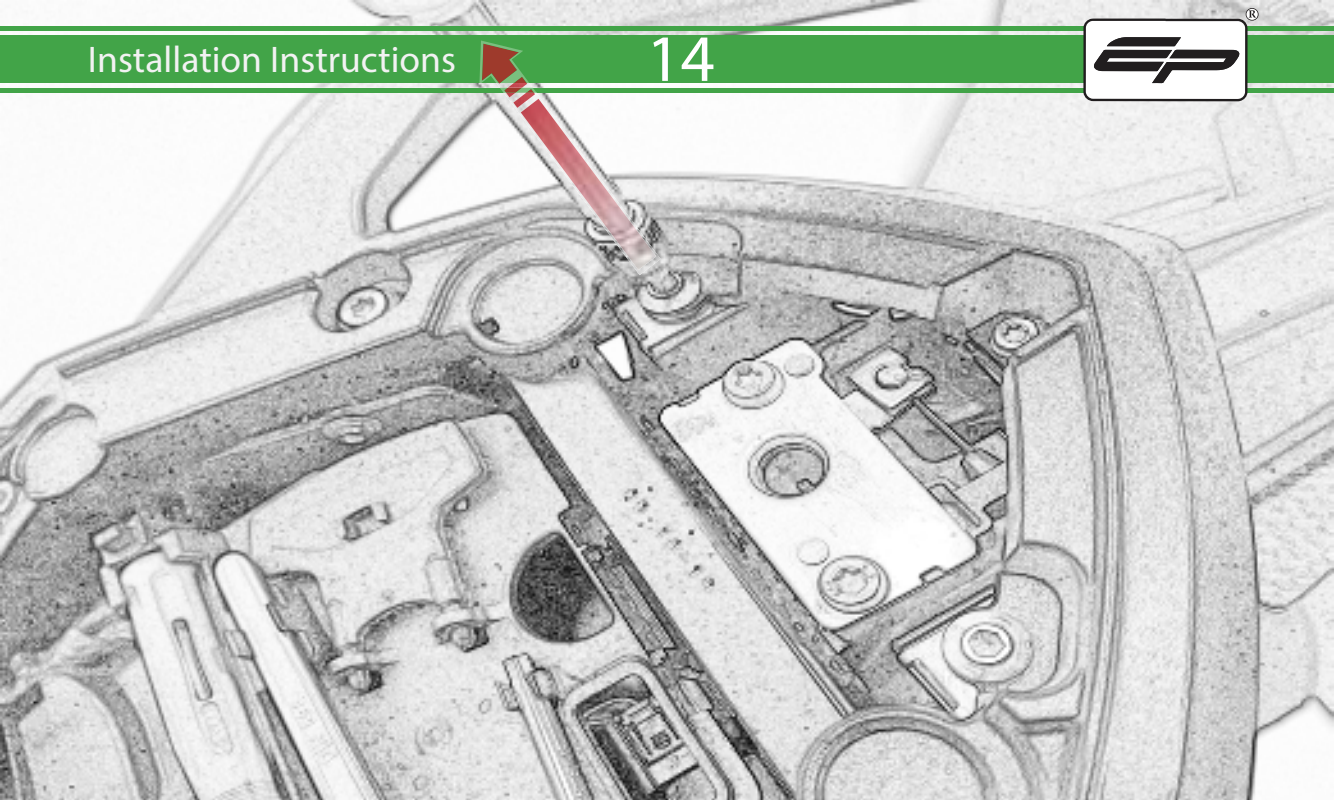



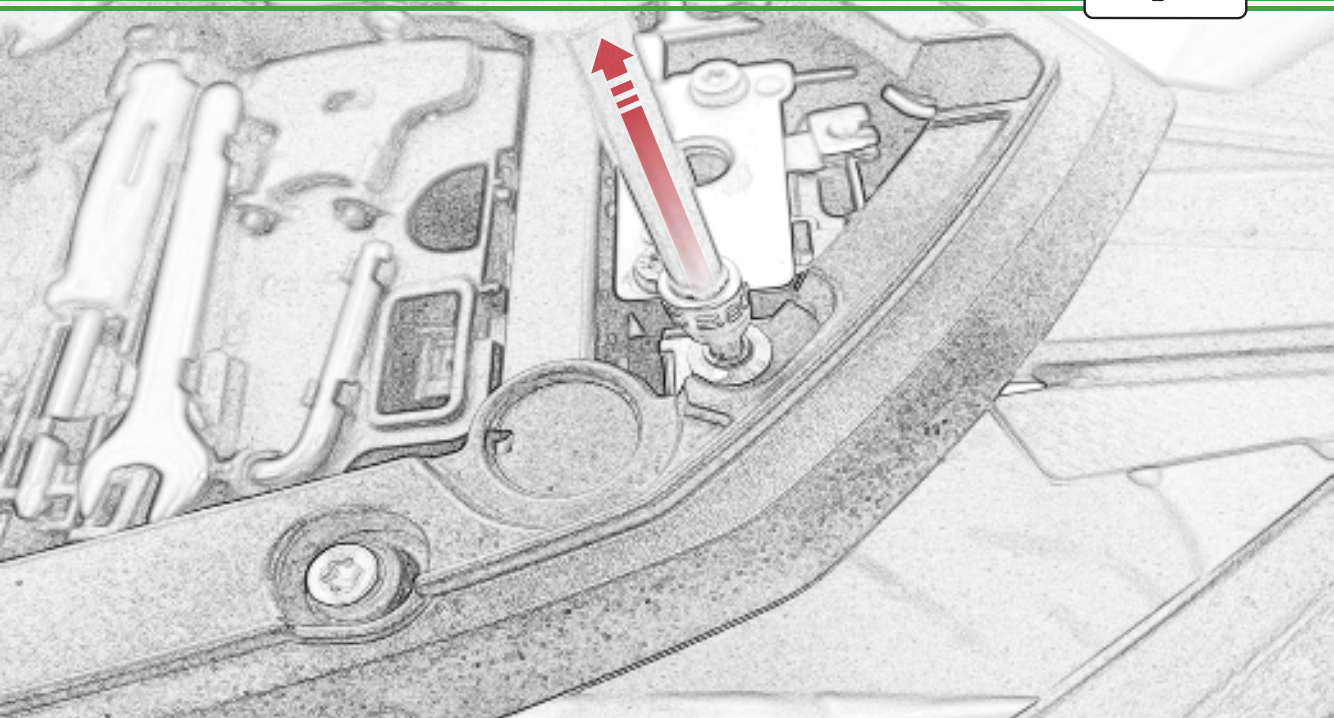

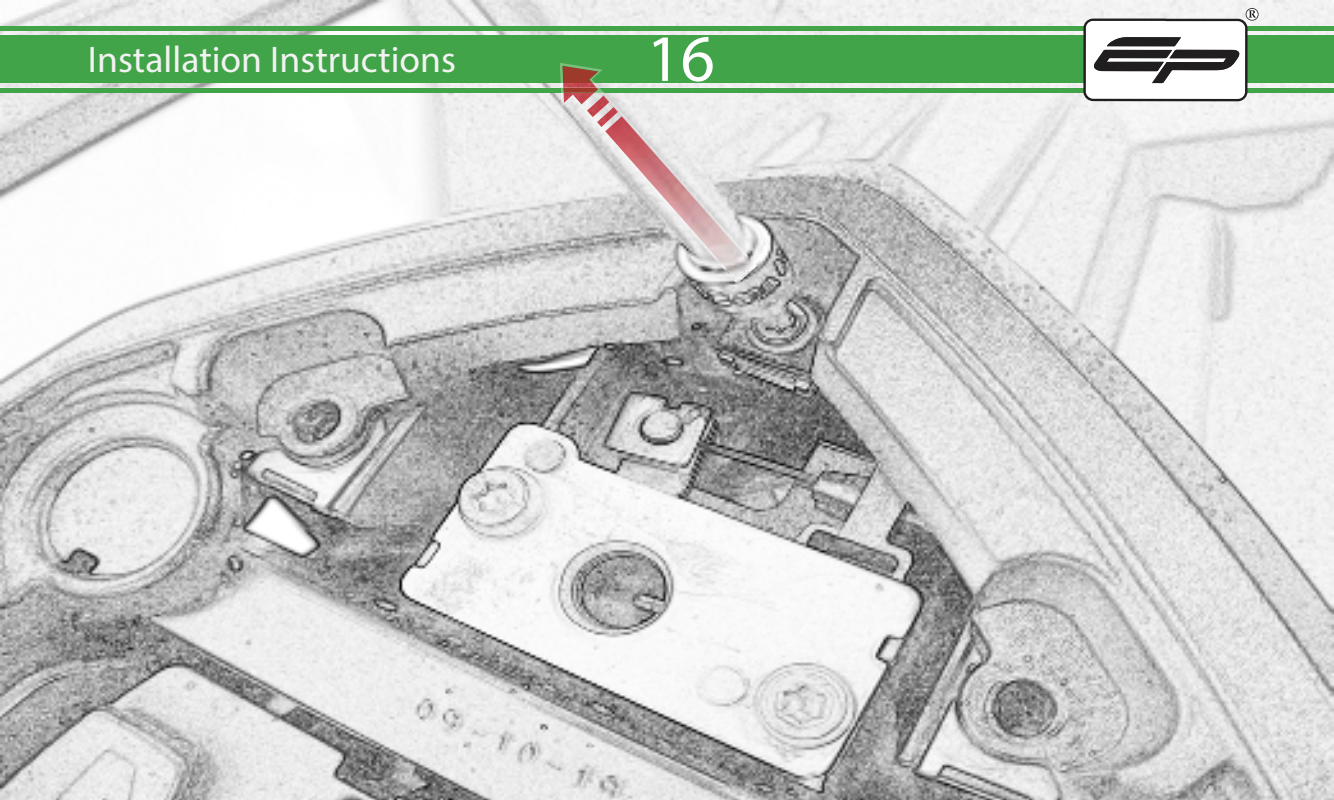



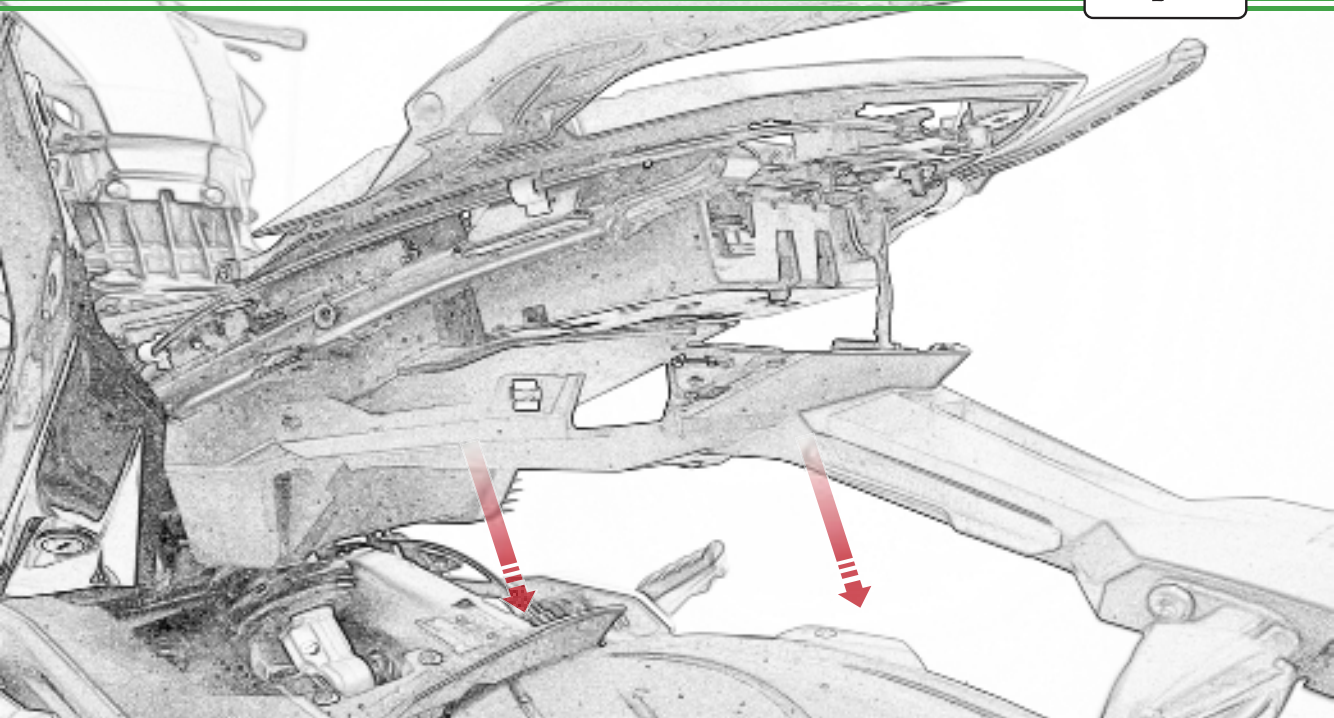

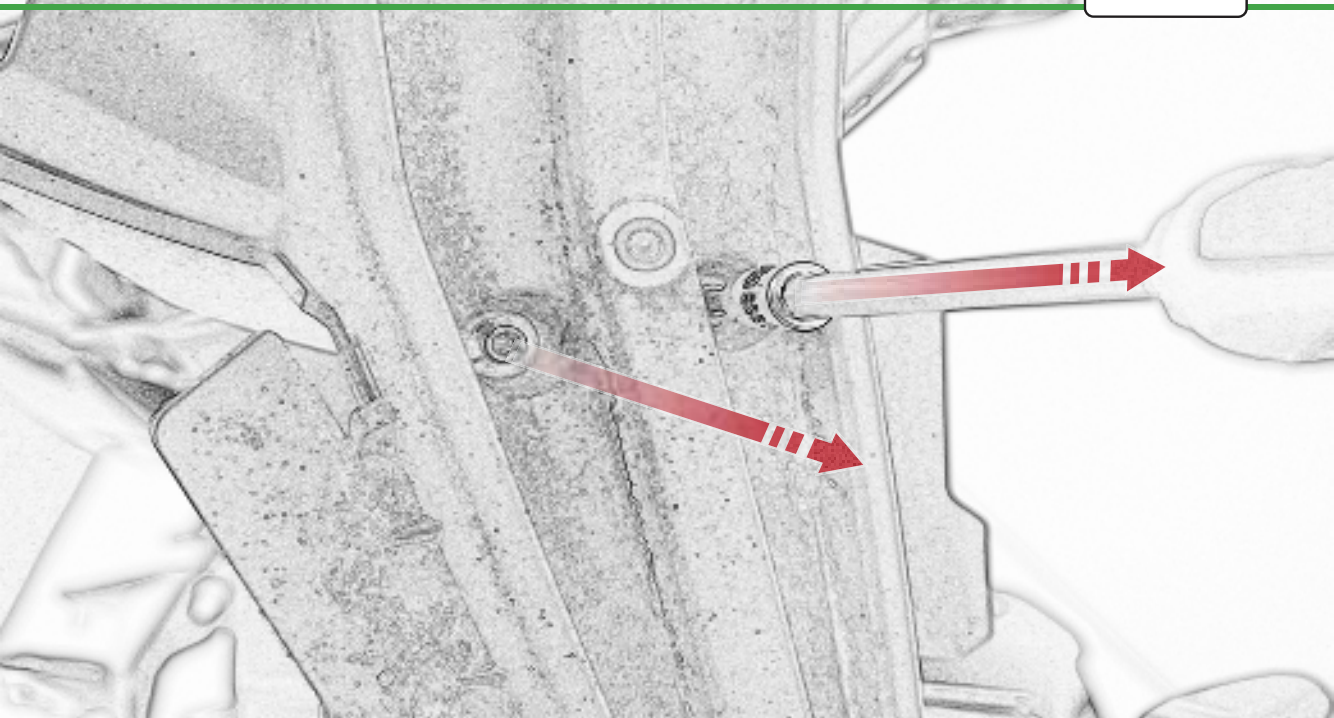

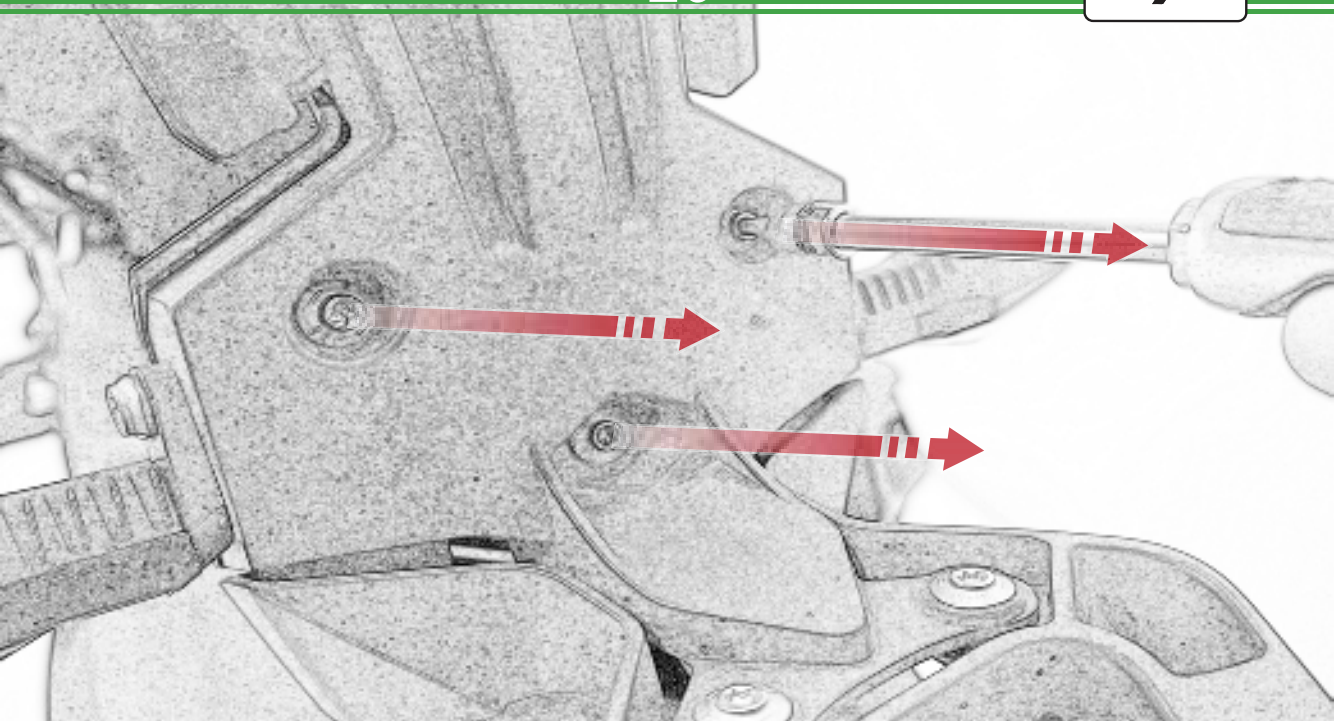

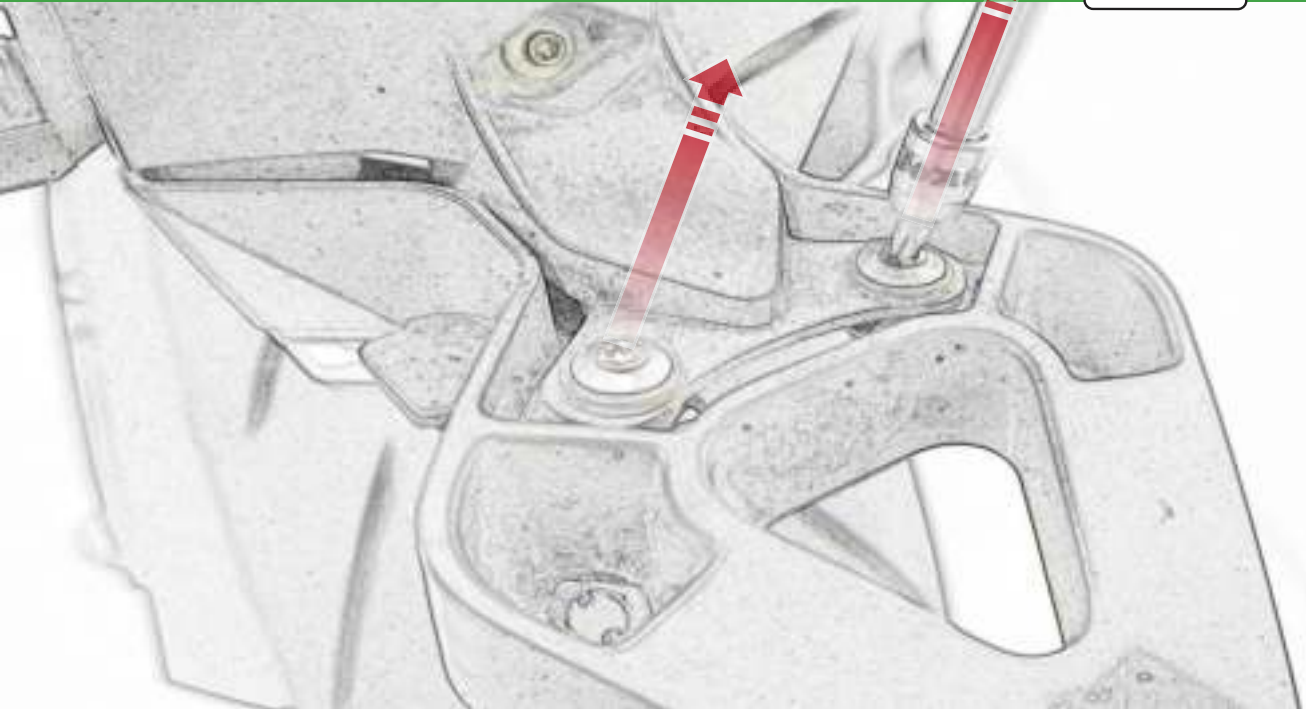

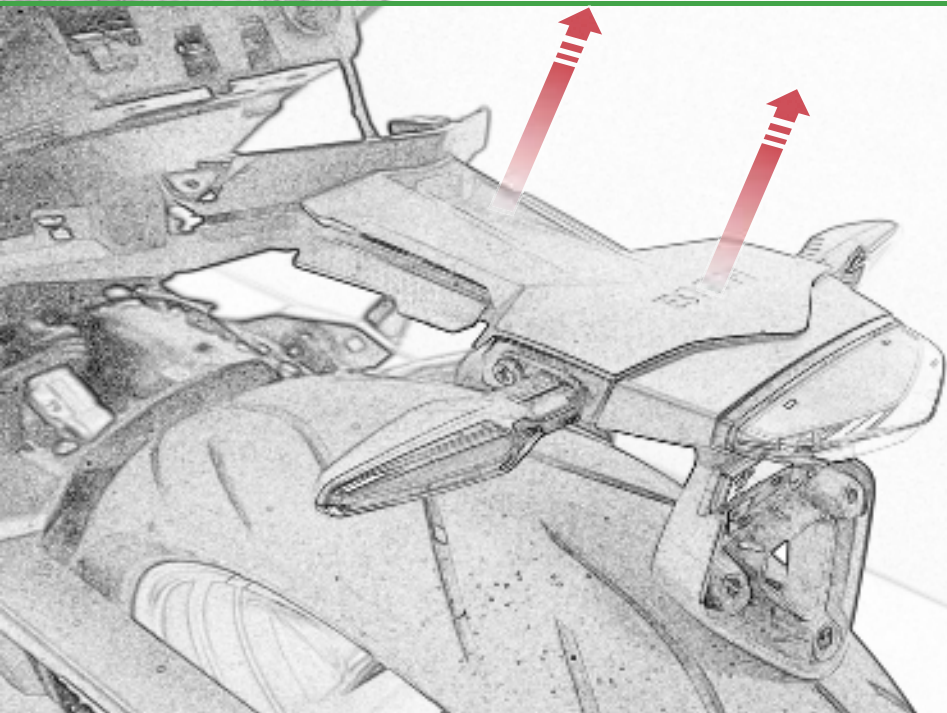



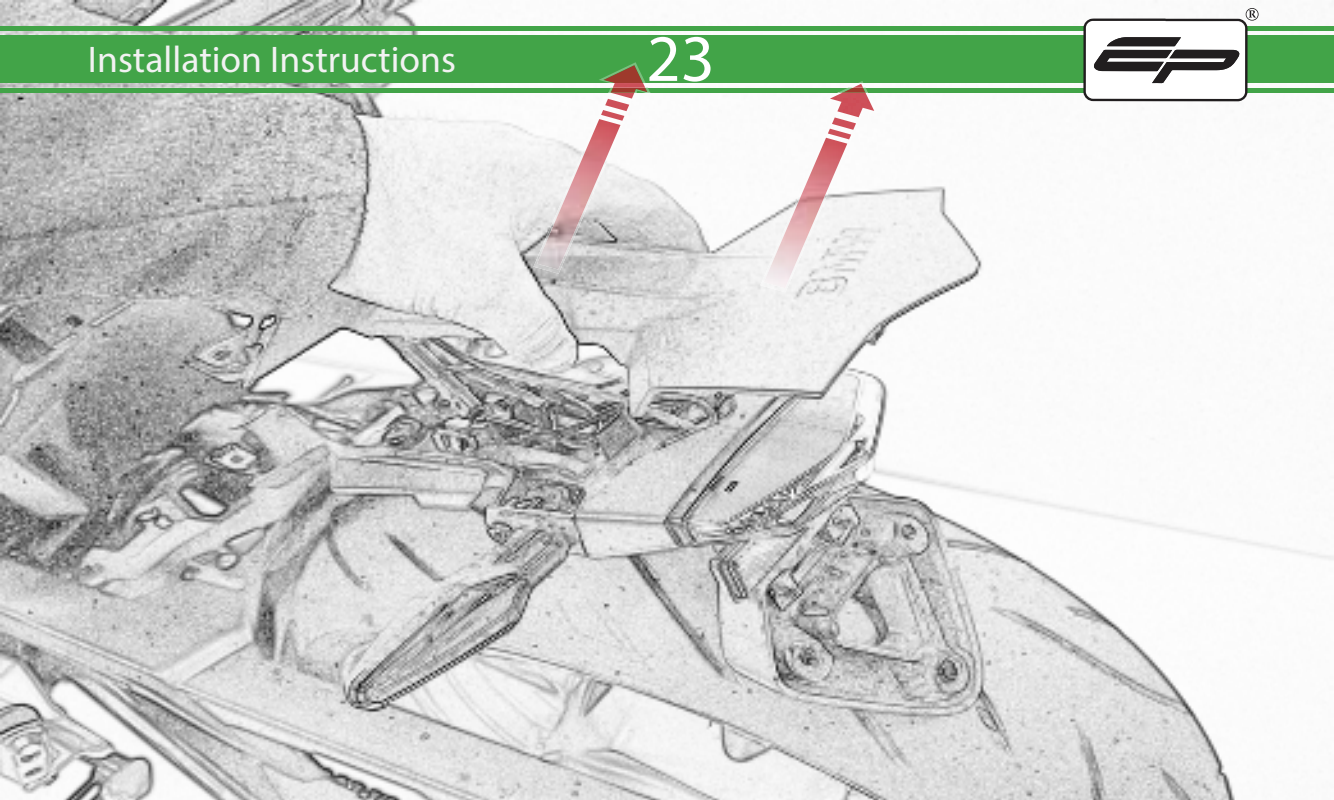

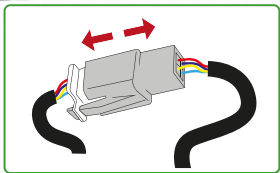
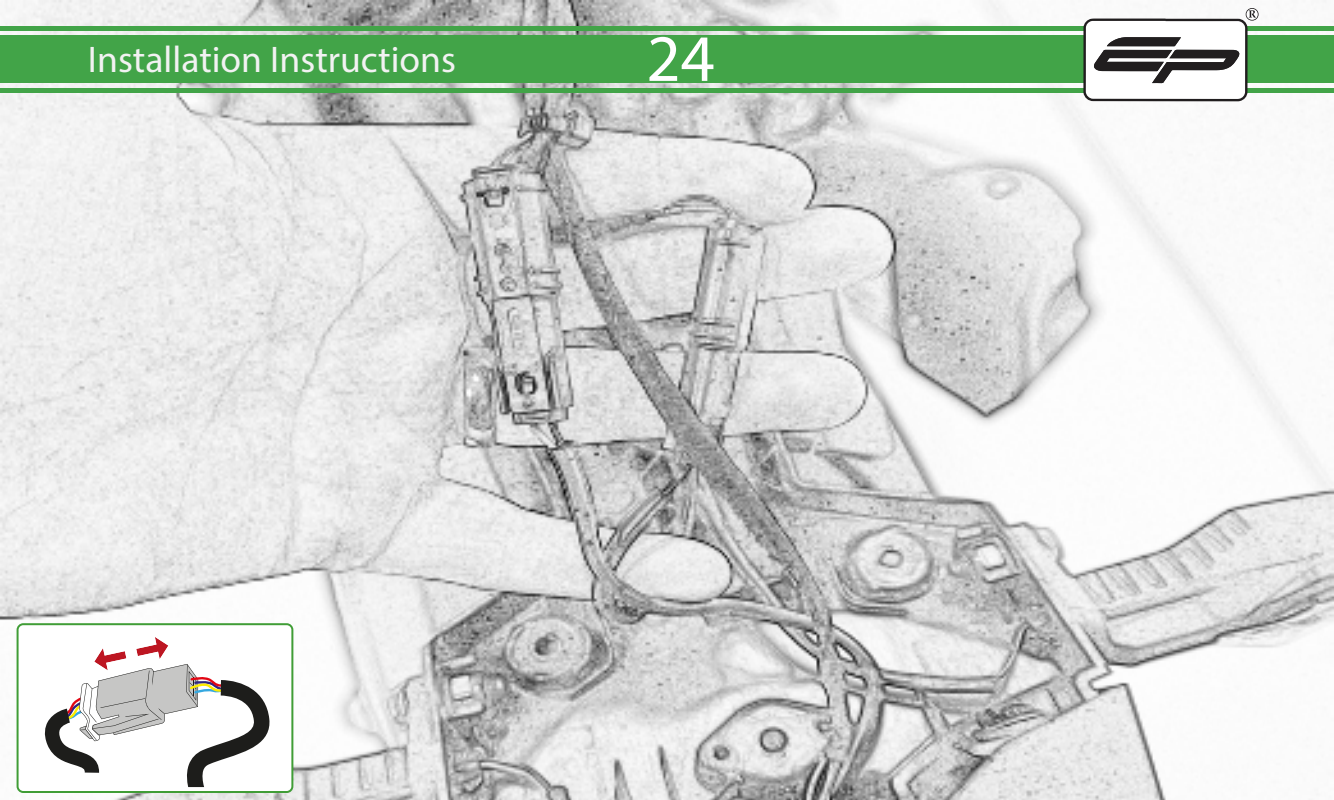

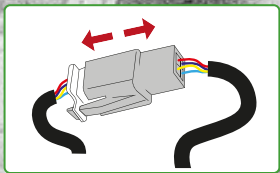
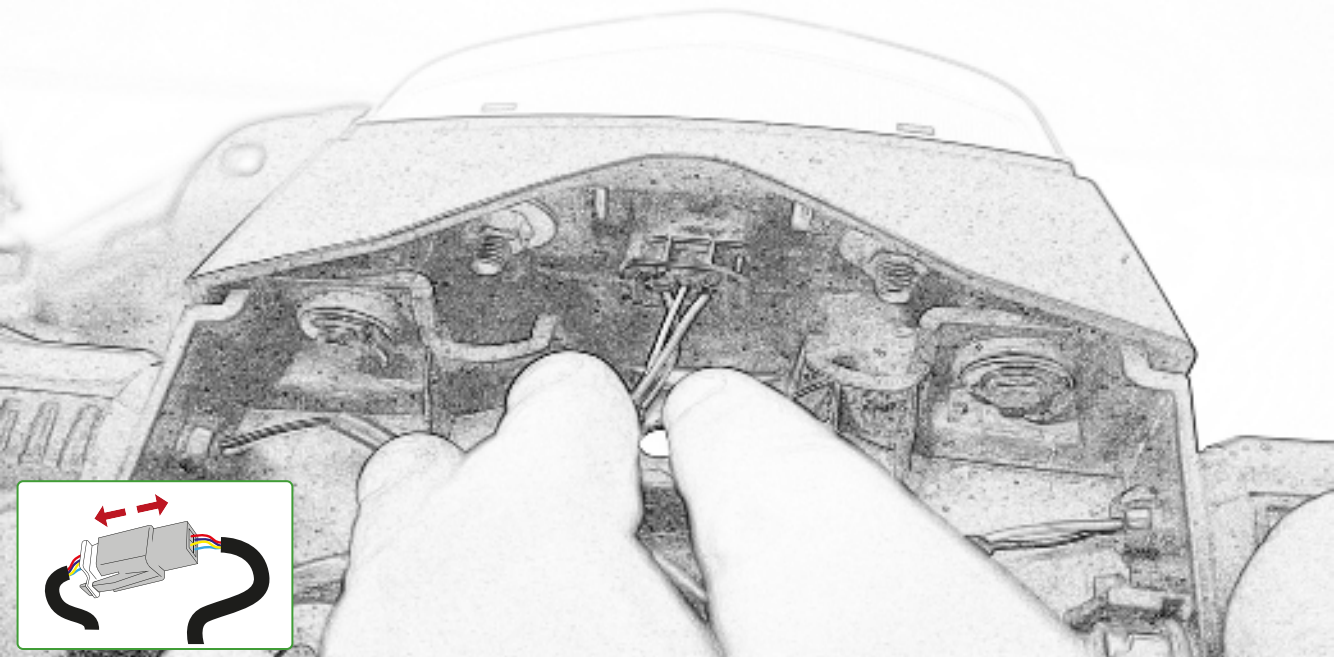

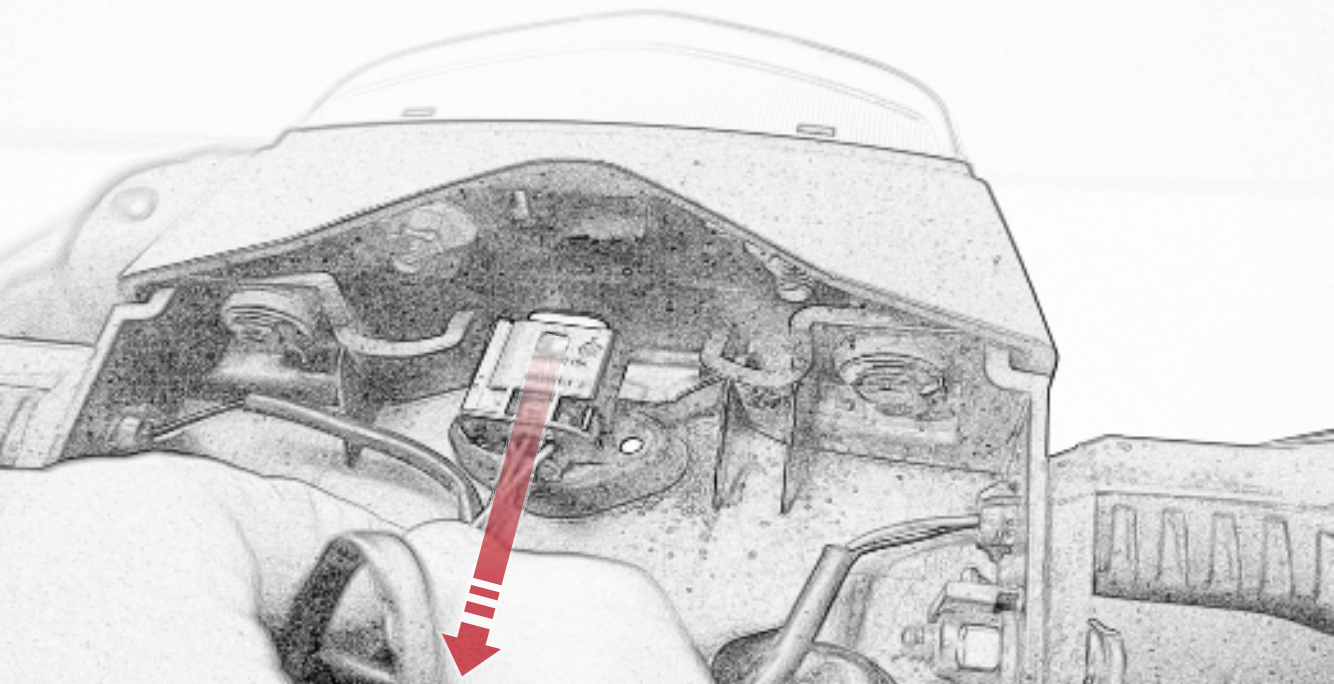

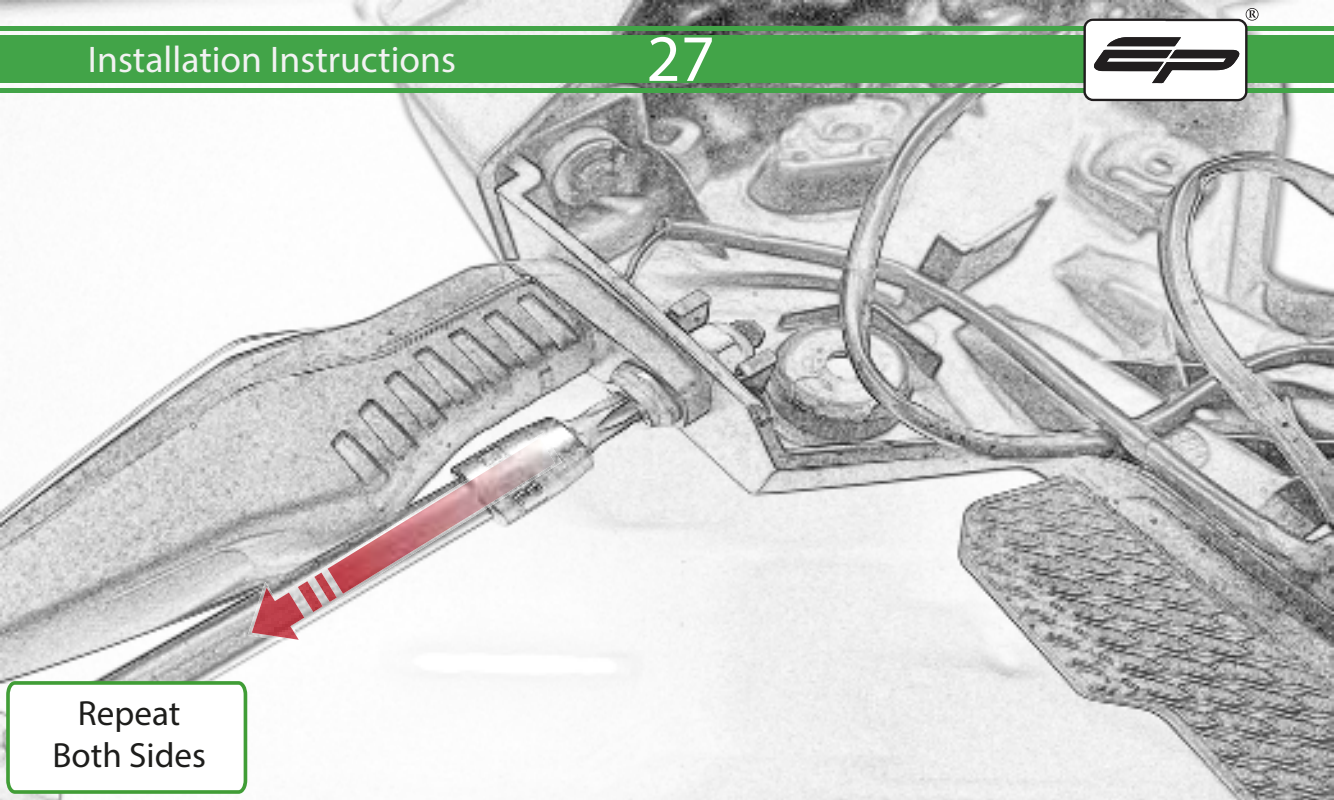

Repeat  
Both Sides

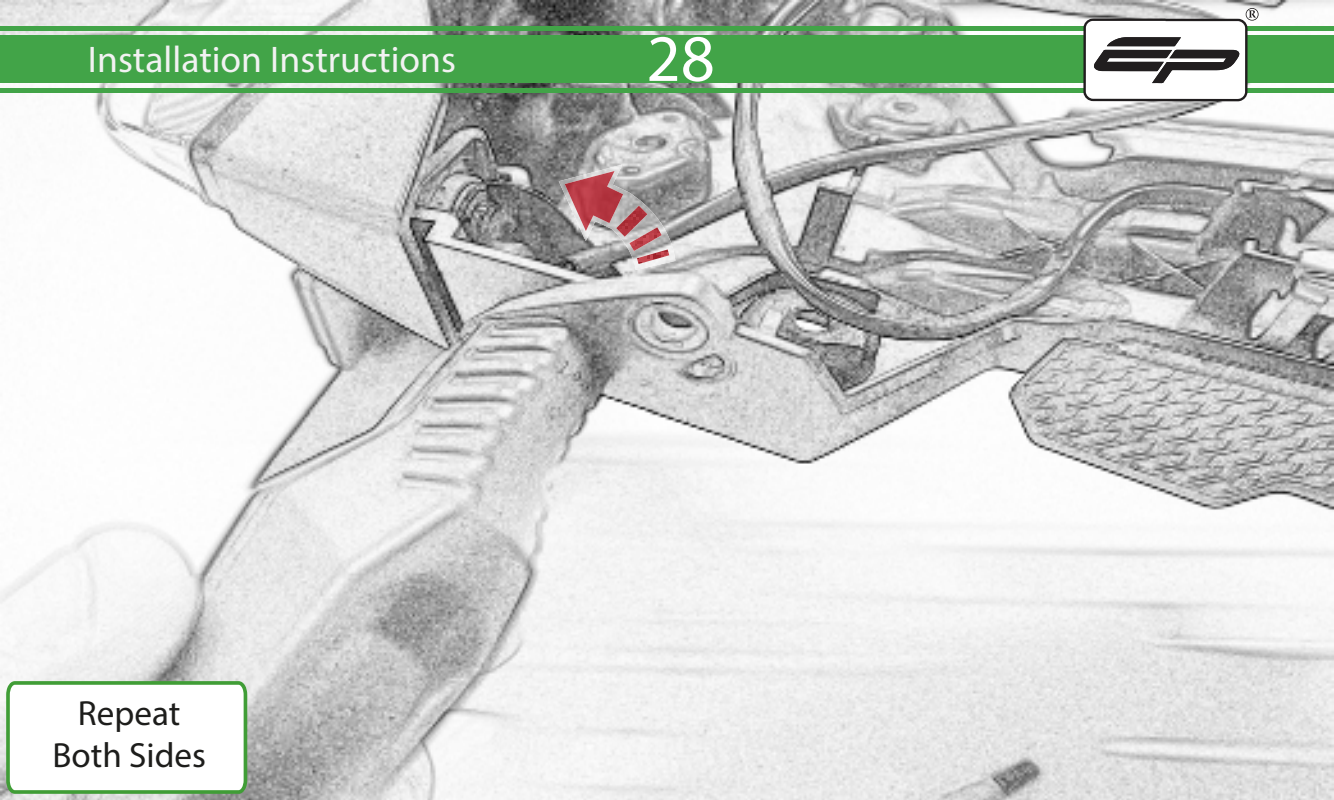

Repeat  
Both Sides

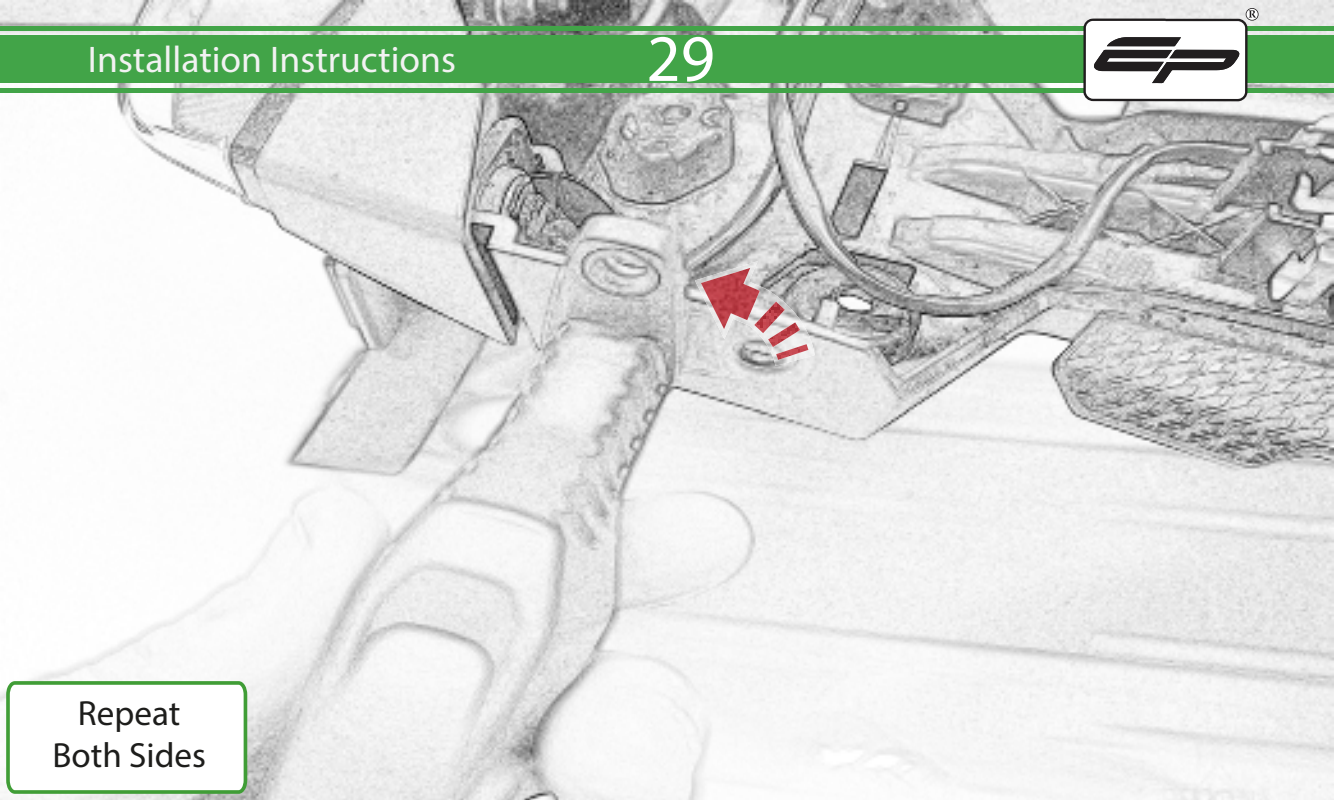

Repeat  
Both Sides

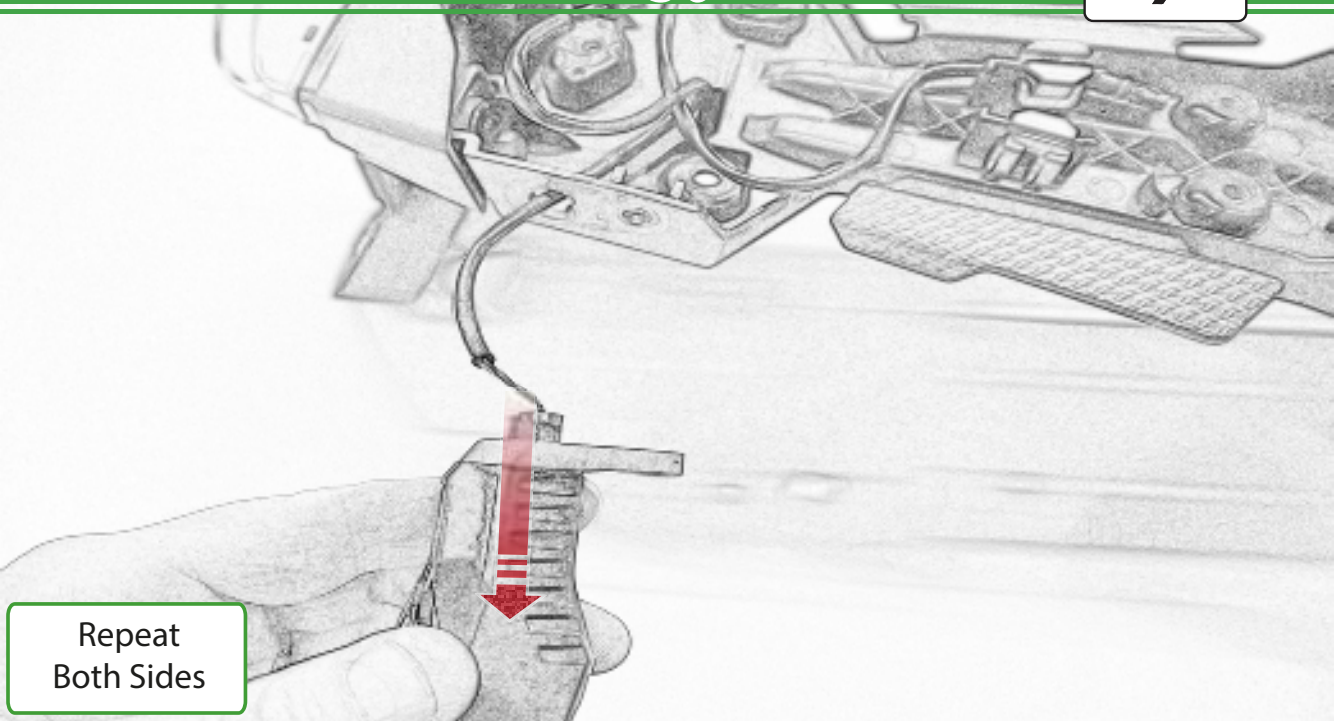

Repeat  
Both Sides



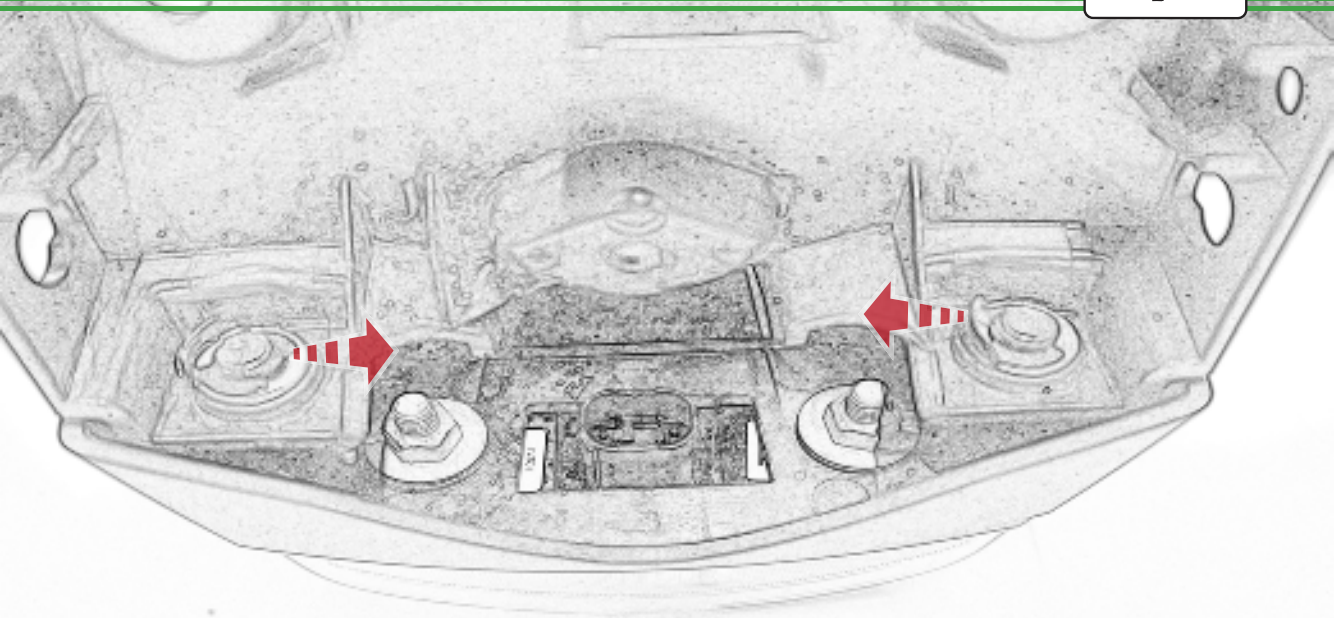

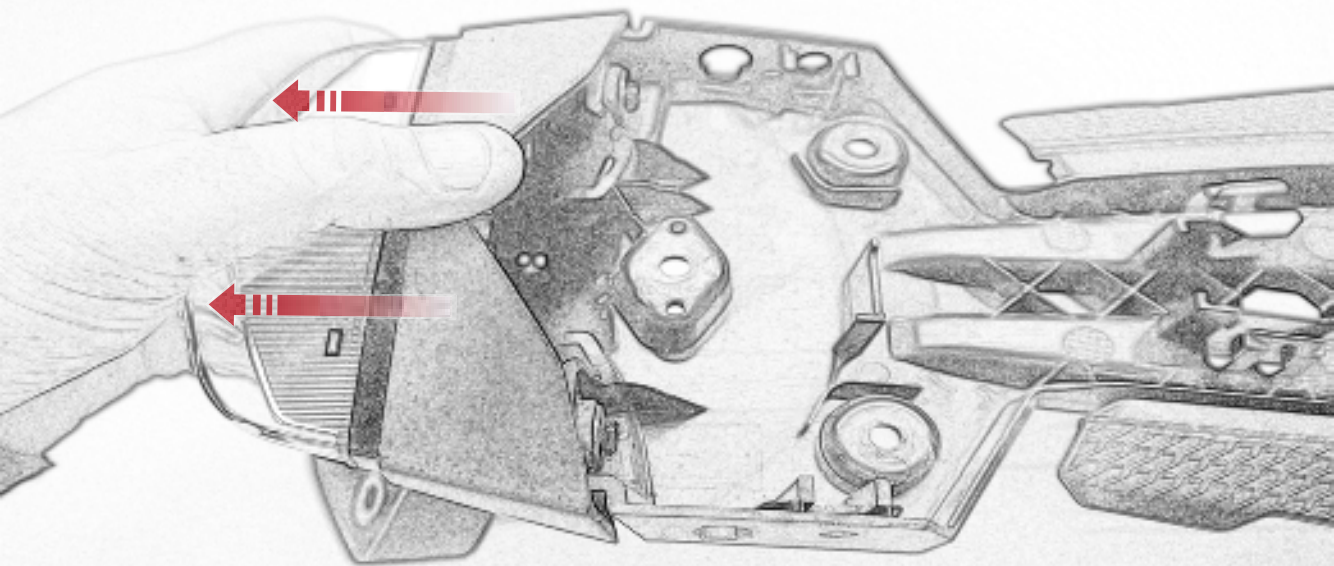

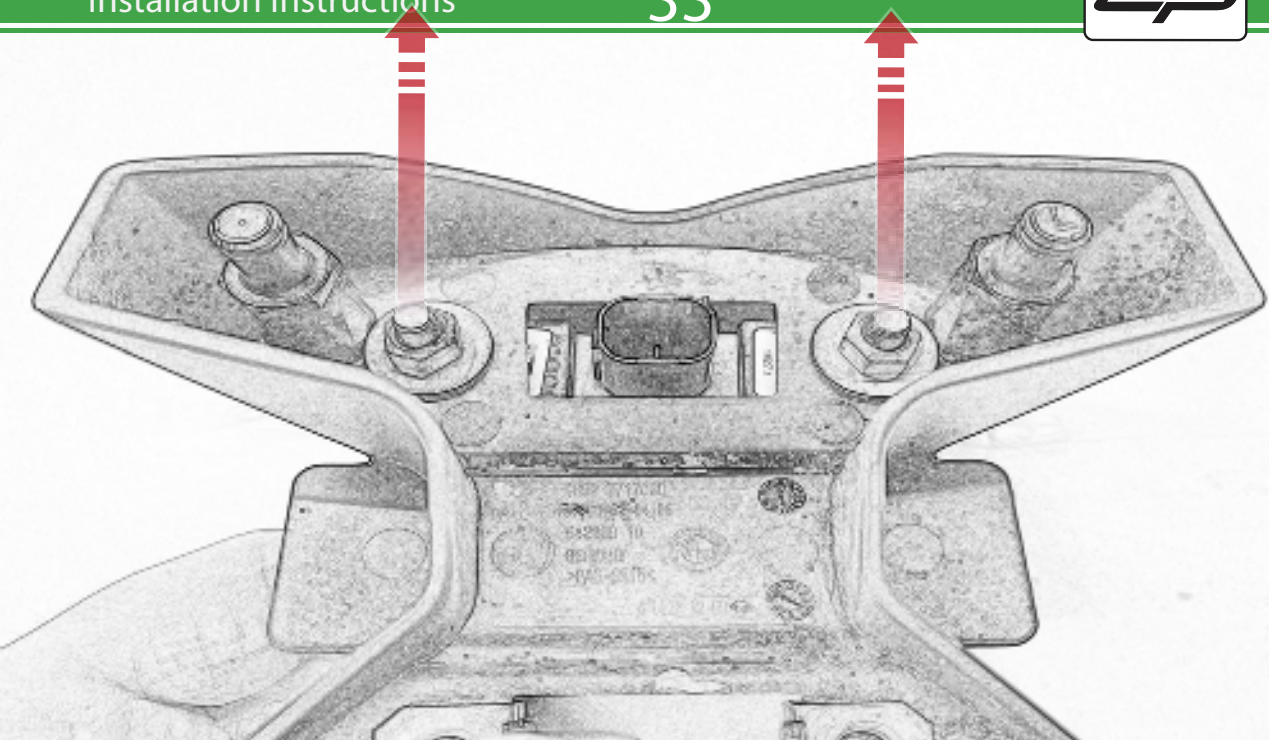

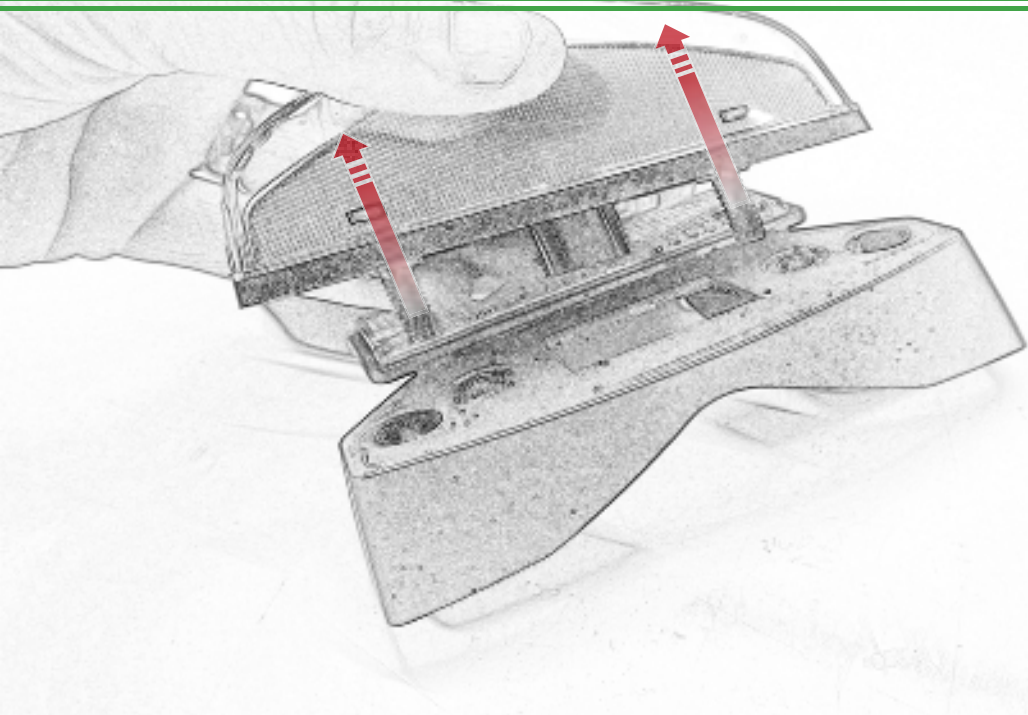

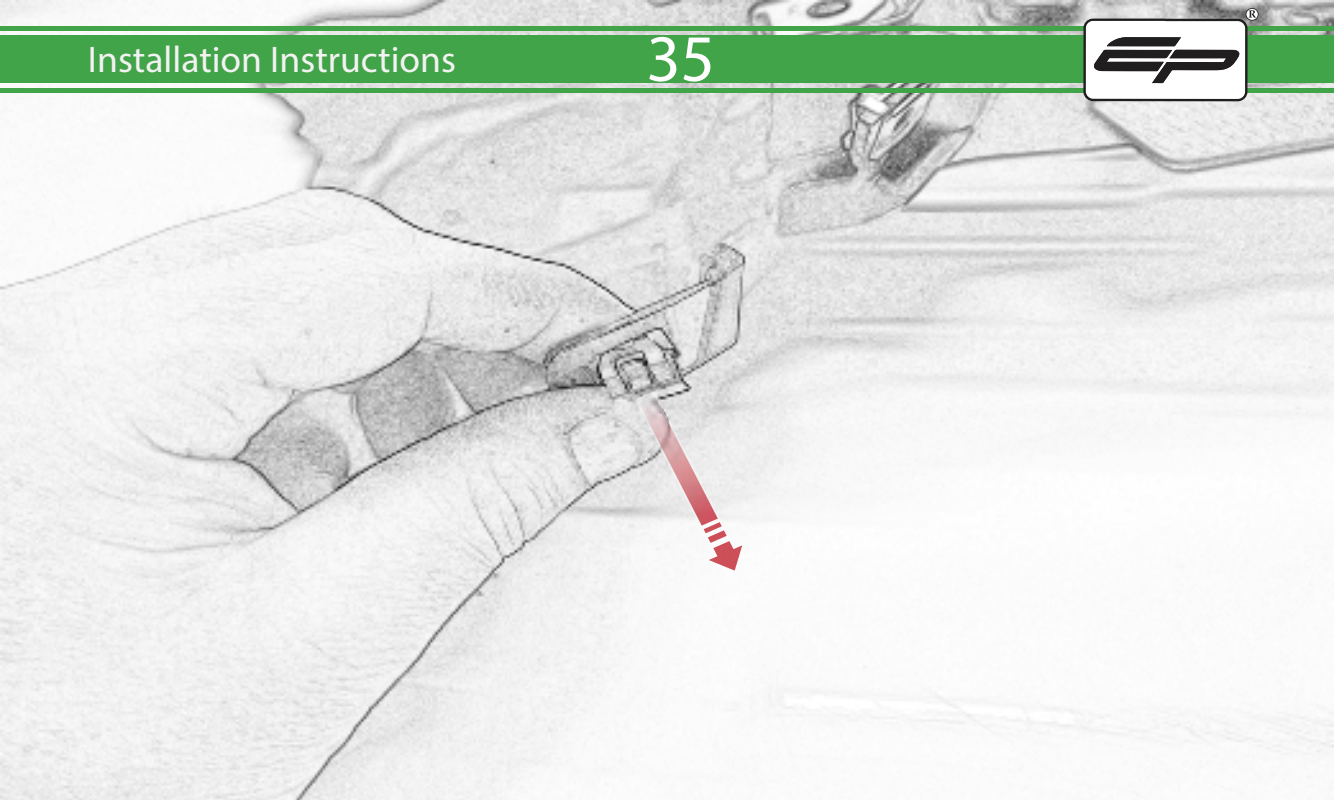

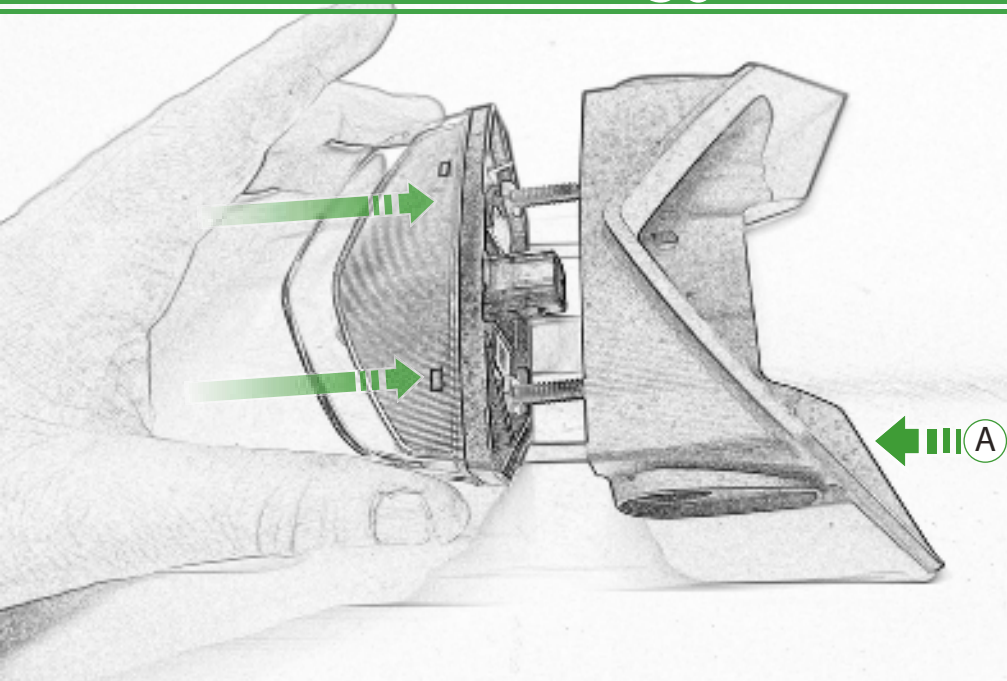

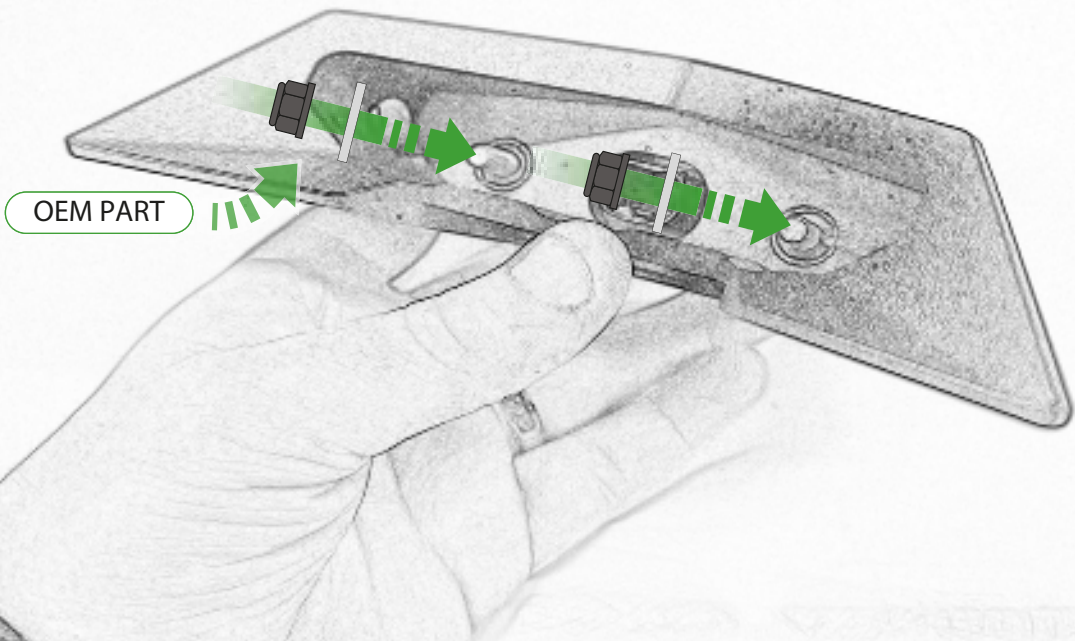

OEM PART

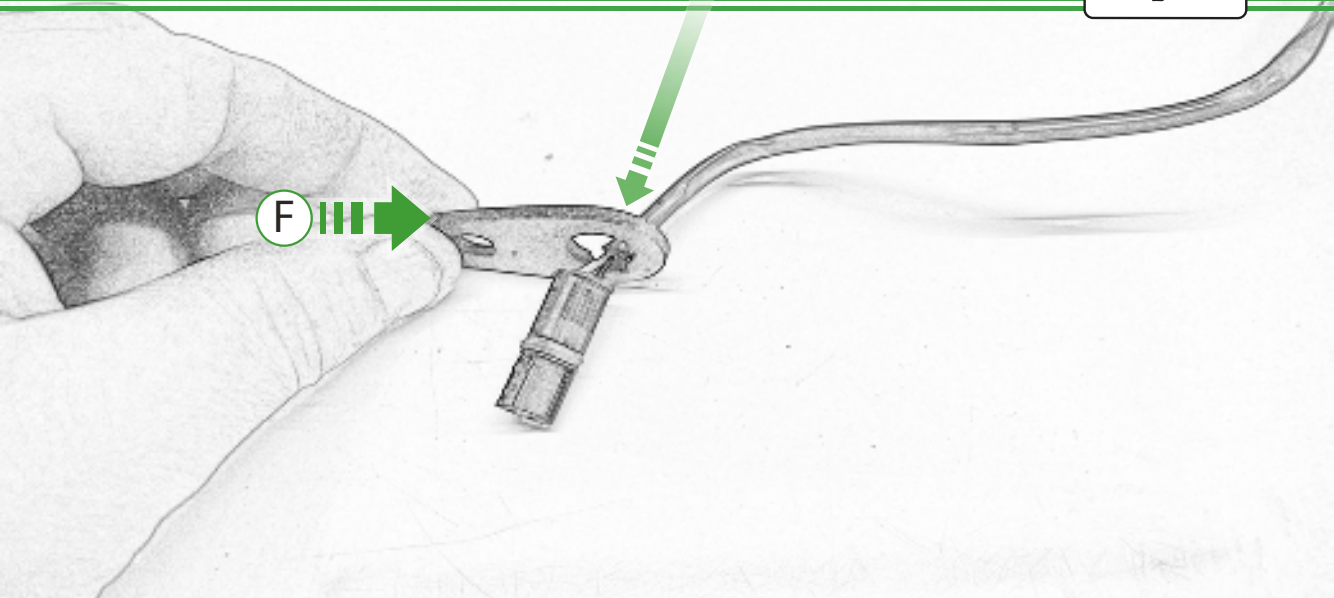

Repeat  
Both Sides



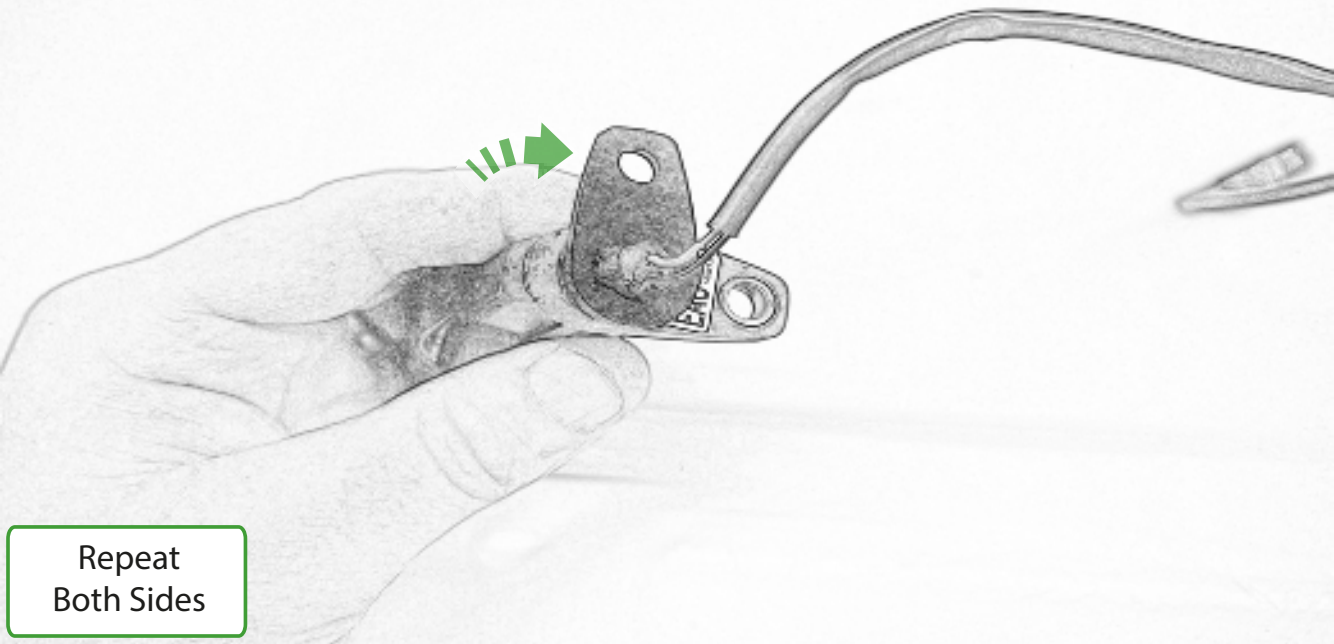

Repeat  
Both Sides

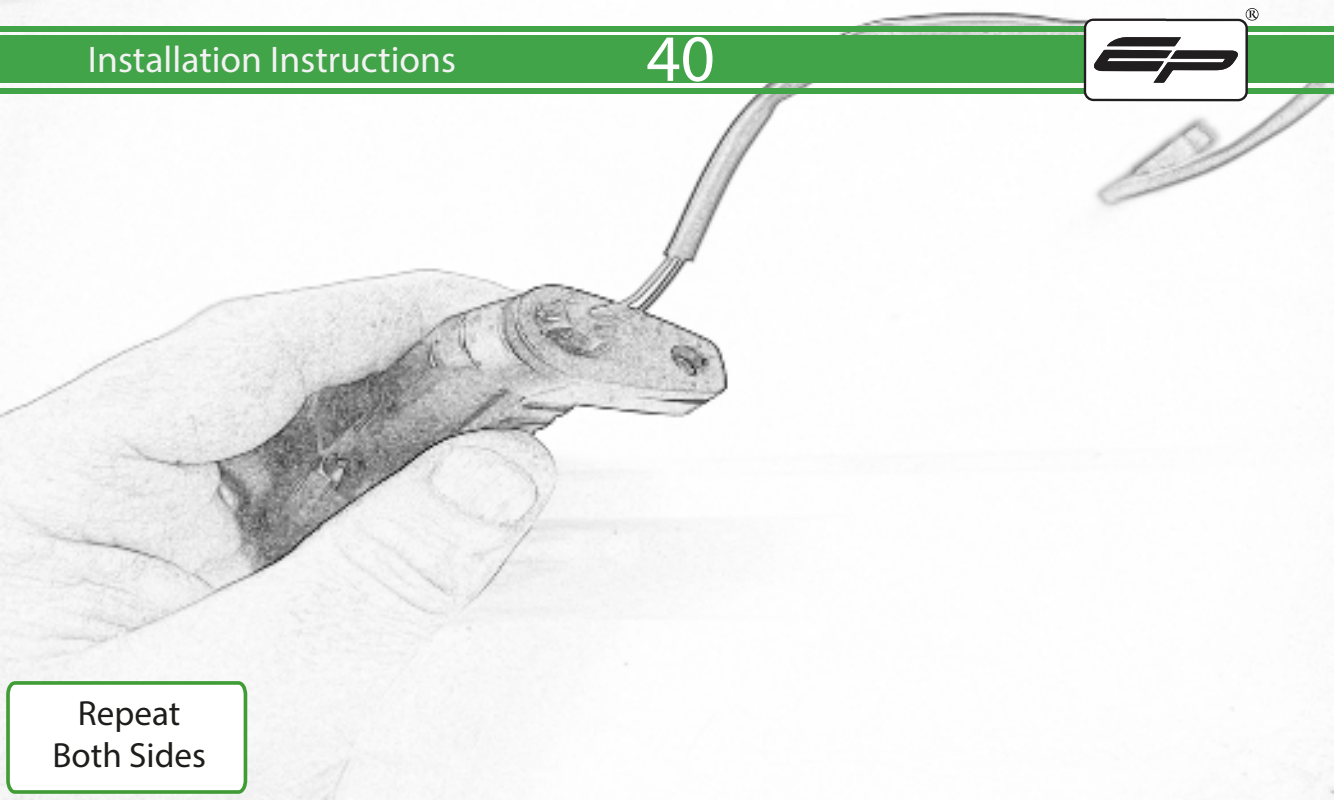

Repeat  
Both Sides

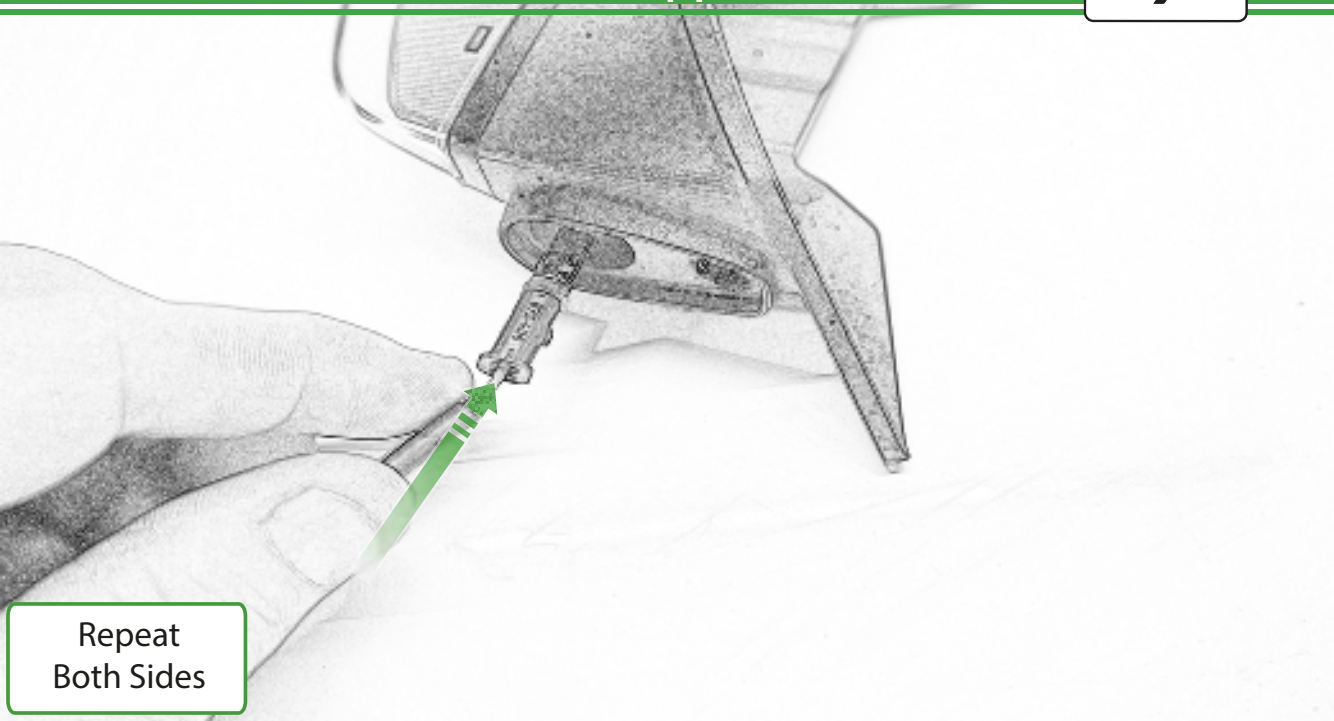

Repeat  
Both Sides

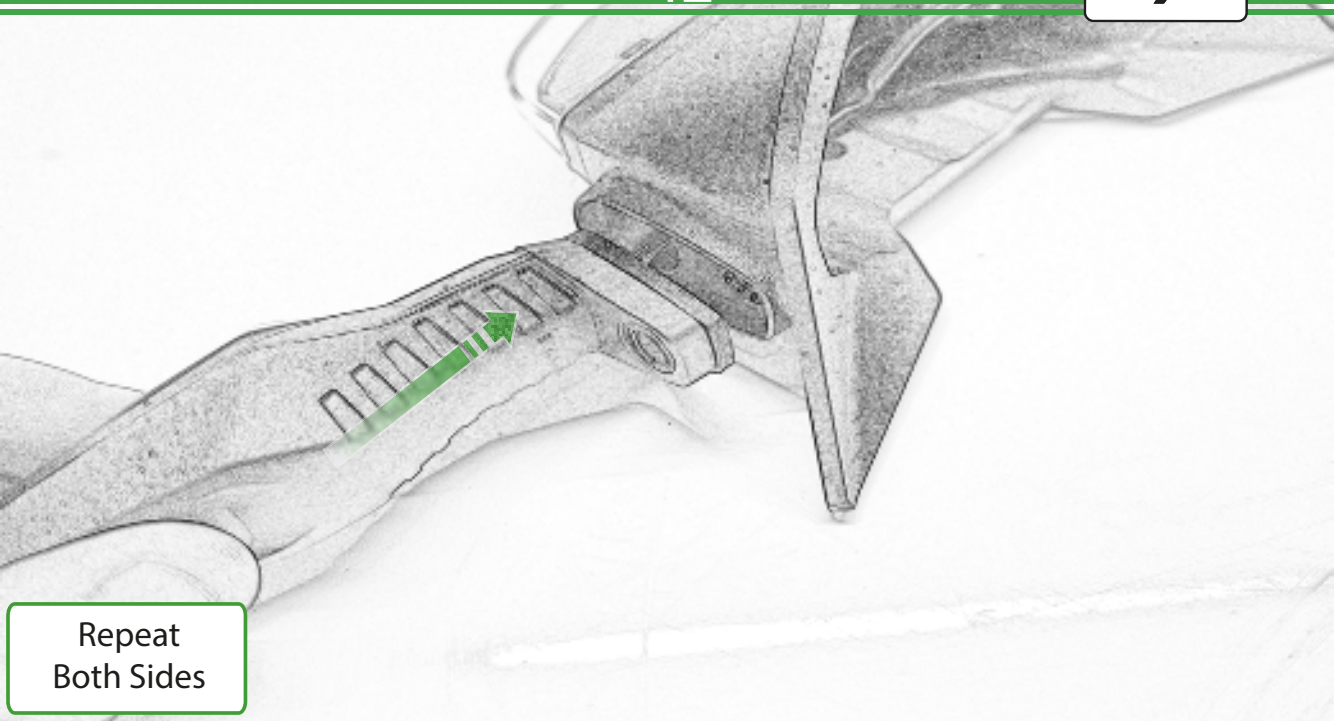

Repeat  
Both Sides

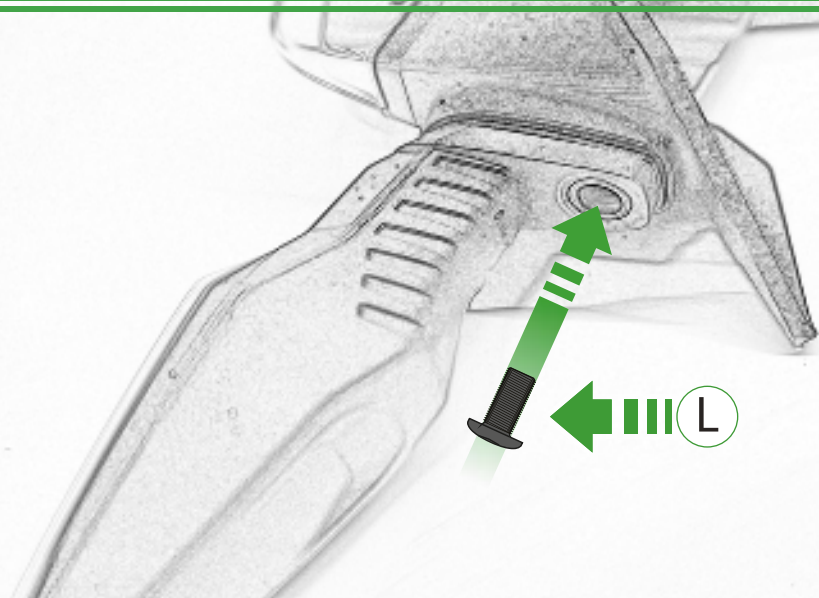

Repeat  
Both Sides

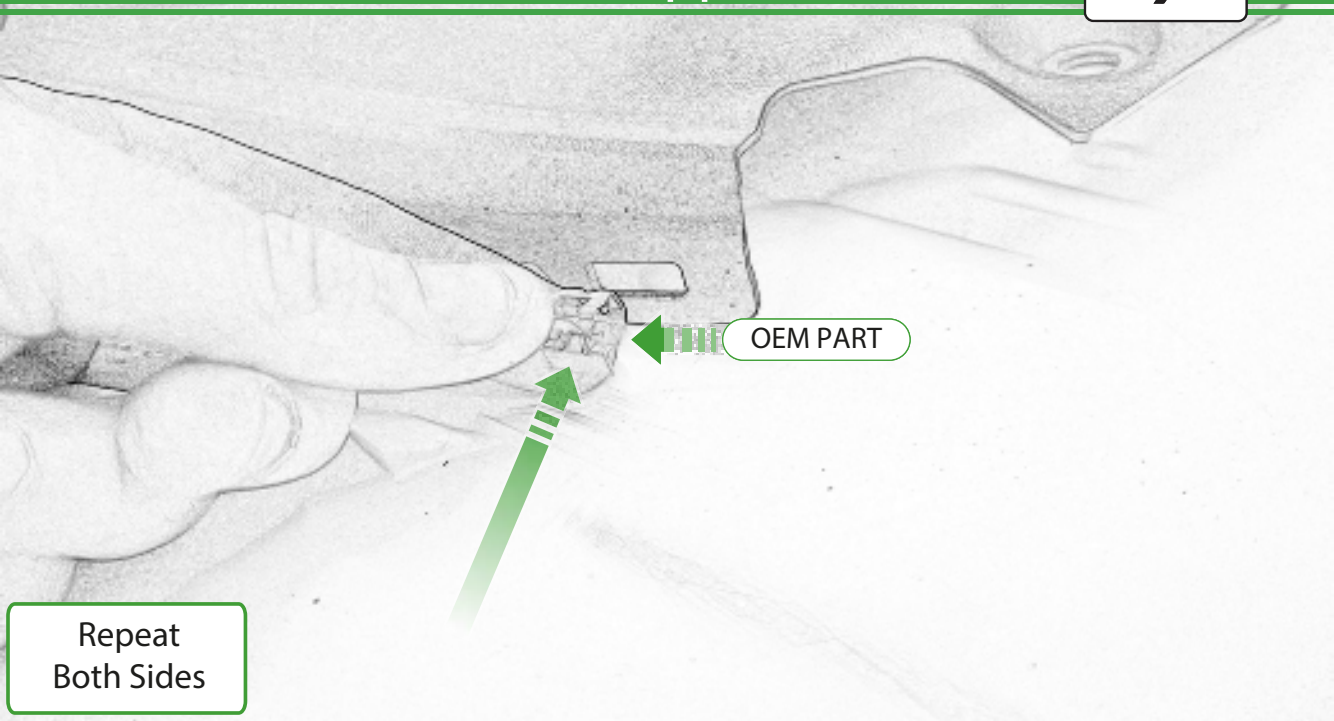

OEM PART

Repeat  
Both Sides

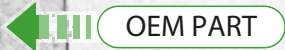
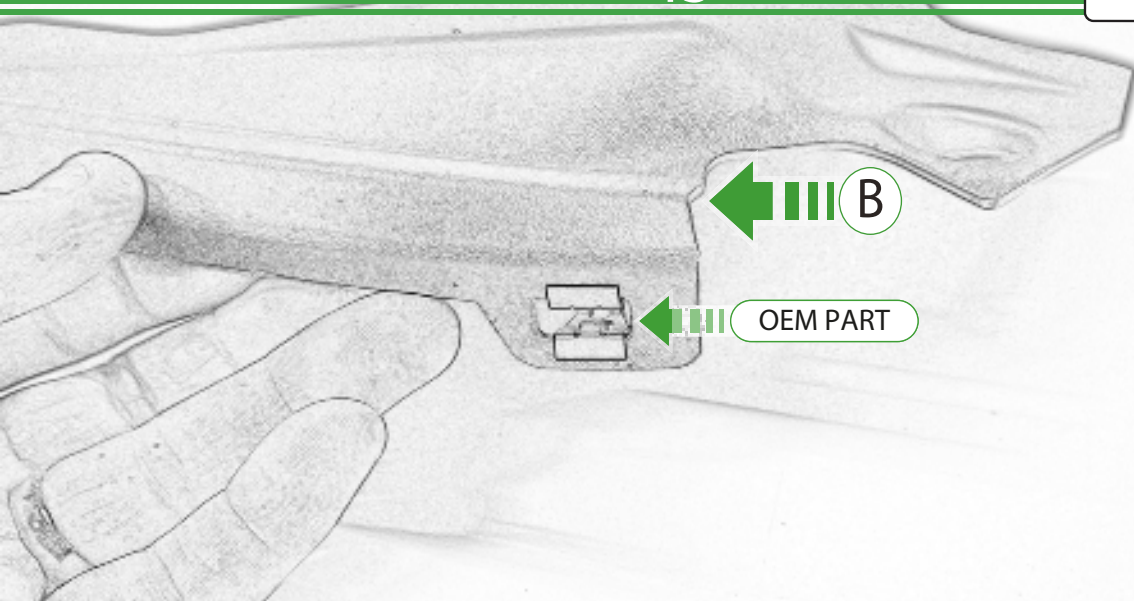

Repeat  
Both Sides

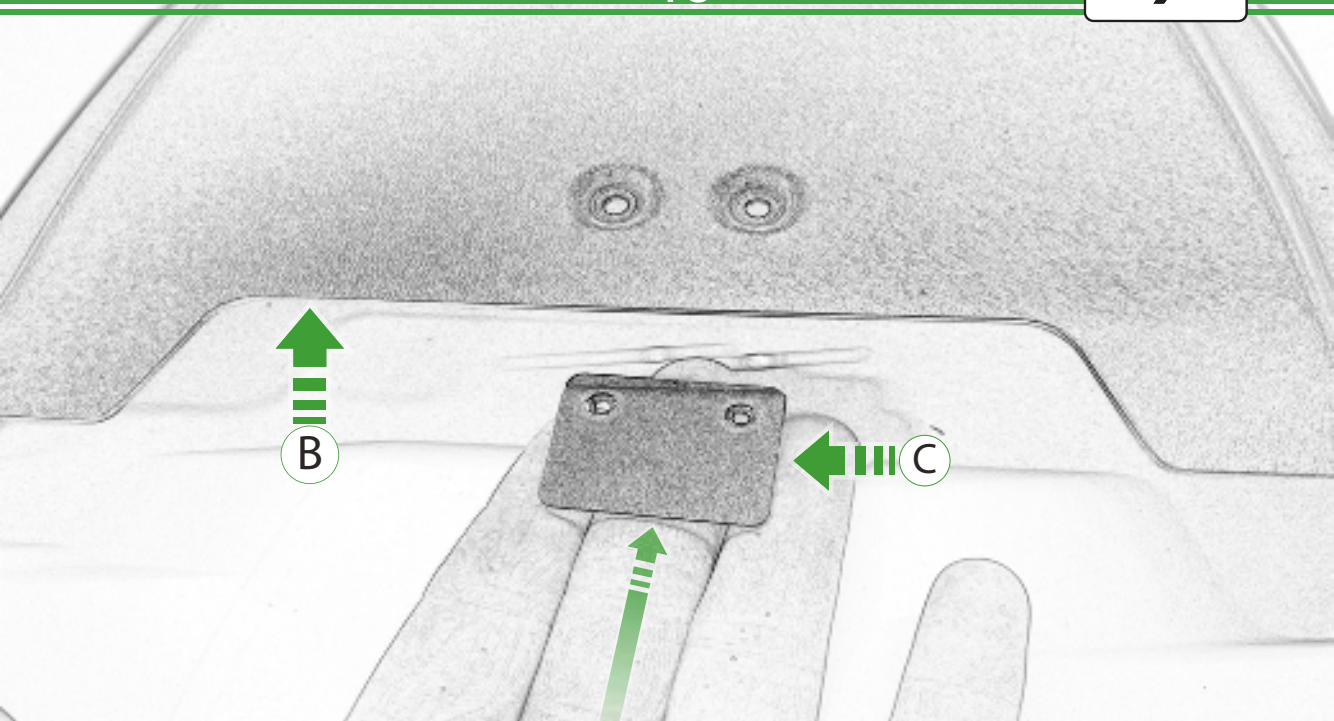



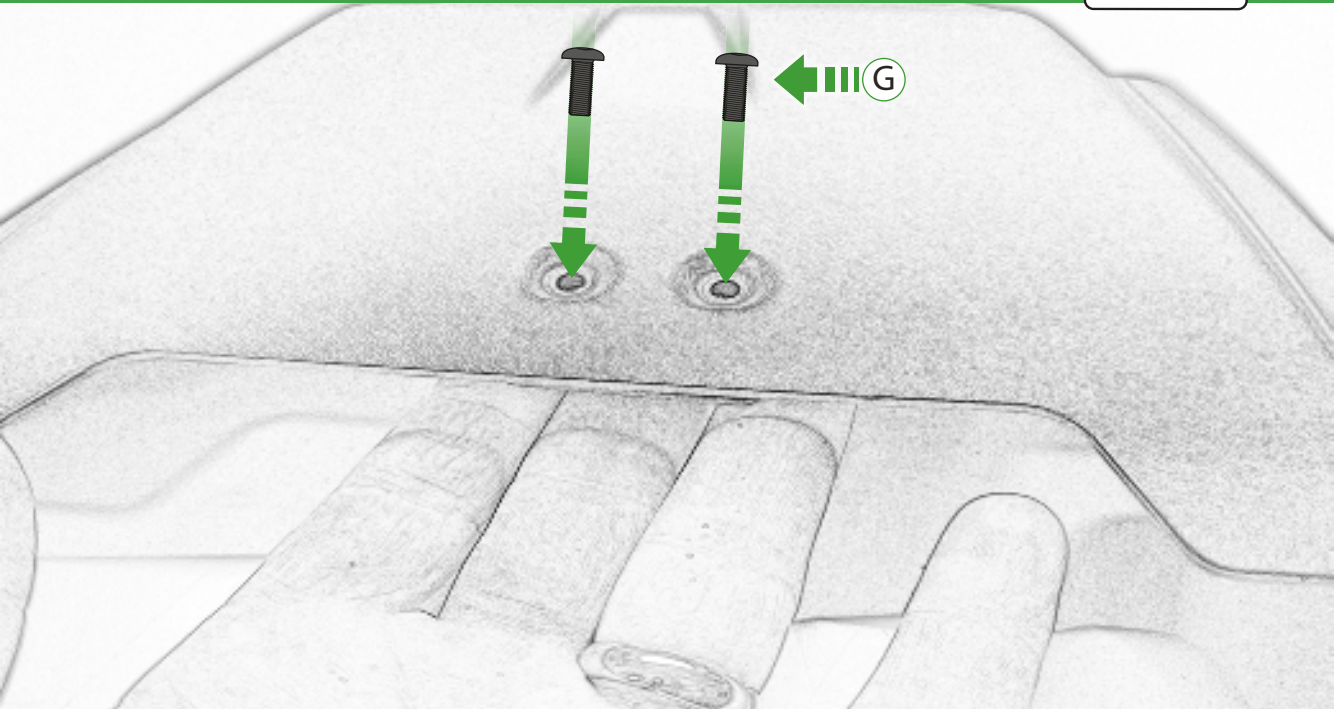

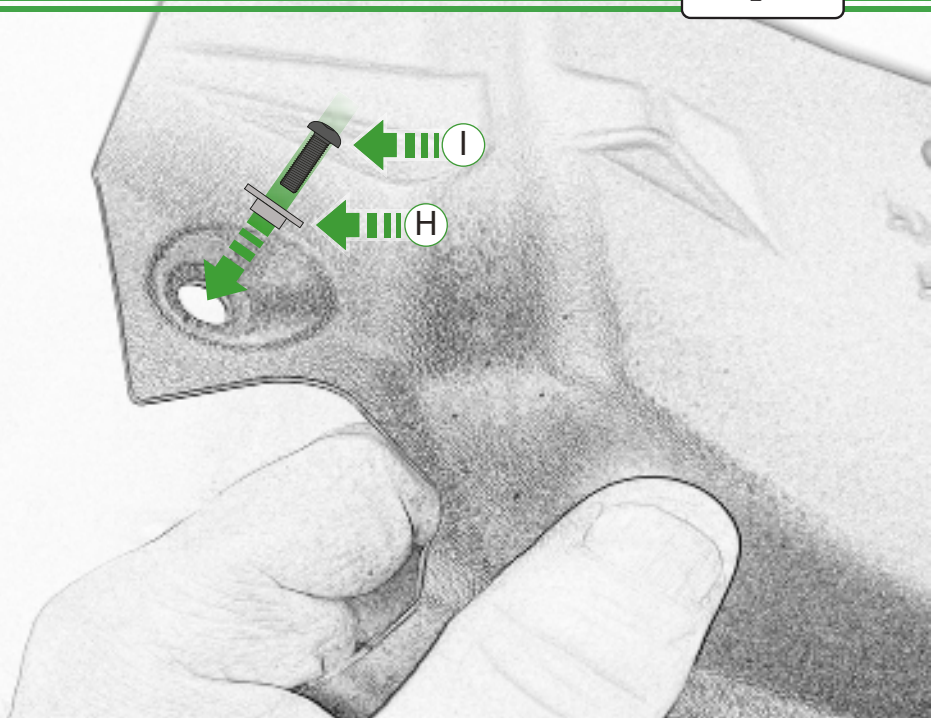

Repeat  
Both Sides

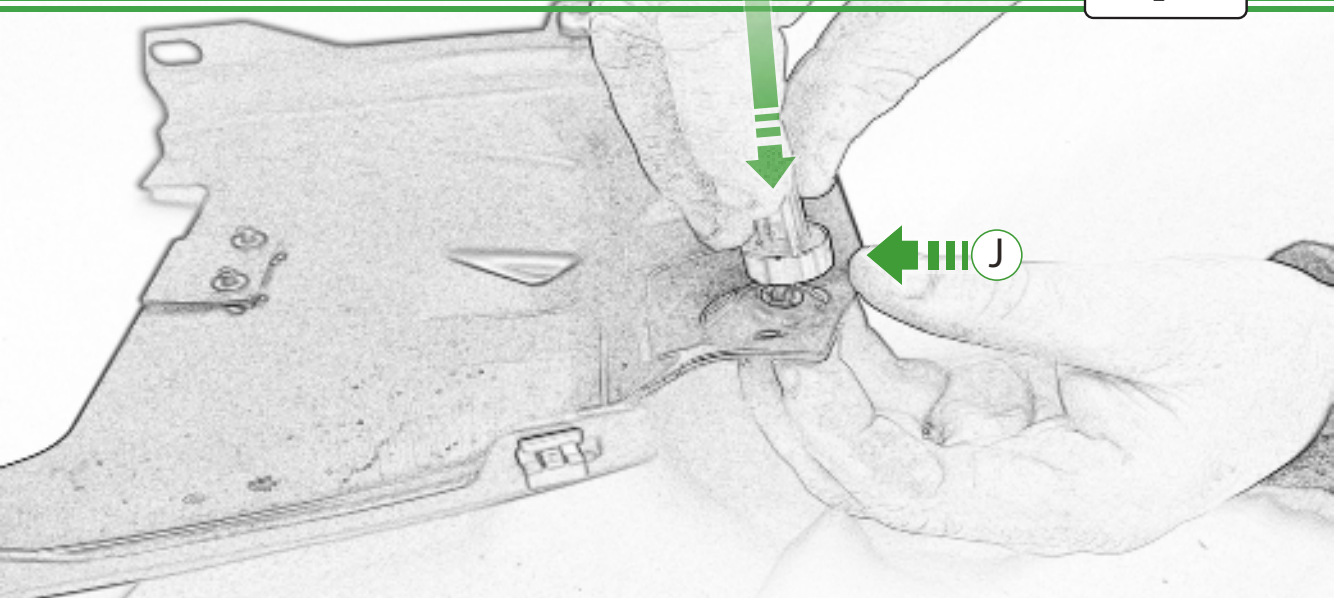

Repeat  
Both Sides



Do Not Fully  
Tighten

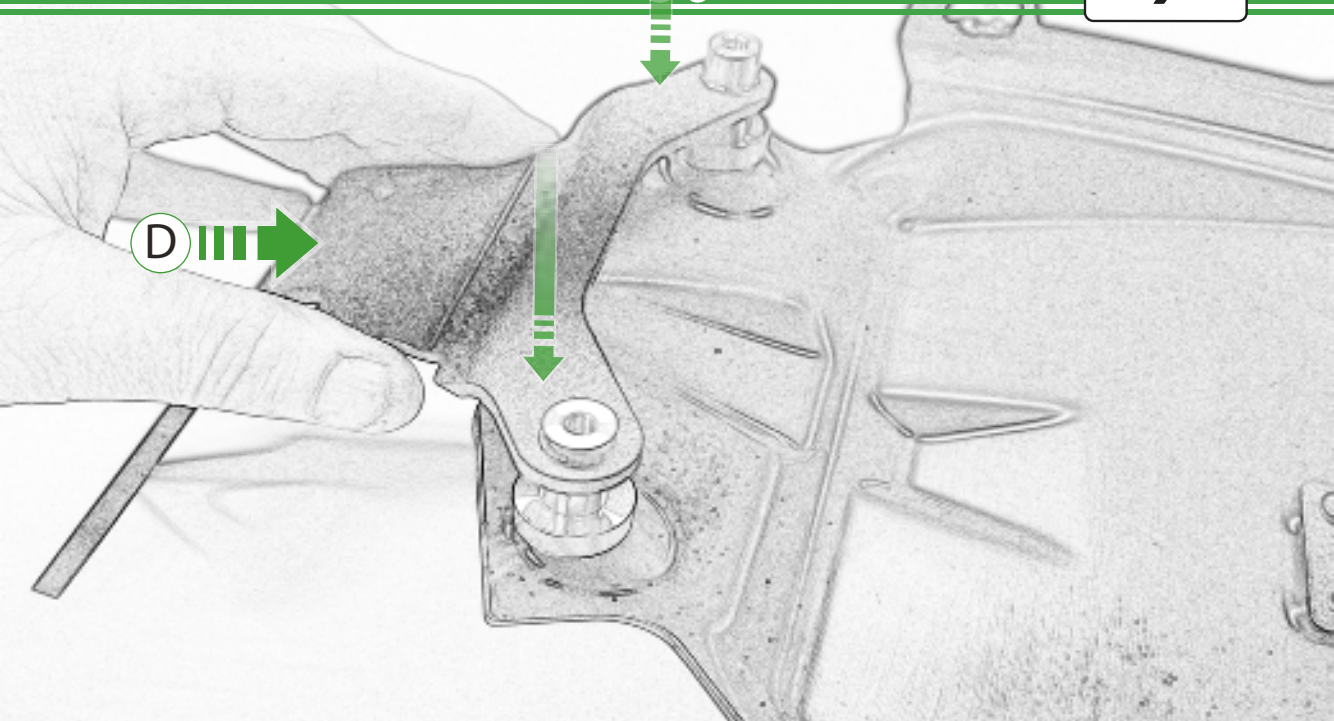

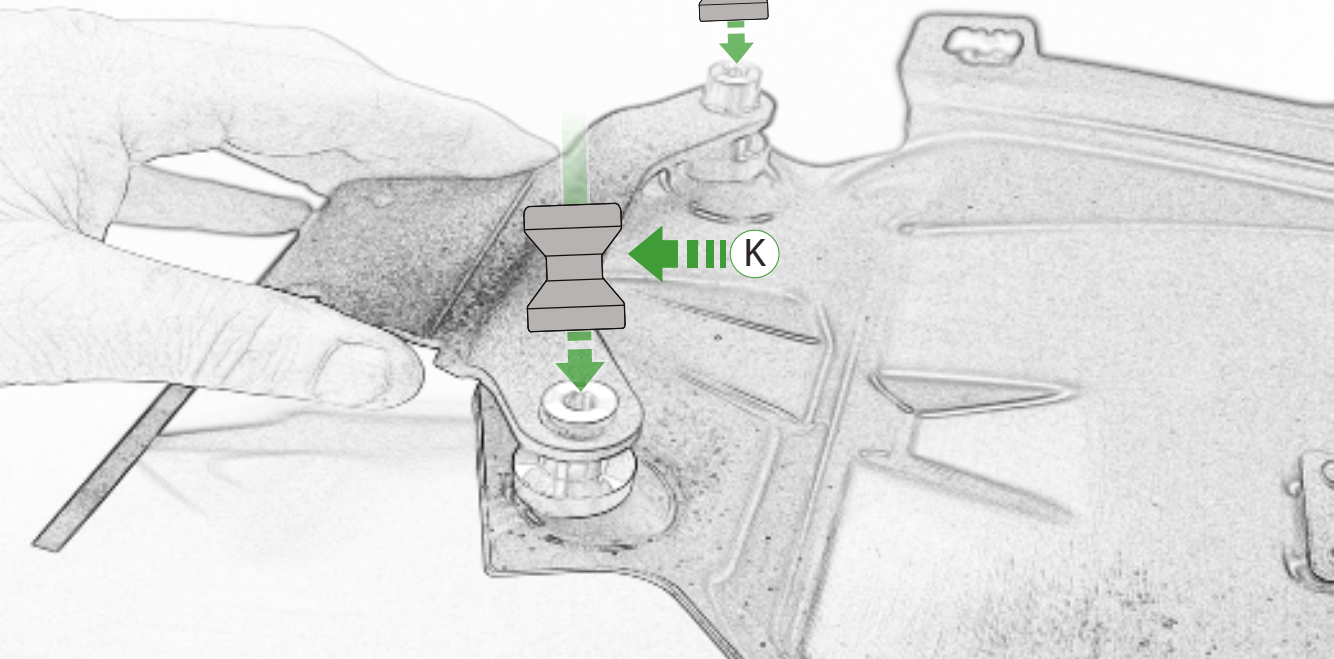

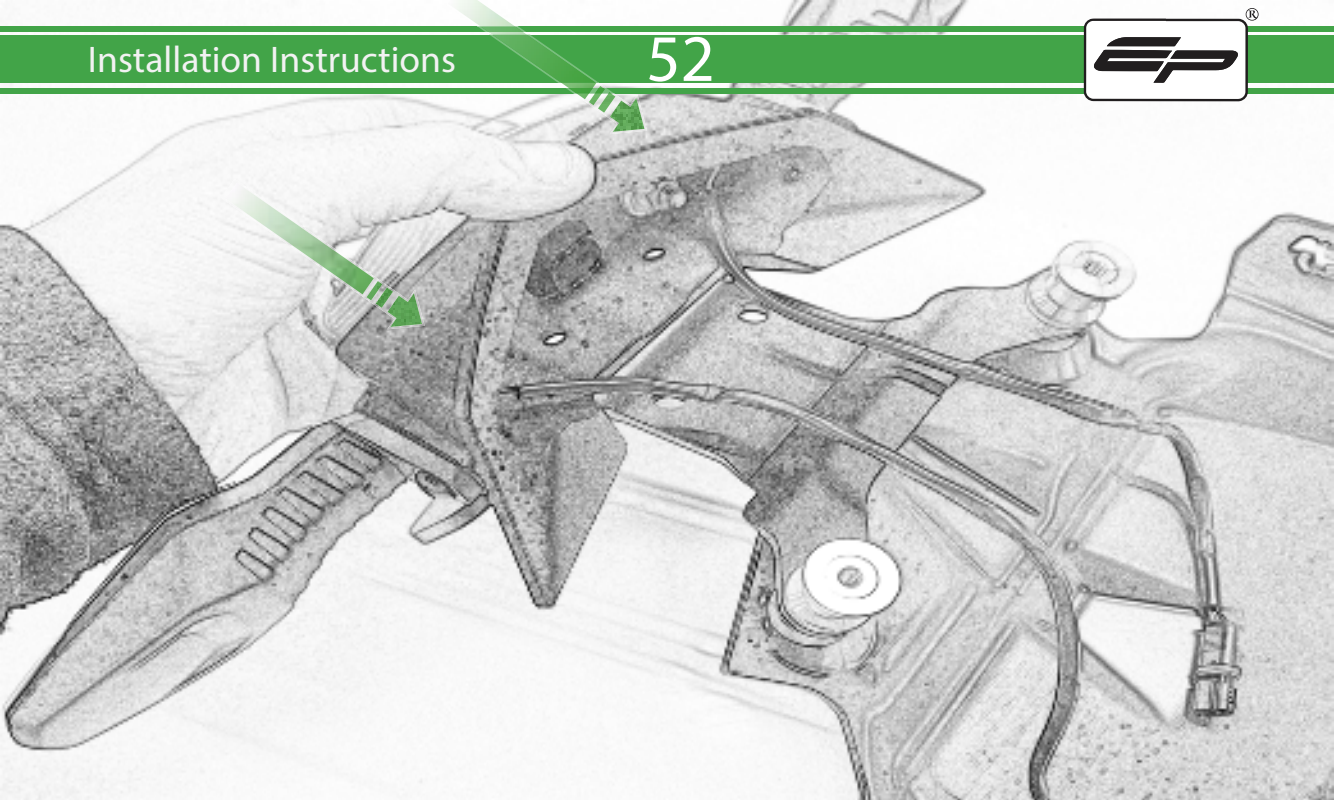

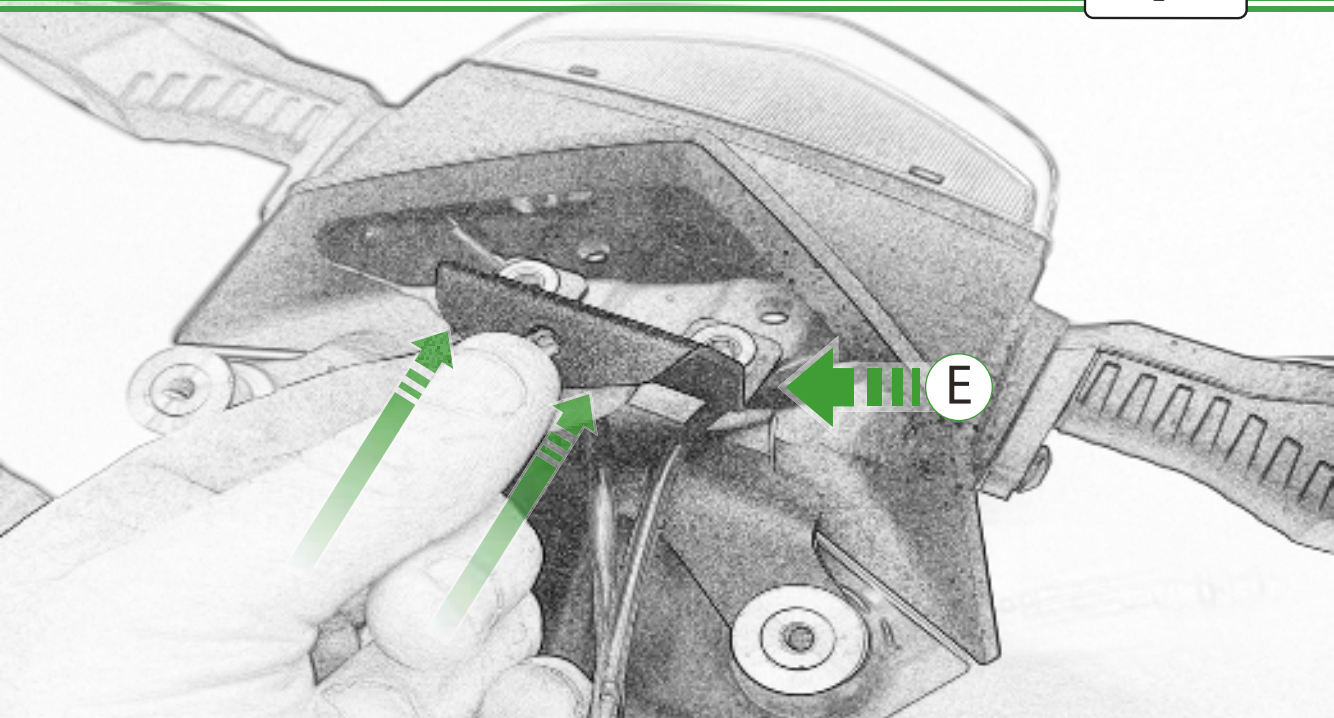

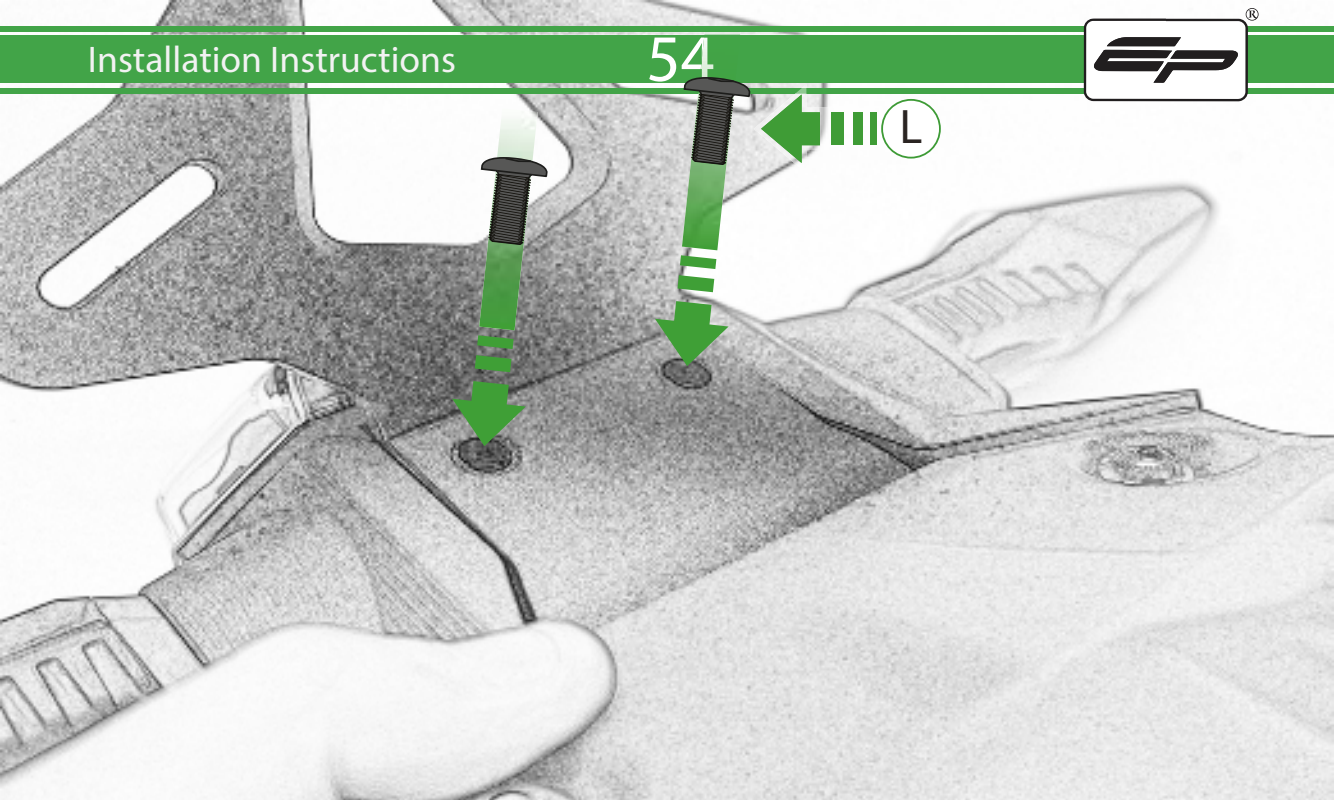



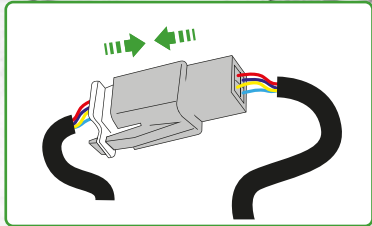
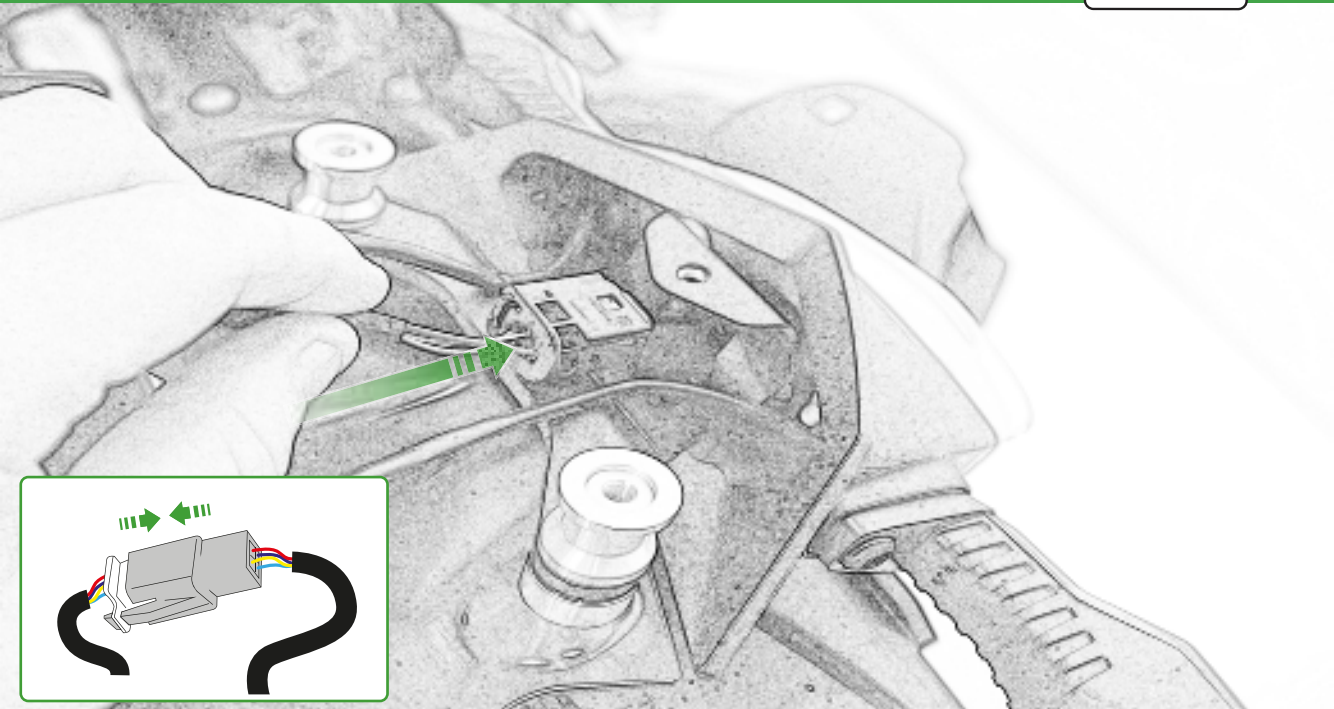

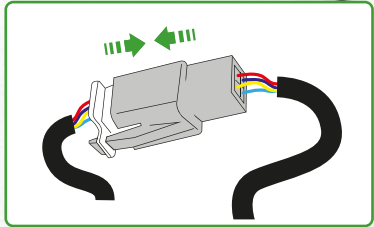
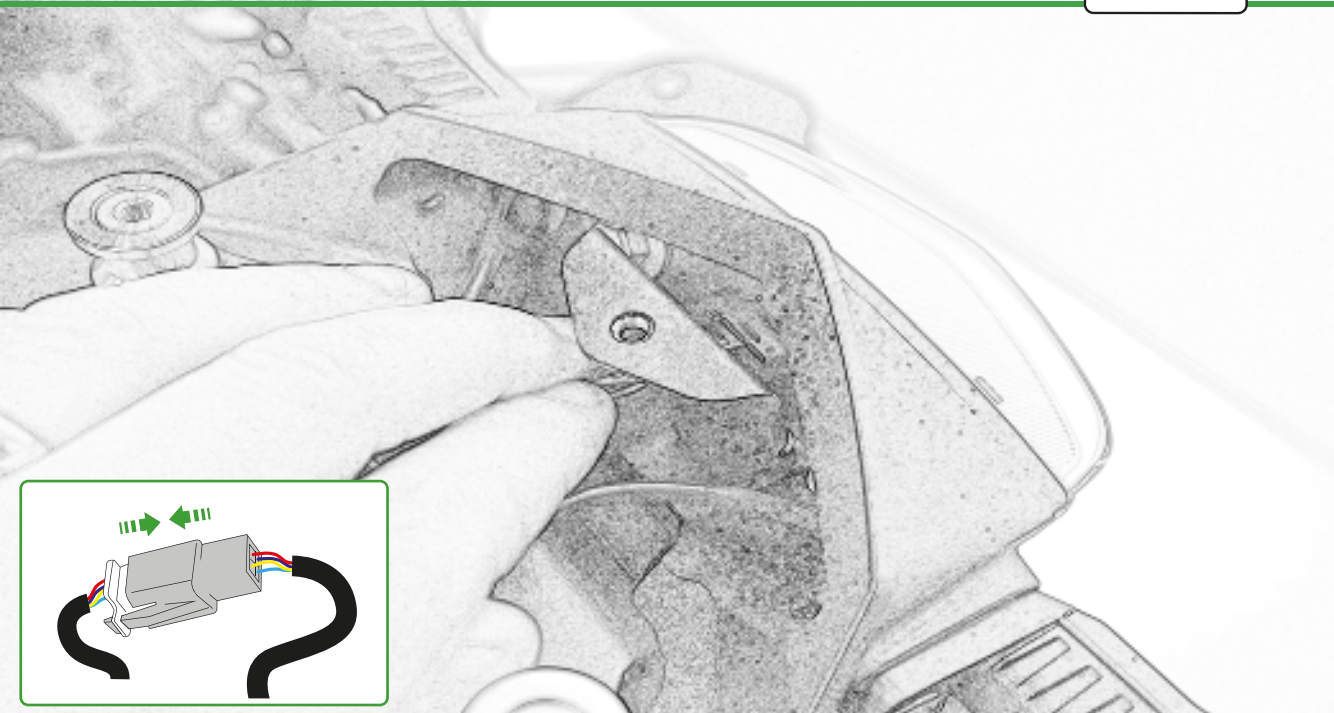

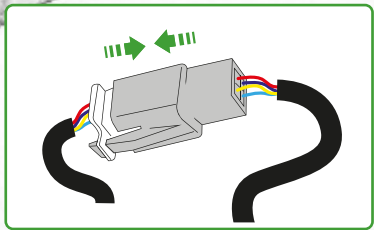
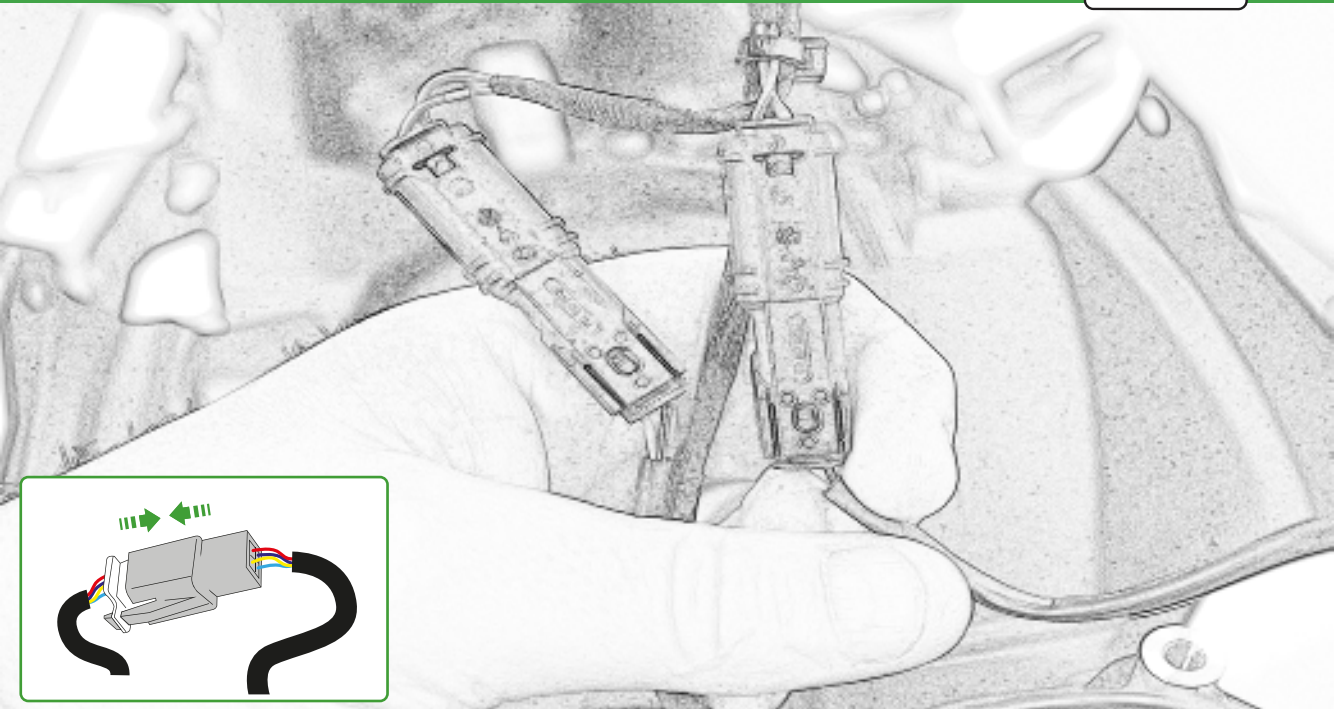

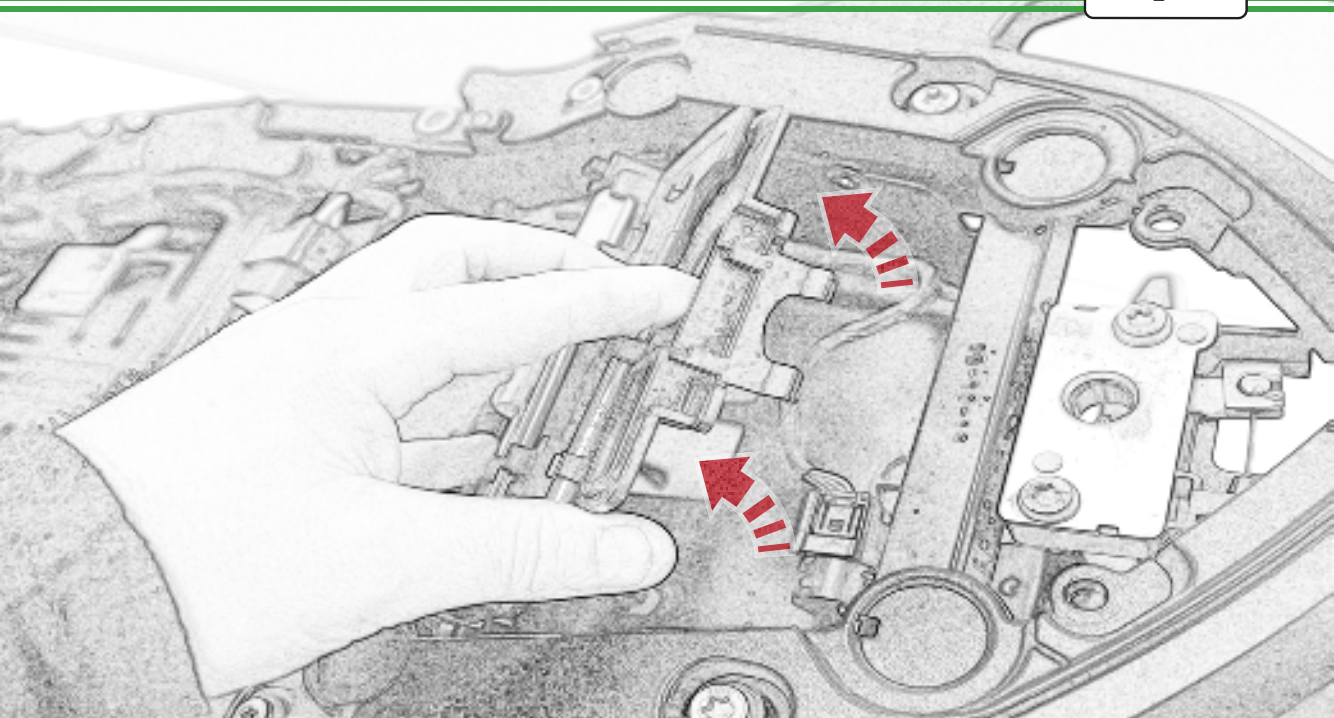

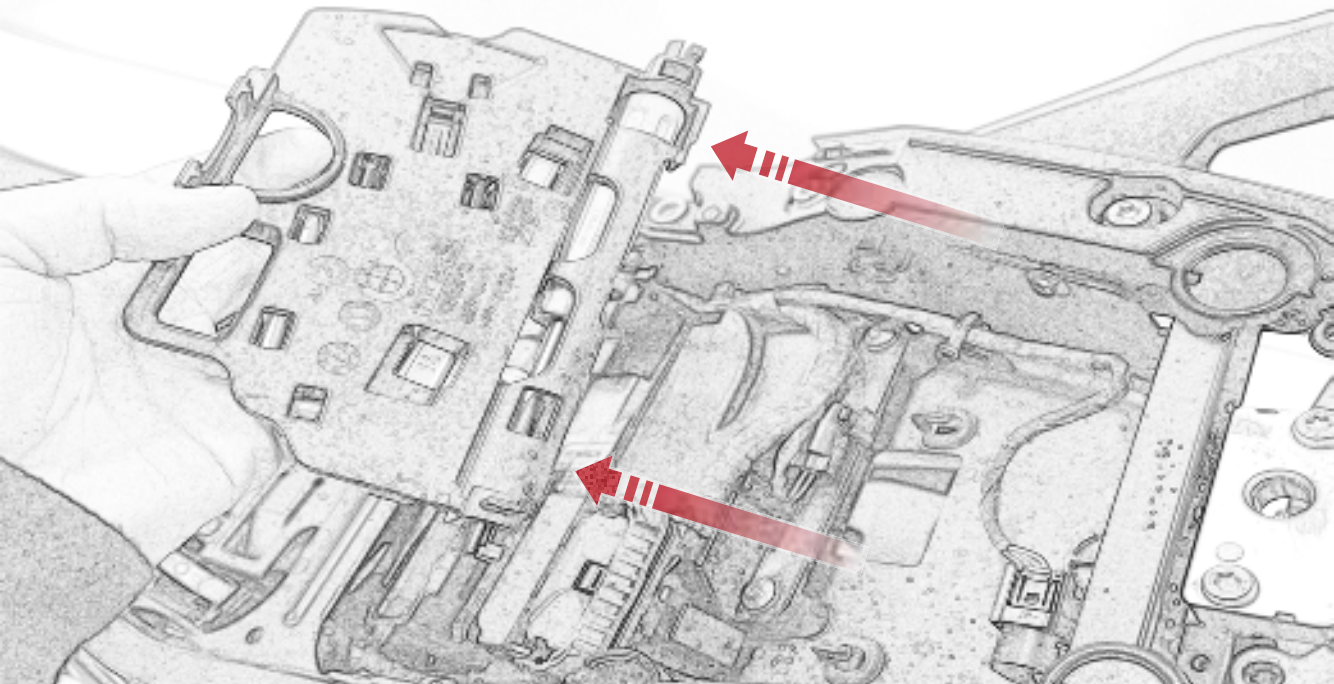



Caution

Locate loom in underseat area ensuring they do not get trapped or squashed

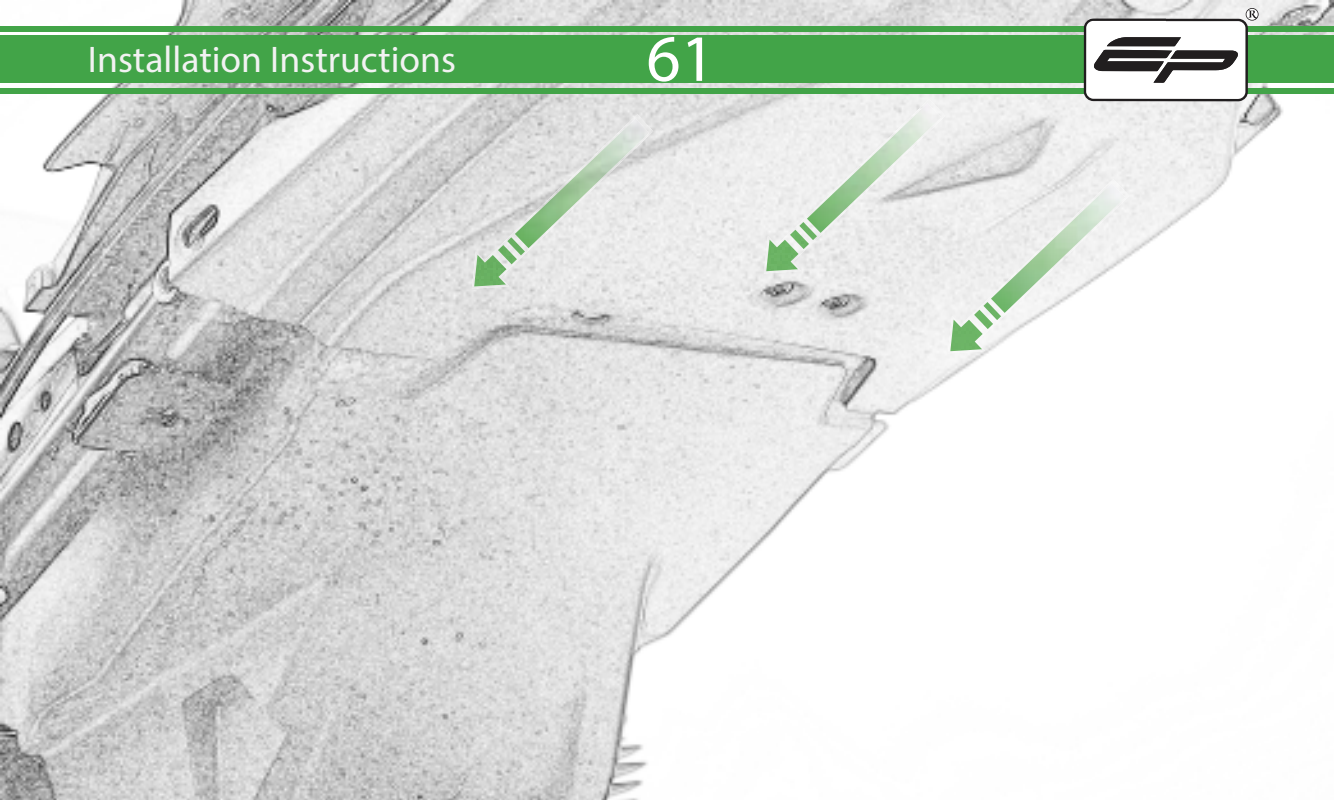

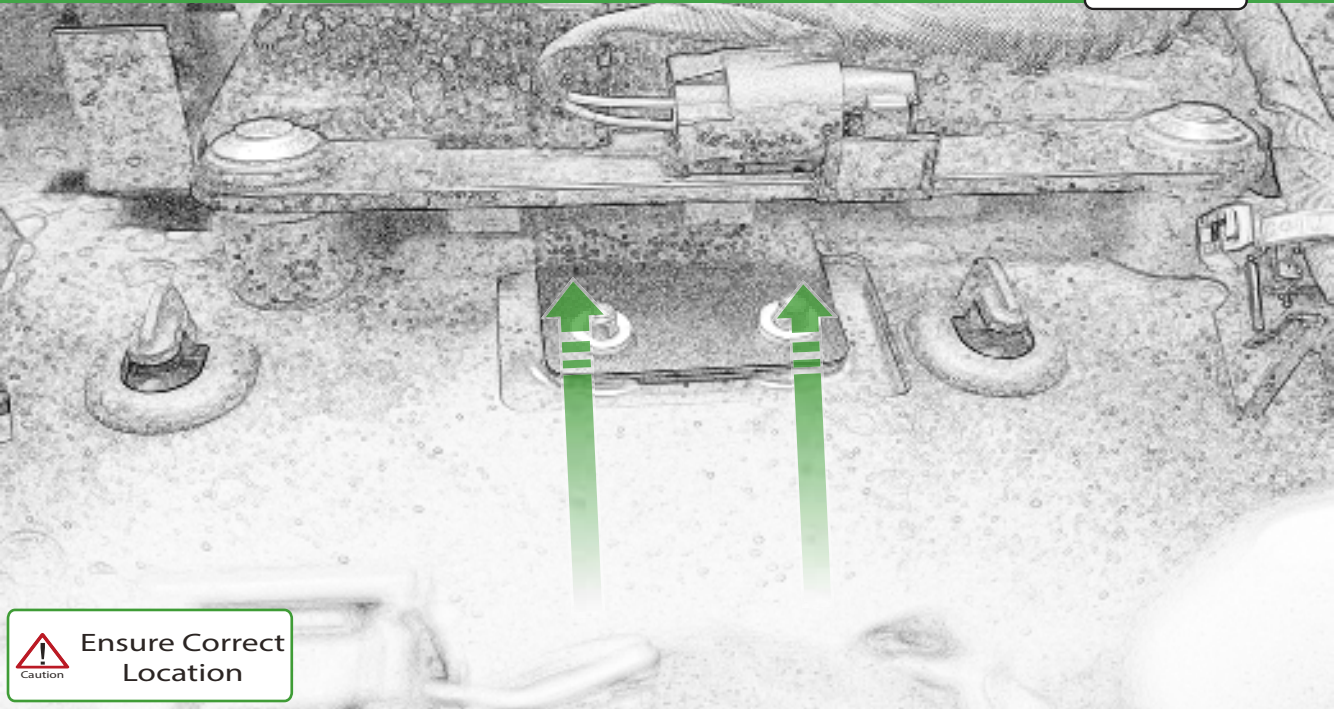

Ensure Correct  
Location





OEM PART

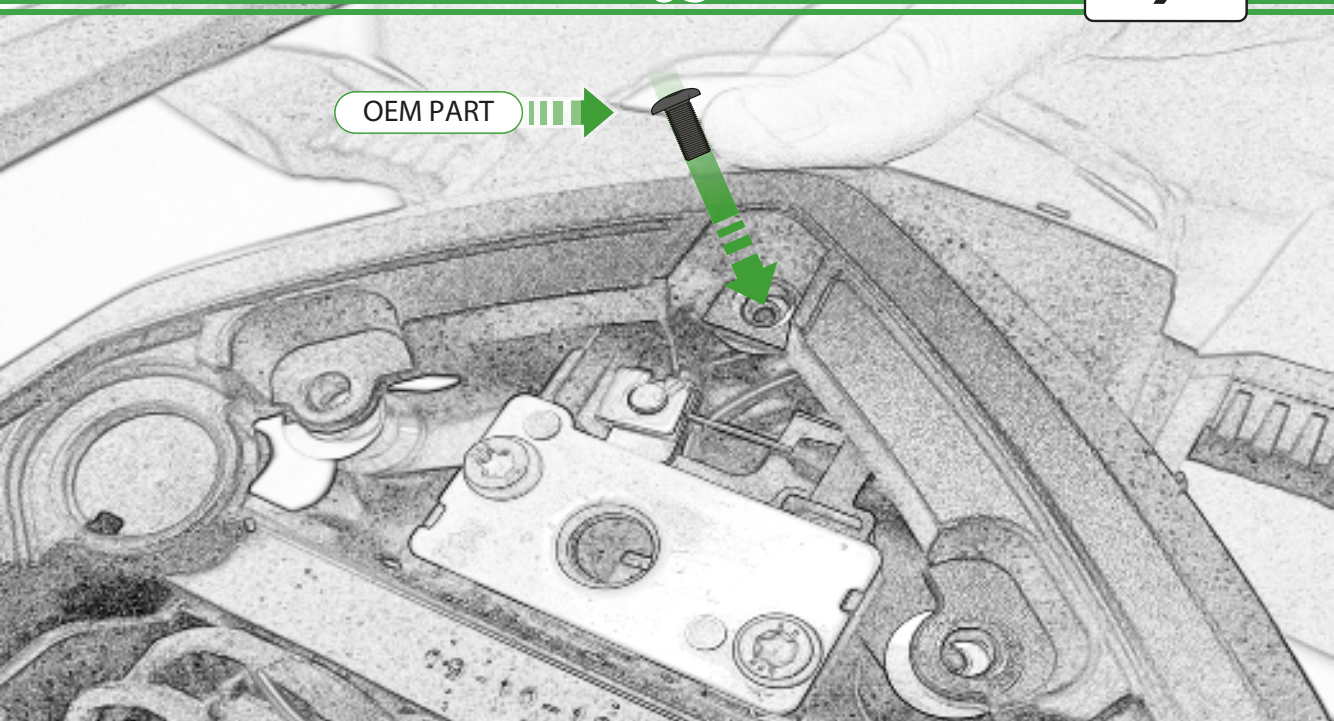

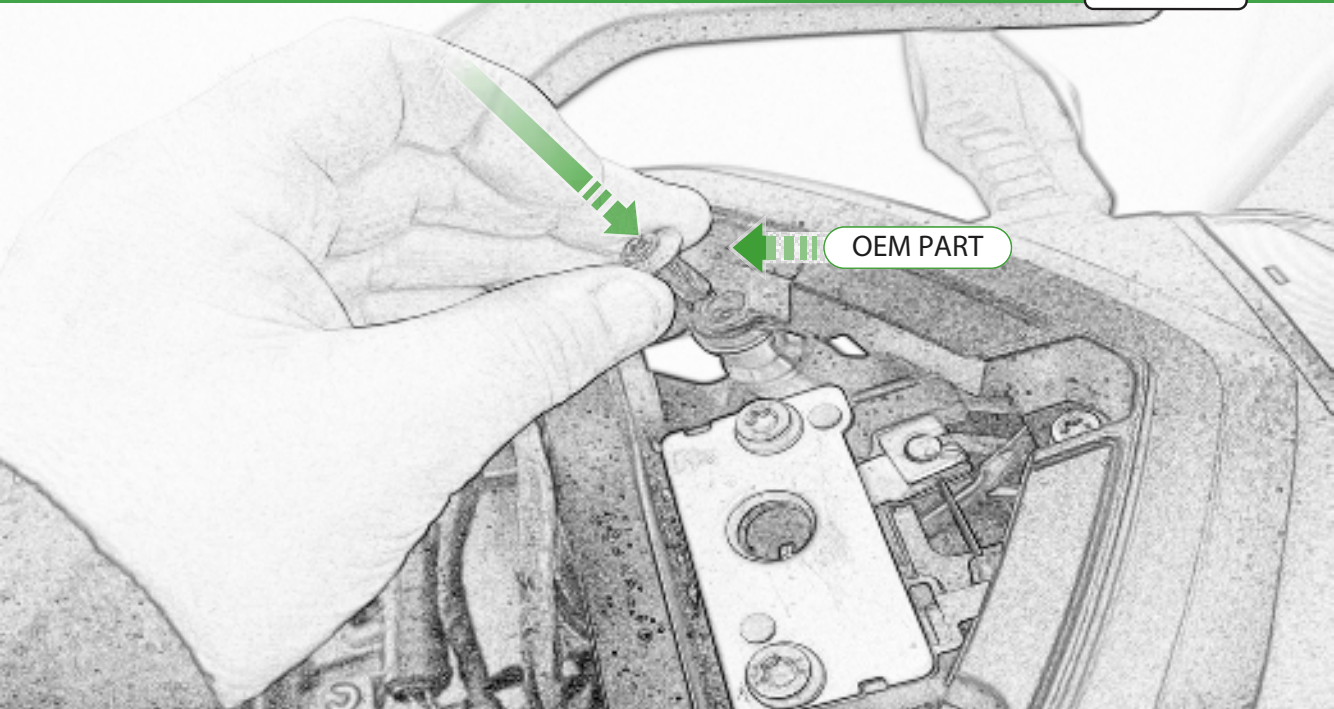

OEM PART

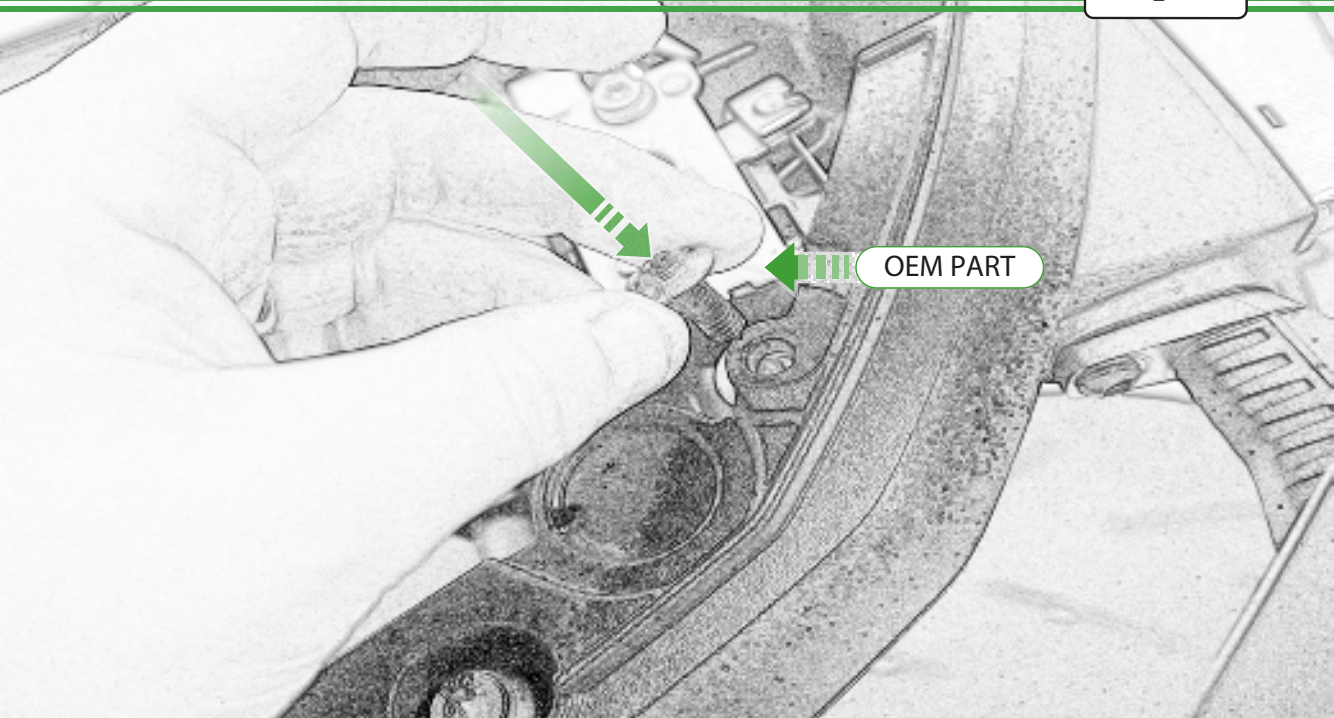

OEM PART

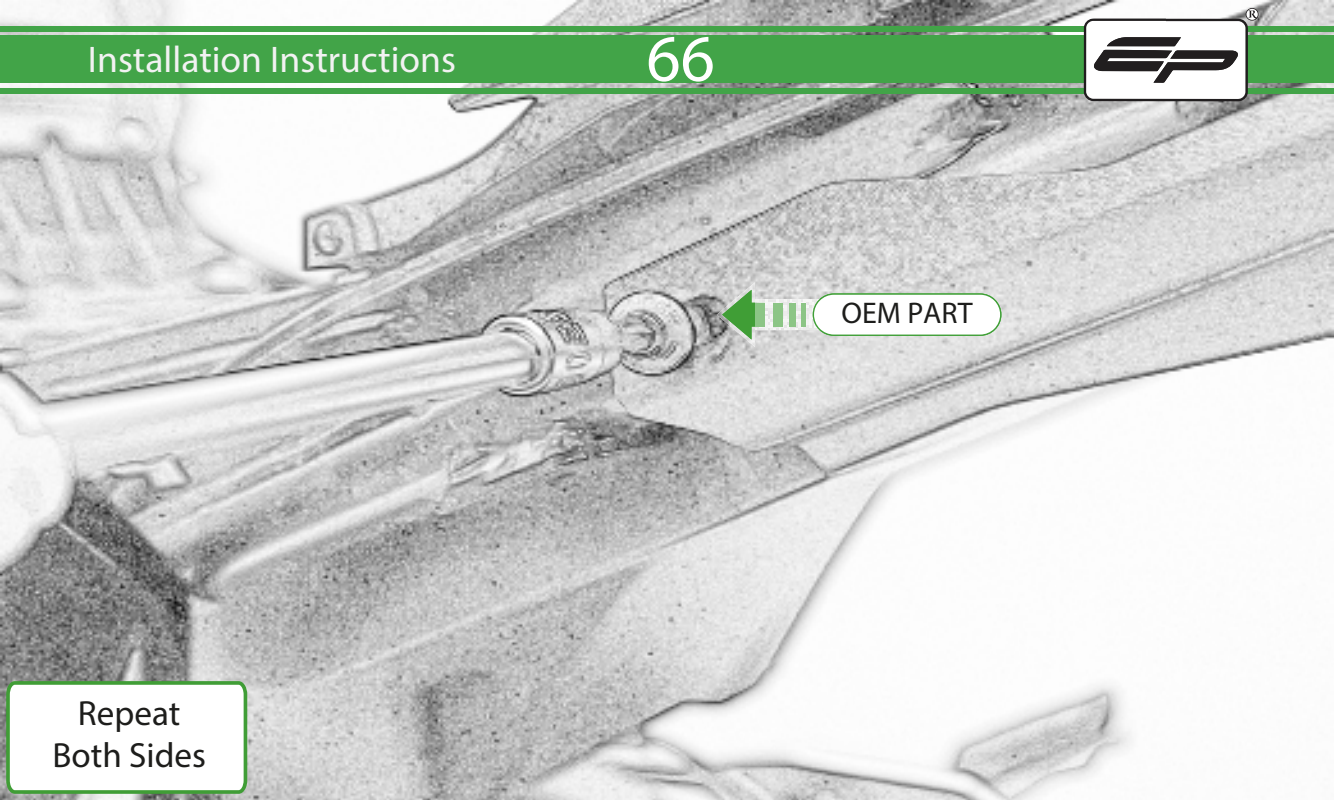

OEM PART

Repeat  
Both Sides

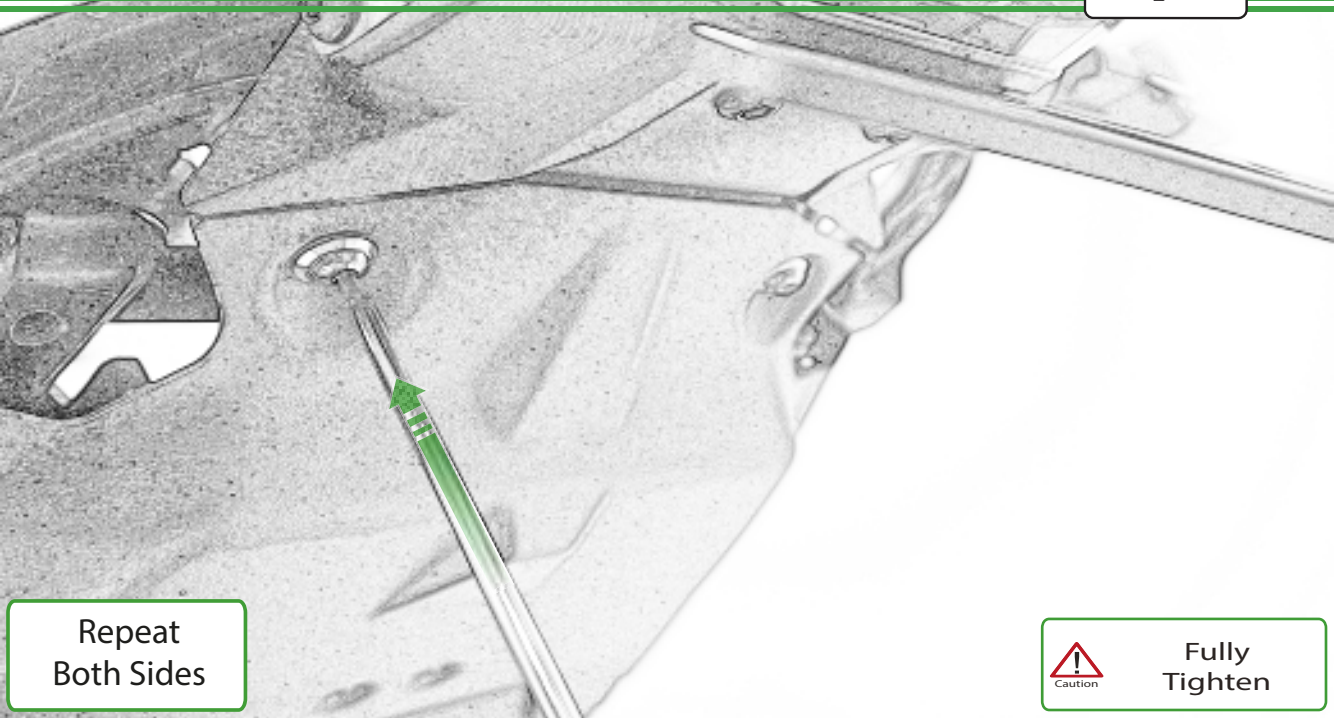

Repeat  
Both Sides



Fully  
Tighten

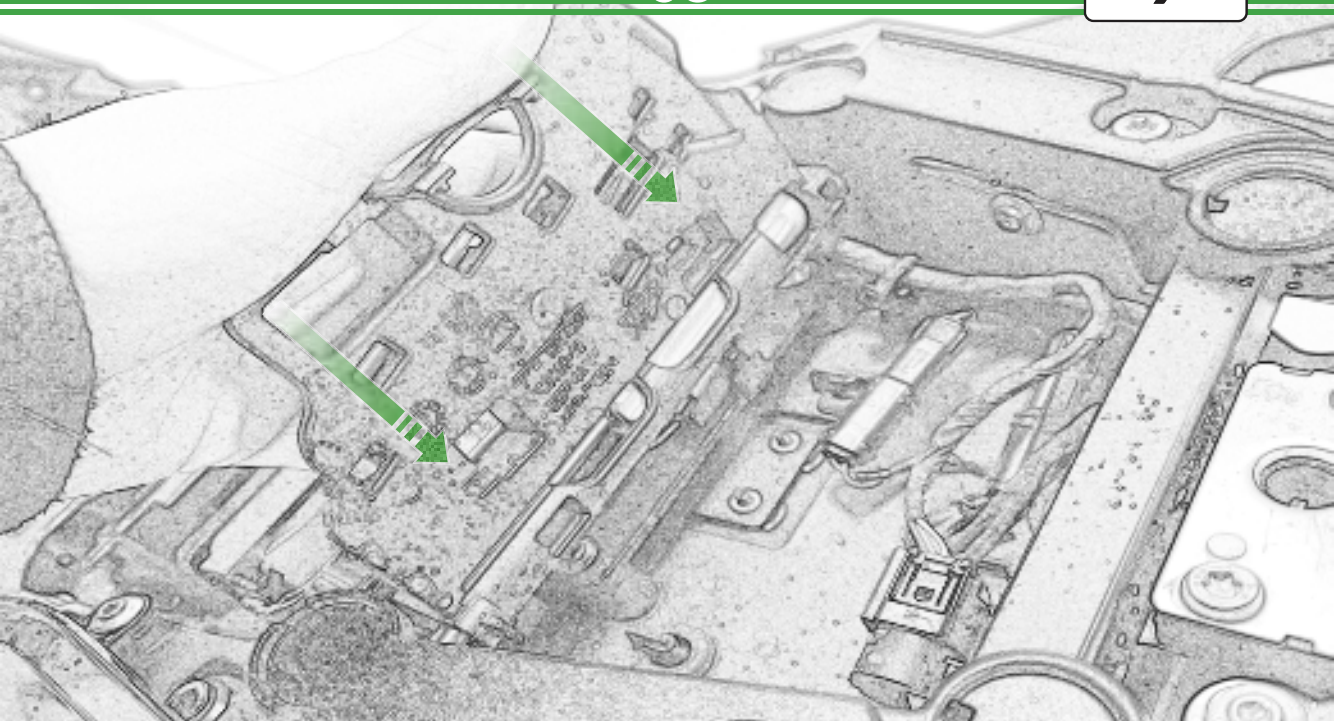

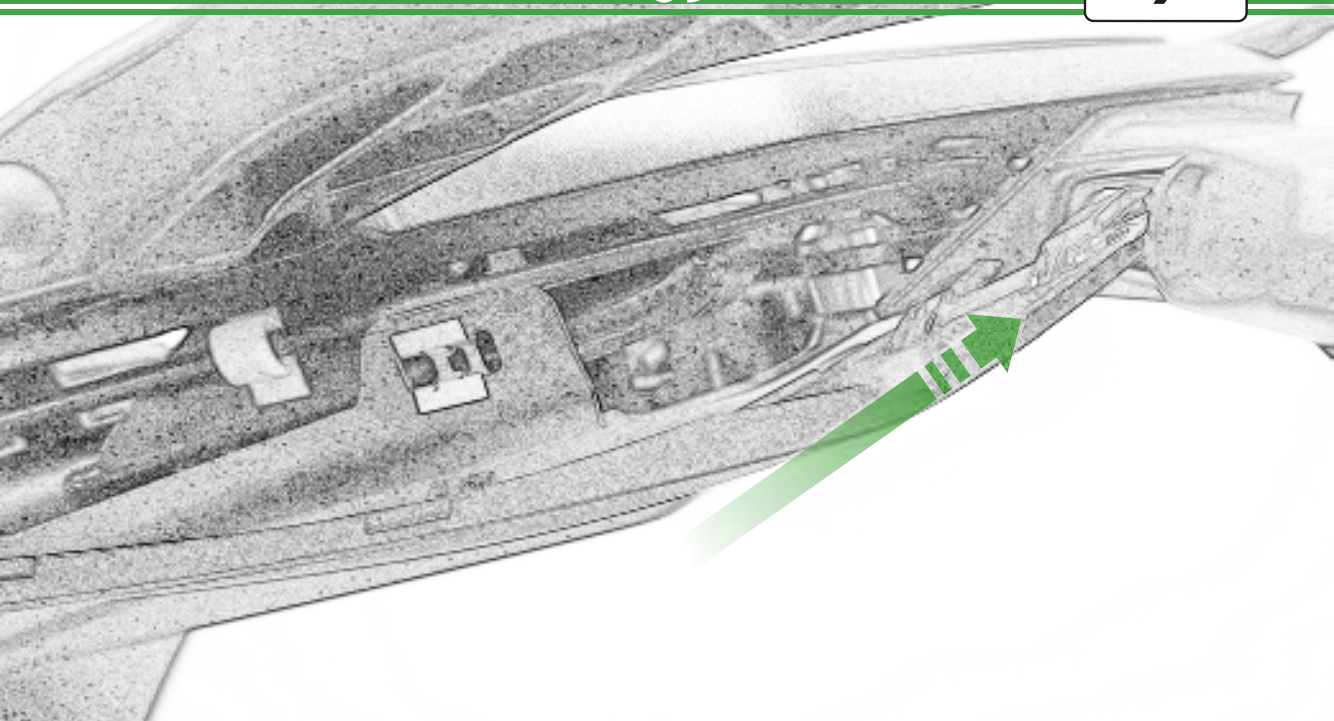

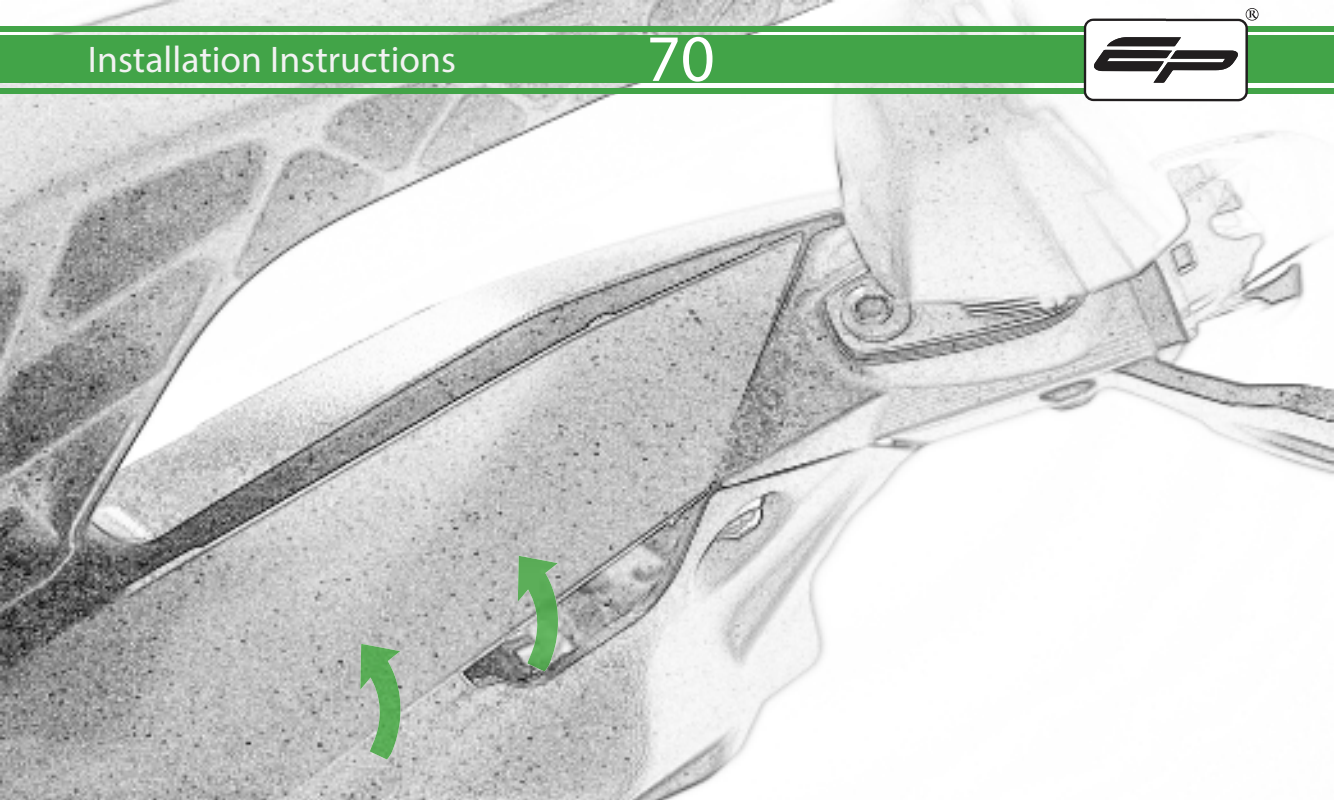



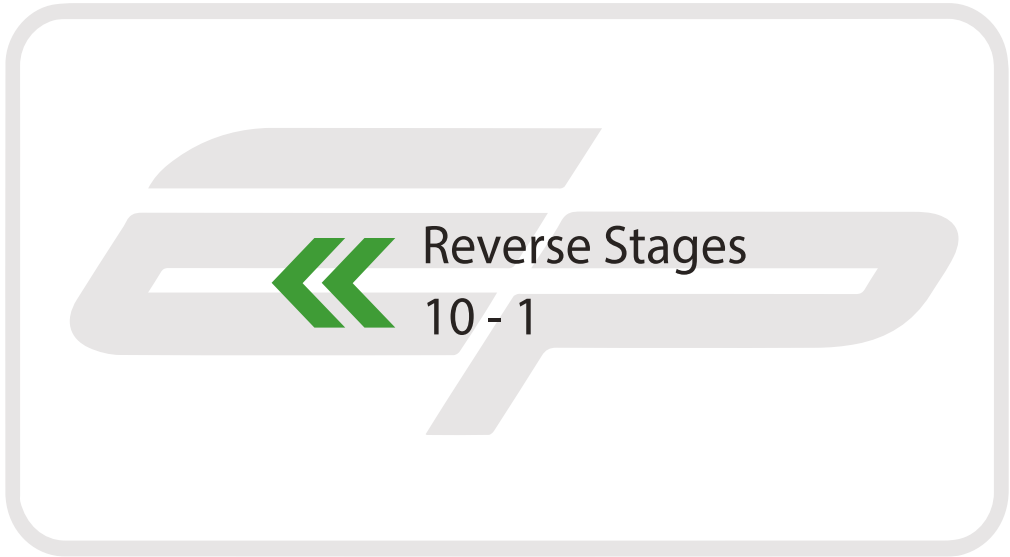

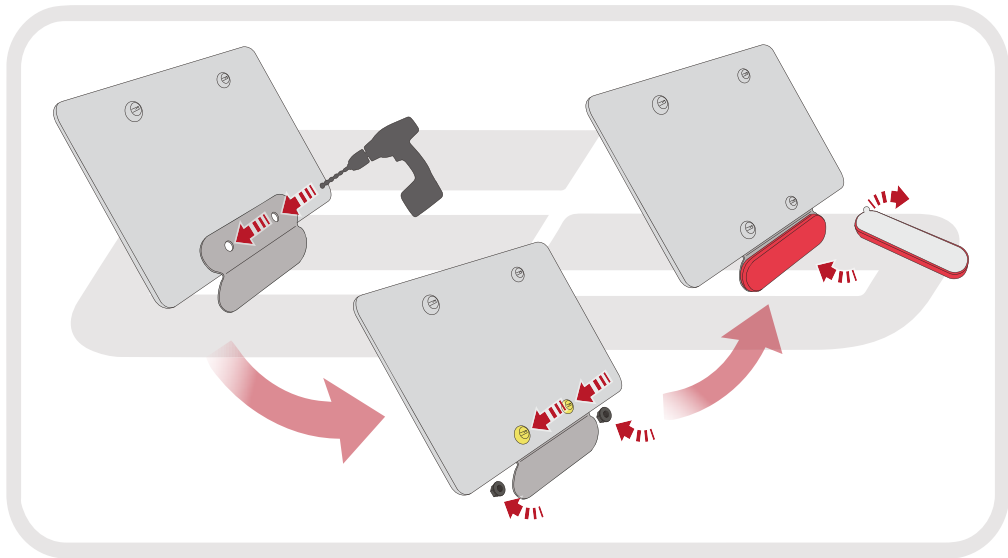

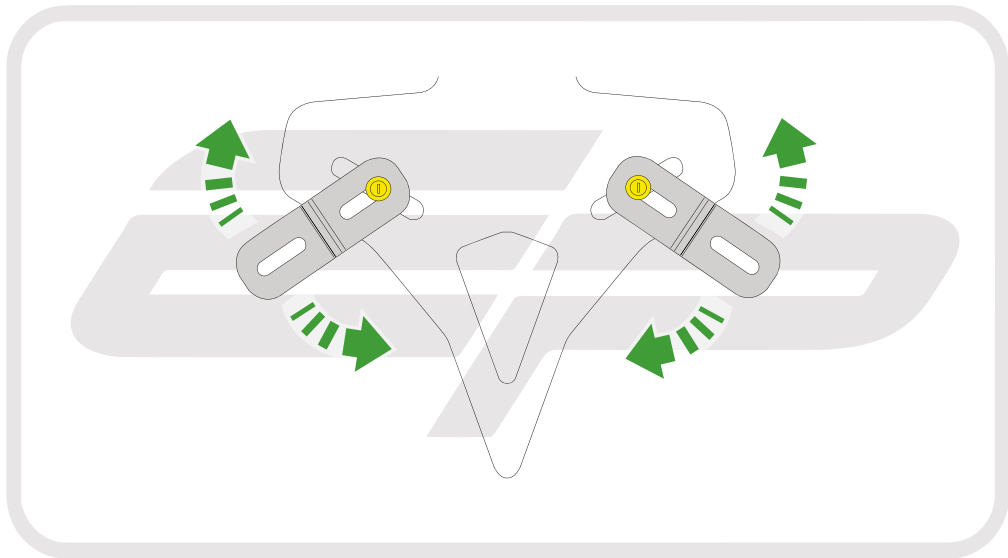



## ESSENTIAL CHECKS



After installation of your tail tidy ensure that the licence plate does not contact the rear tyre when suspension is fully compressed.

Ensure all electrics including indicators, tail light, brake light and licence plate light lights are working correctly before riding the motorcycle.

It is recommended that periodic inspections are made to ensure that all fixings are fully tightend.



**EVOTECH**®  
P E R F O R M A N C E

[www.evotech-performance.com](http://www.evotech-performance.com)