

EVOTECH®
P E R F O R M A N C E

KTM 1290 Super Duke R

Tail Tidy

Installation Instructions



Kit Contents PRN014798

- Ⓐ 1 x Reflector Kit
- Ⓑ 1 x Retro Light
- Ⓒ 1 x Loom Connector No.27
- Ⓓ 1 x M4 x 8 Button Head Bolt
- Ⓔ 1 x R /H Main Body
- Ⓕ 1 x L /H Main Body
- Ⓖ 1 x Retro Light Bracket
- Ⓗ 1 x Numberplate Bracket
- Ⓘ 2 x Standard Indicator Spacer
- Ⓙ 2 x Indicator Spacer Extension (For Wide Number Plate)
- Ⓚ 2 x M5 x 40 Caphead Bolt
- Ⓛ 2 x M5 x 12 Caphead Bolt
- Ⓜ 2 x M4 Nyloc nuts
- Ⓝ 2 x M5 x 10 Button Head Bolt
- Ⓞ 4 x M6 x 12 Button head Bolts

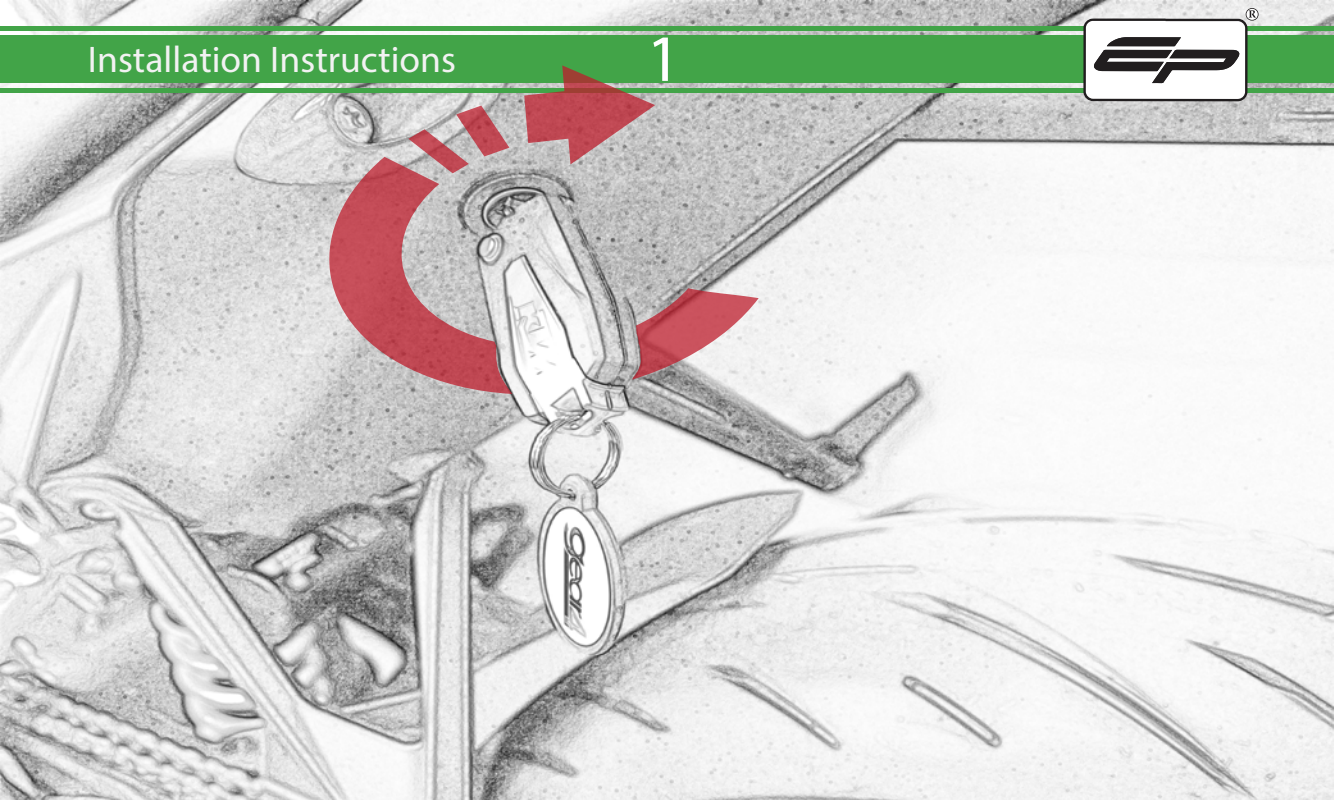

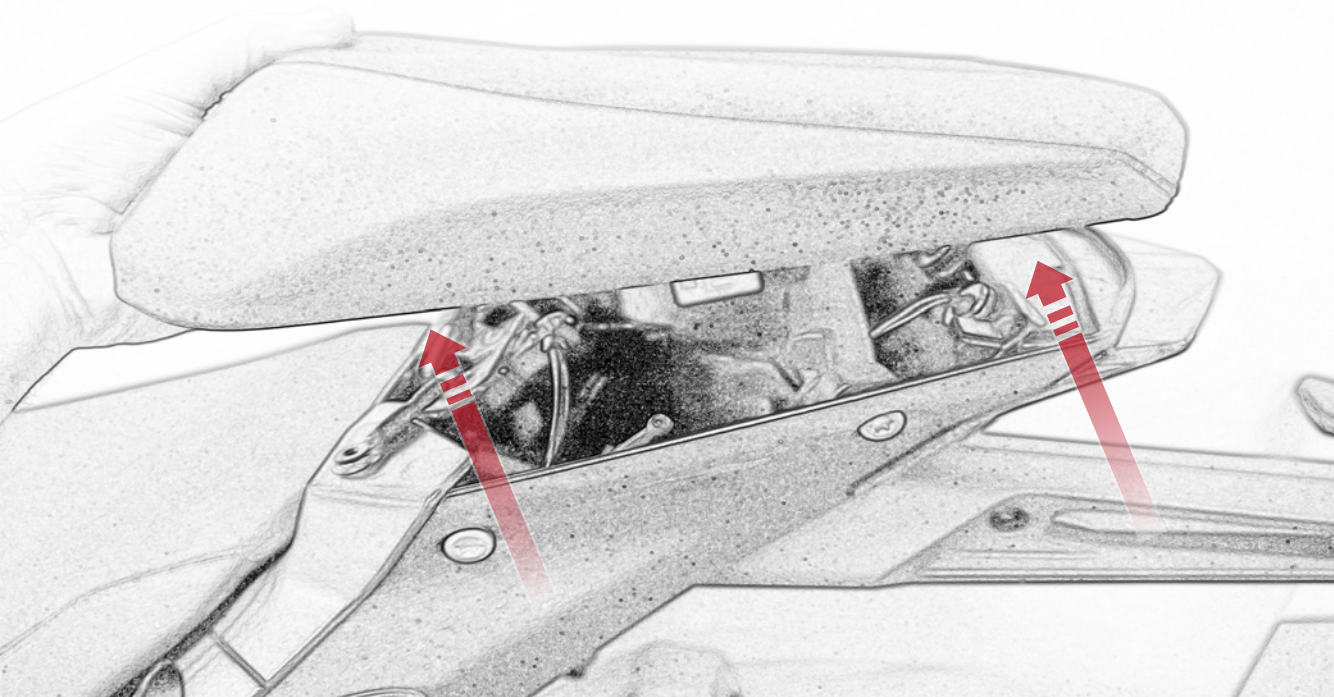

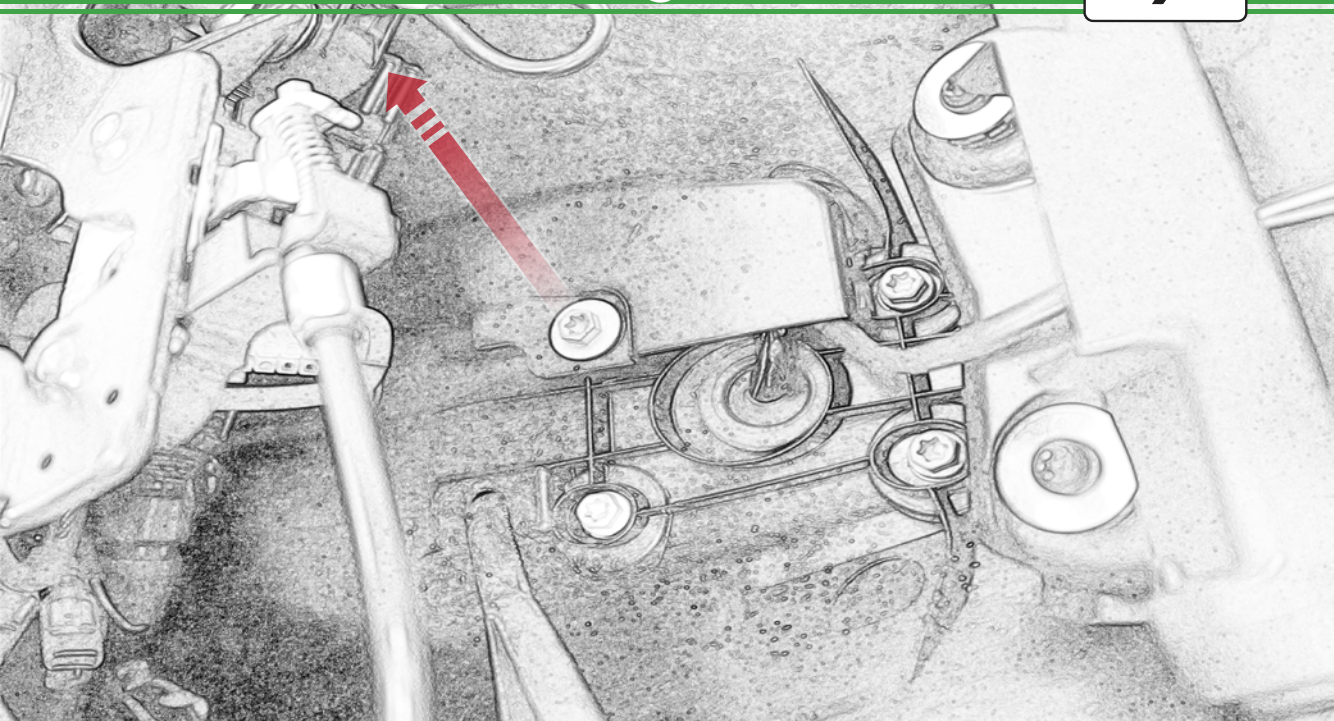

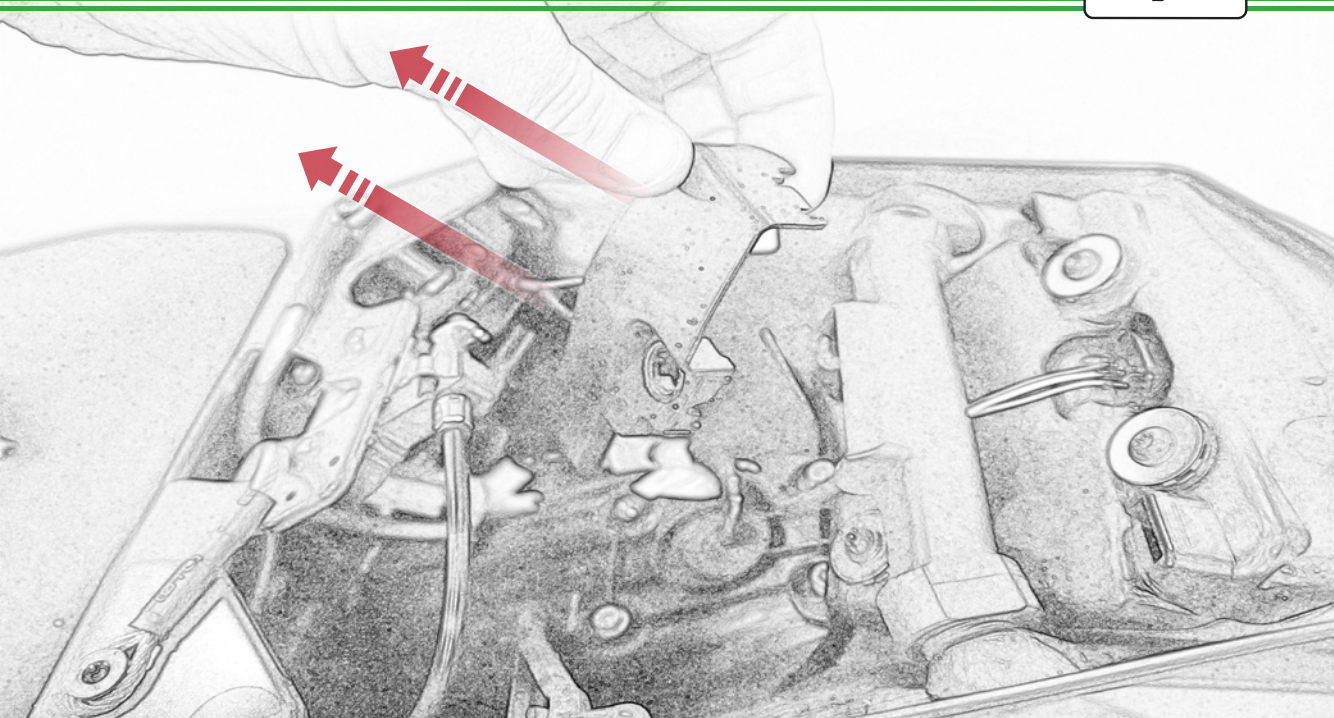

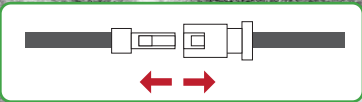
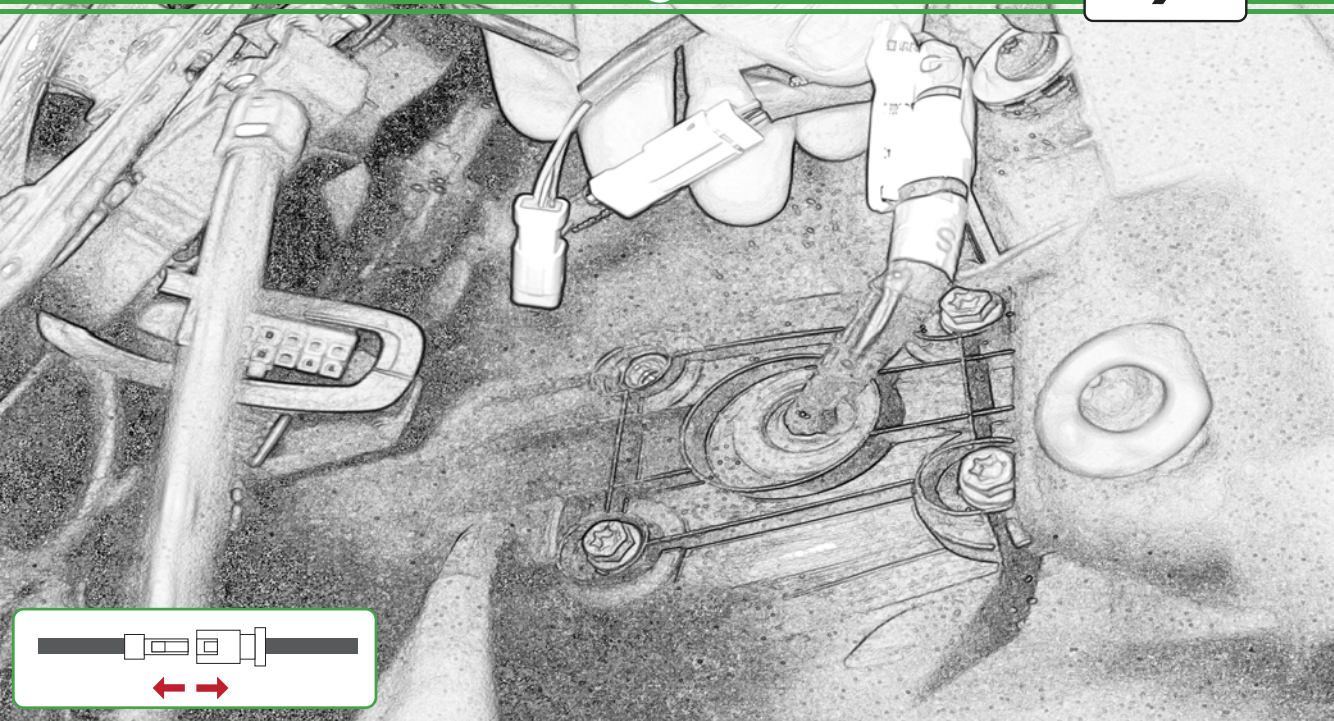

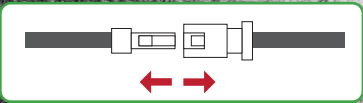
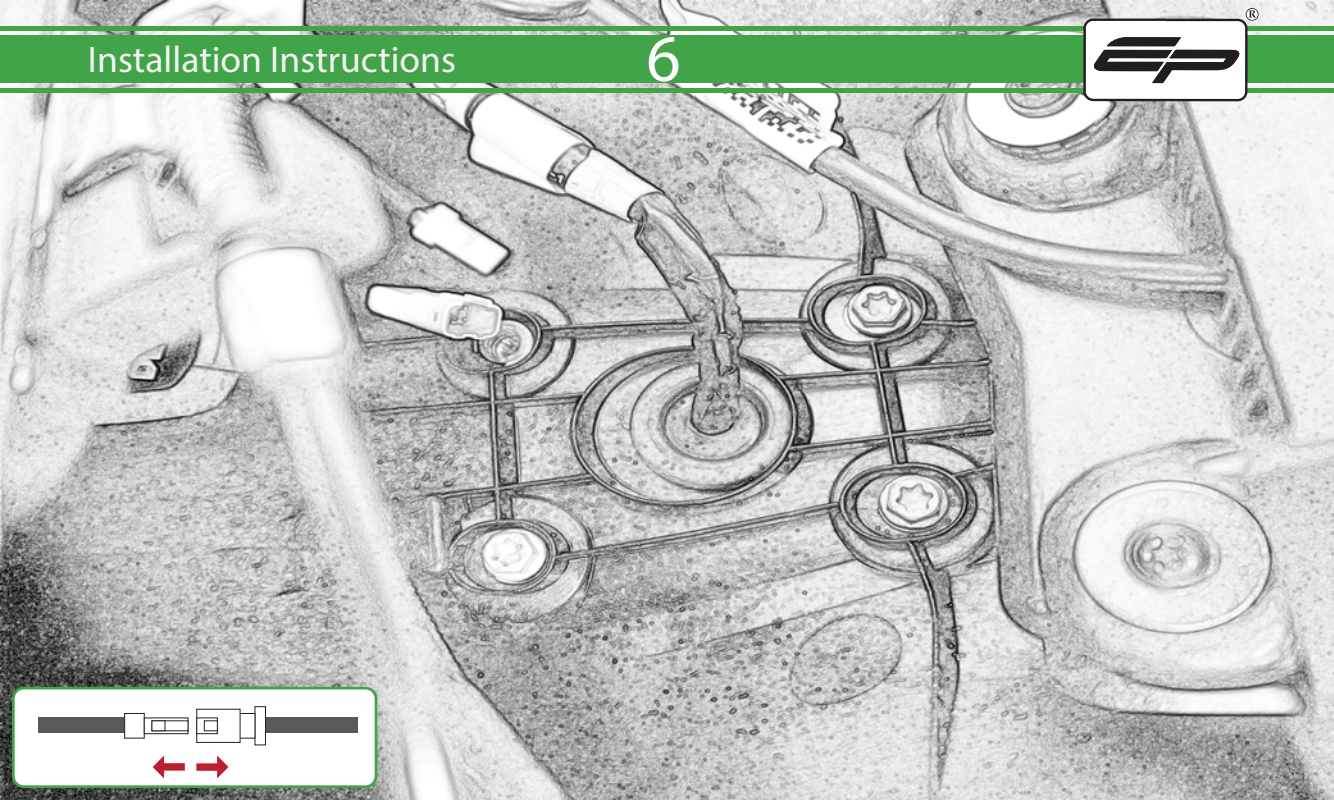

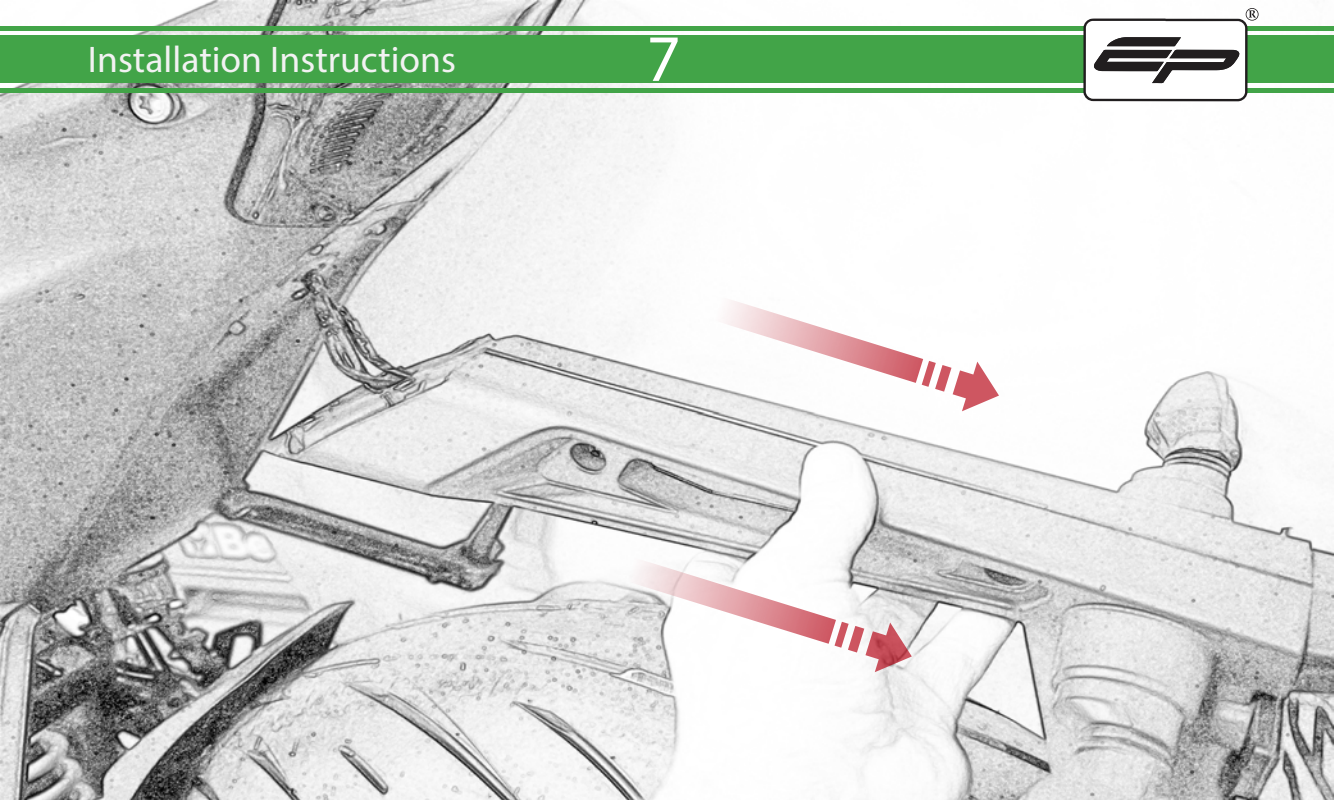

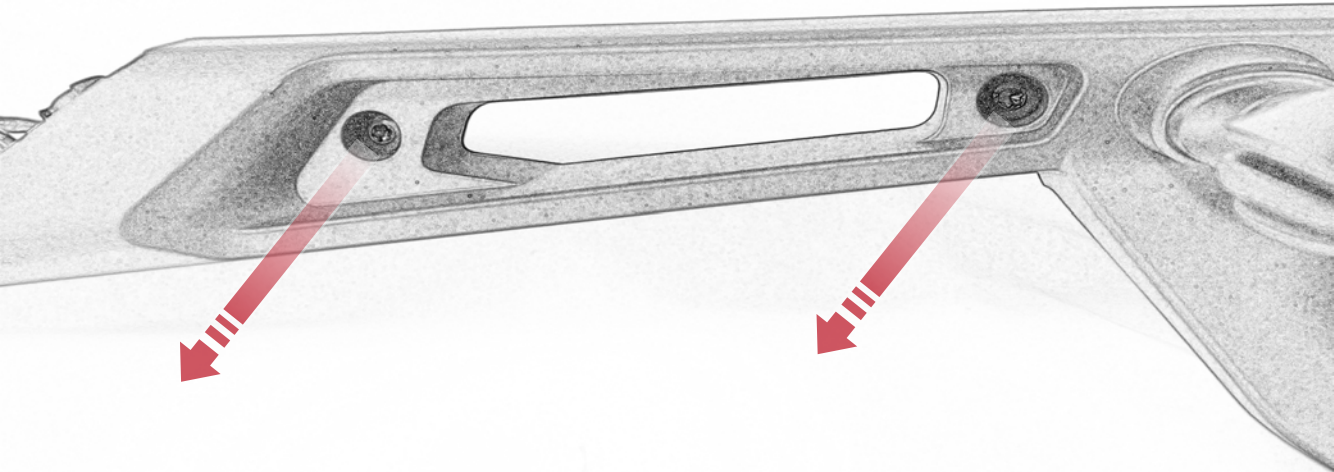

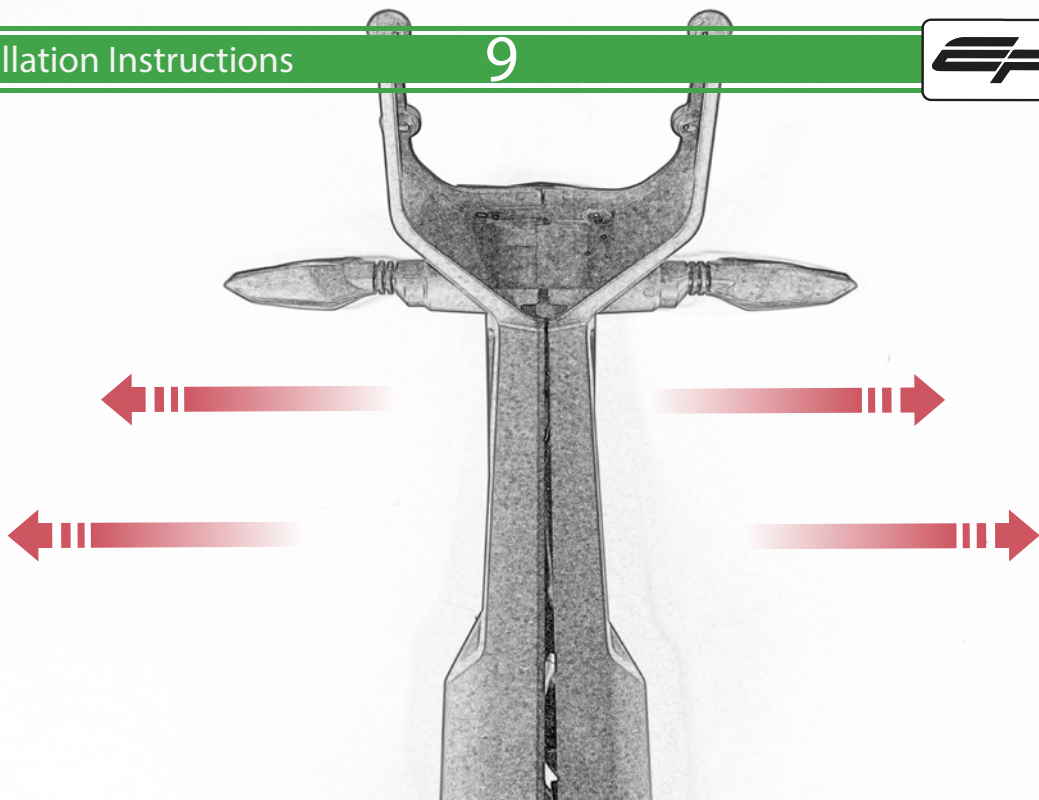

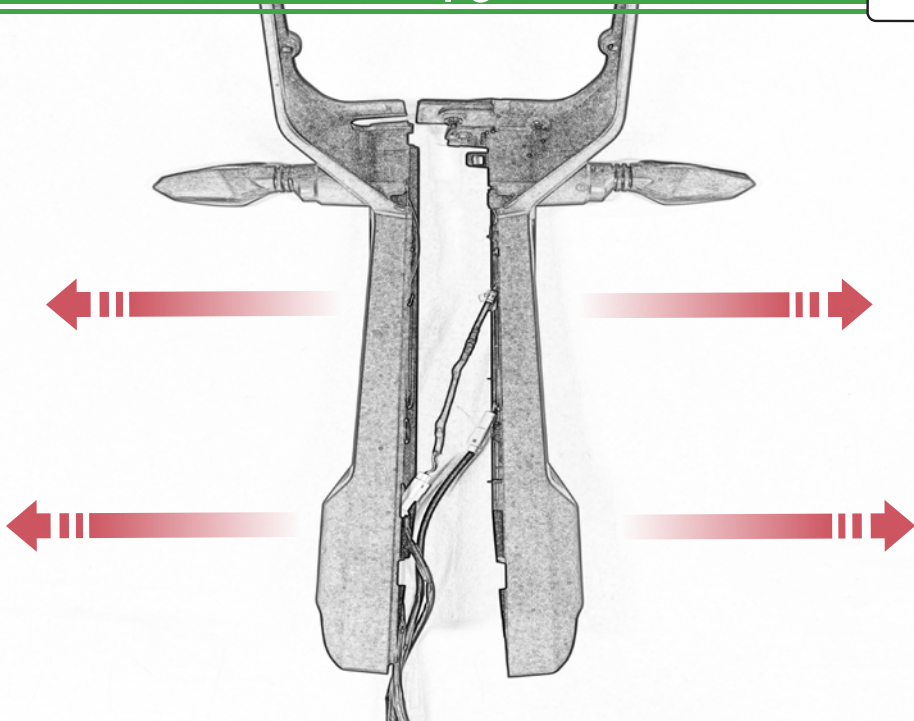

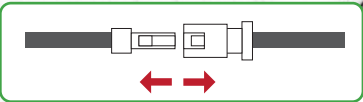
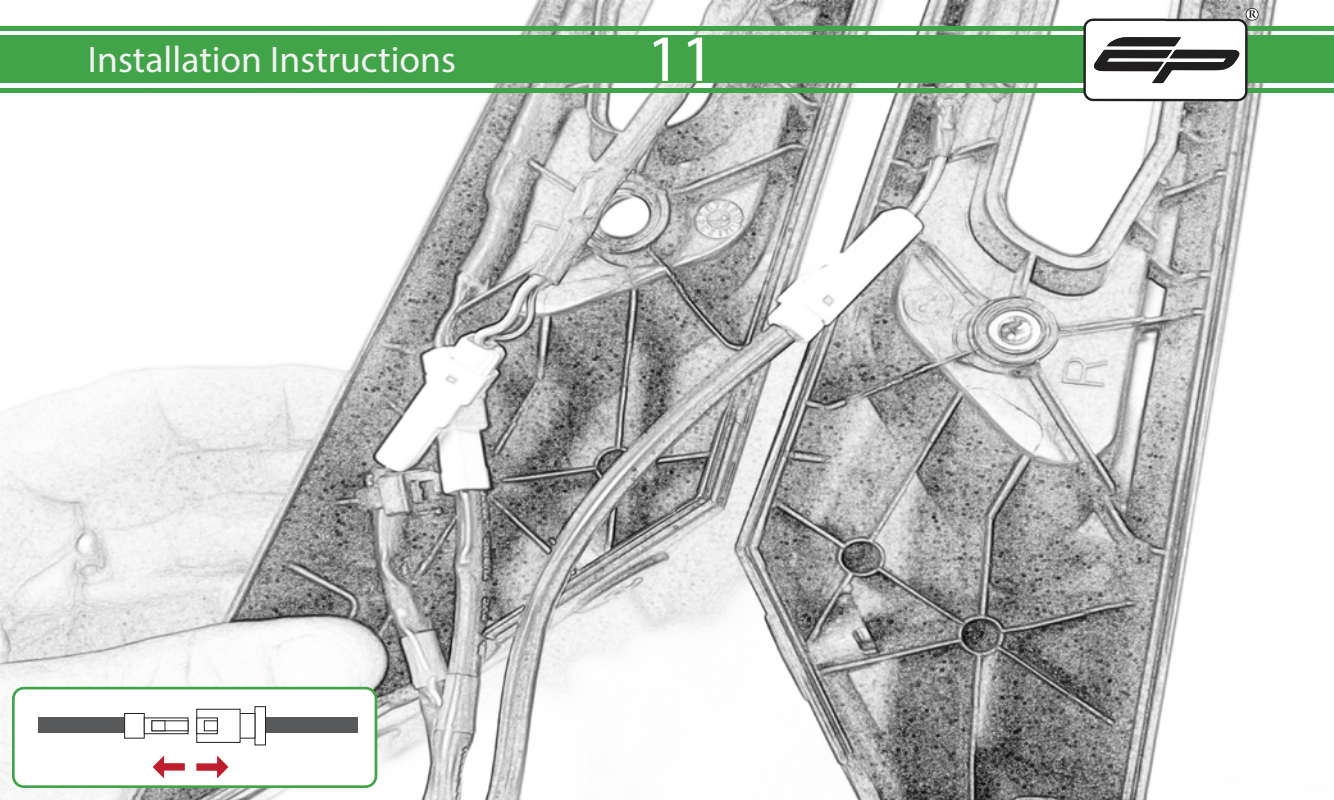

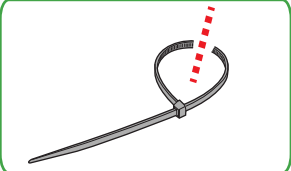
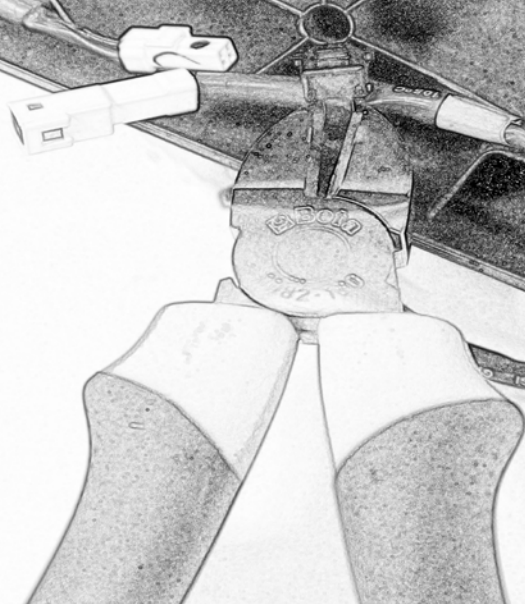

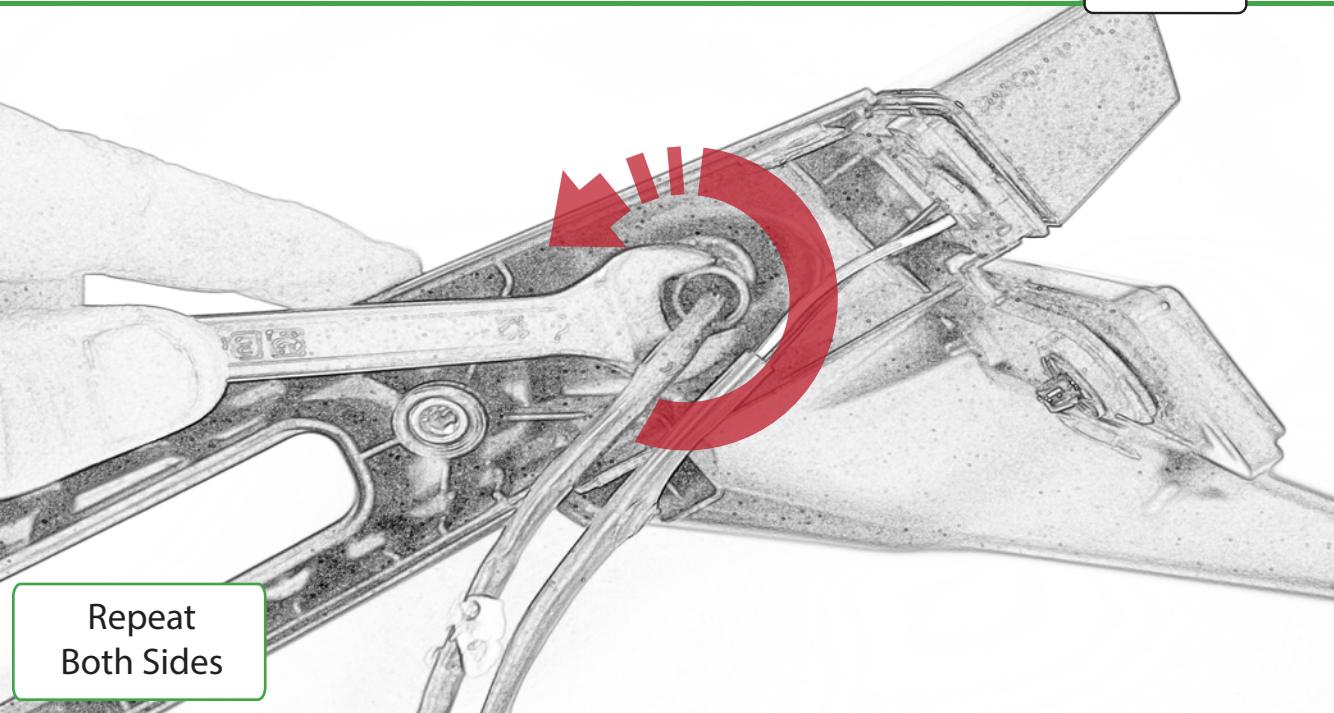

Repeat
Both Sides

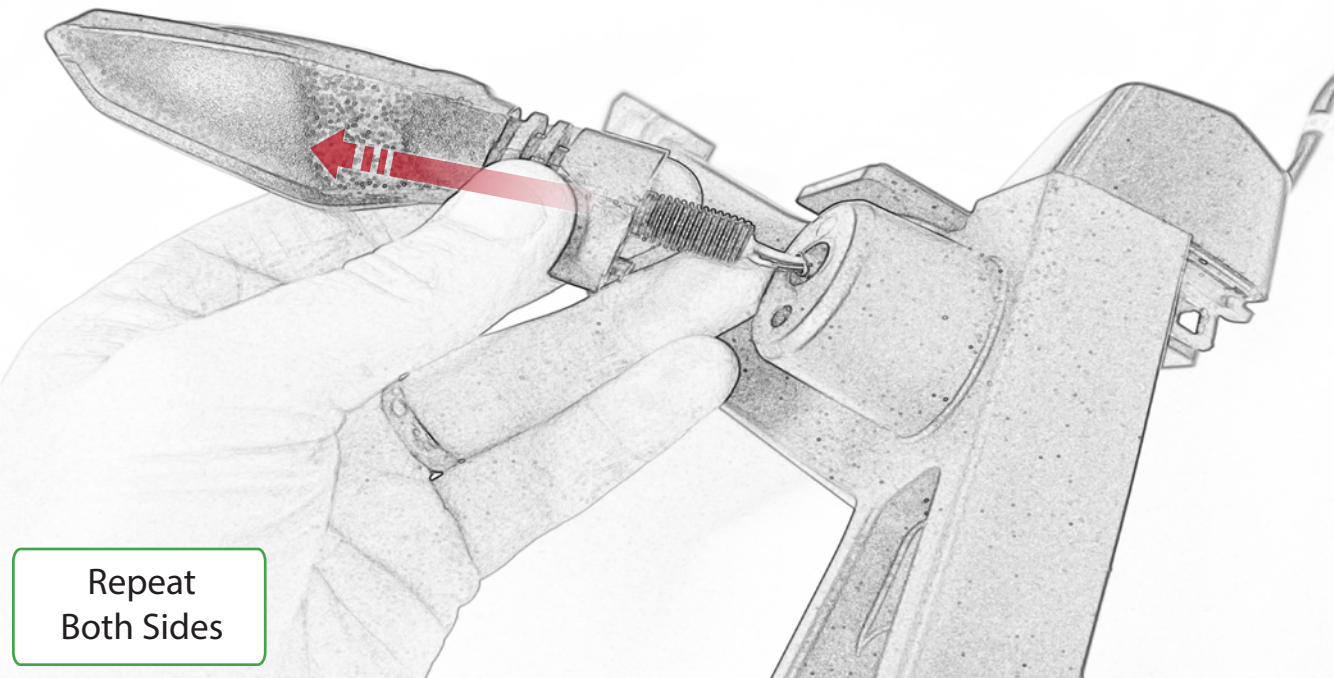

Repeat
Both Sides

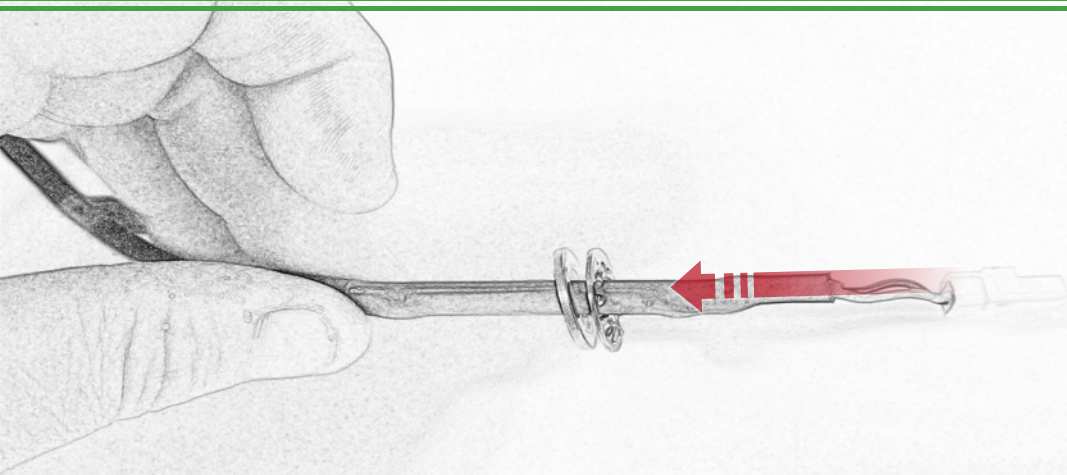

Repeat
Both Sides

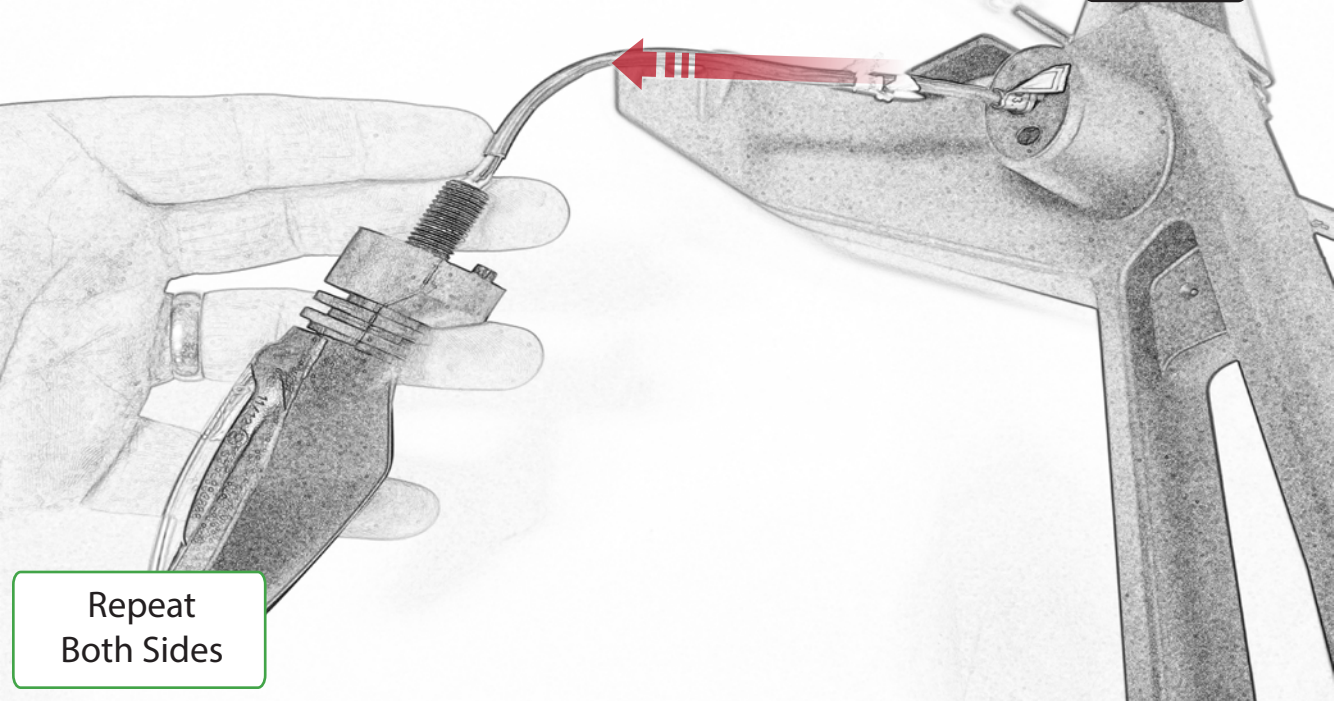

Repeat
Both Sides

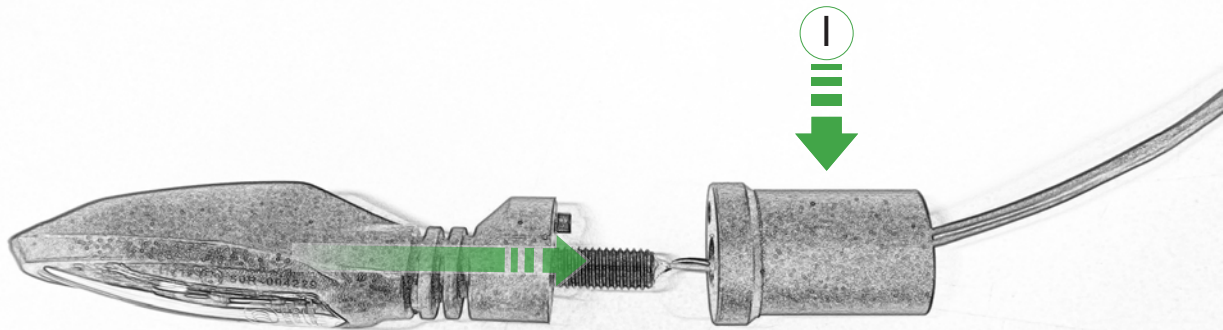

Repeat
Both Sides

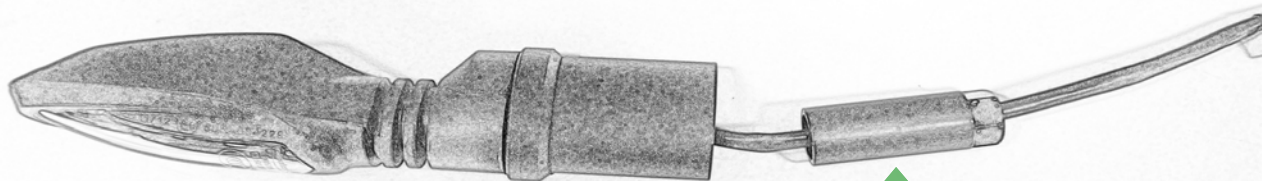

OEM PART

Repeat
Both Sides

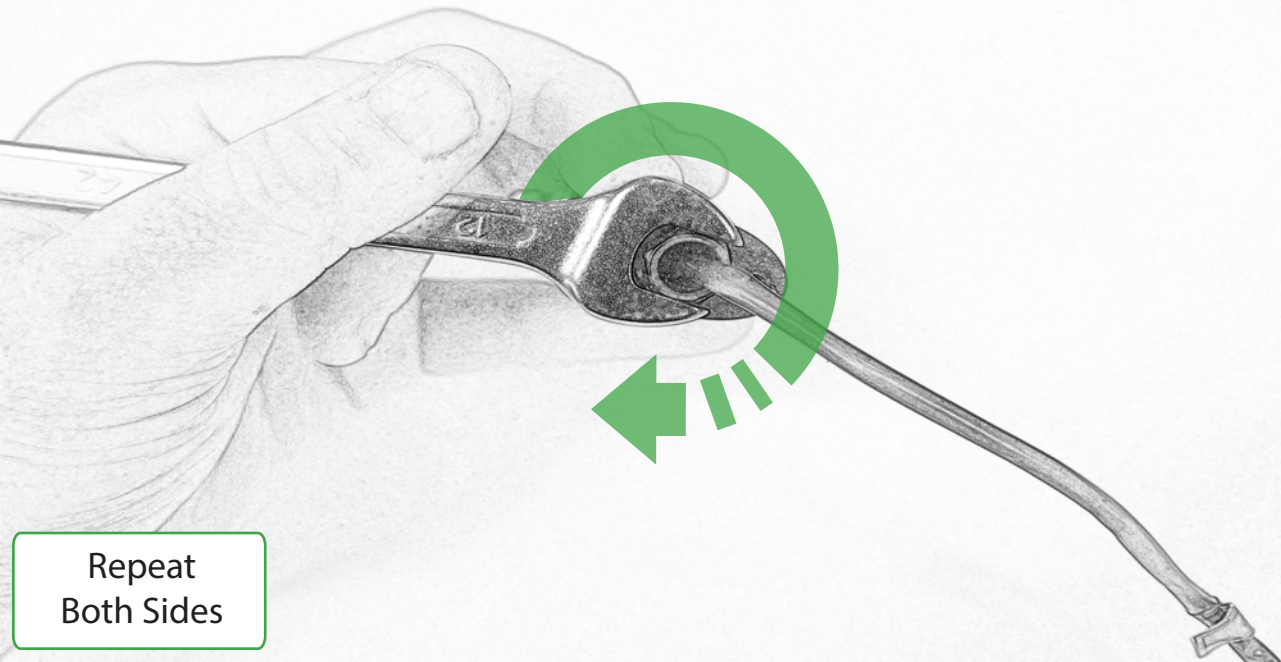

Repeat
Both Sides

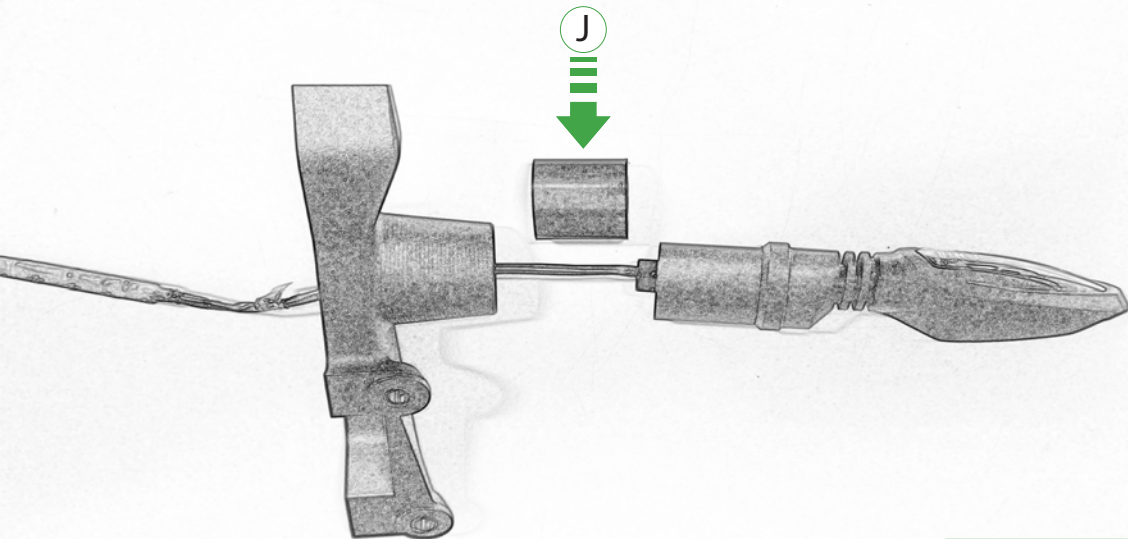

Repeat
Both Sides



J = Optional
For Wide Plates

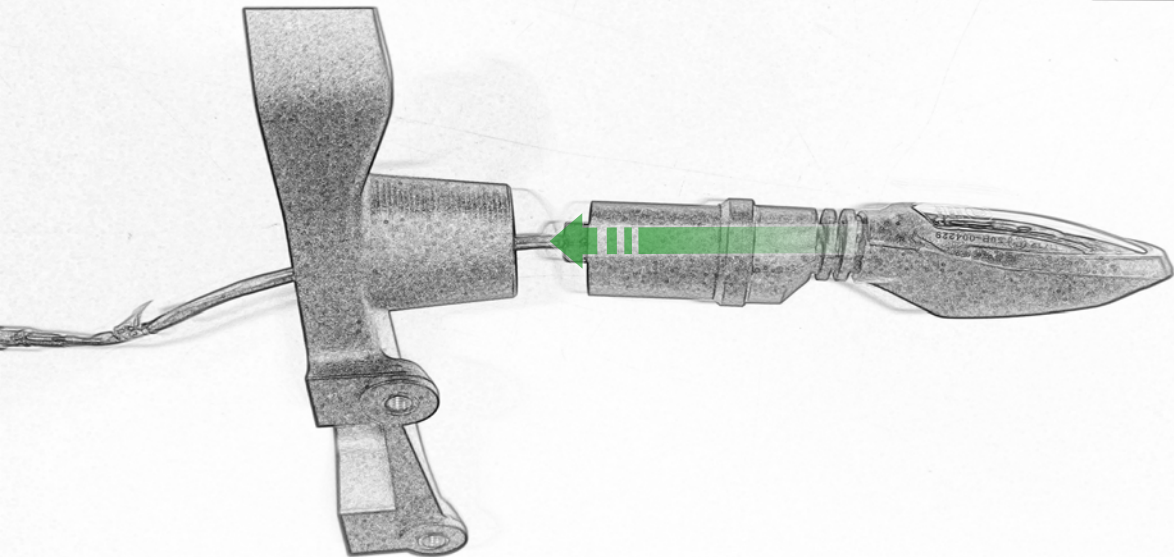

Repeat
Both Sides



Repeat
Both Sides

K = Extension Version
L = Standard Version

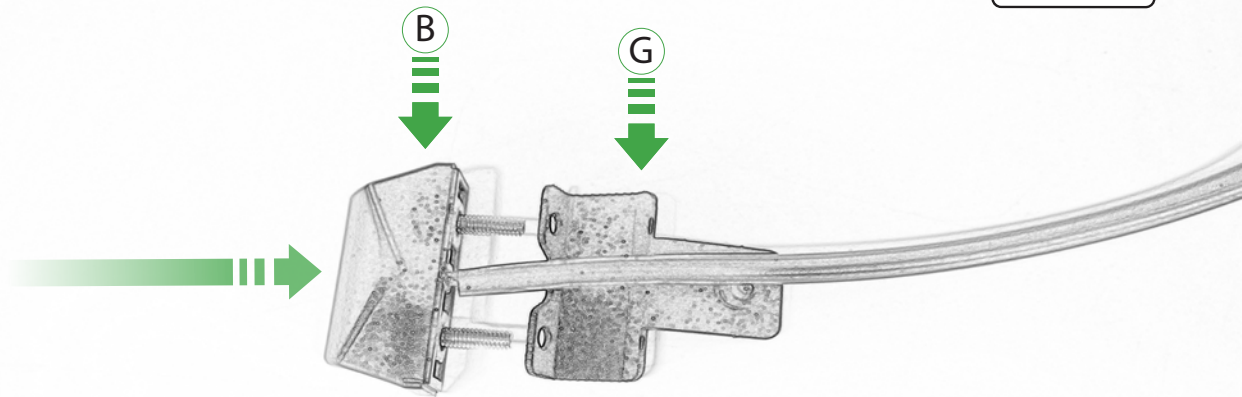

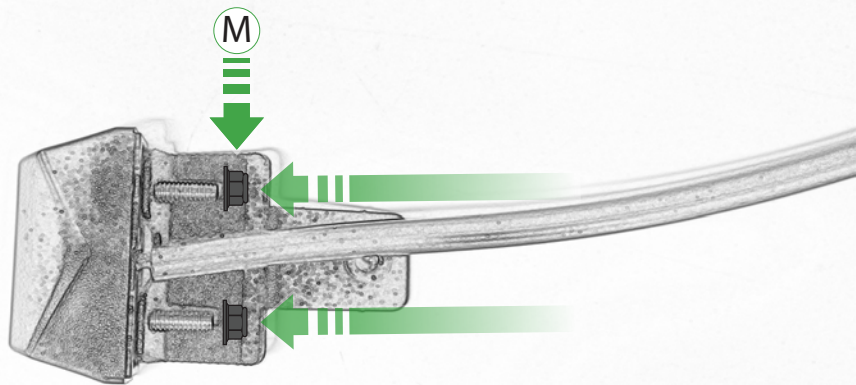

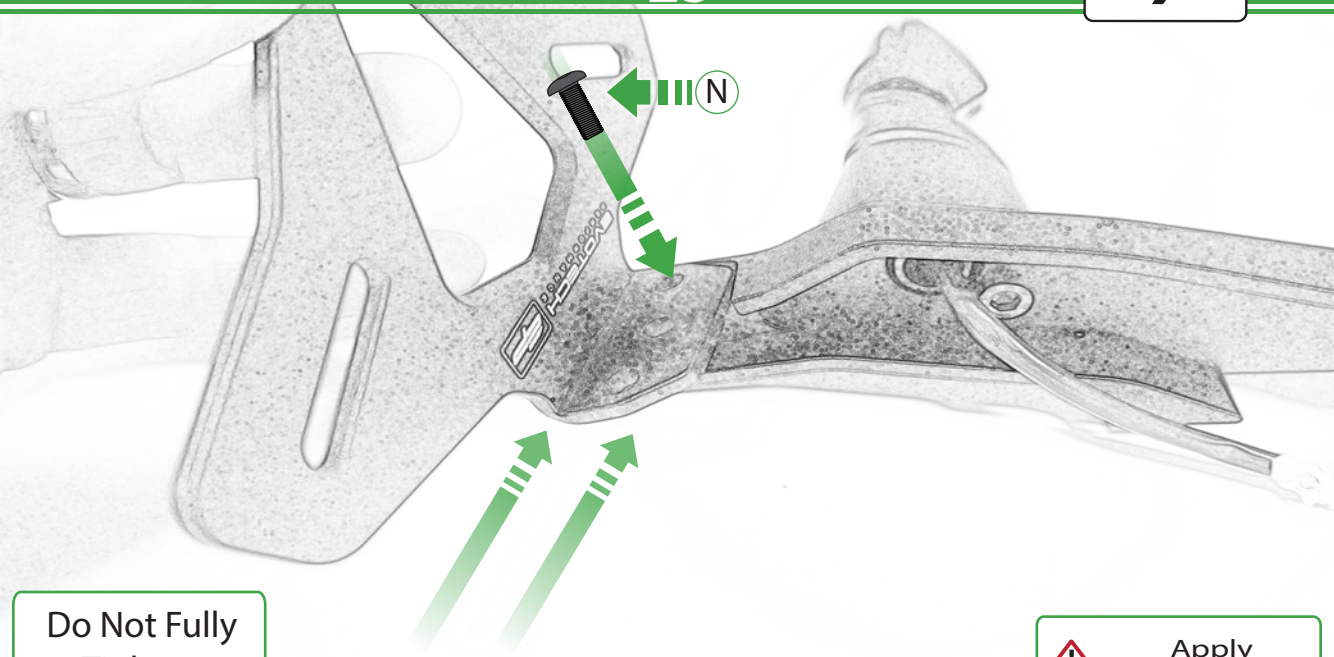

Do Not Fully Tighten

 Caution Apply Threadlock

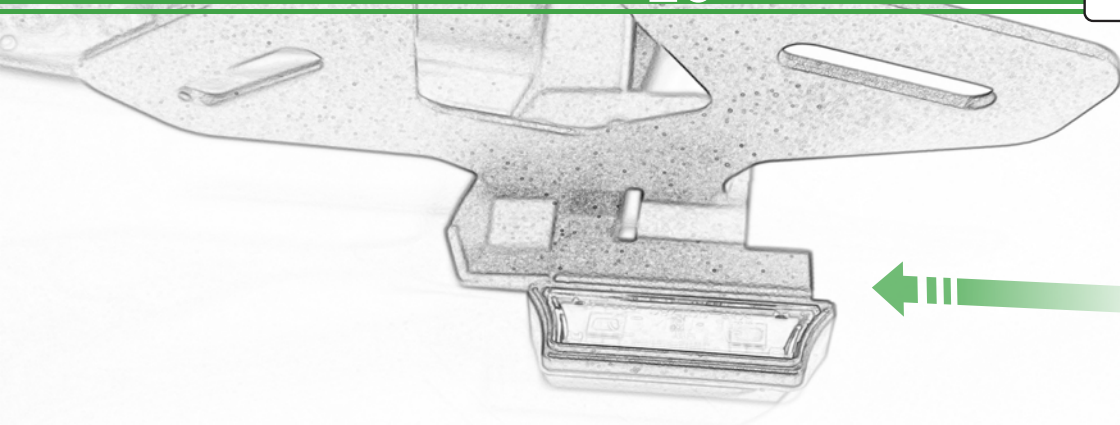

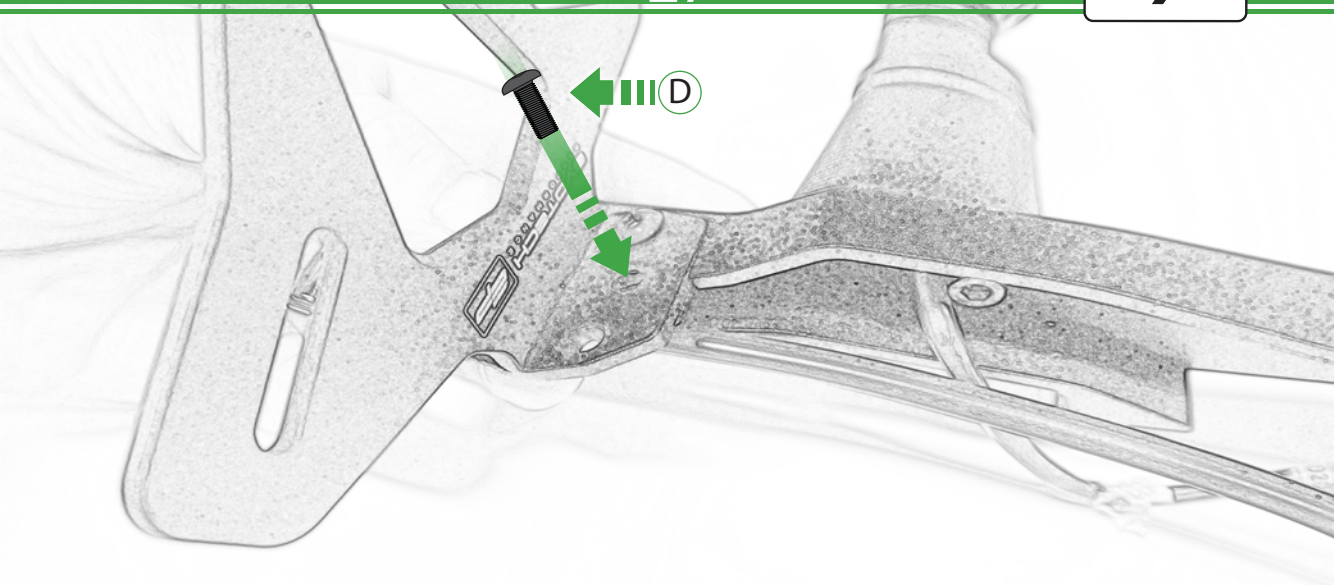

Do Not Fully Tighten



Caution

Apply Threadlock

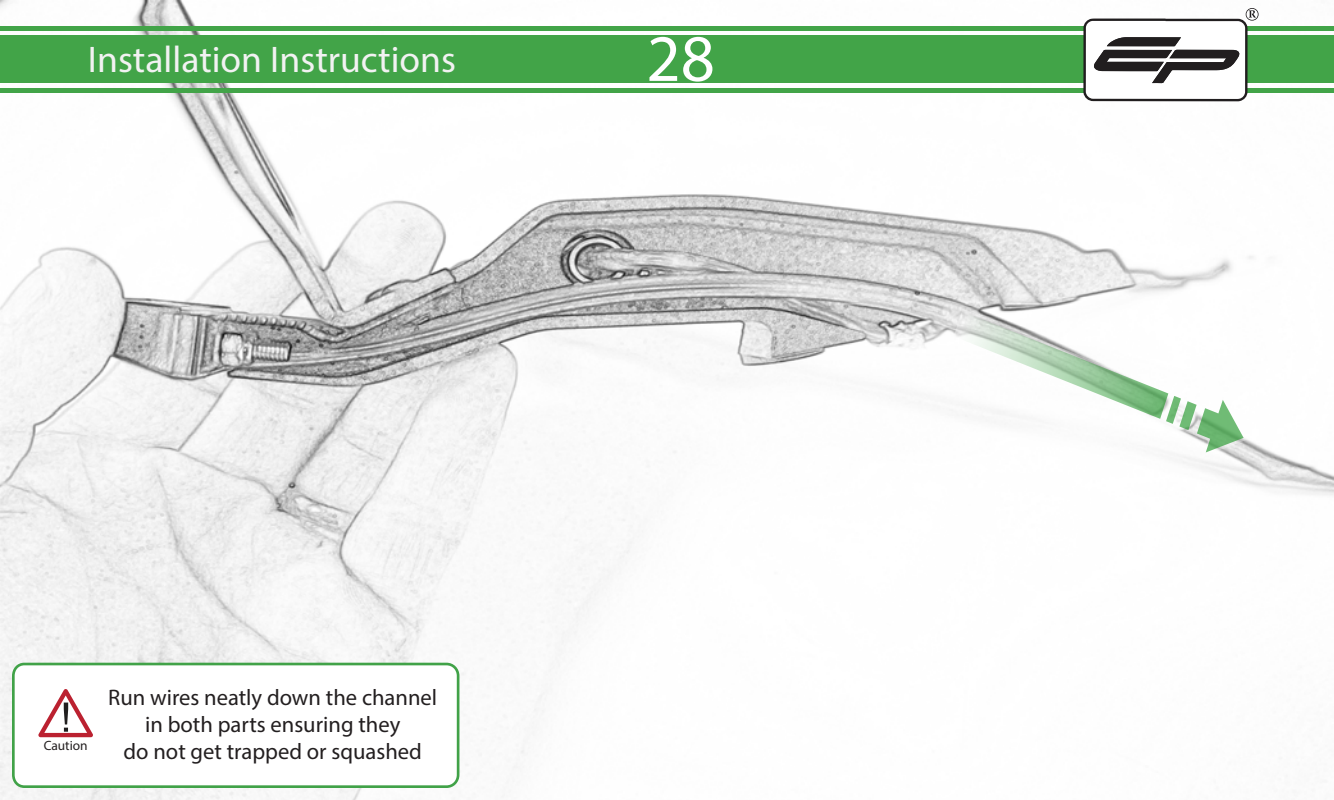

Caution

Run wires neatly down the channel in both parts ensuring they do not get trapped or squashed

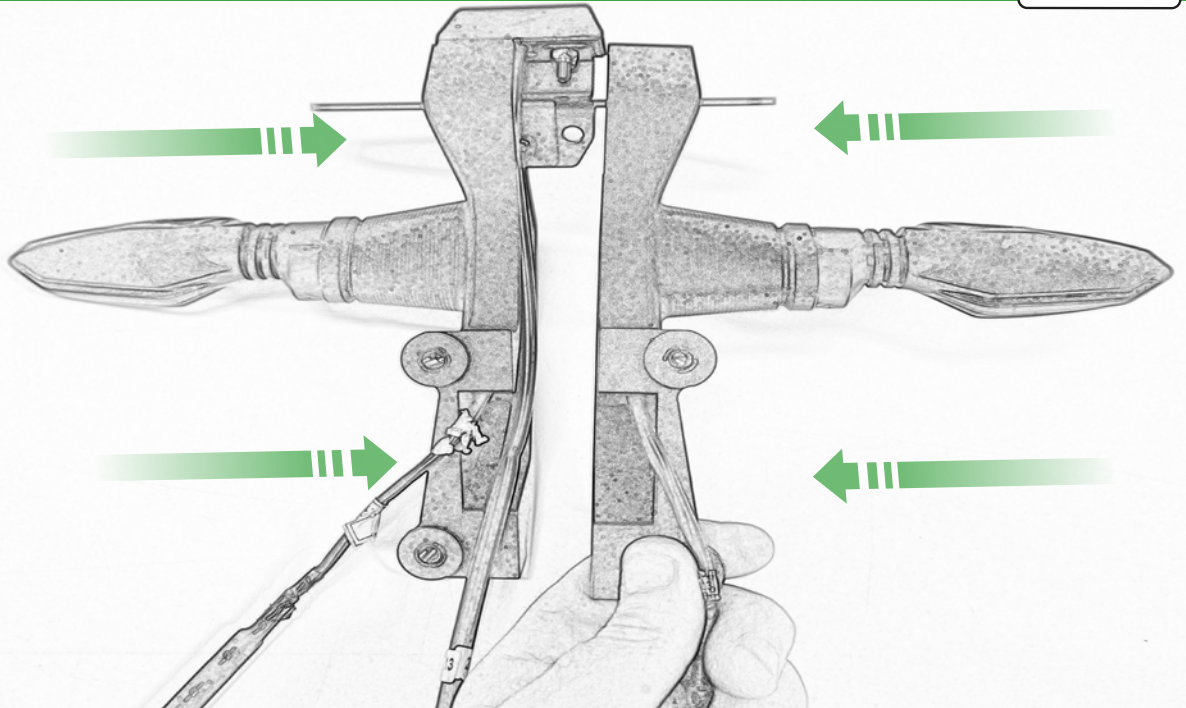

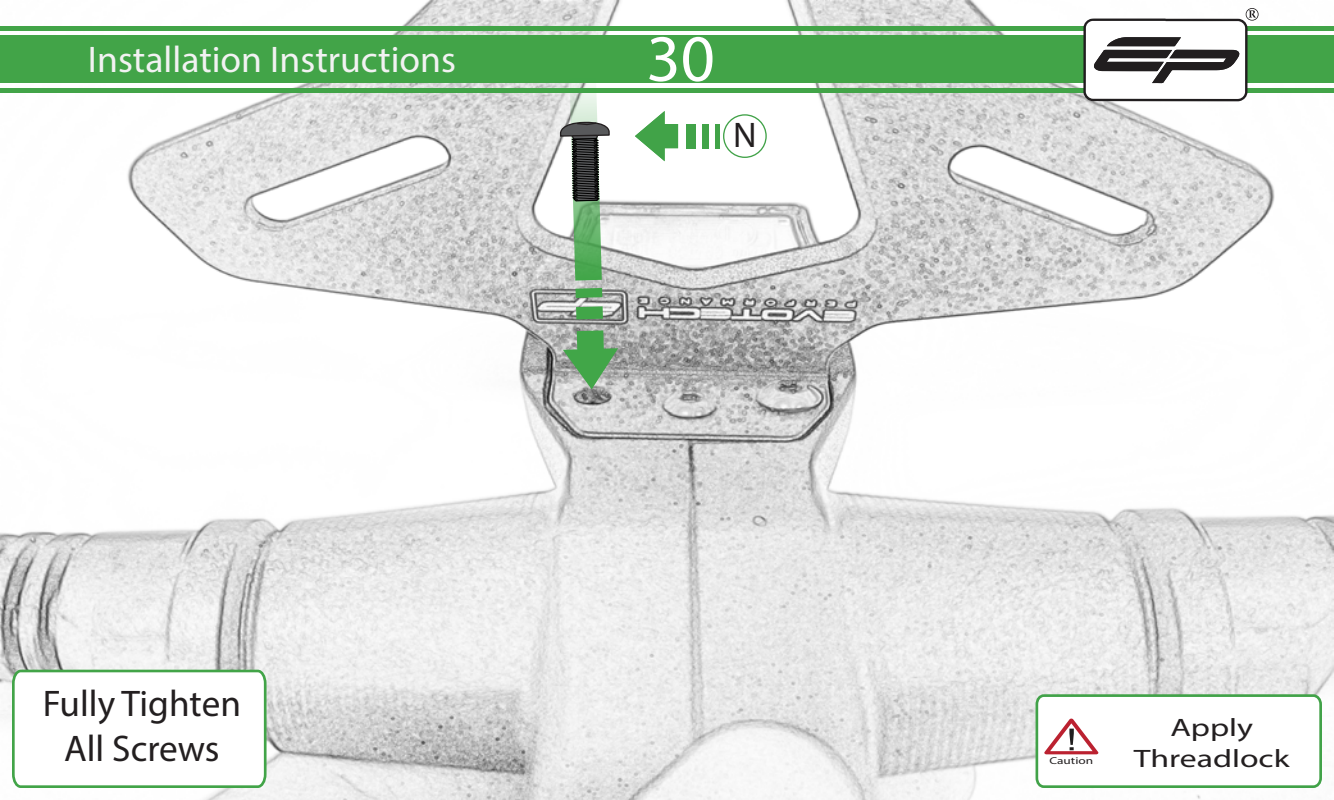

Fully Tighten
All Screws



Caution

Apply
Threadlock

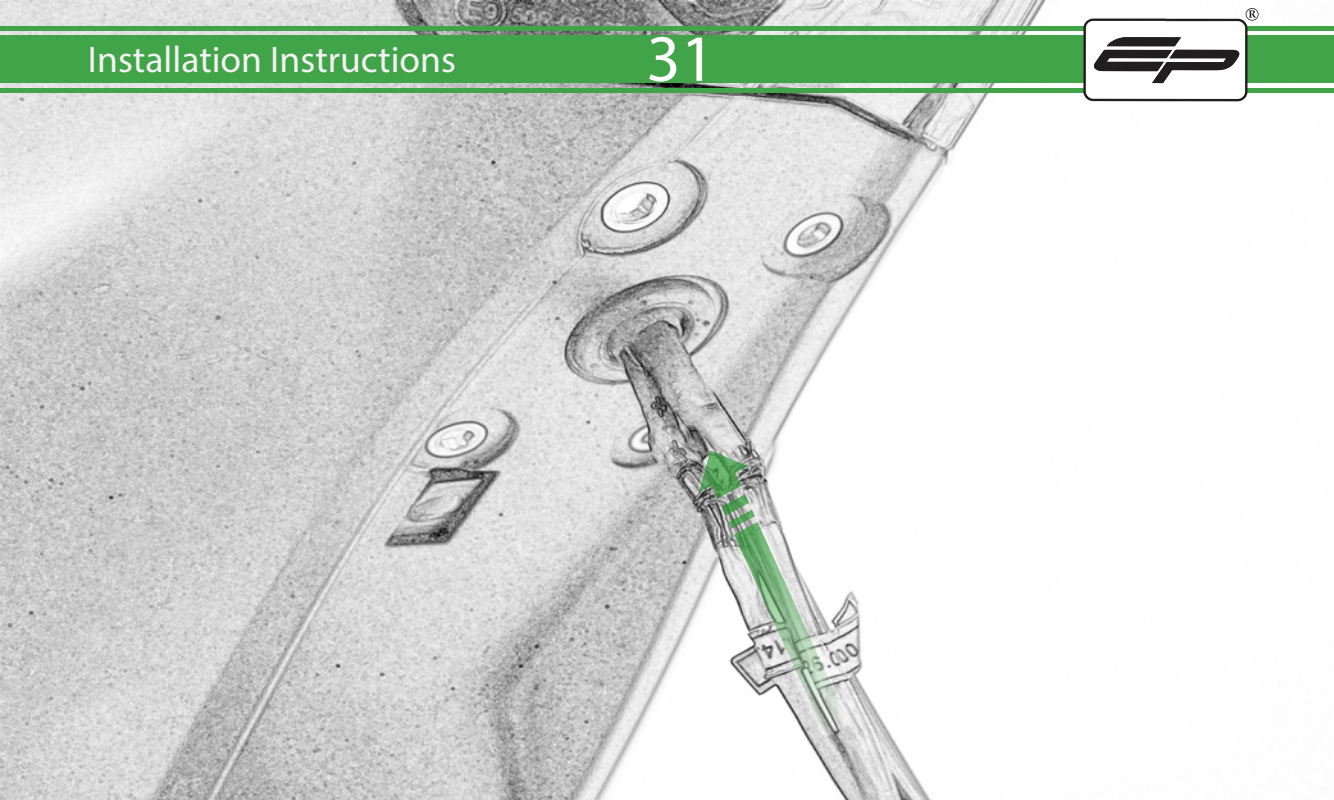

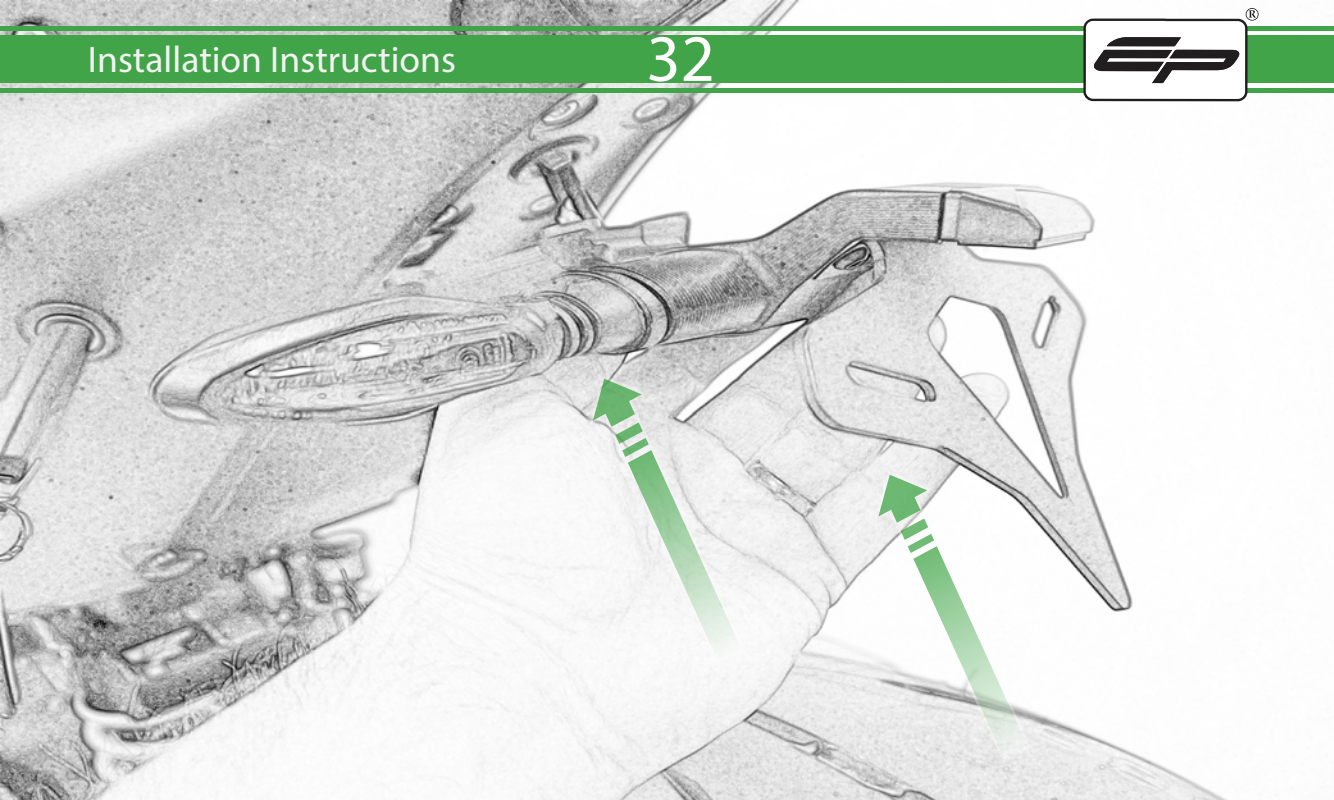

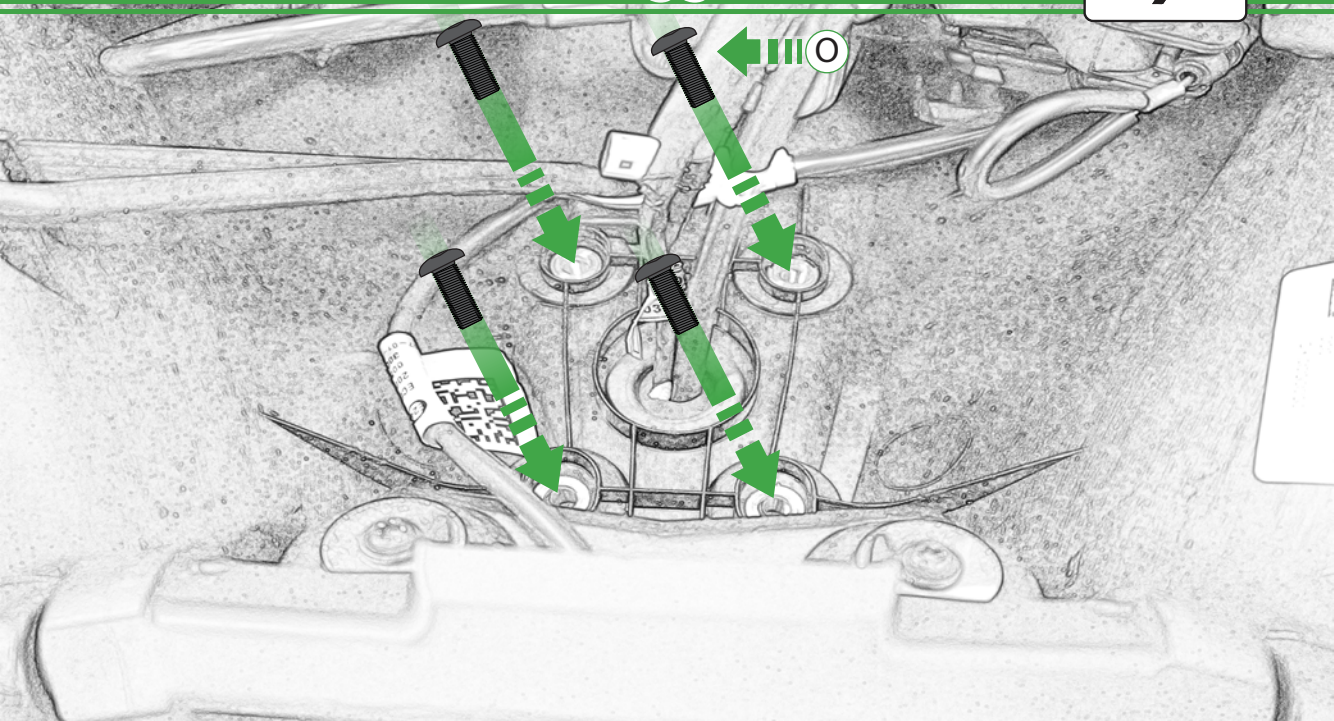

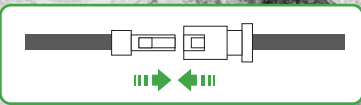
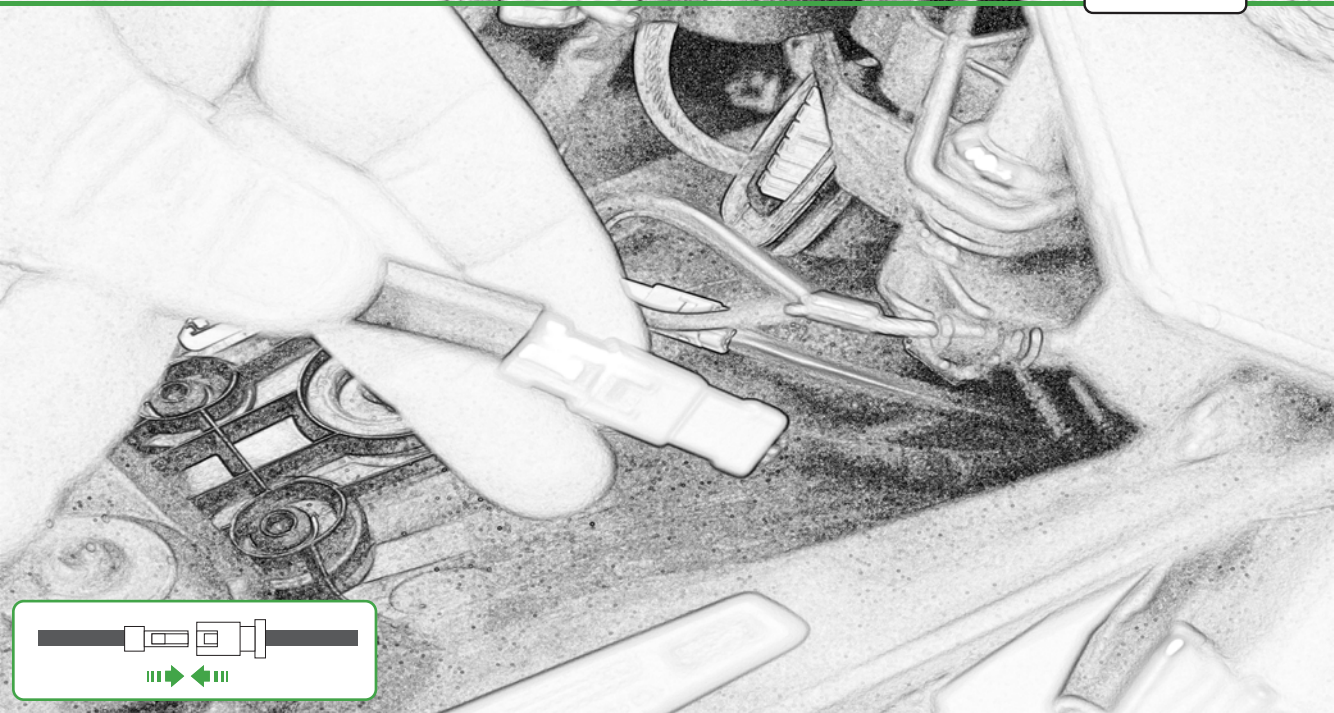

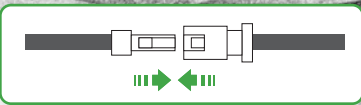
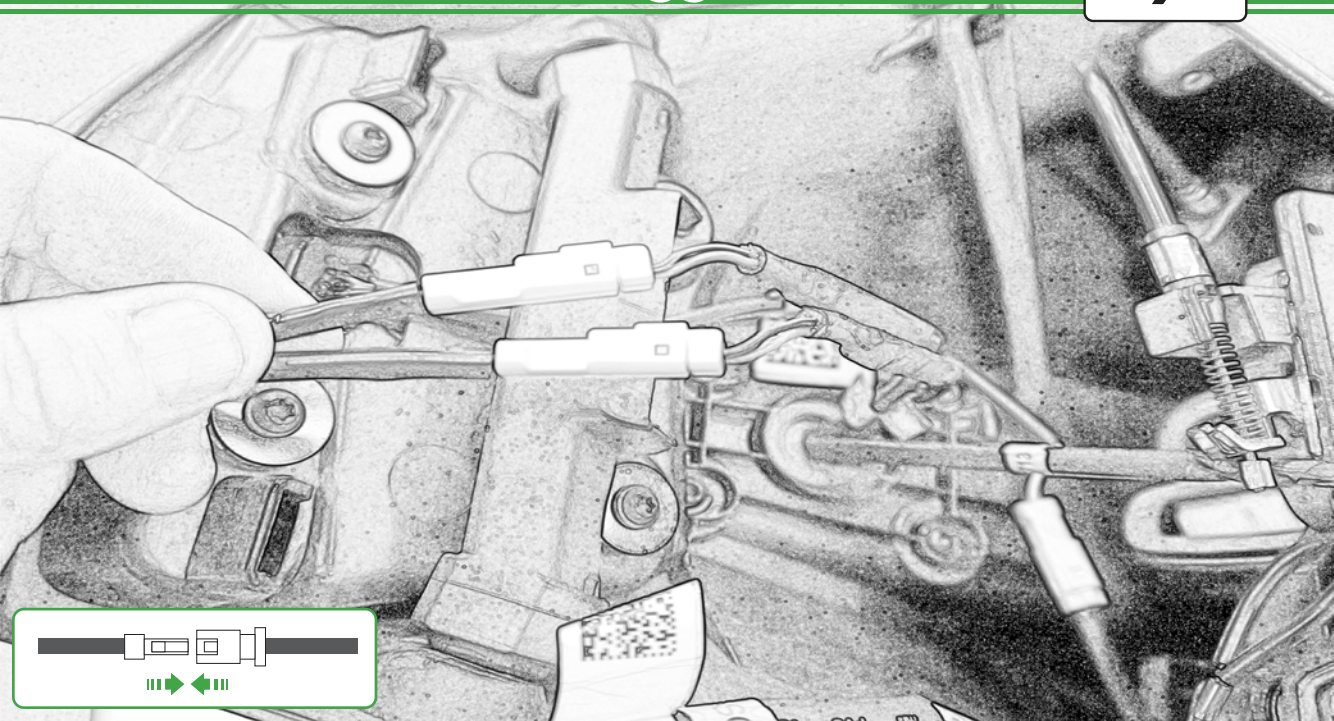

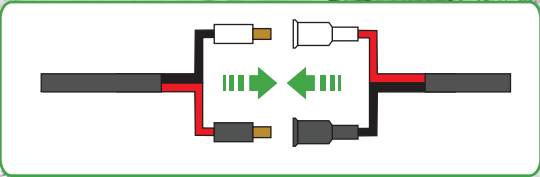
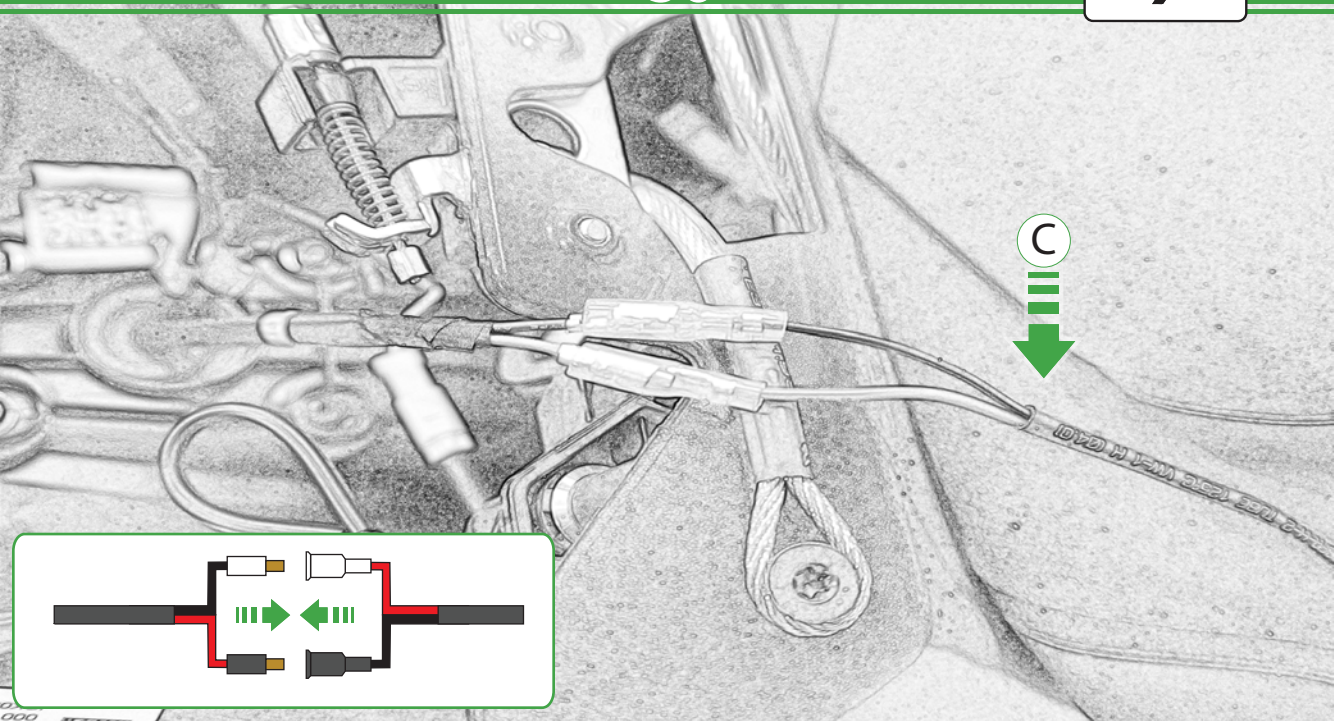

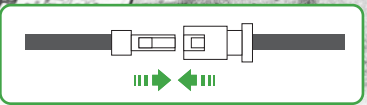
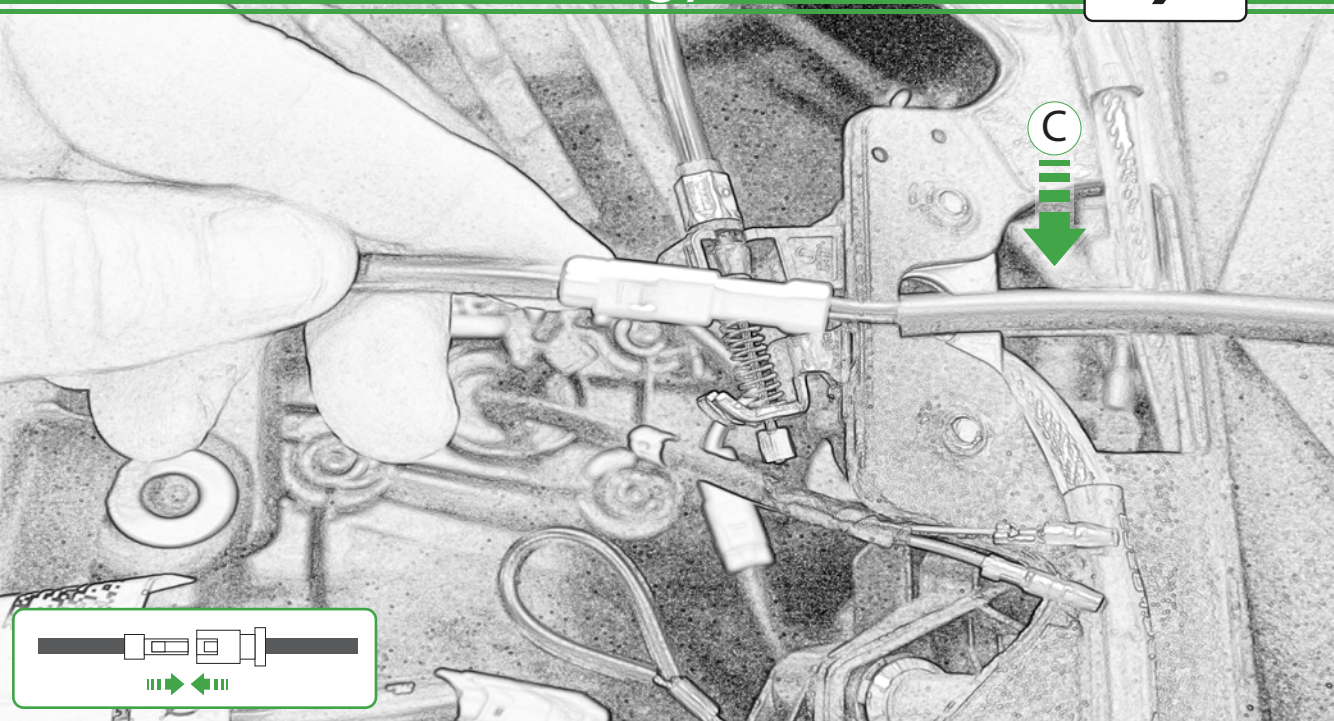

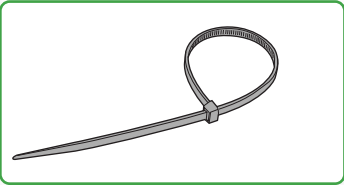
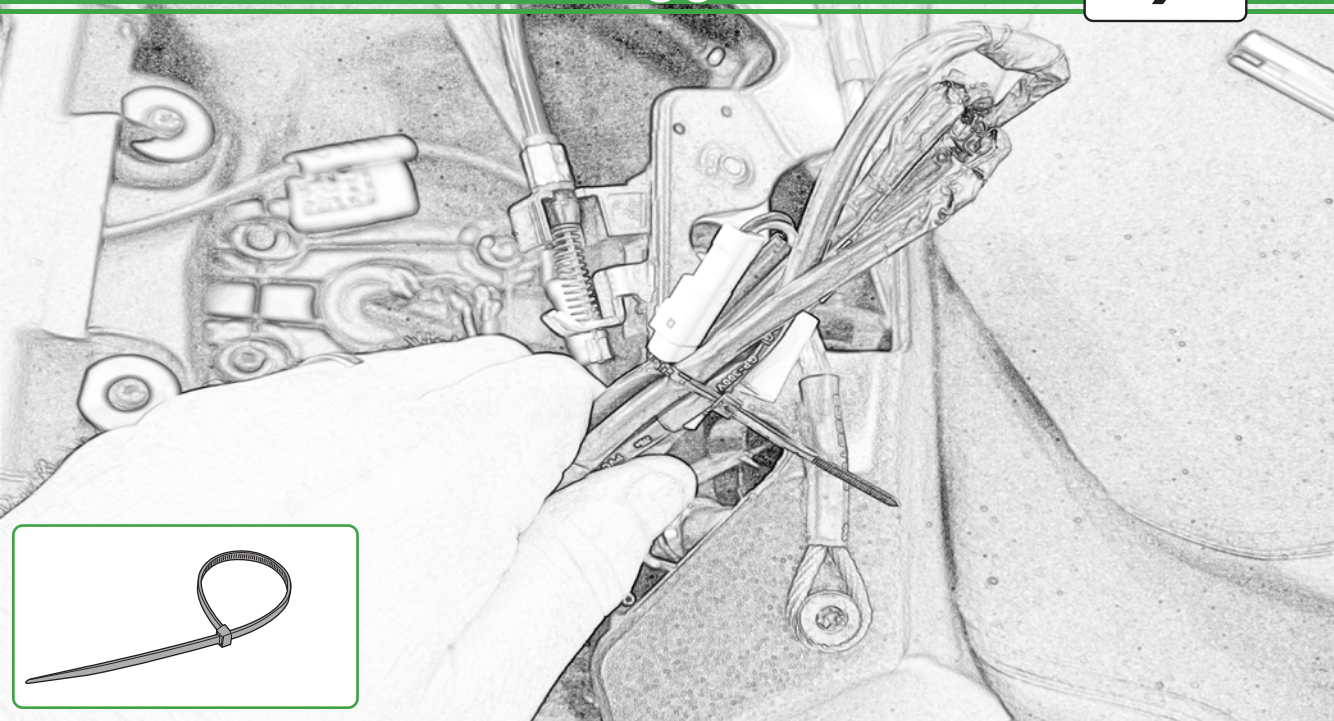

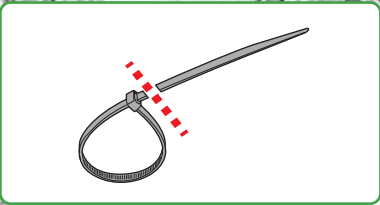
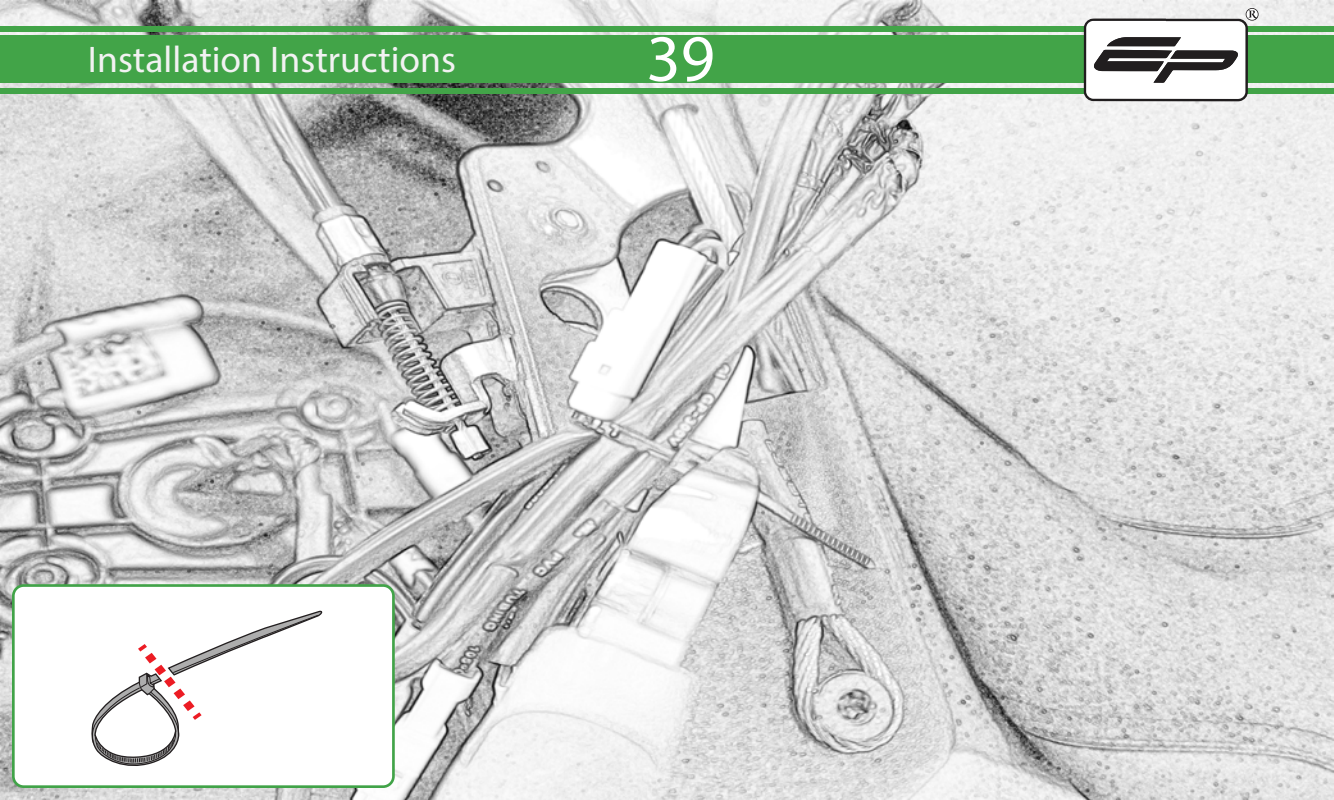

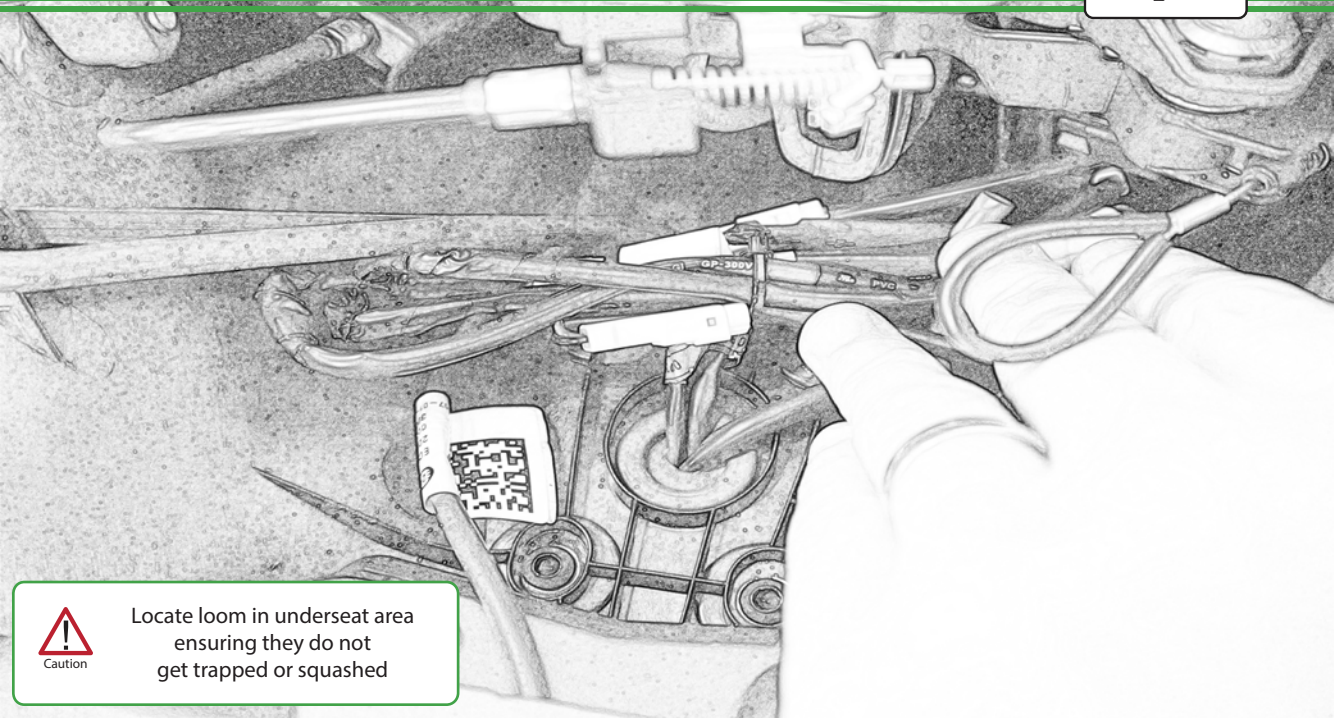

Caution

Locate loom in underseat area ensuring they do not get trapped or squashed

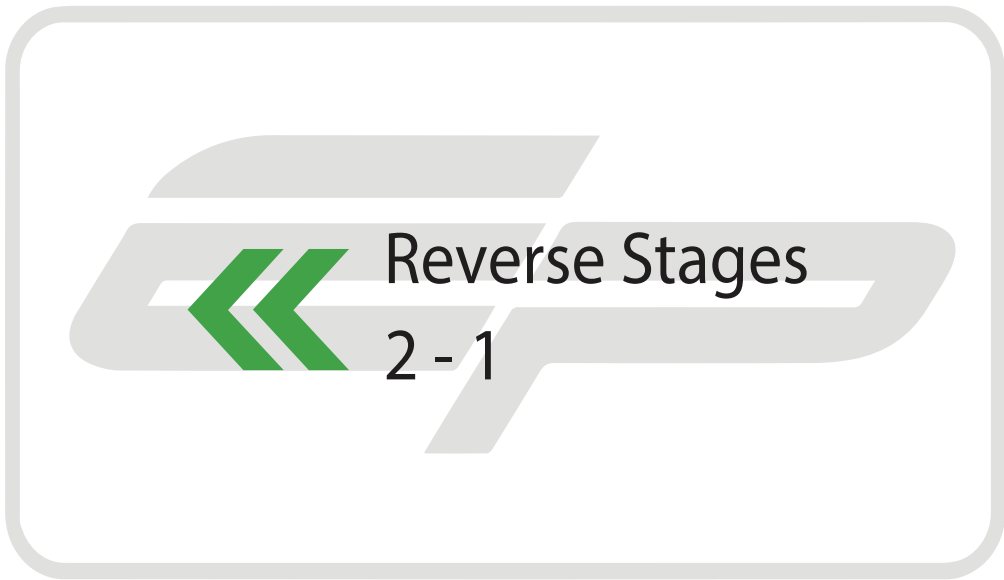

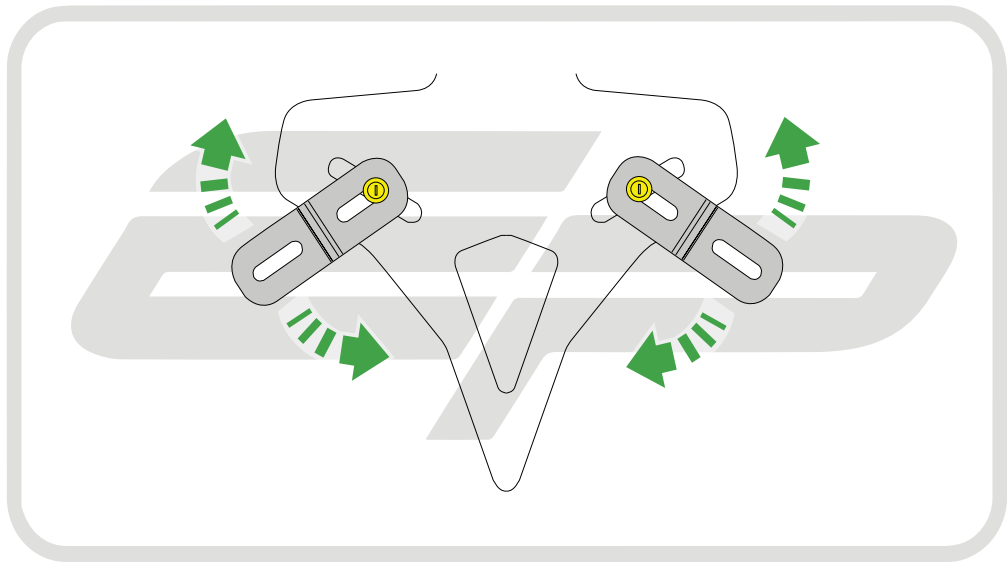

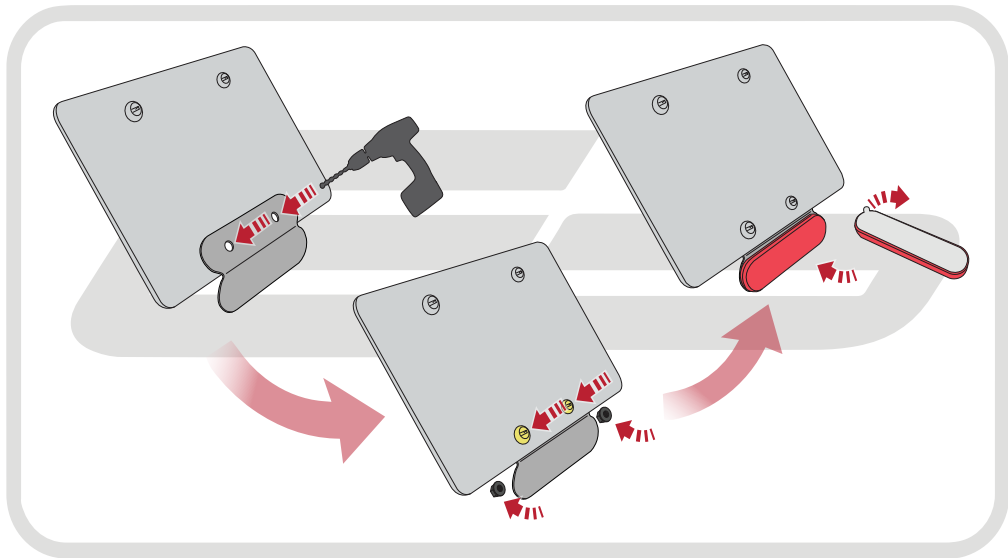



EVOTECH®
P E R F O R M A N C E

www.evotech-performance.com