



For SP Connect mirco stem mount alu Part number #53122

For SP Connect anti vibration module Part number #53135



## Kit Contents

- (A) 1 x Pivot Plate
- (B) 1 x Main Bracket
- (C) 1 x M6 x 16 Countersunk Screw
- (D) 1 x SP Connect Plate
- (E) 1 x M5 Nylock Nut
- (F) 2 x M5 x 10mm Caphead Bolt
- (G) 2 x Spacer
- (H) 2 x M5 x 12 Caphead Bolt
- (I) 2 x M8 Caphead Bolt
- (J) 2 x Nord Washer

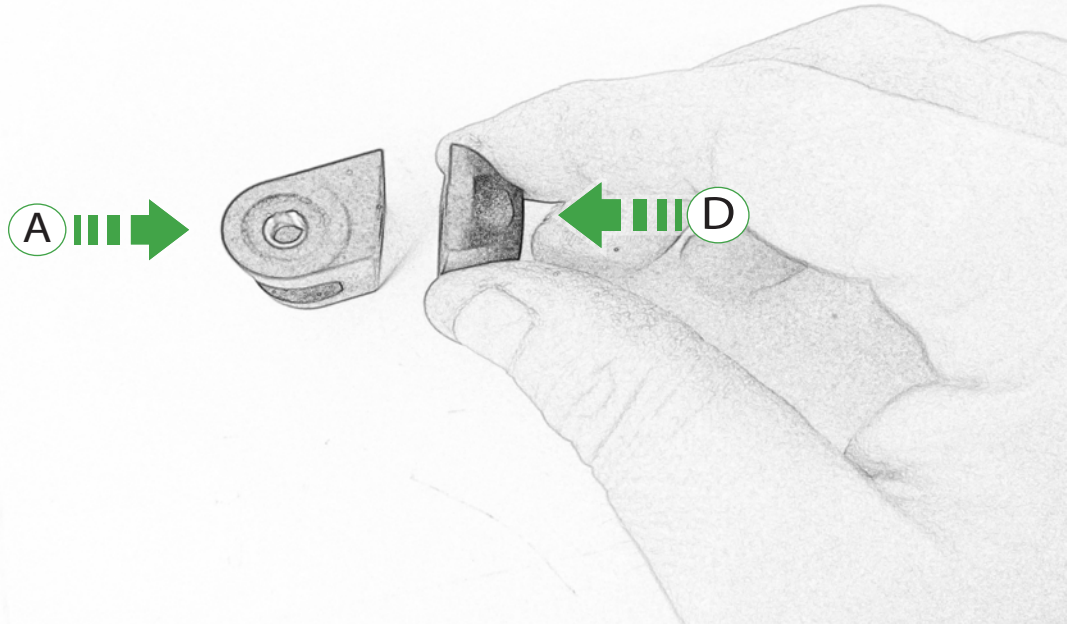

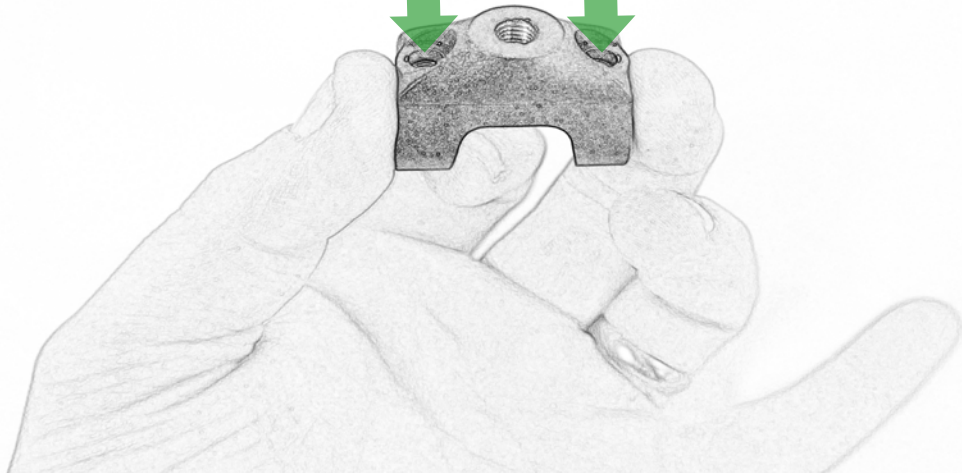
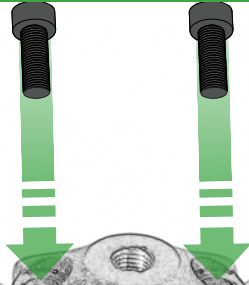

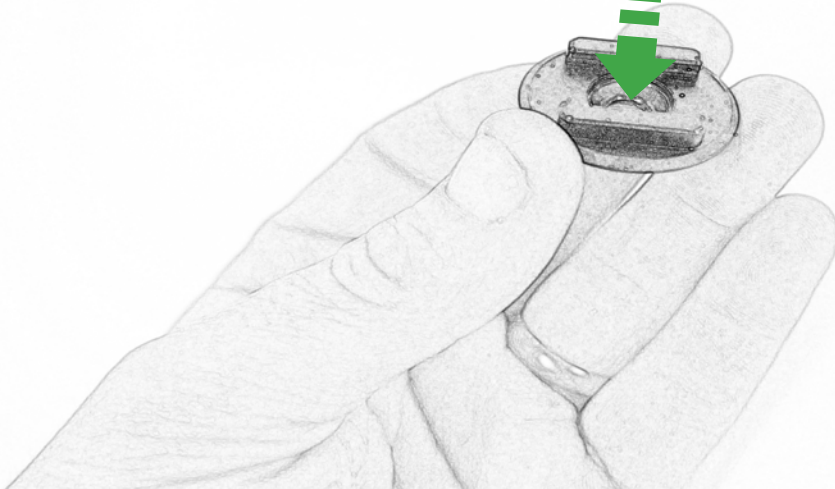
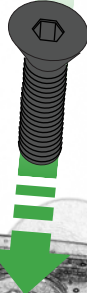

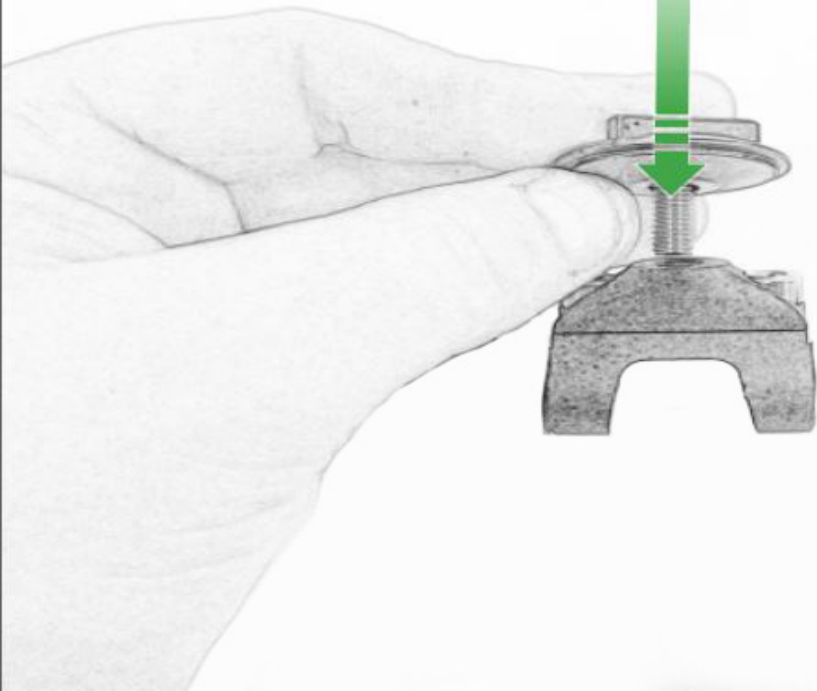

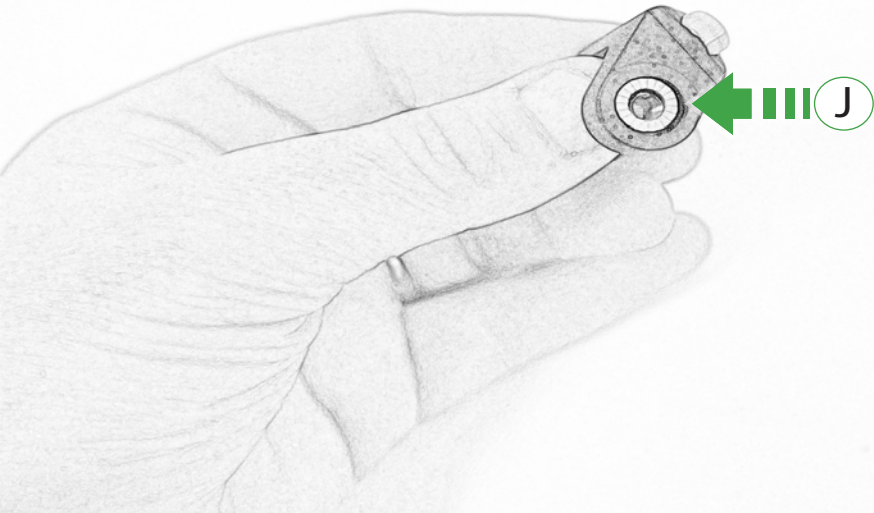

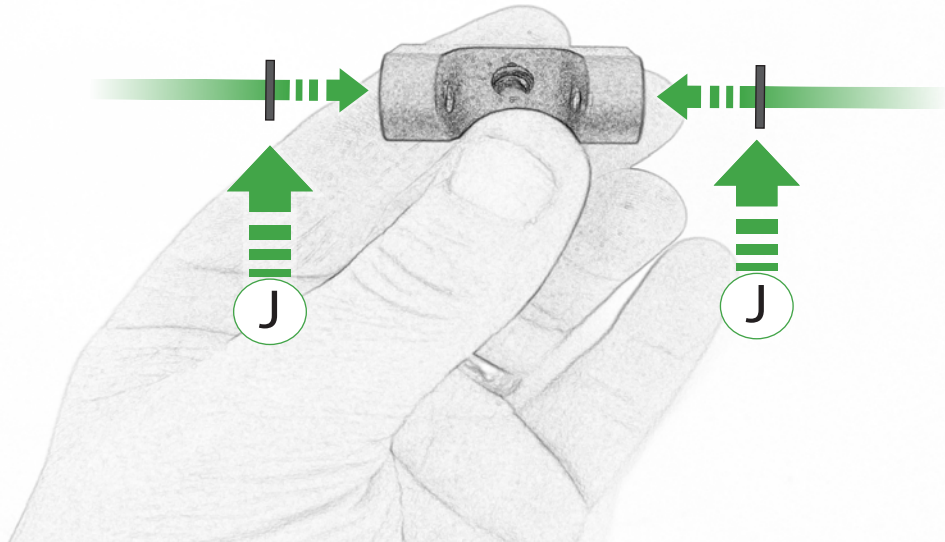





For SP Connect anti vibration module Part number #53135

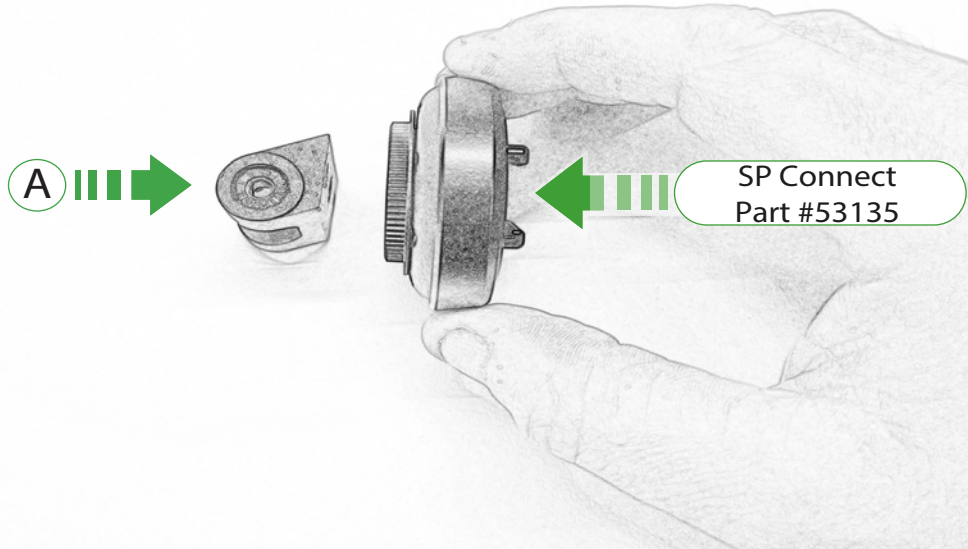

A

SP Connect  
Part #53135



Supplied with  
#53135

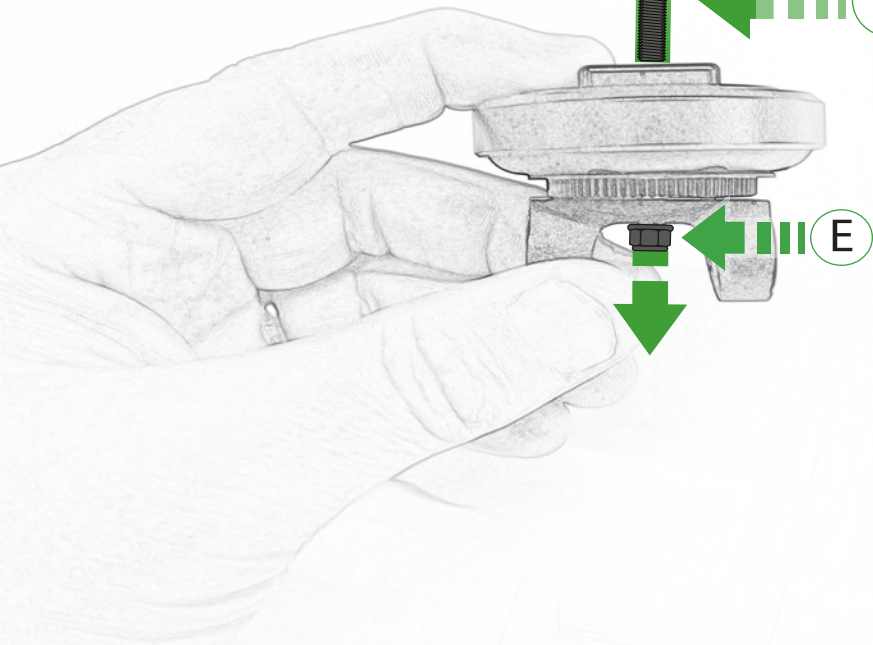

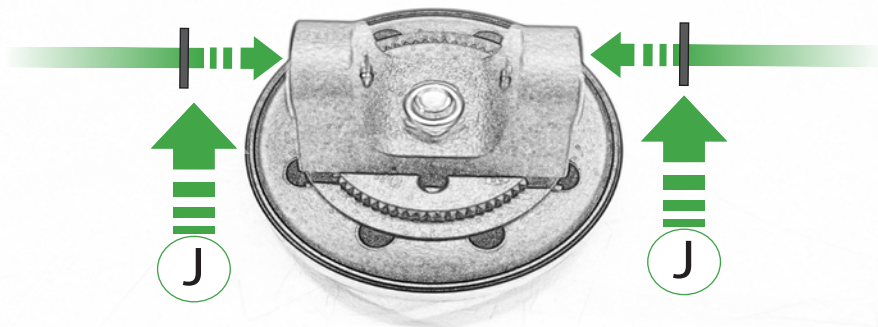

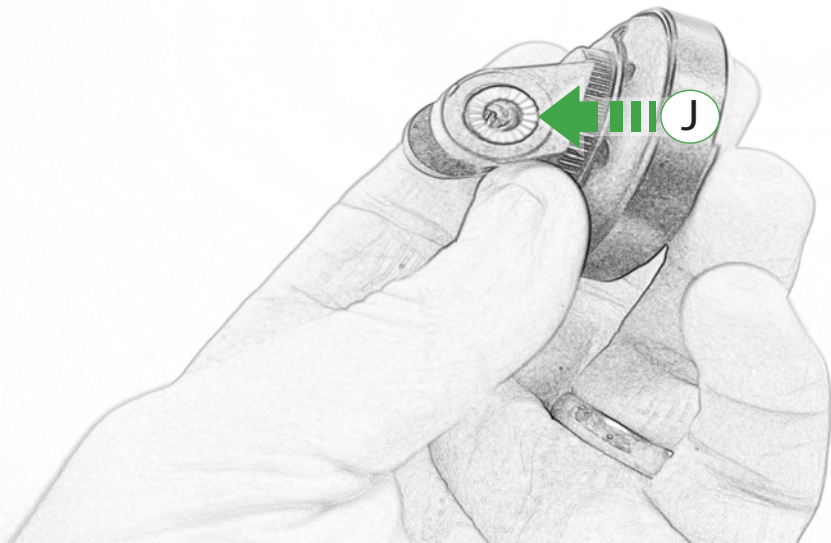

Repeat  
Both Sides

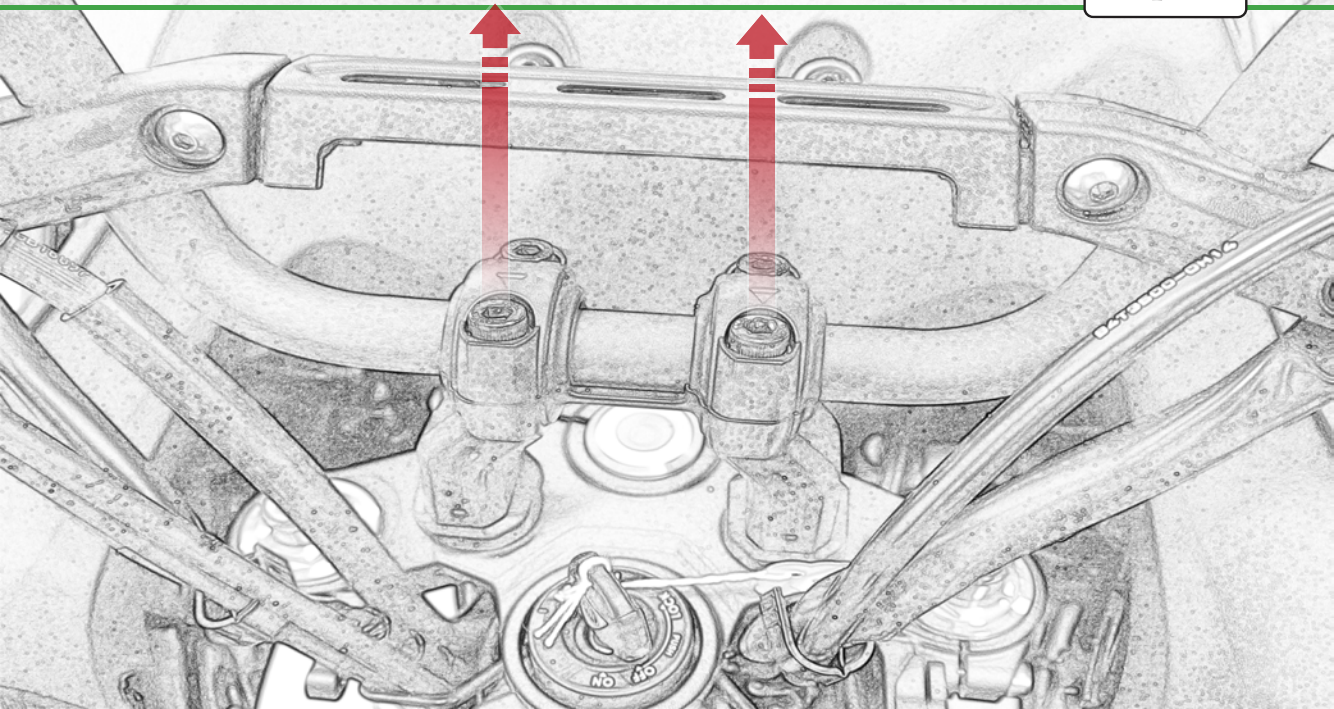

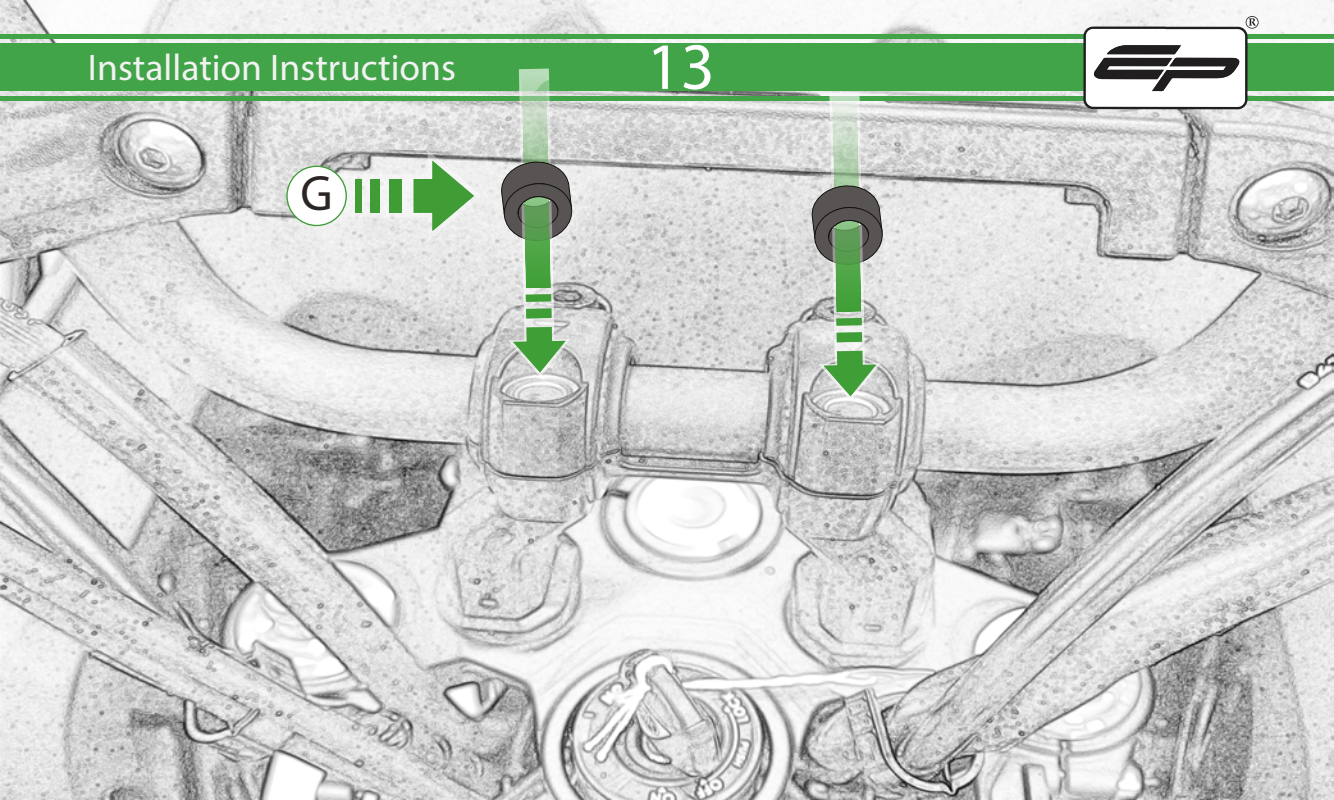







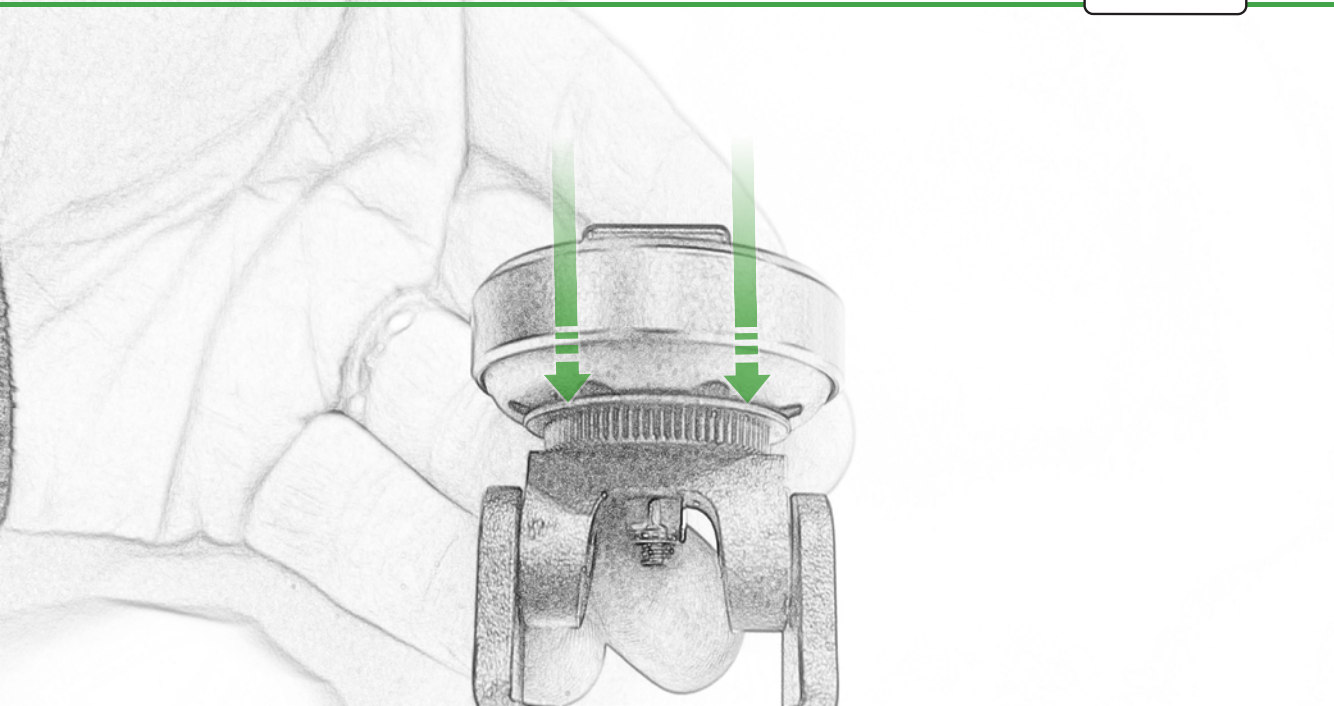

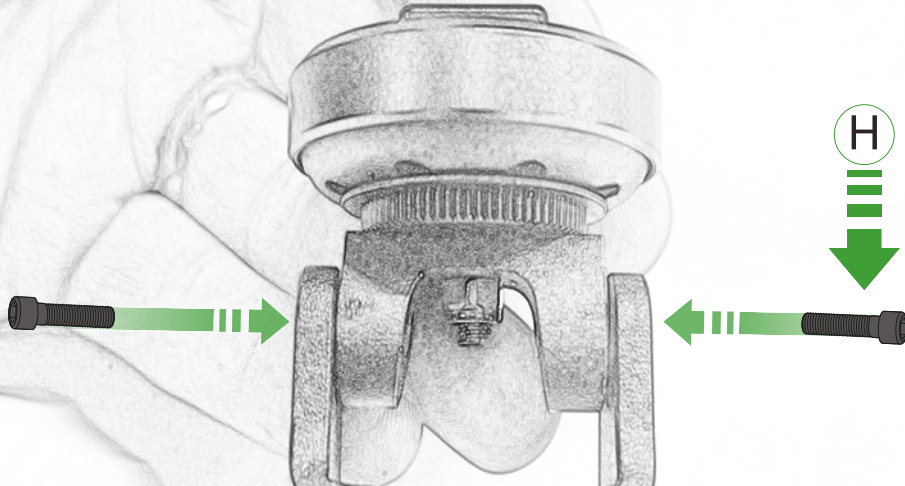

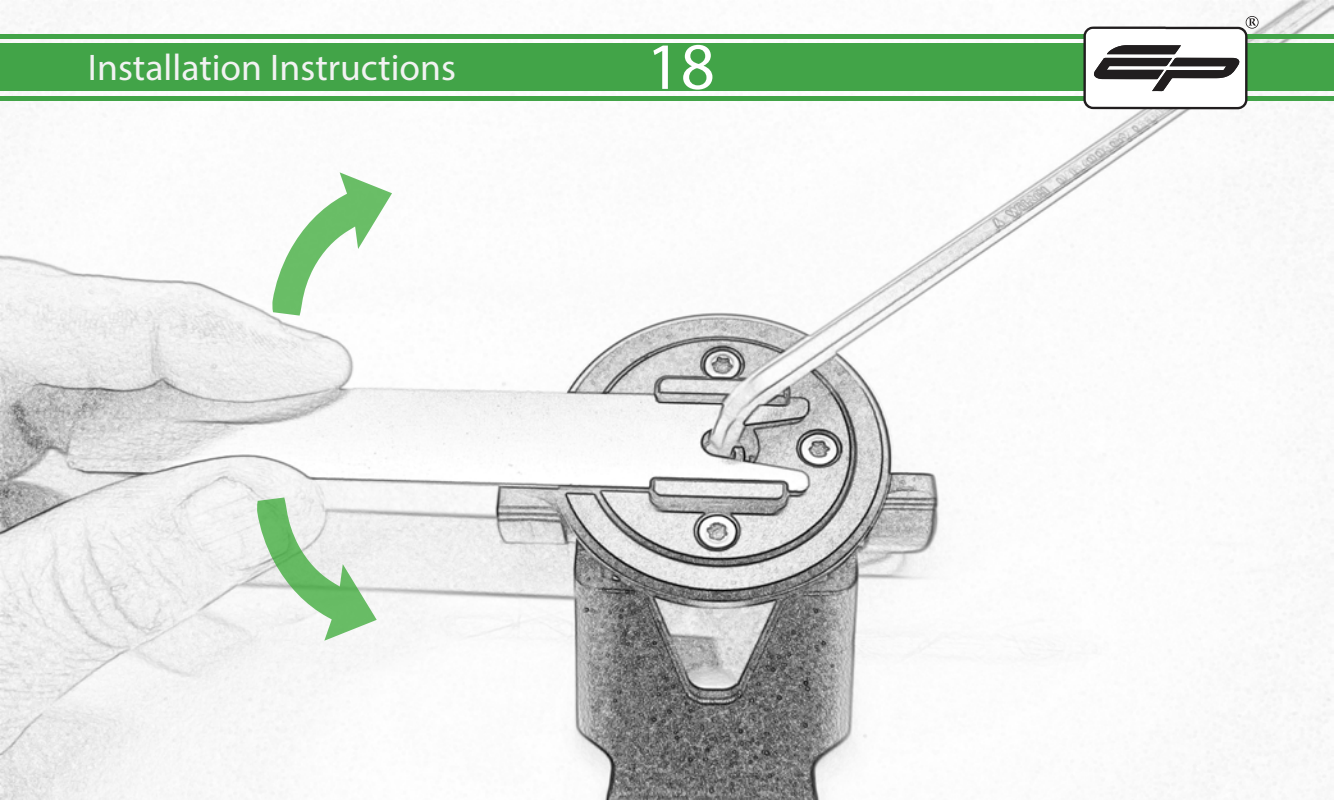



## ESSENTIAL CHECKS



It is recommended that periodic inspections are made to ensure that all bolts are tightened to the specified torque settings.

Should the bike be involved in an accident a thorough inspection should be made and any components that have taken an impact, no matter how small, be replaced