



**EVOTECH**®  
P E R F O R M A N C E

BMW F 900 XR / TE

SP Connect Sat Nav Mount

Installation Instructions



For SP Connect mirco stem mount alu Part number #53122  
follow instructions 1 - 24

For SP Connect anti vibration module Part number #53135  
follow instructions 25 - 46



## Kit Contents PRN014677-015019

- |                                   |                                     |
|-----------------------------------|-------------------------------------|
| (A) 1 x M6 x 16 Countersunk Screw | (L) 2 x M5 Black Washer             |
| (B) 1 x Pivot Plate               | (M) 2 x M4 x 5mm Button Head Bolts  |
| (C) 1 x SP Connect Plate          |                                     |
| (D) 1 x Spanner                   | Sub Kit                             |
| (E) 2 x M5 x 10mm Caphead Bolts   | (N) 4 x M6 x 40 Caphead             |
| (F) 2 x P-clips (No.1)            | (O) 4 x M5 x 10mm Button Head Bolts |
| (G) 2 x P-clips (No.2)            | (P) 1 x M5 Nyloc Nut                |
| (H) 2 x P-clips (No.3)            |                                     |
| (I) 2 x P-clips (No.4)            |                                     |
| (J) 2 x Lobe Screw                |                                     |
| (K) 2 x Locking Washer            |                                     |

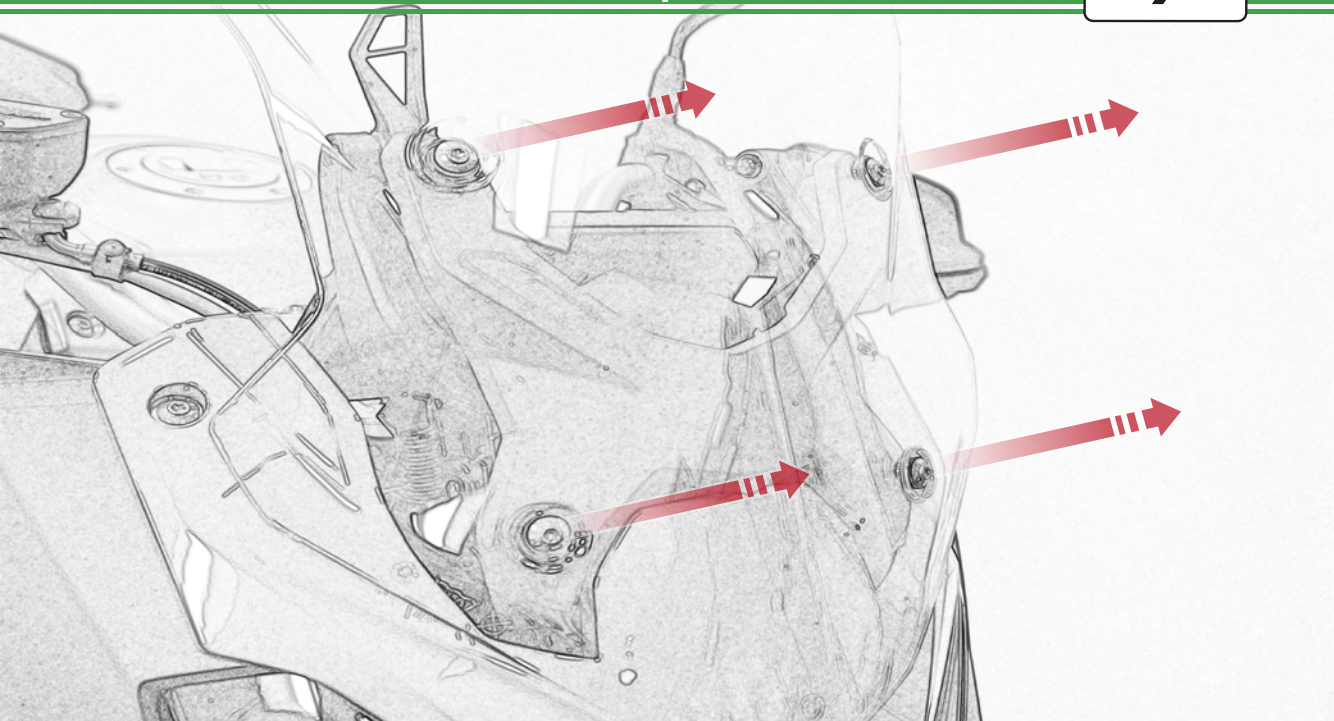





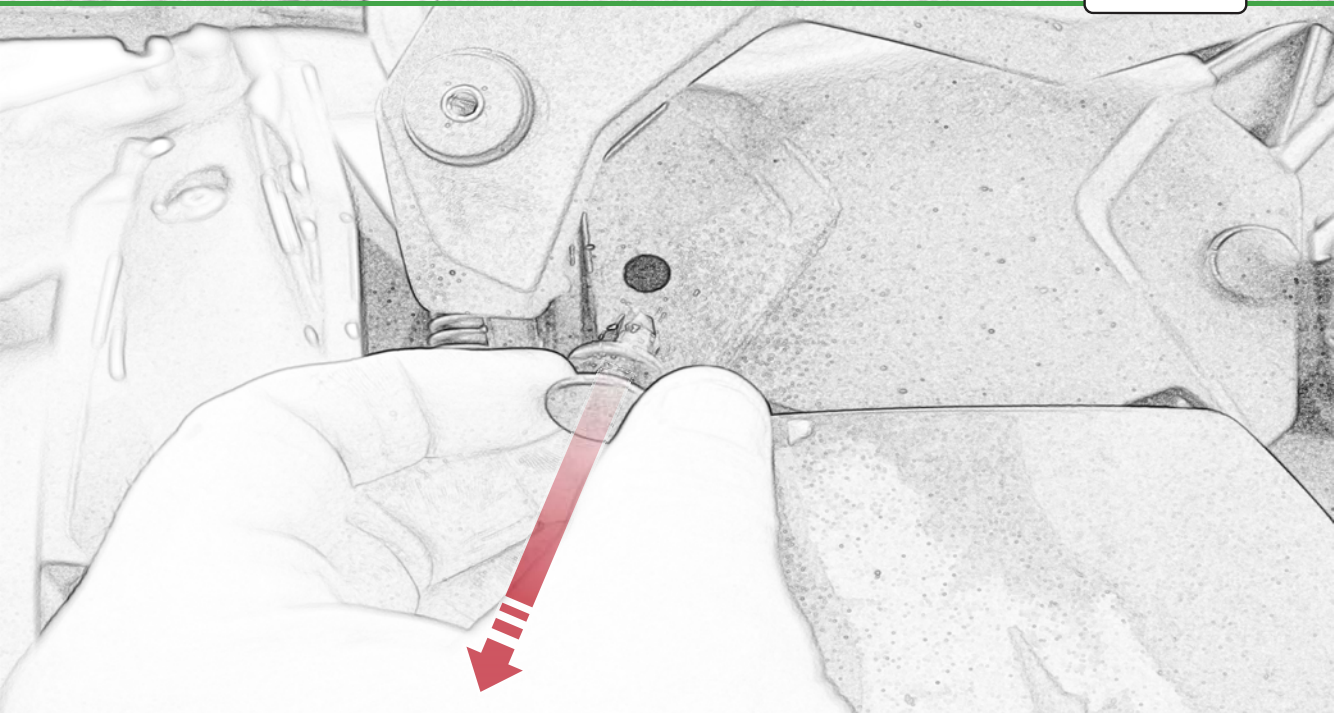

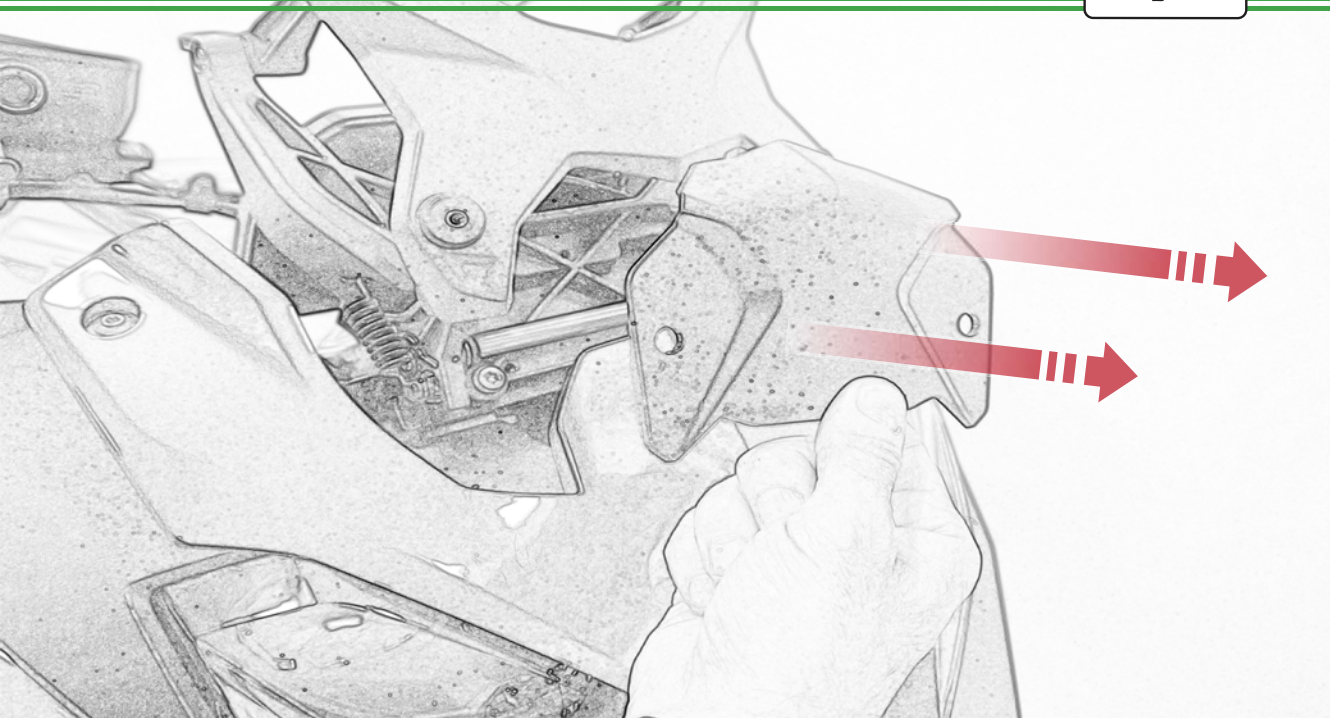



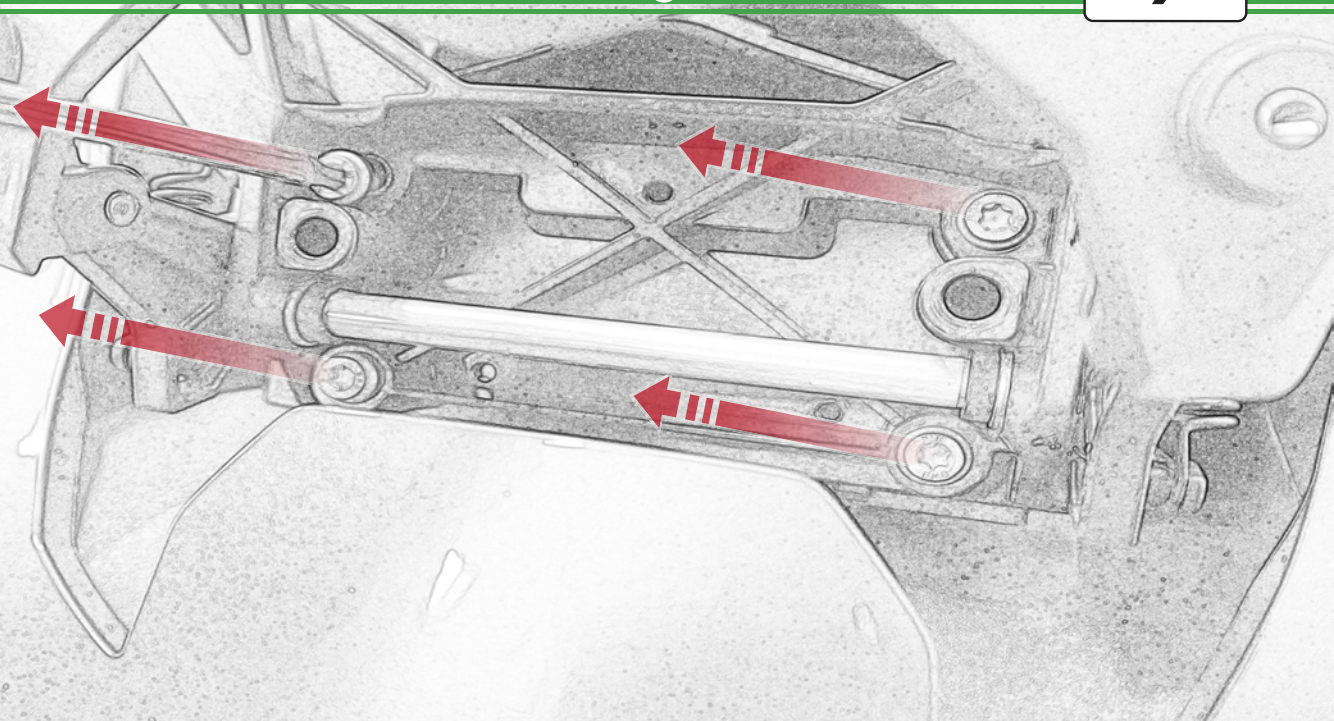

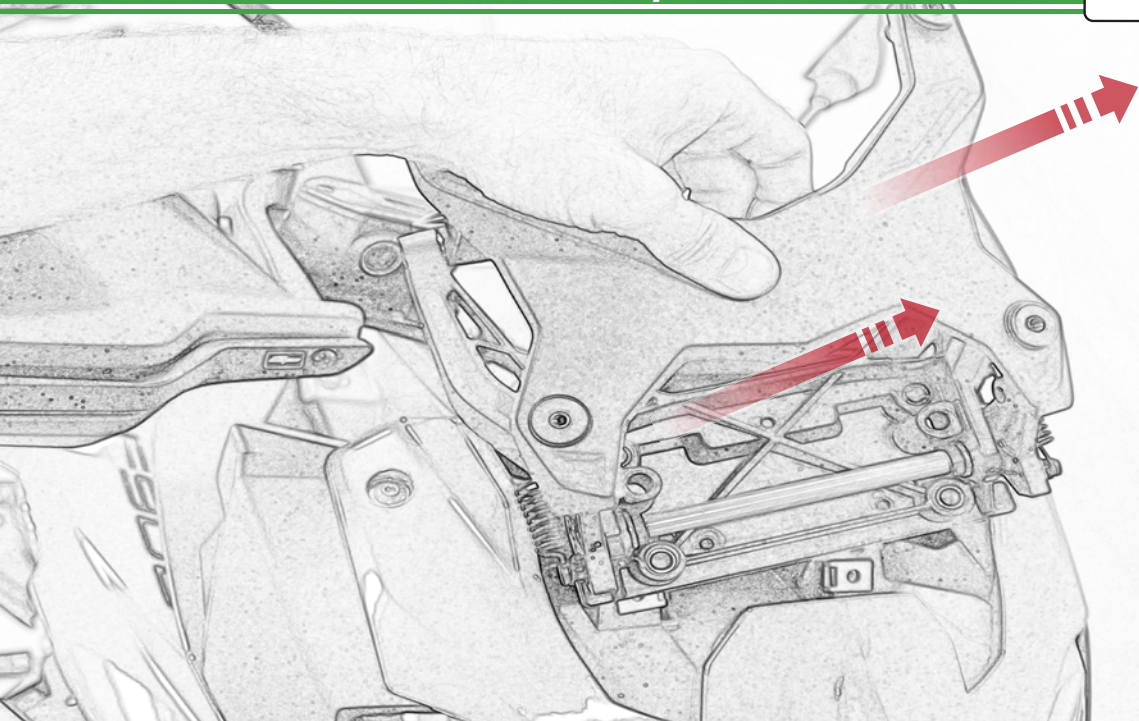

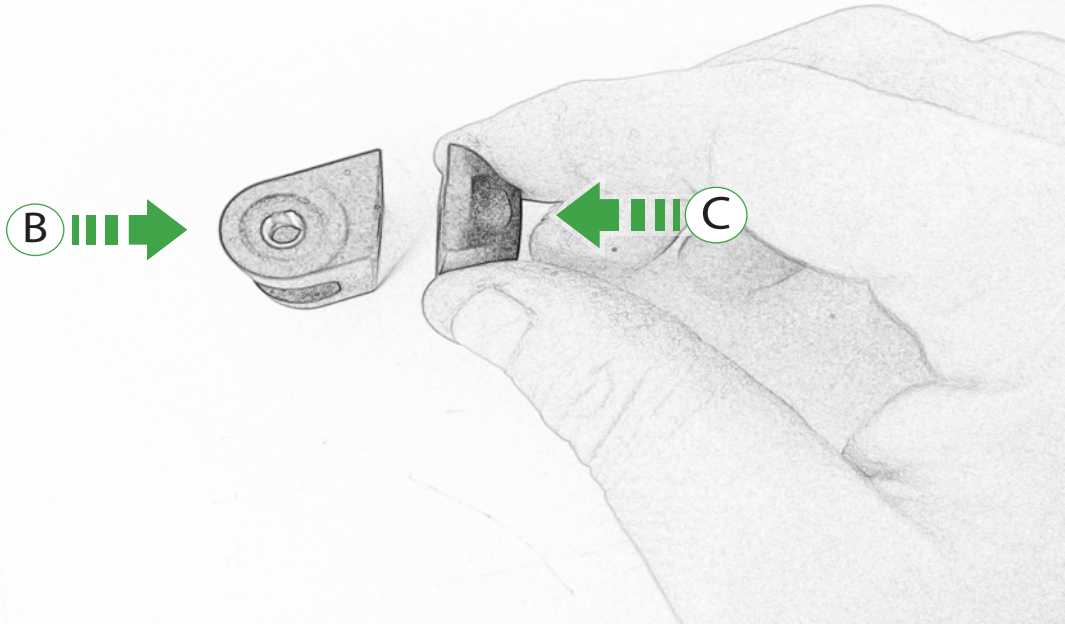

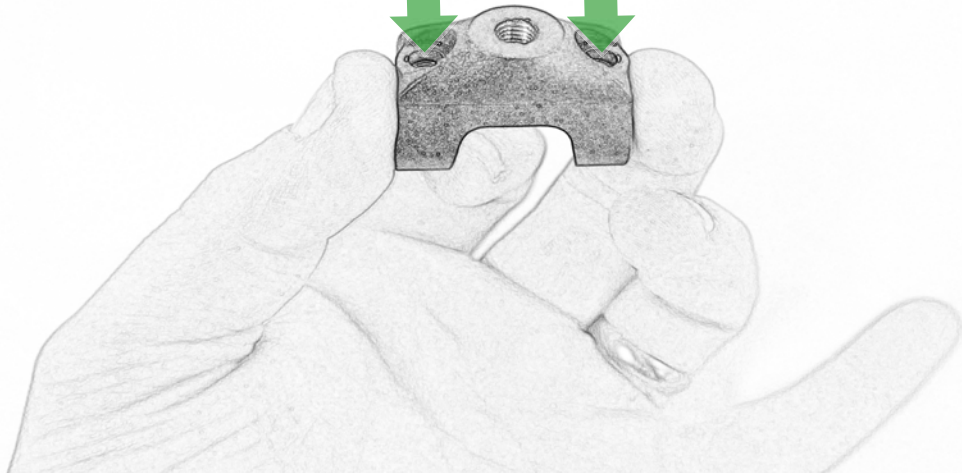
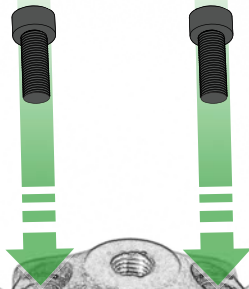

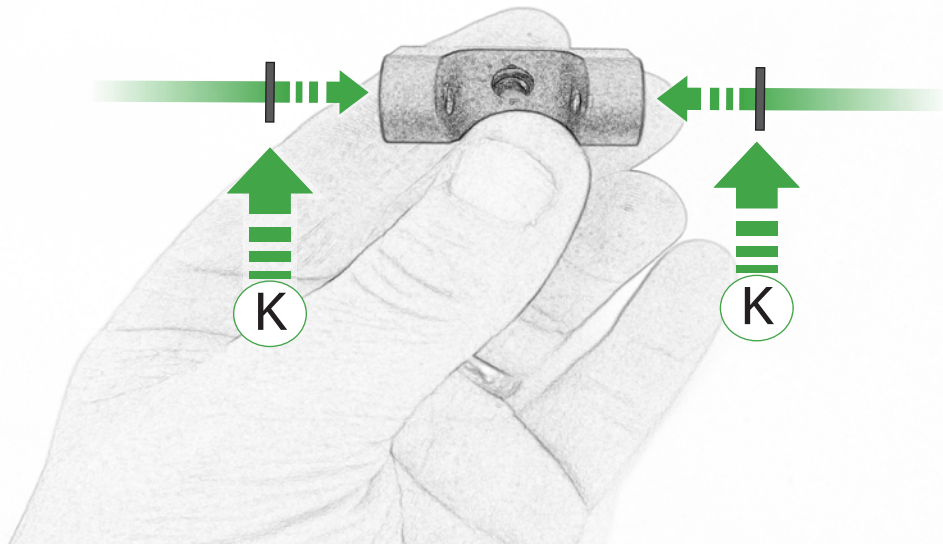

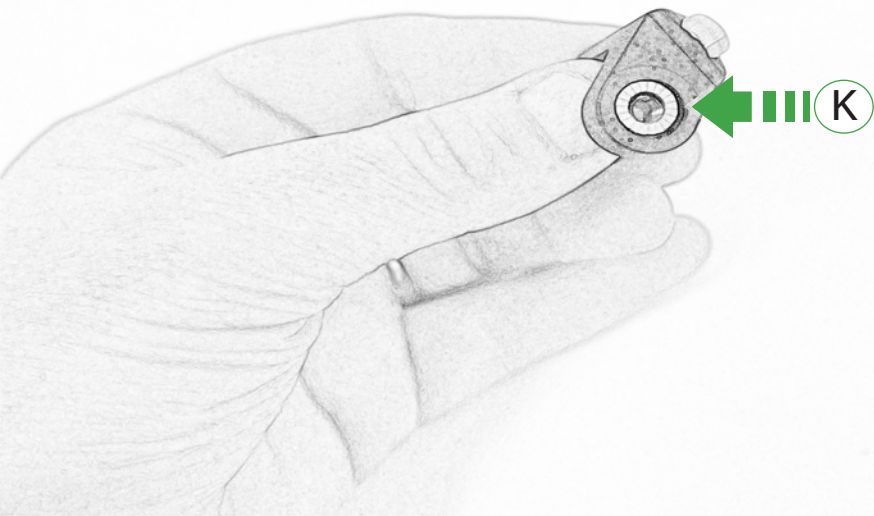

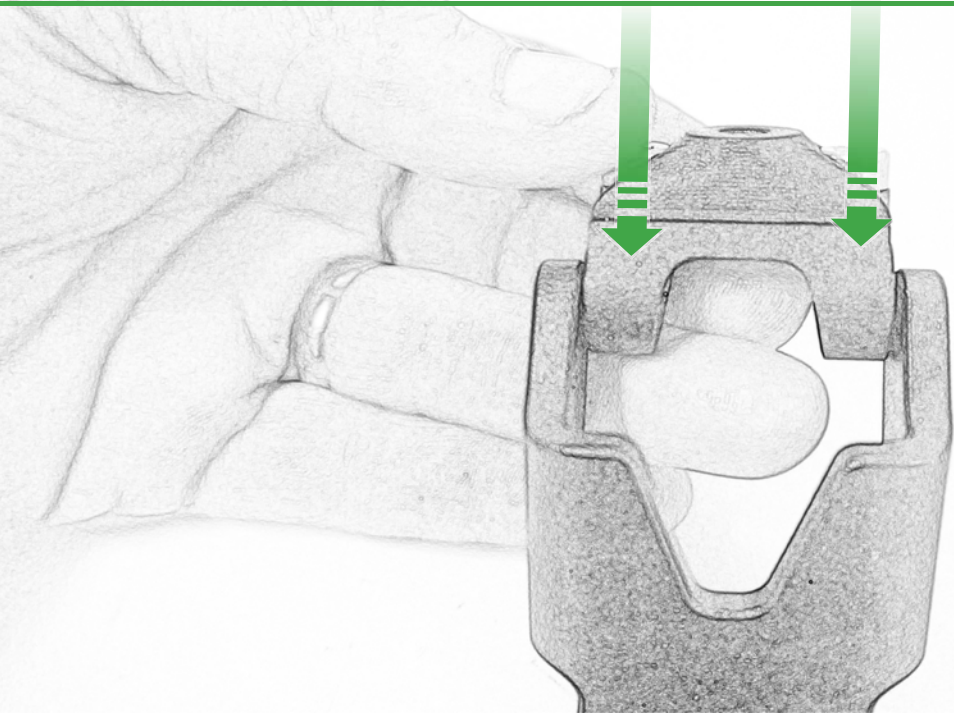

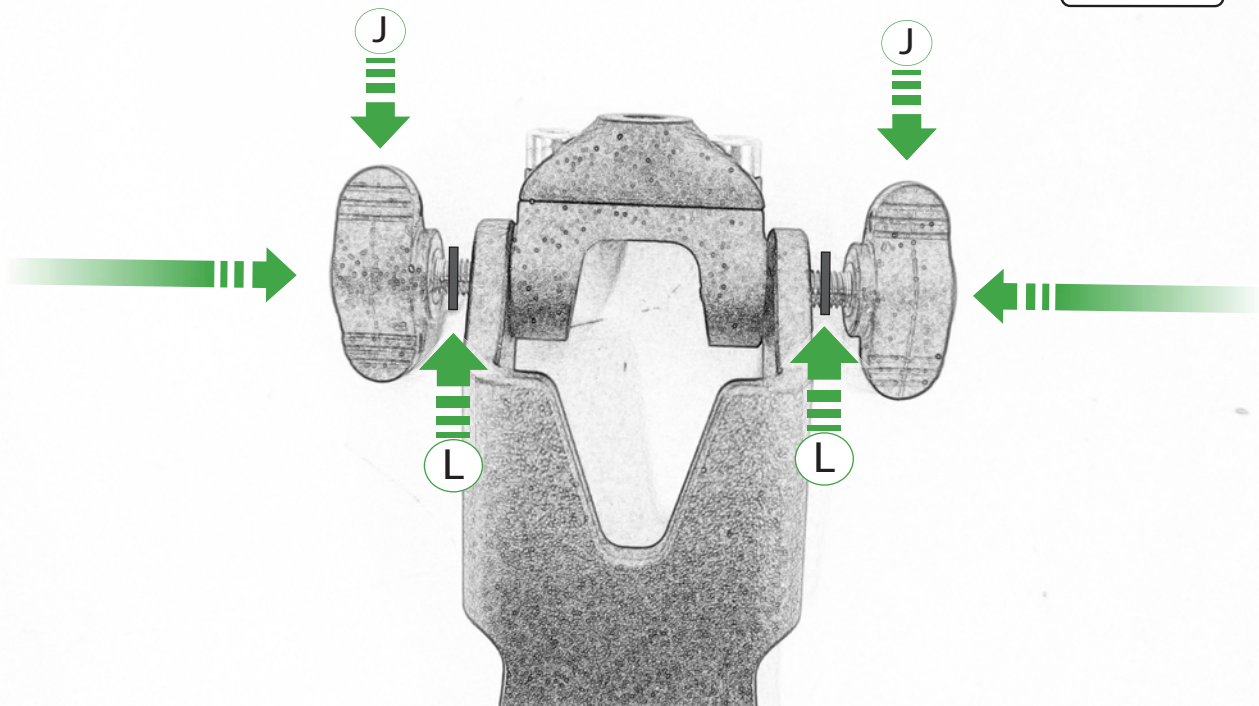



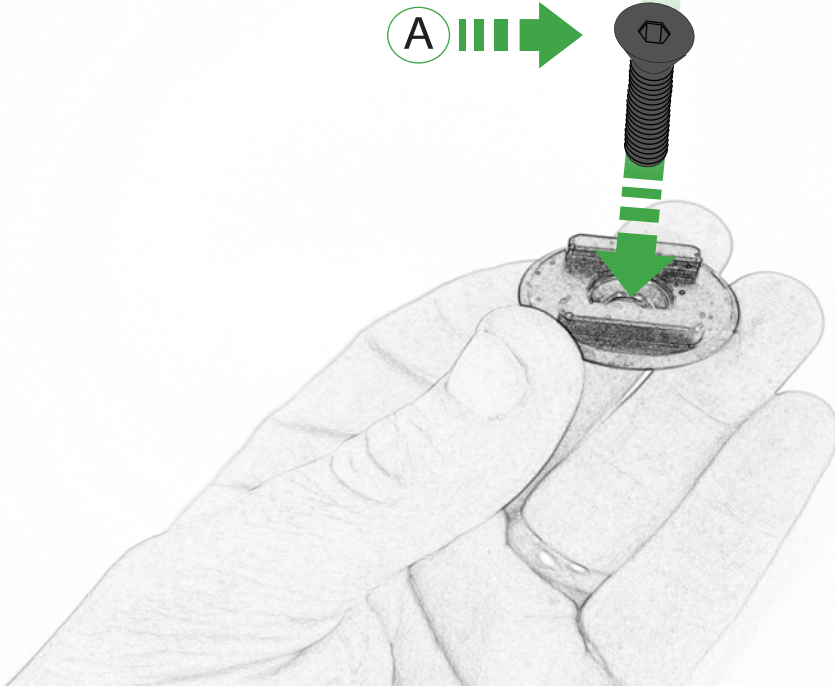

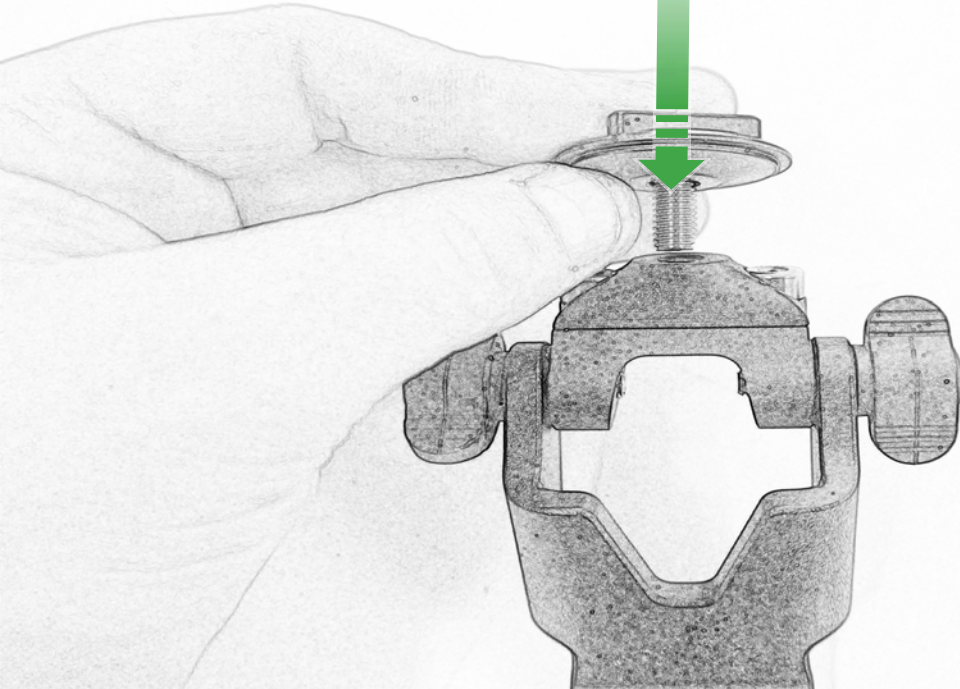

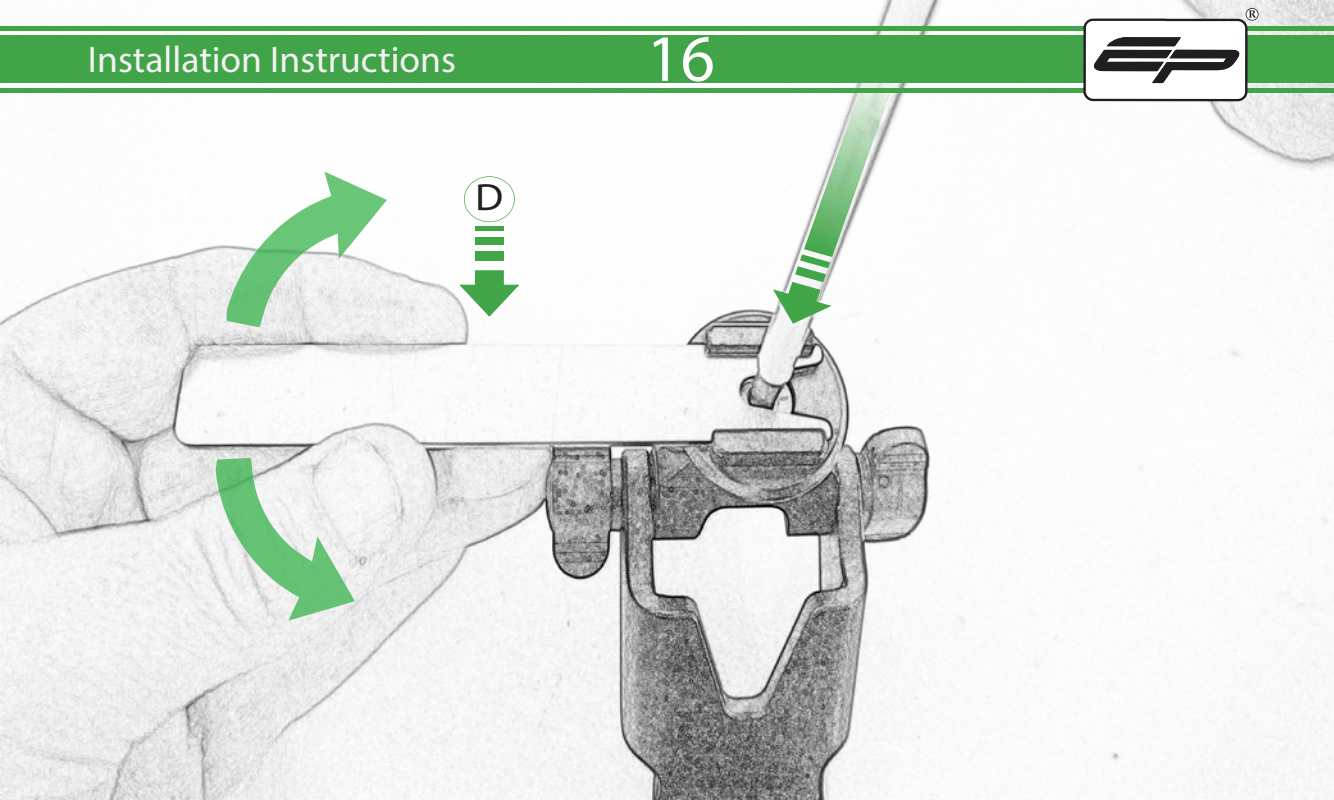

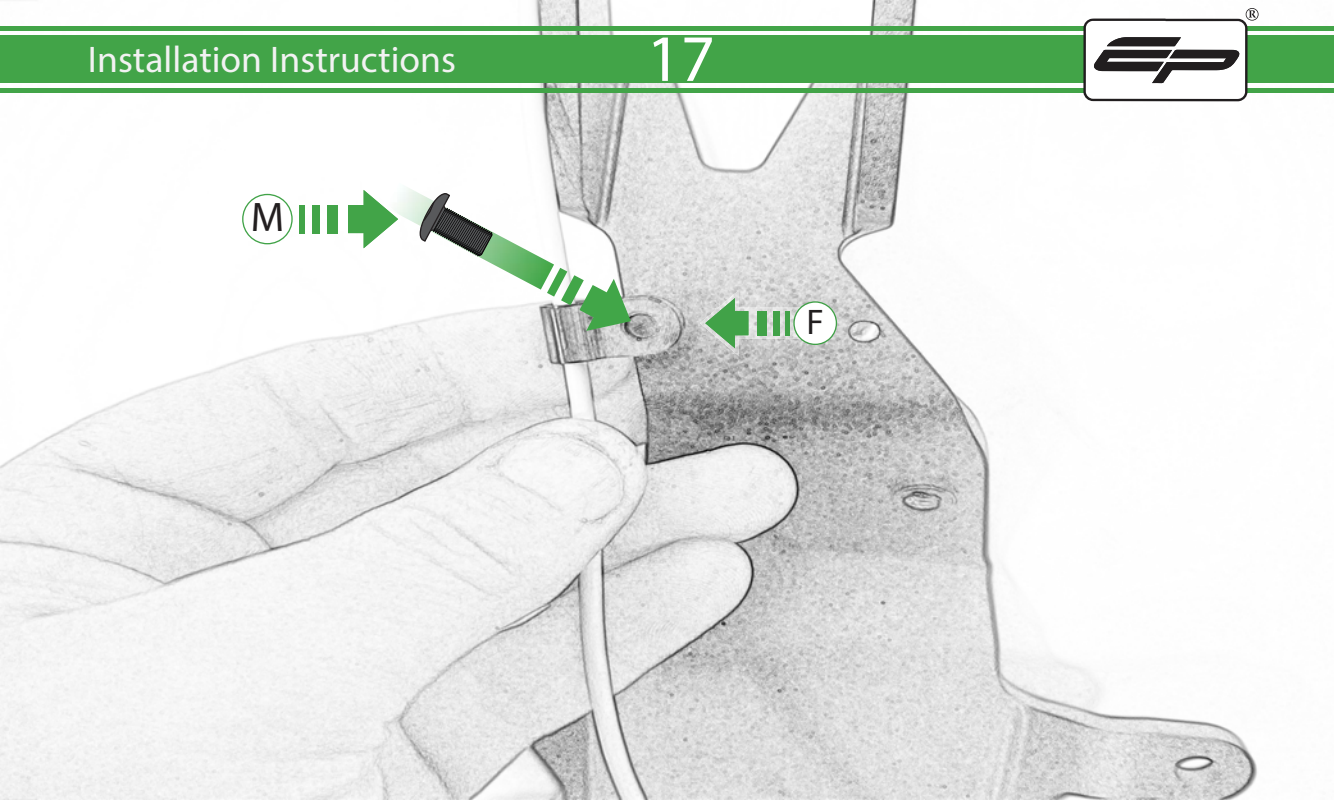

M

F

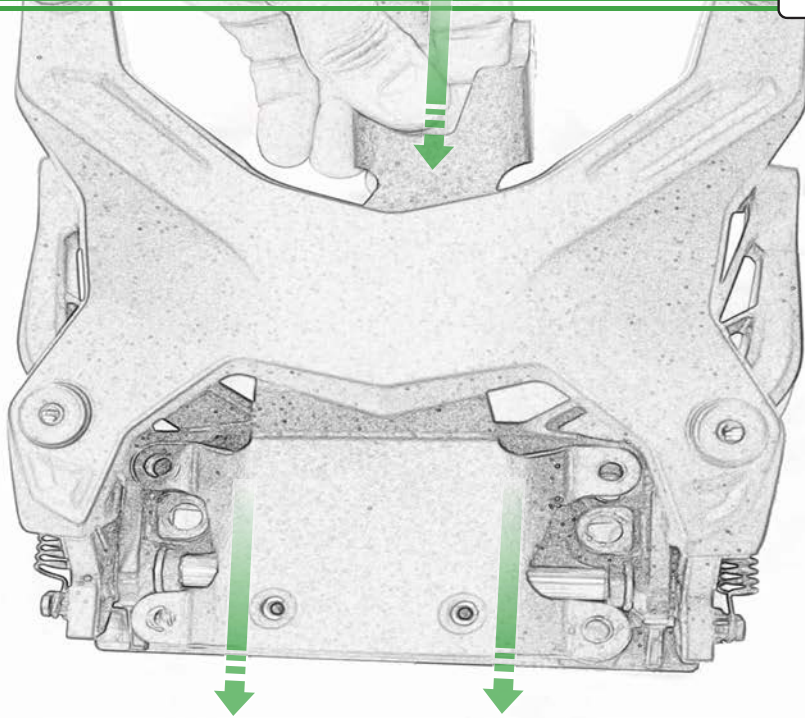

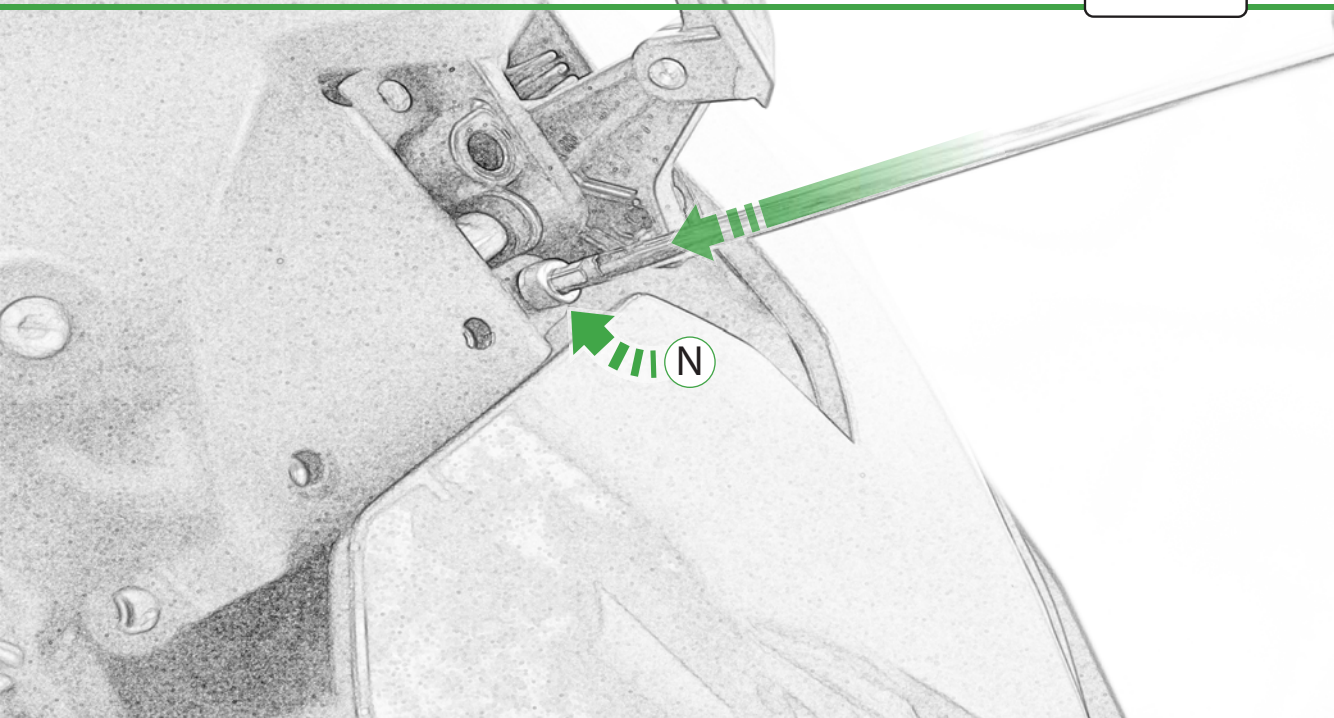

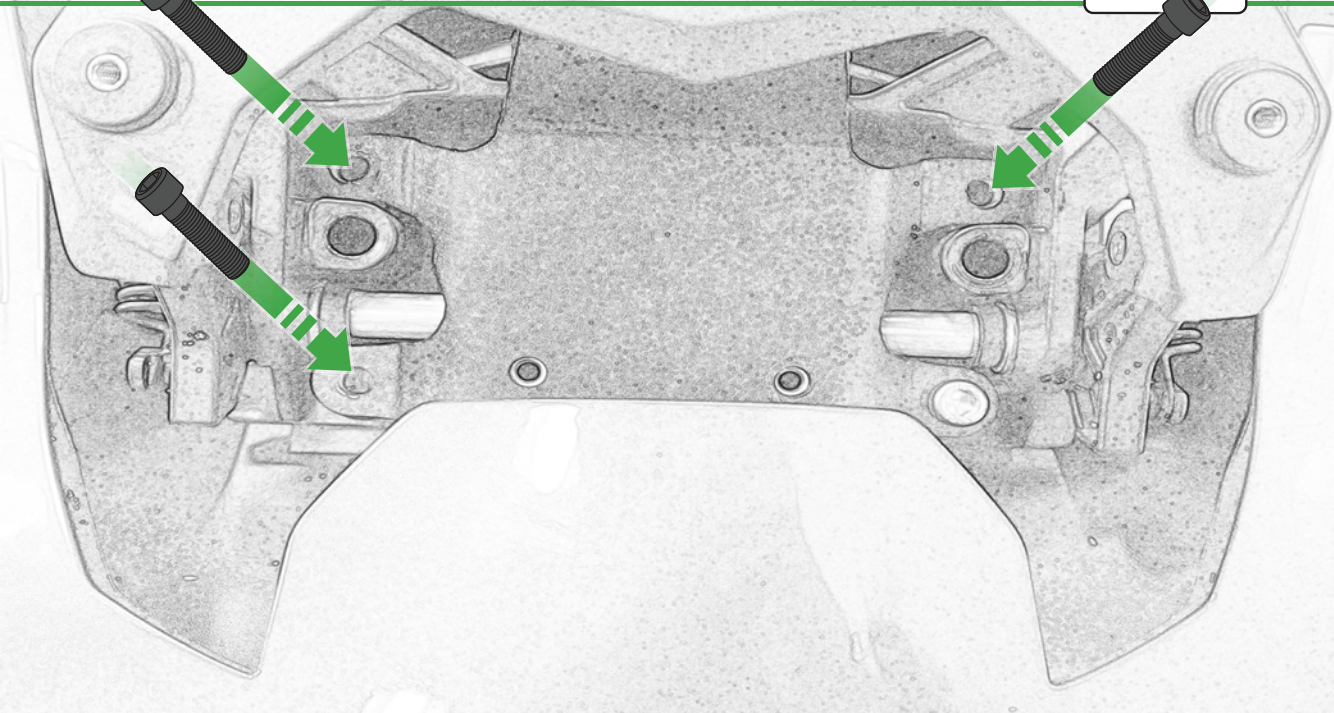

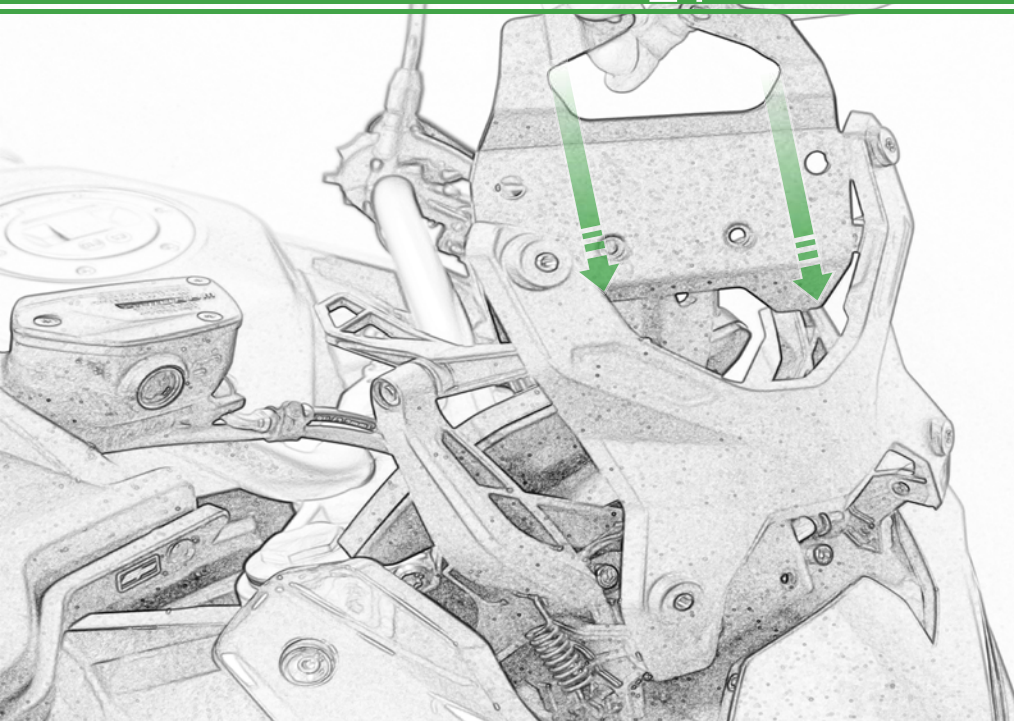



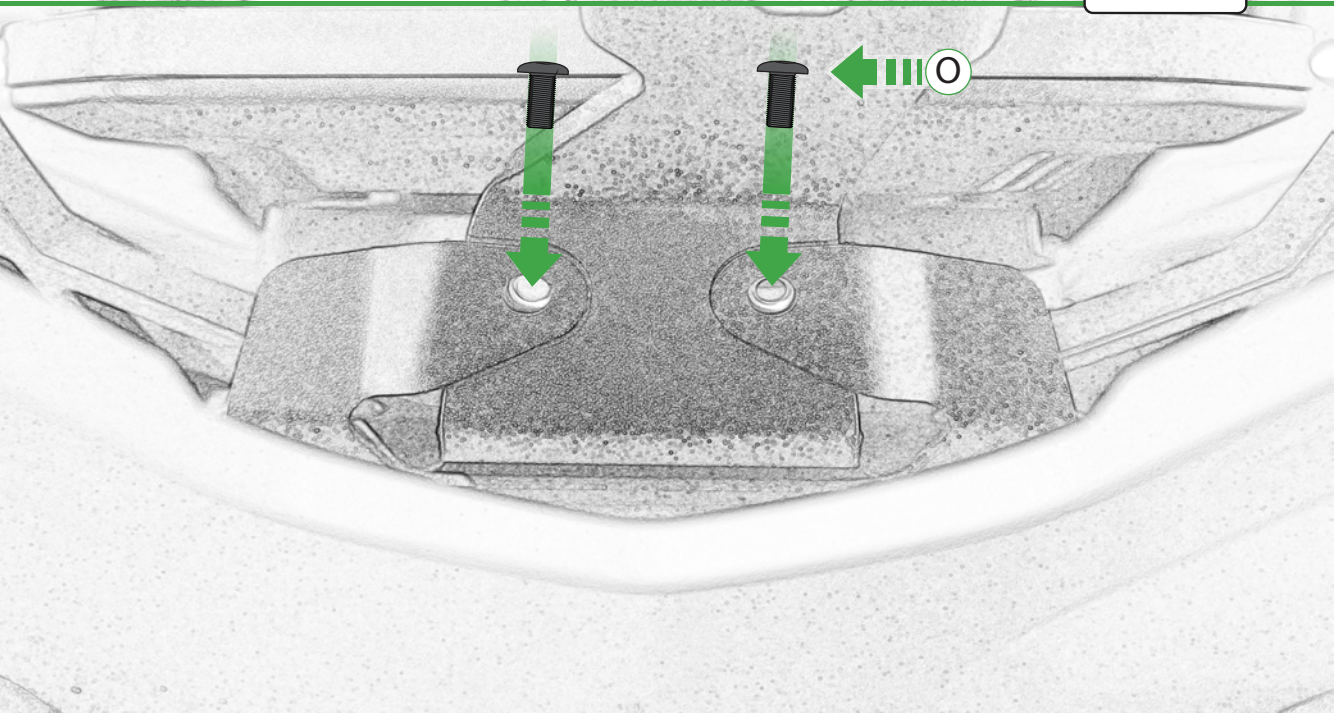



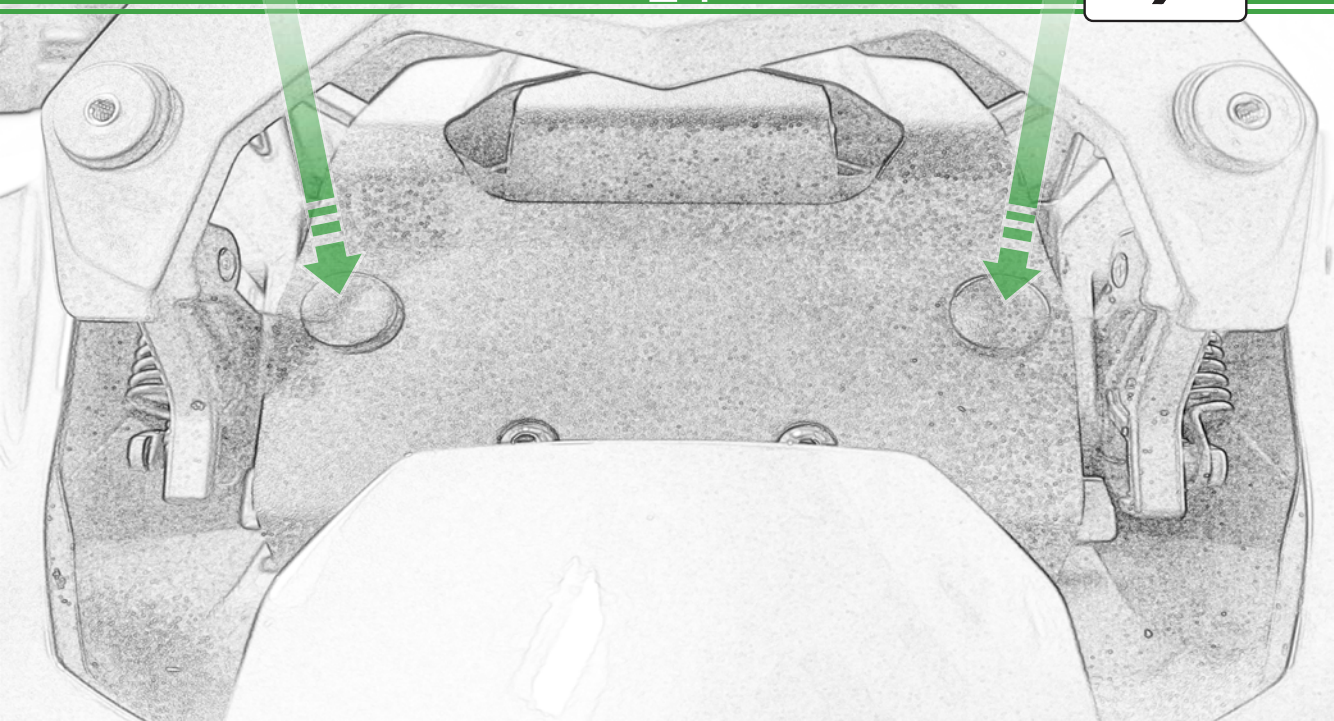

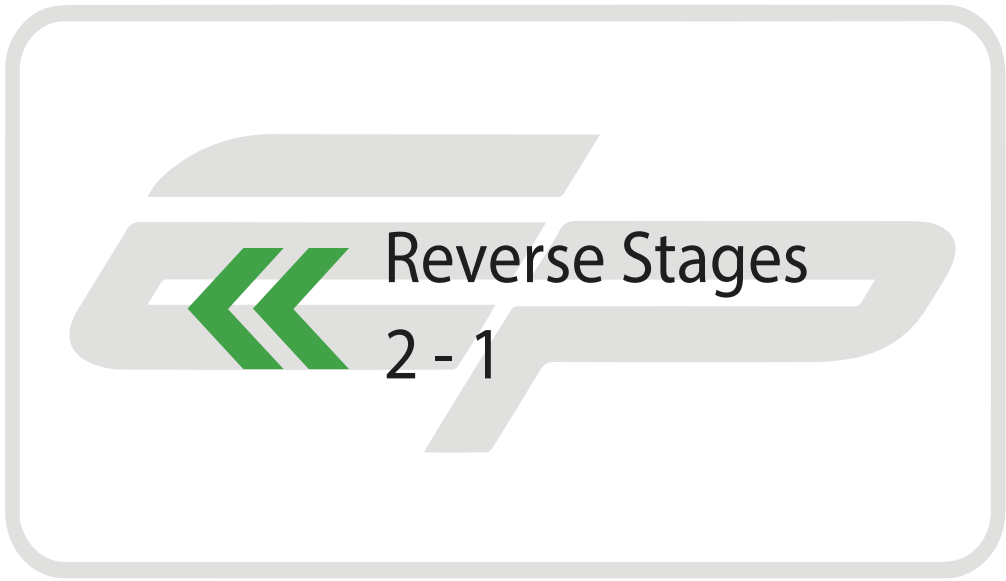

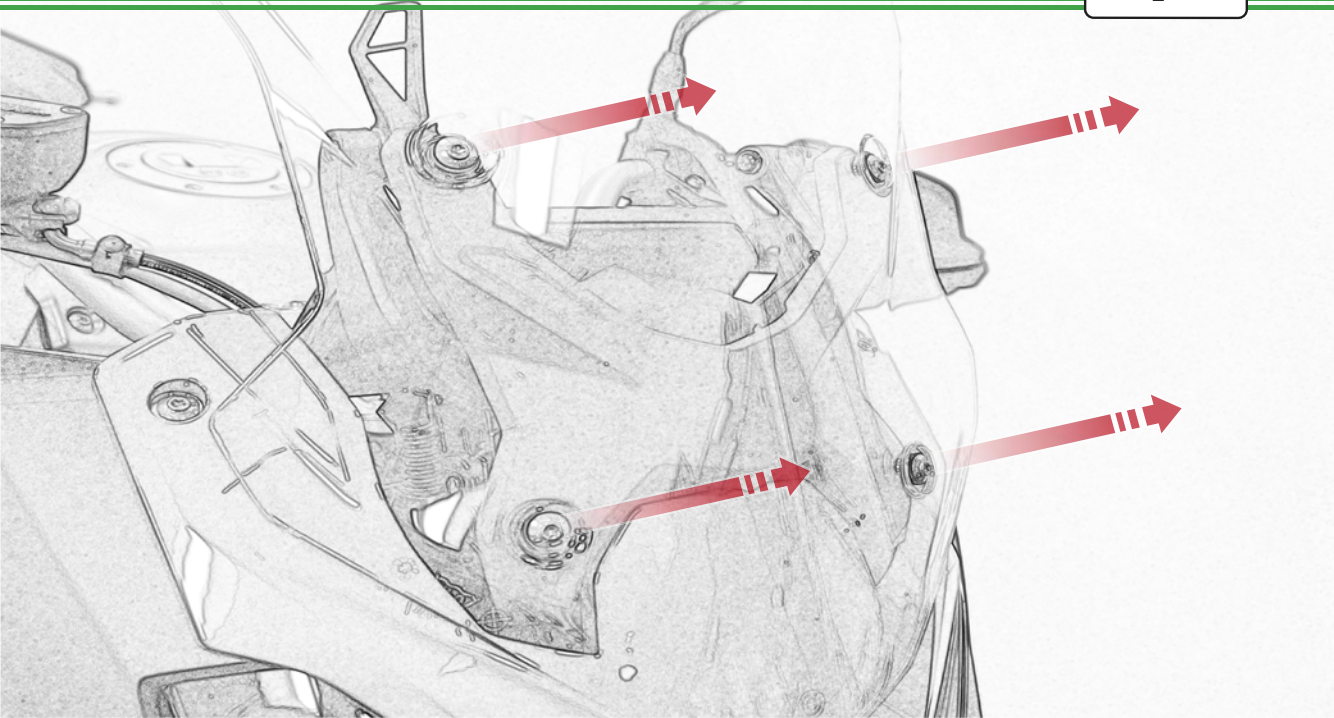

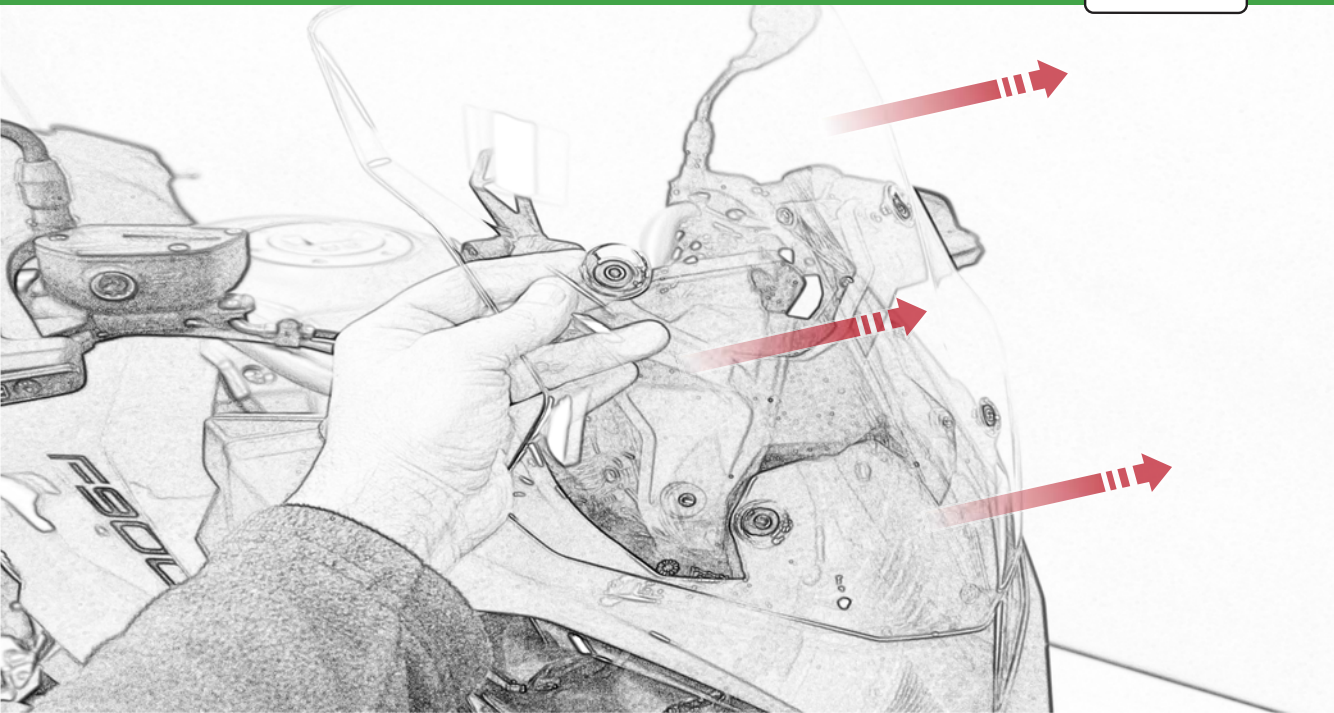



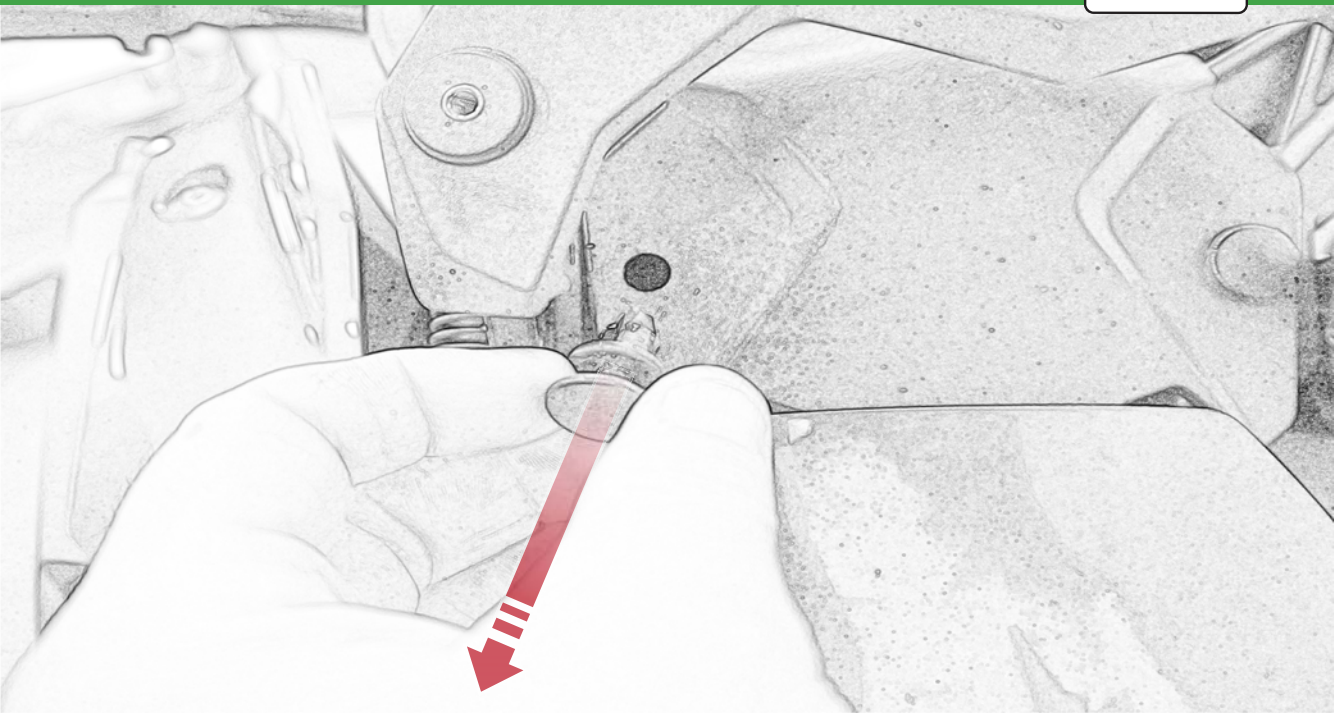



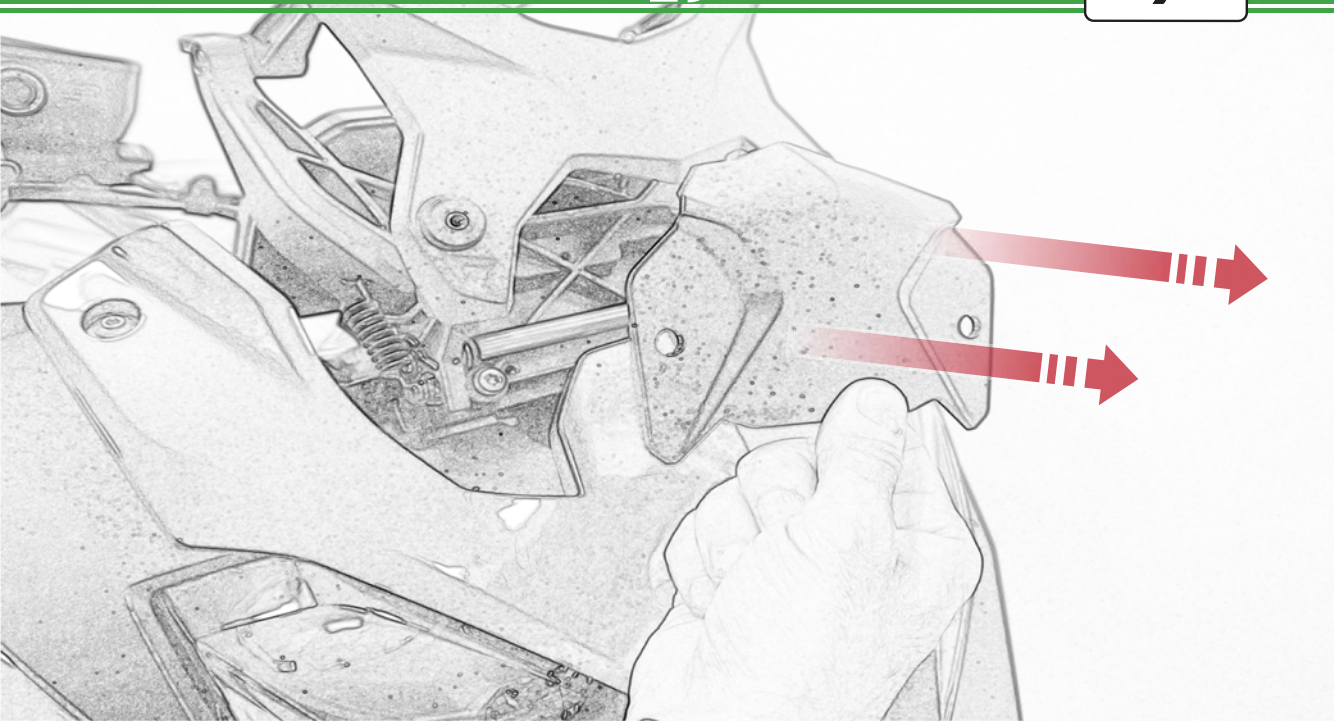

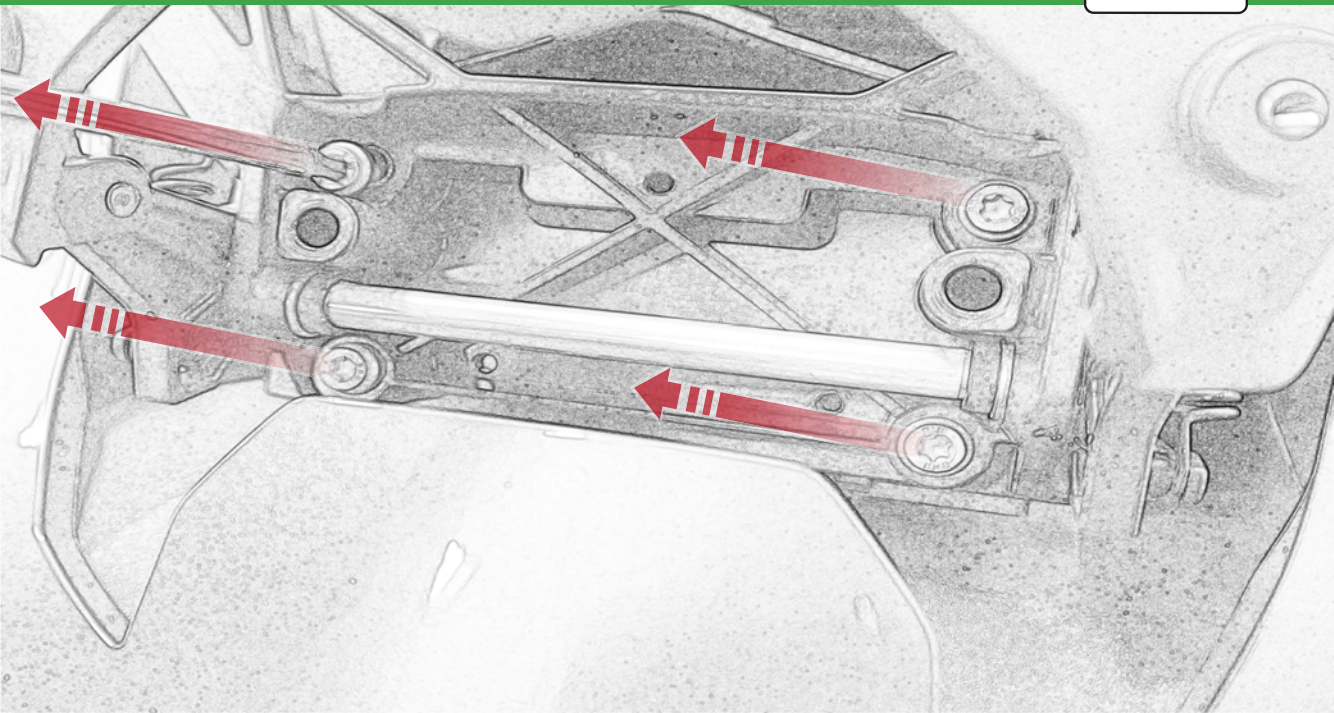

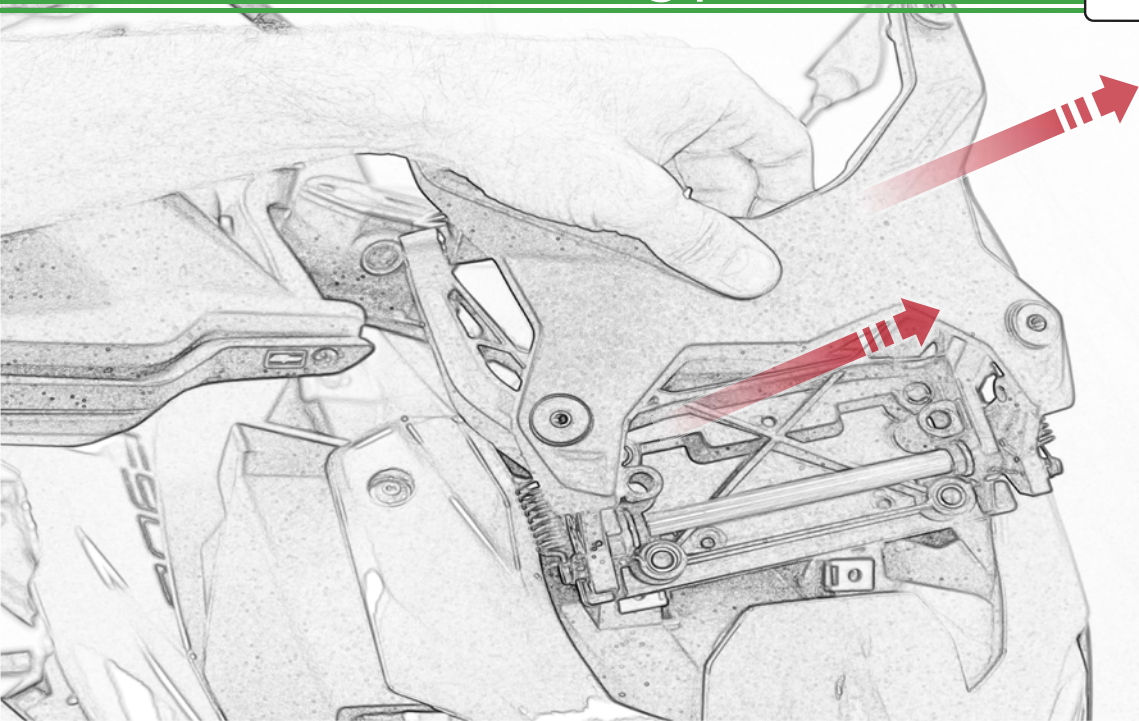

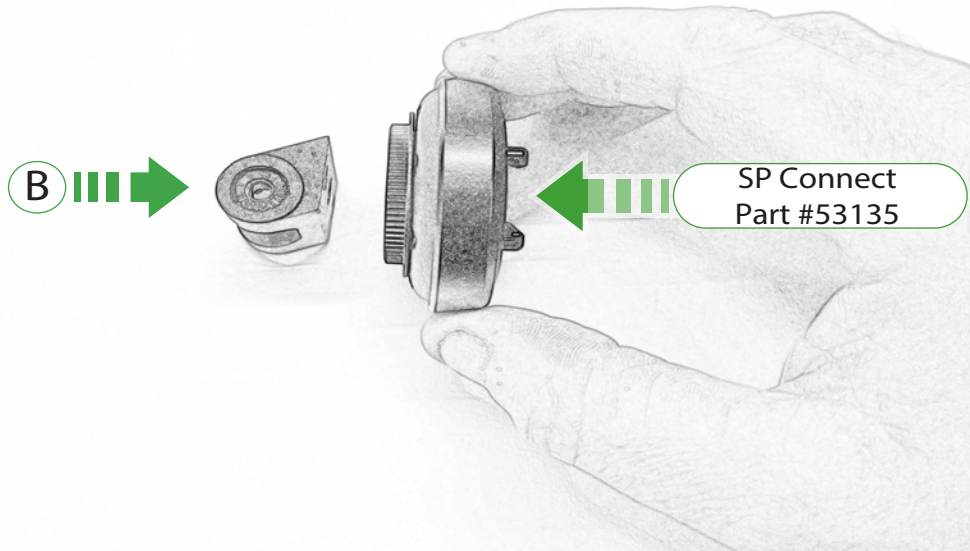

B

SP Connect  
Part #53135

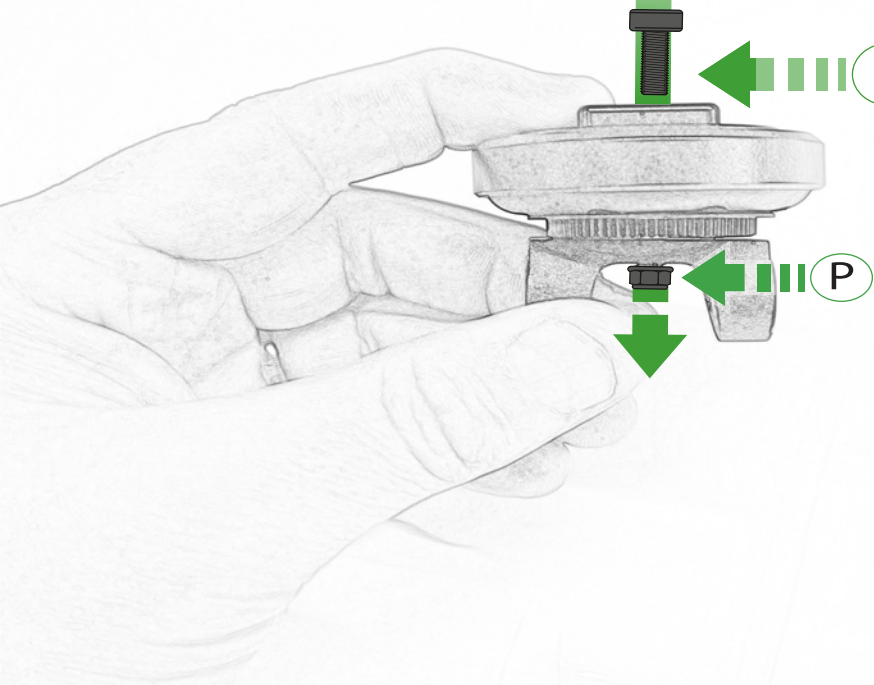

Supplied with  
#53135

P

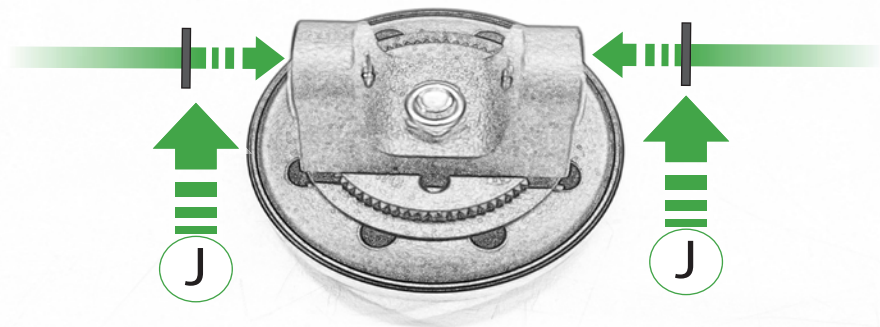

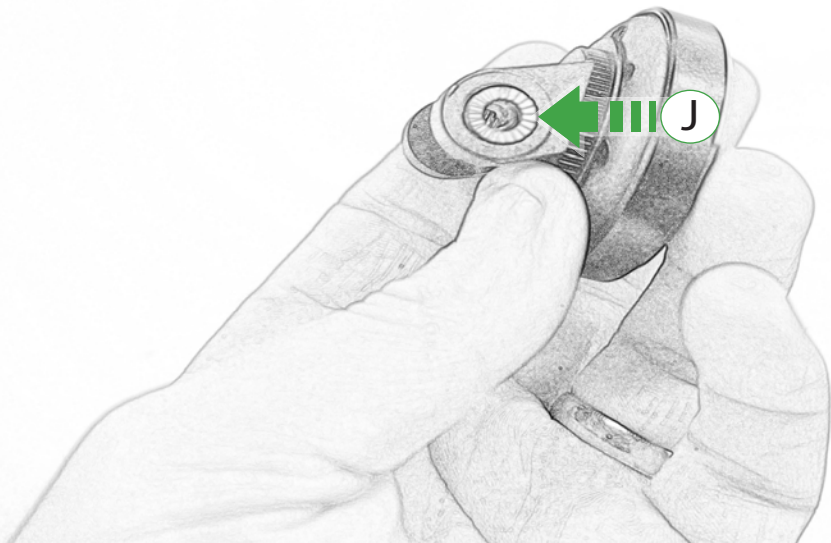

Repeat  
Both Sides

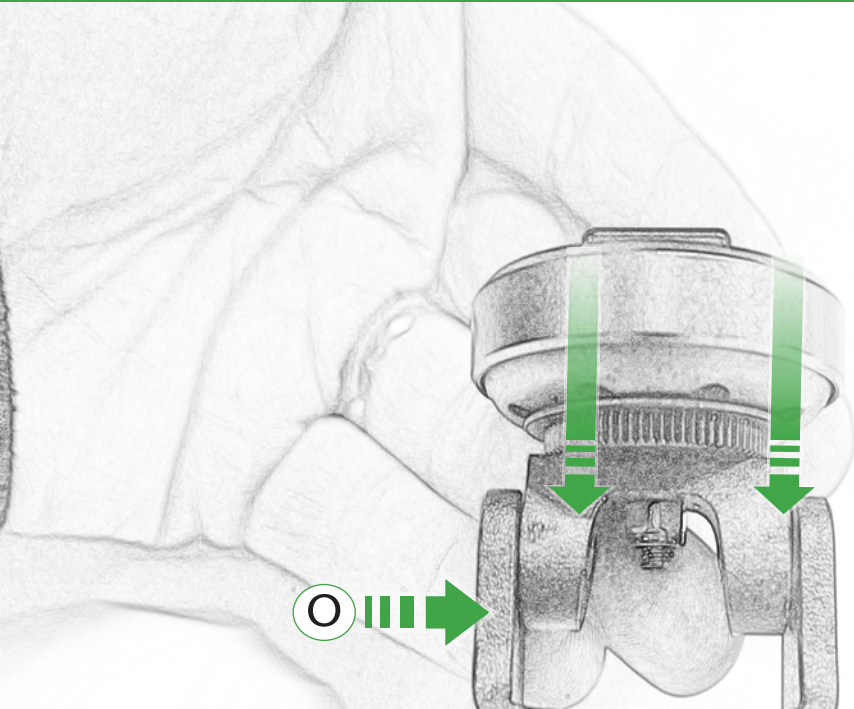



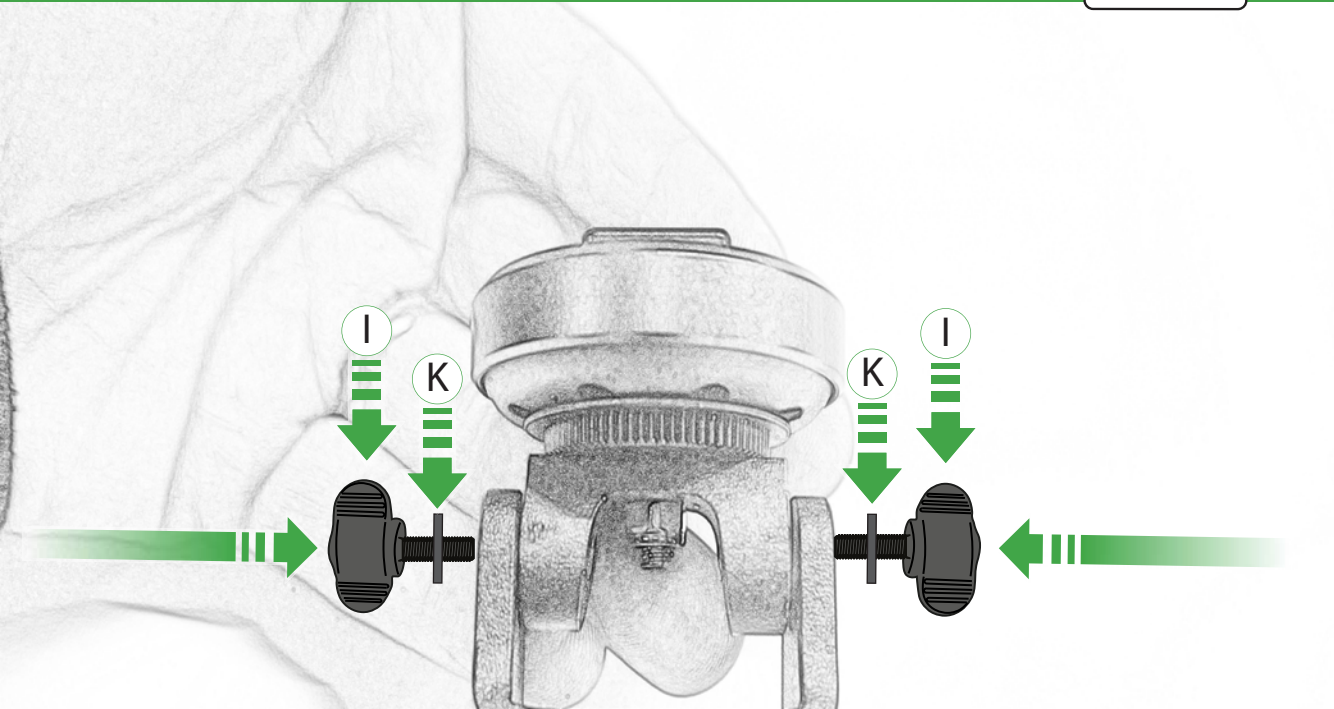

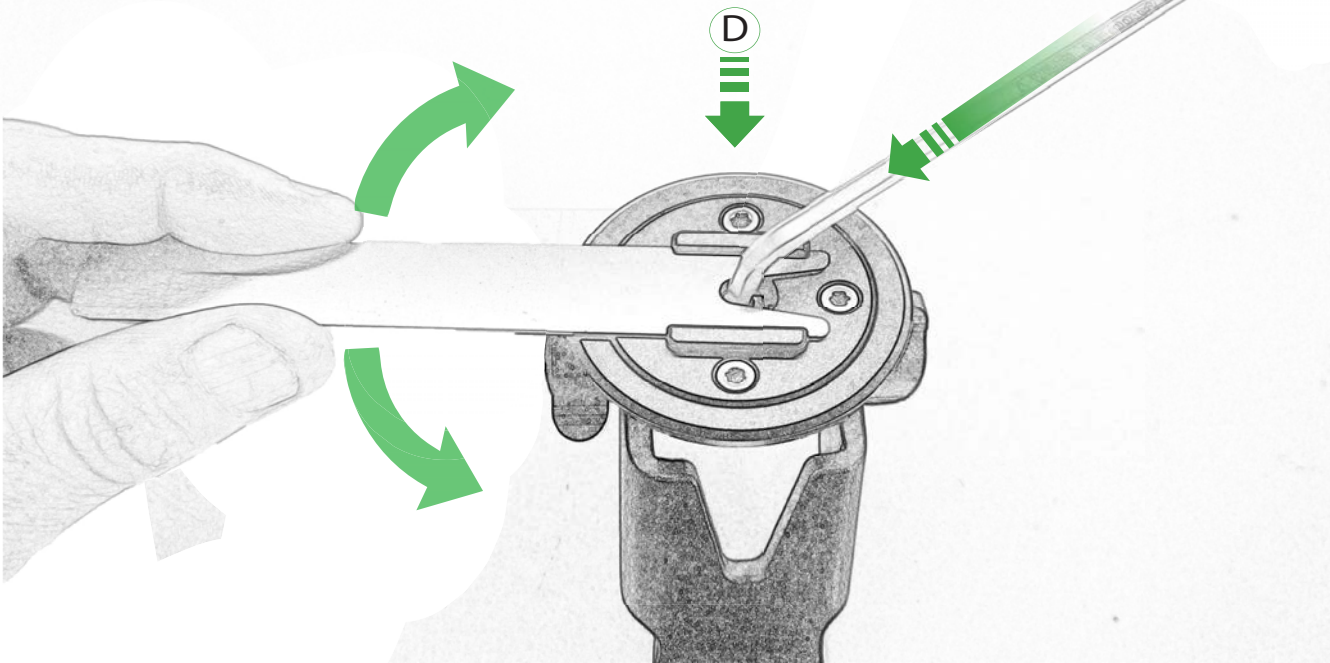

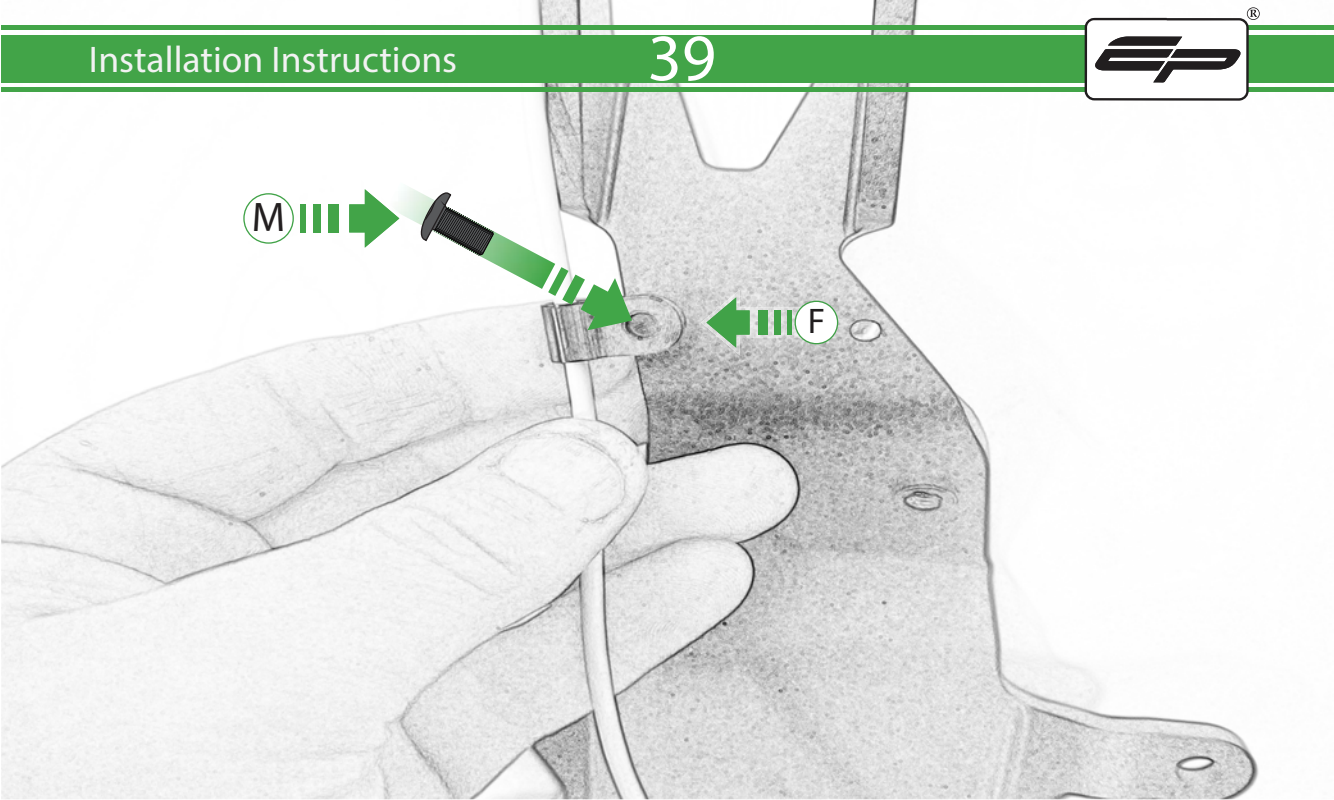

M

F

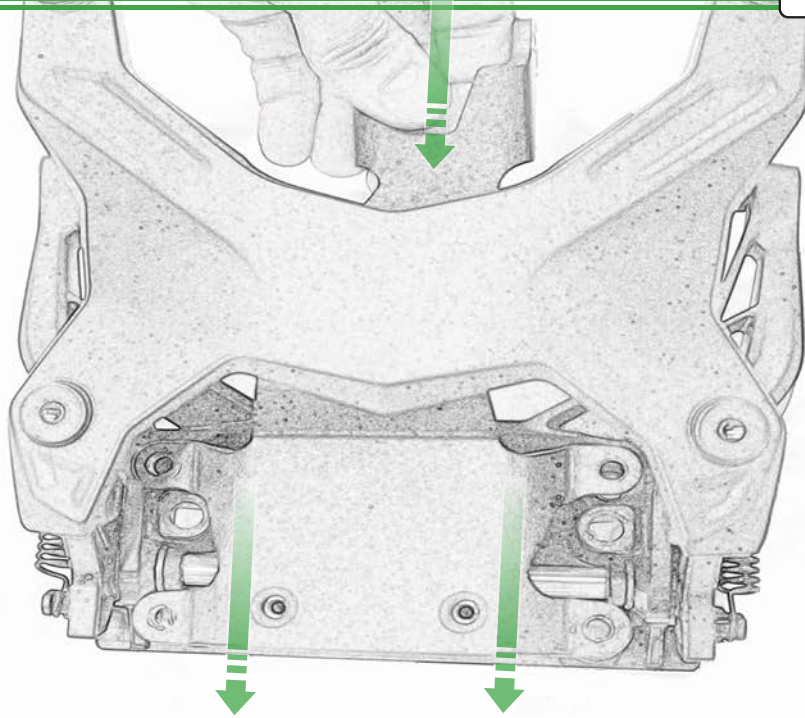

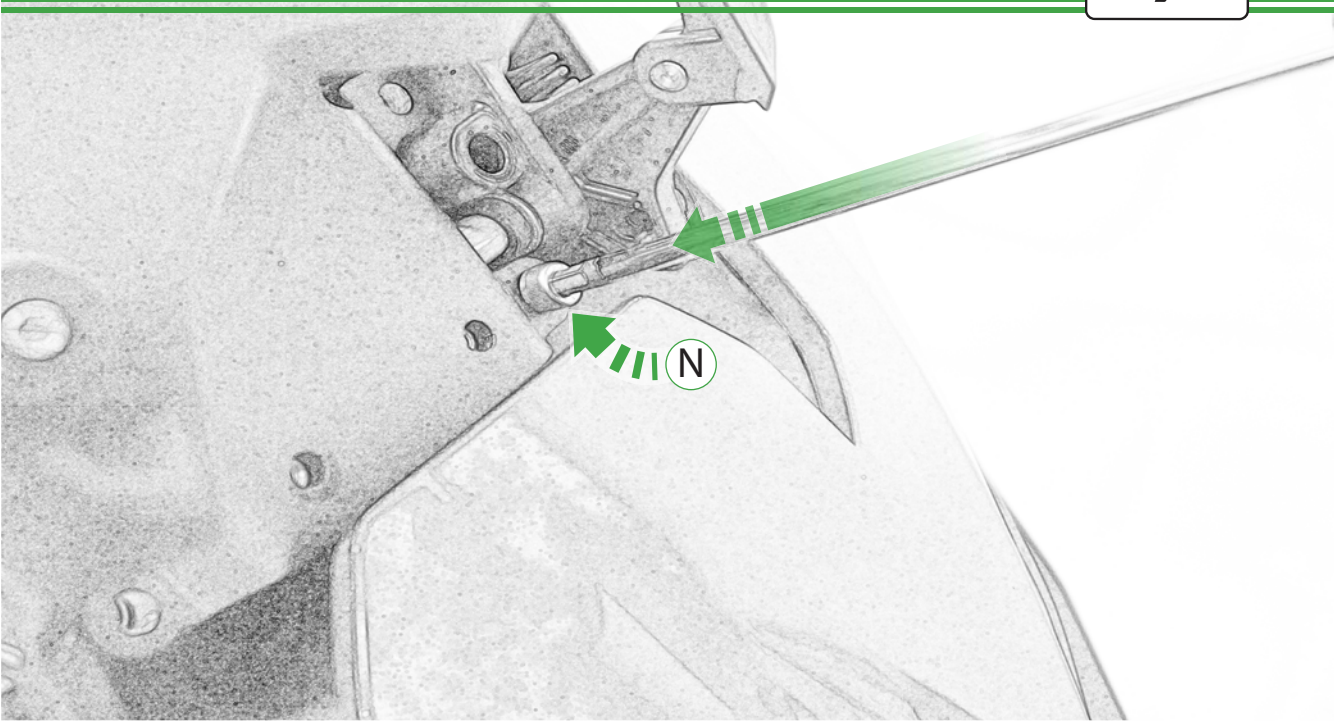

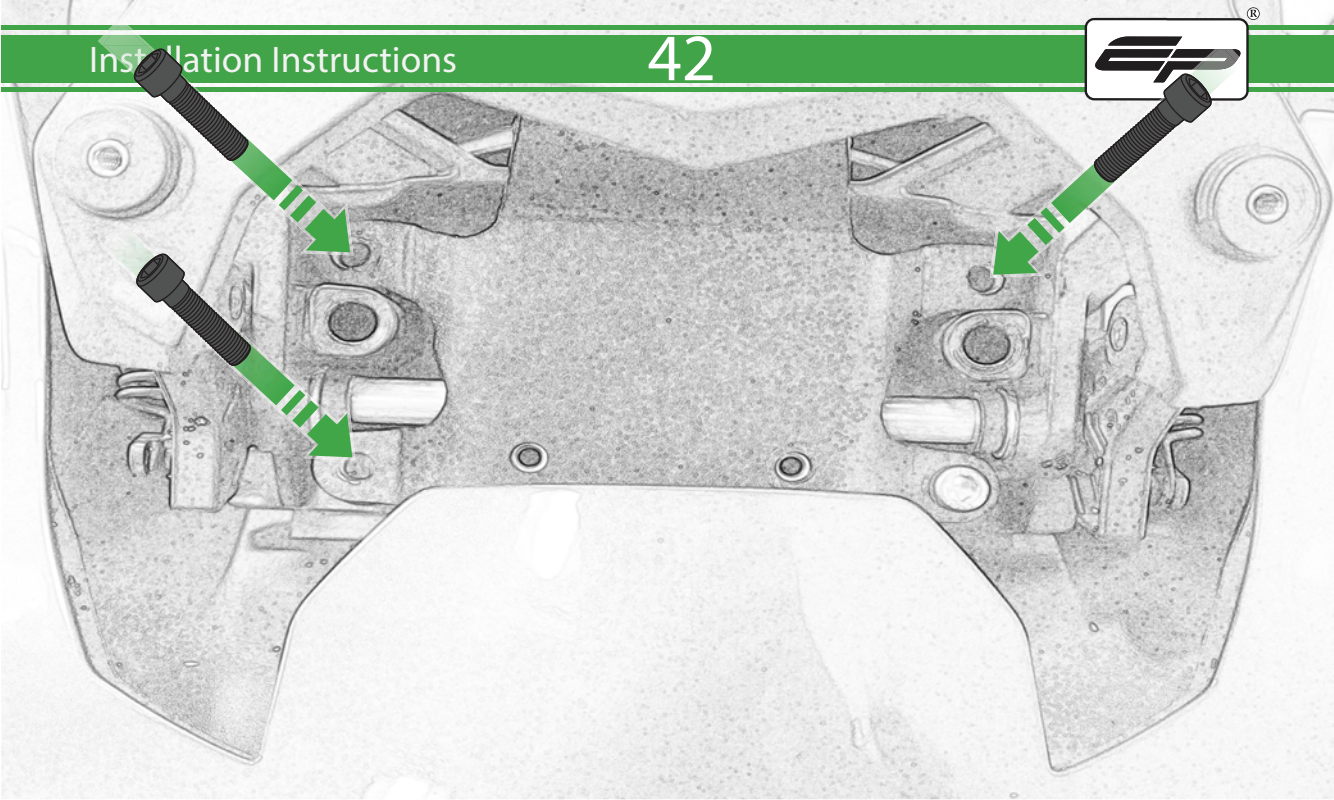

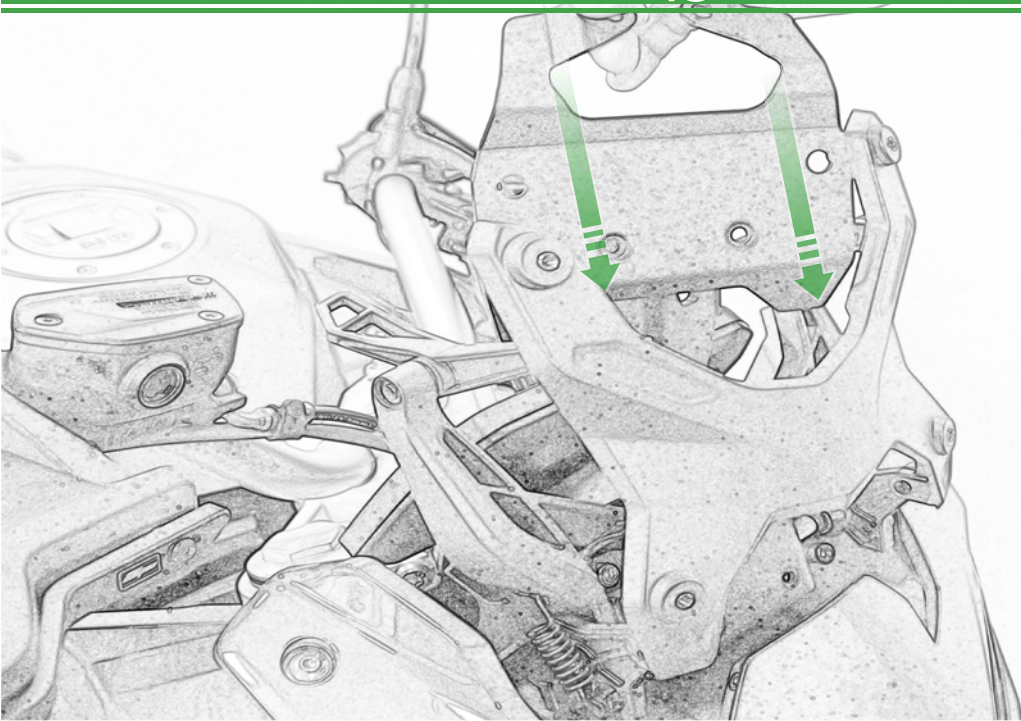





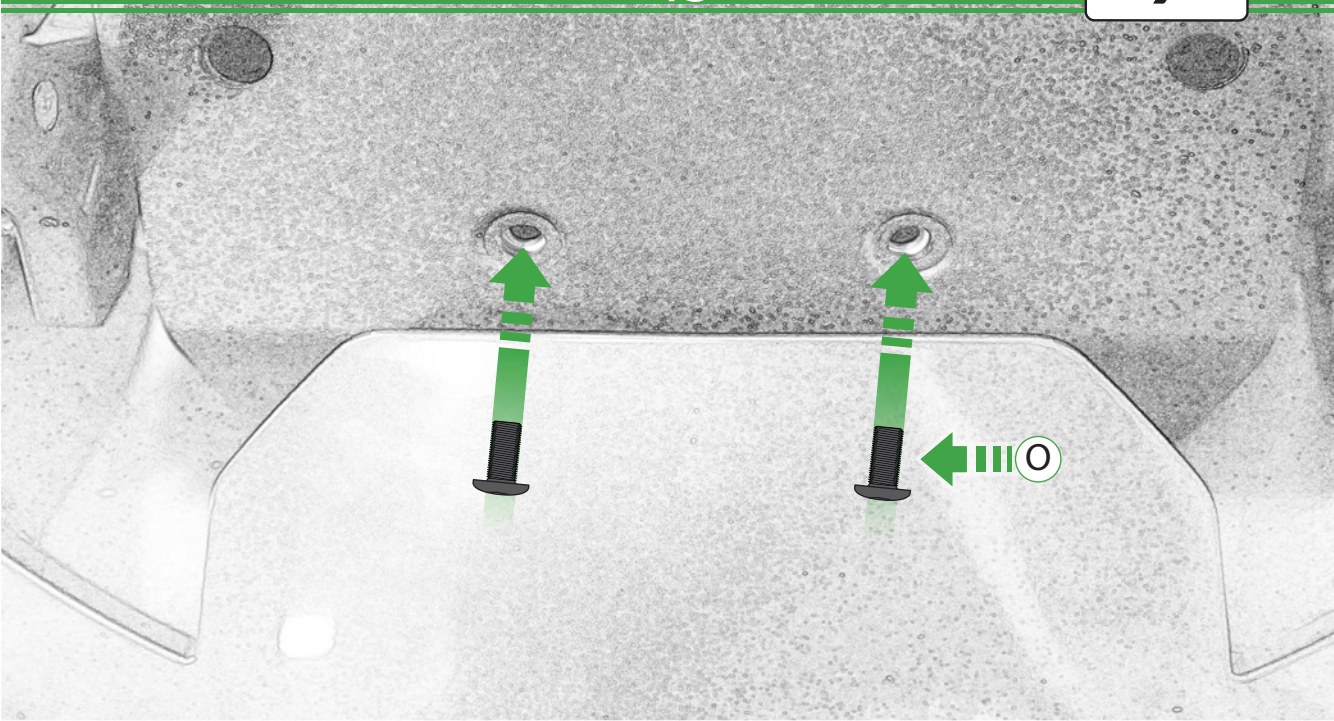

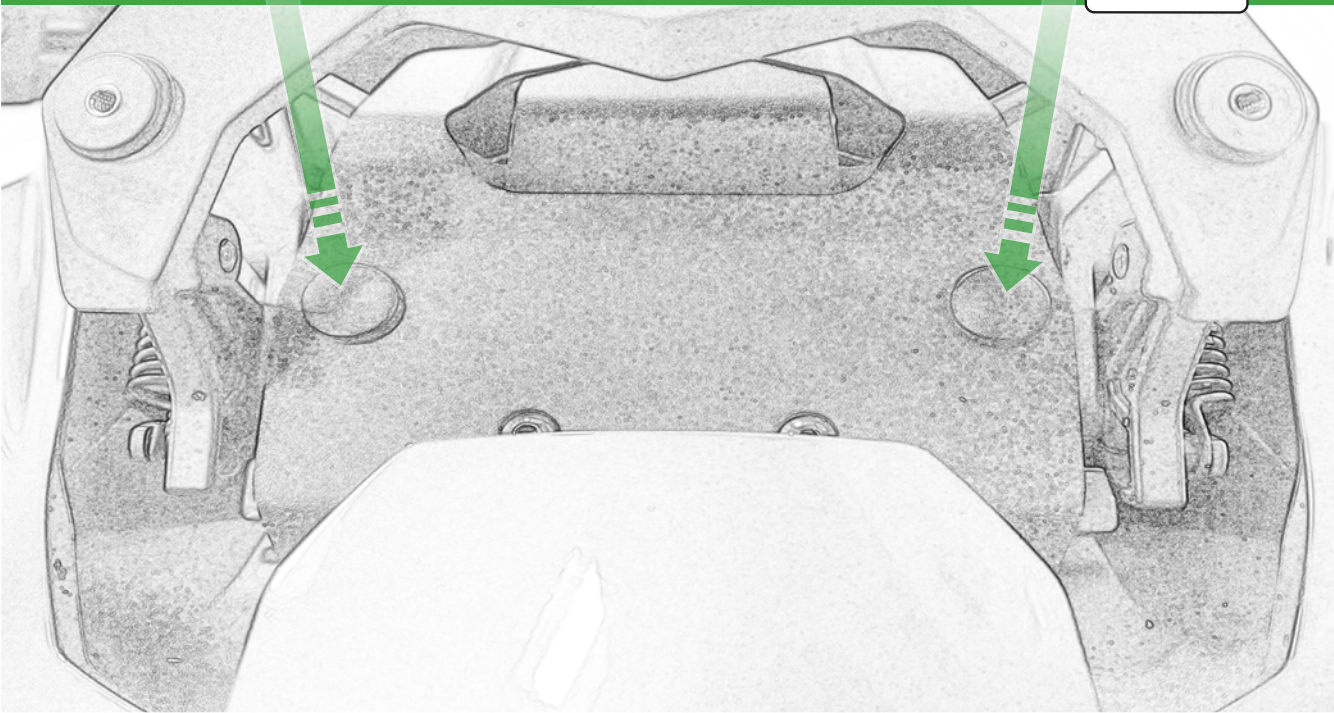

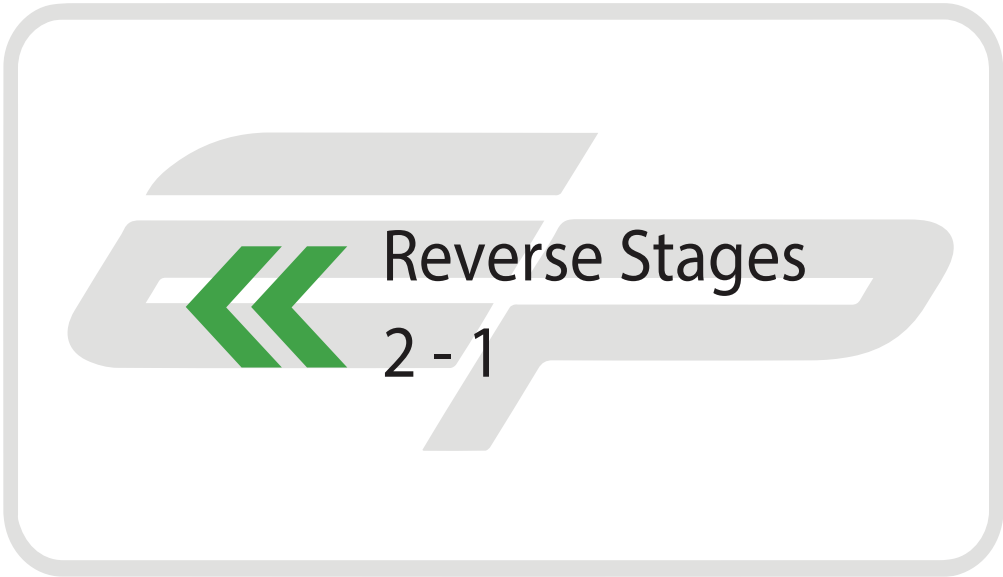



## ESSENTIAL CHECKS

It is recommended that periodic inspections are made to ensure that all bolts are tightened to the specified torque settings.

Should the bike be involved in an accident a thorough inspection should be made and any components that have taken an impact, no matter how small, be replaced



**EVOTECH**®  
P E R F O R M A N C E

[www.evotech-performance.com](http://www.evotech-performance.com)