

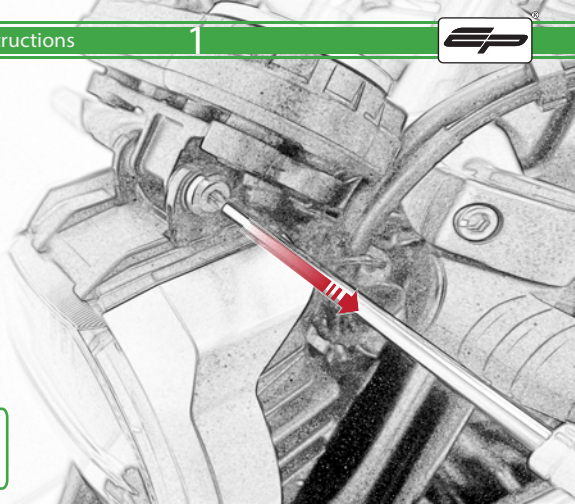

## Kit Contents PRN014567-014655

- (A) 1 x Main Plate
- (B) 1 x Pivot Plate
- (C) 1 x Sub Mounting Bracket
- (D) 2 x P-clips (No.1)
- (E) 2 x P-clips (No.2)
- (F) 2 x P-clips (No.3)
- (G) 2 x P-clips (No.4)
- (H) 2 x M5 Black Washer
- (I) 2 x M5 x 8mm Black Button head Bolts
- (J) 2 x M4 x 5mm Black Button Head Bolts
- (K) 2 x Lobe Screw
- (L) 2 x Locking Washer
- (M) 4 x 5 x 25mm Forming Screw
- (N) 4 x M5 x 12mm Black Button head Bolts



Repeat  
Both Sides

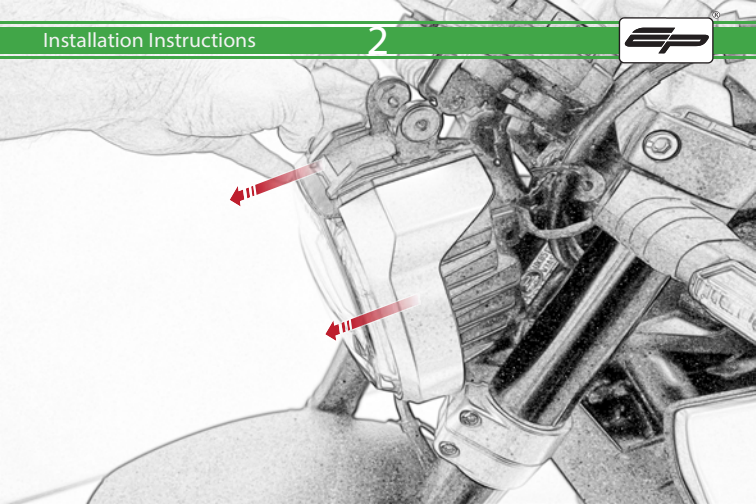

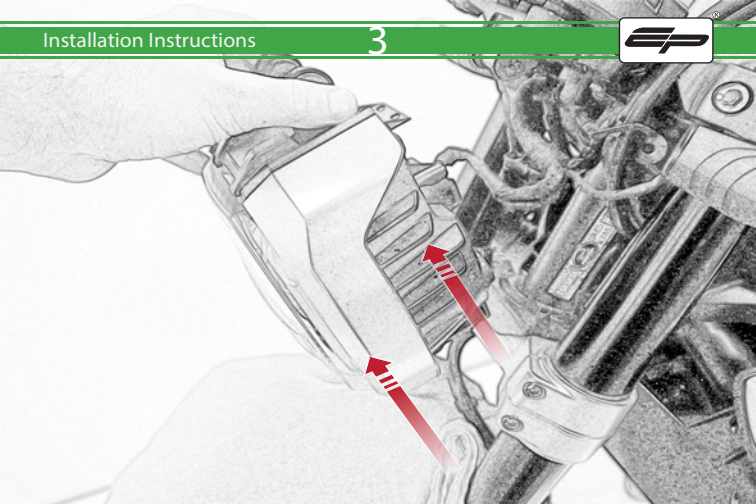

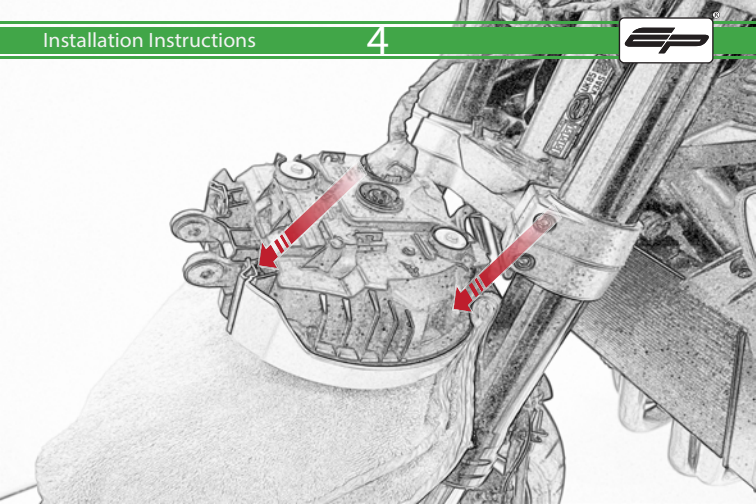

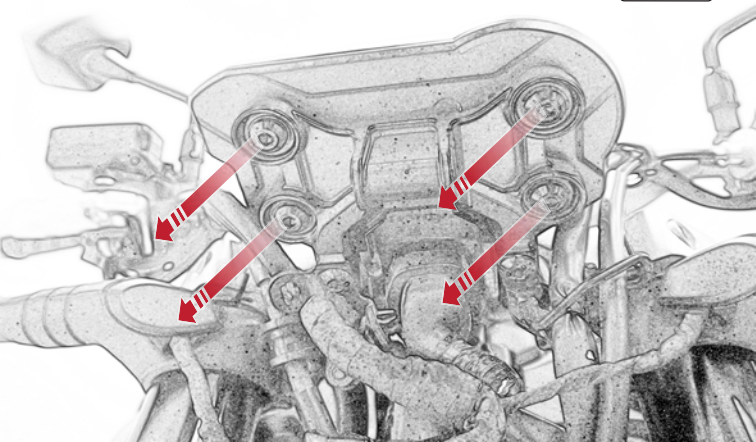



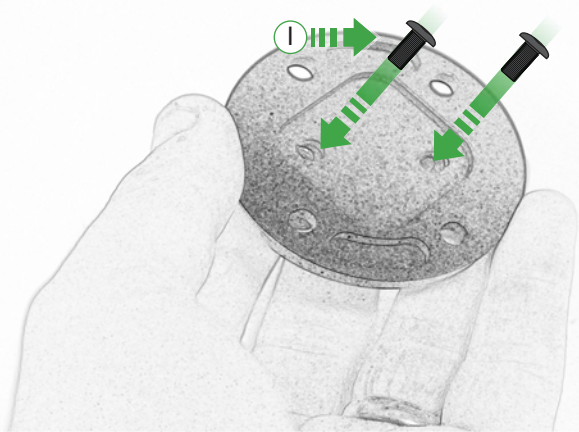



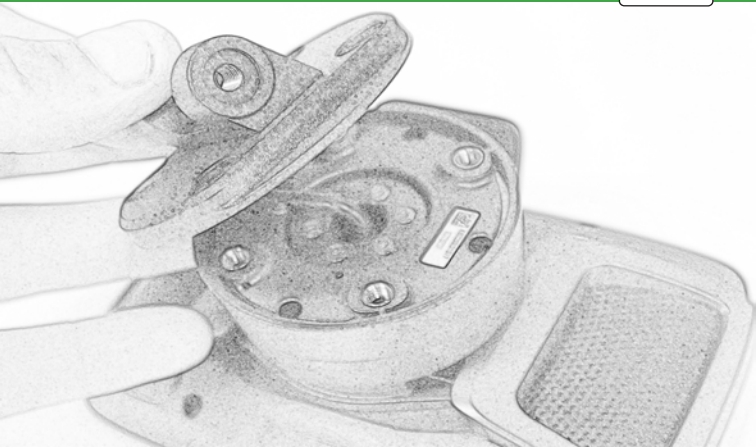

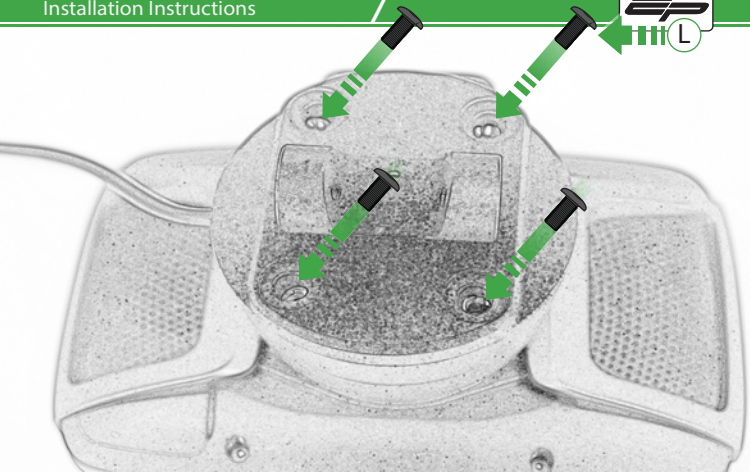

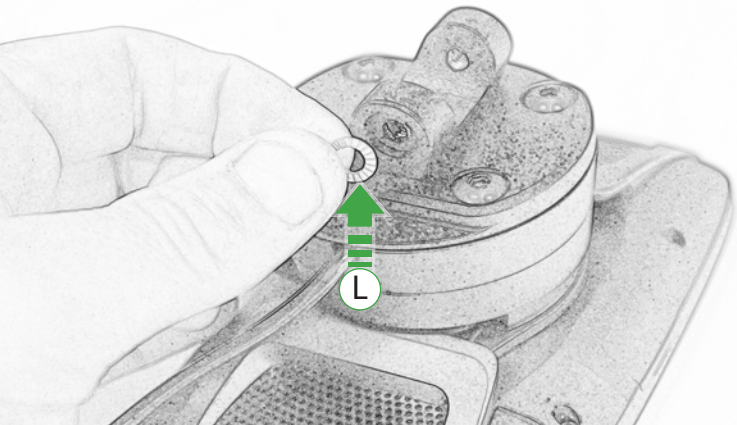

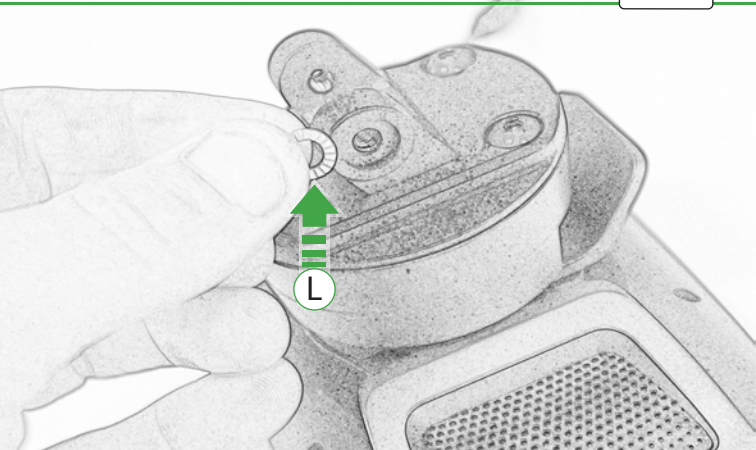

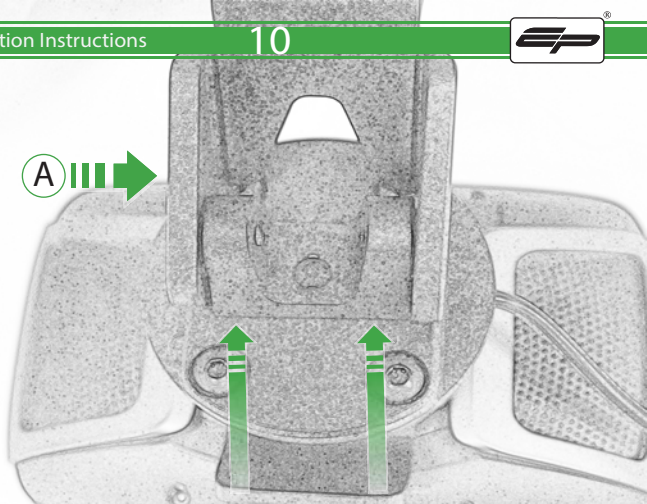

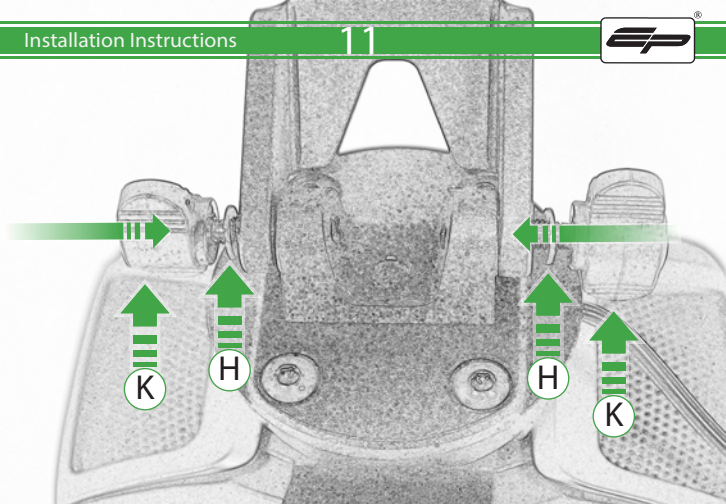

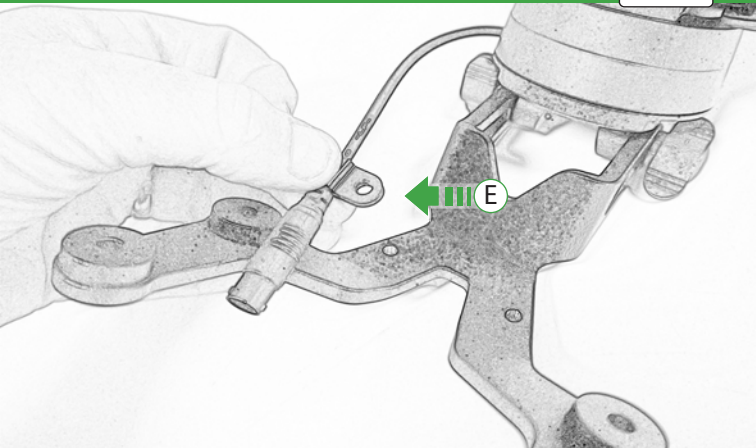

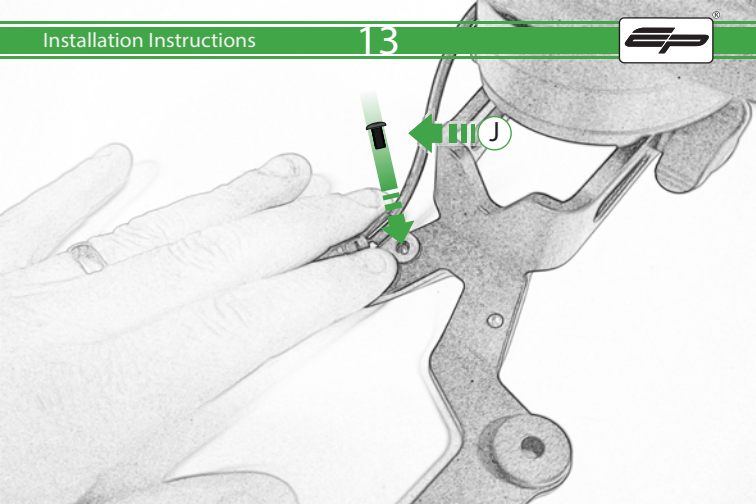



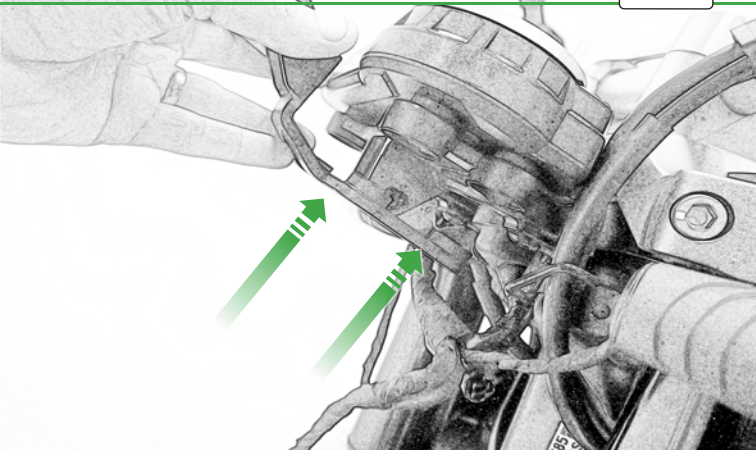



OEM PART

M

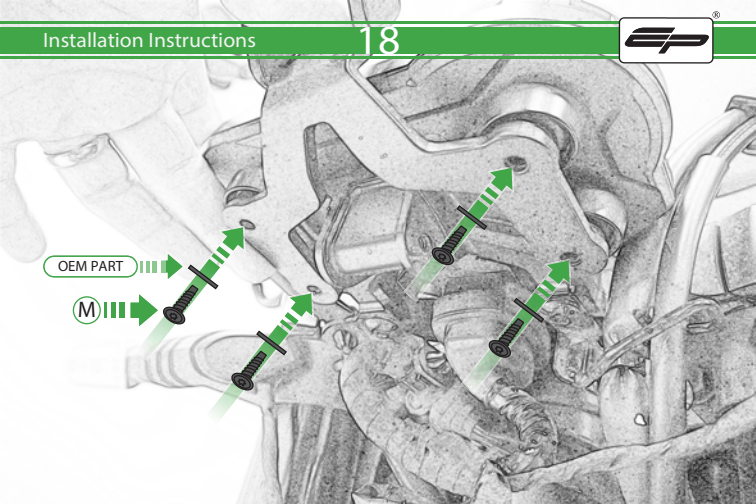





 **ESSENTIAL CHECKS** 

It is recommended that periodic inspections are made to ensure that all bolts are tightened to the specified torque settings.

Should the bike be involved in an accident a thorough inspection should be made and any components that have taken an impact, no matter how small, be replaced