



EVOTECH[®]
P E R F O R M A N C E

BMW S1000R

Crash protection

Installation Instructions



Kit Contents PRN013782

- | | |
|------------------------------------|-----------------------------|
| Ⓐ 1 x L/H Bracket | Ⓘ 1 x Main Shaft |
| Ⓑ 1 x R/H Inner Bracket | Ⓙ 2 x M10 x 60 Caphead Bolt |
| Ⓒ 1 x R/H Outer Bracket | Ⓚ 2 x M12 Washers |
| Ⓓ 1 x L/H Bobbin Spacer | Ⓛ 2 x Polyurathane Washer |
| Ⓔ 1 x R/H Bobbin Spacer | Ⓜ 2 x Bobbin Heads |
| Ⓕ 1 x Concial Spacer | Ⓝ 2 x M8 x 25 Caphead Bolt |
| Ⓖ 1 x M12 x 60 x 1.25 Caphead Bolt | |
| Ⓗ 1 x M12 x 85 x 1.25 Caphead Bolt | |

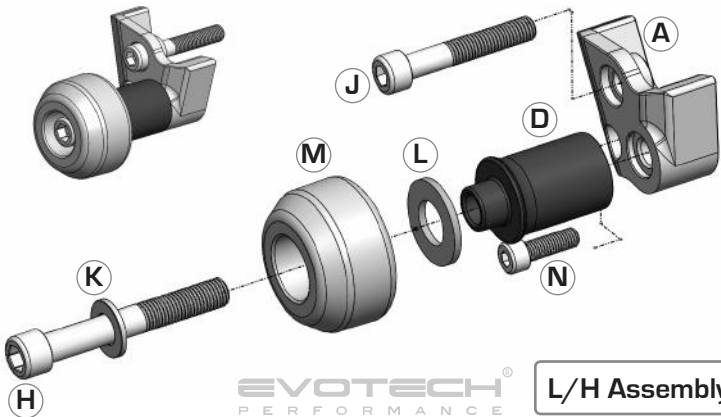

EVOTECH[®]
P E R F O R M A N C E

L/H Assembly

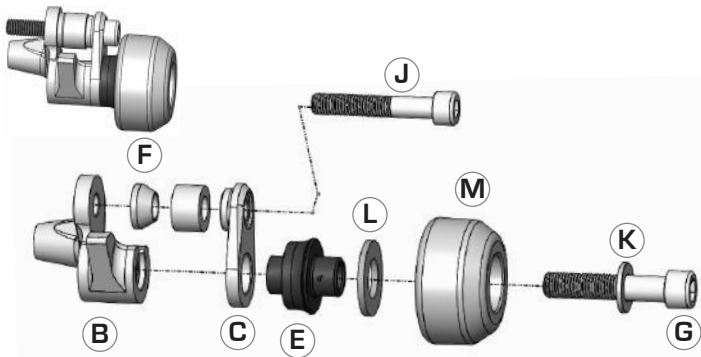

EVOTECH[®]
P E R F O R M A N C E

R/H Assembly

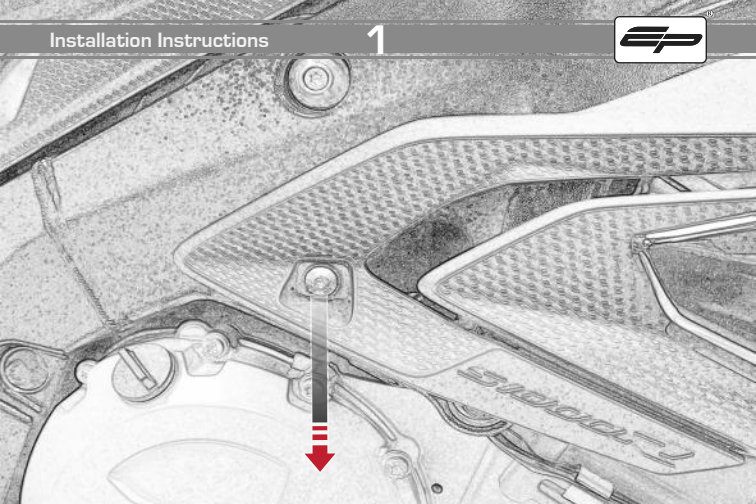

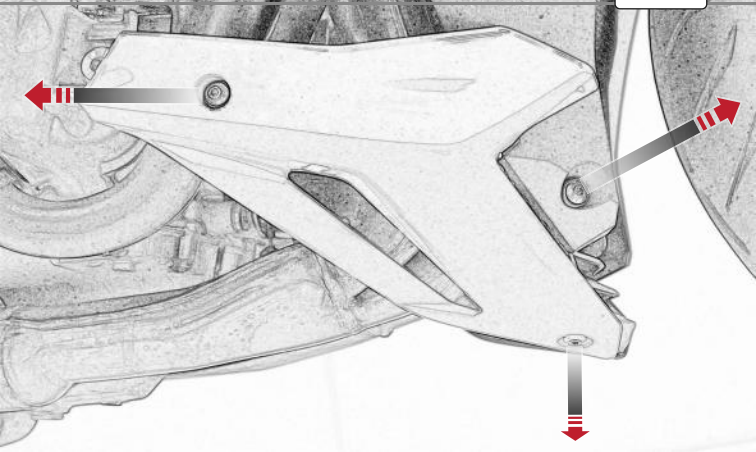

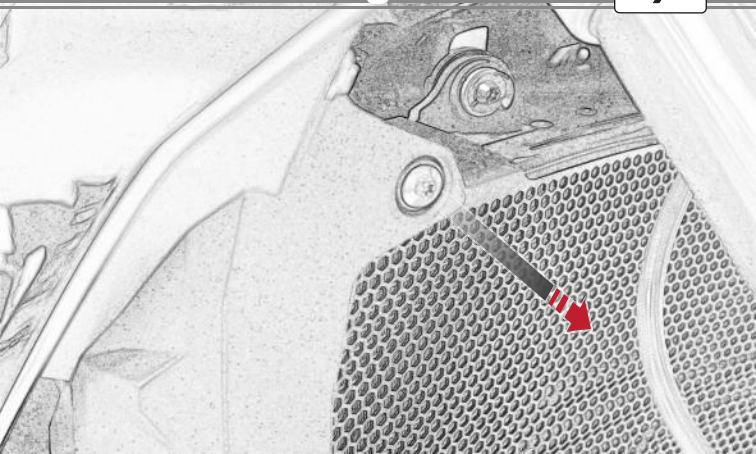

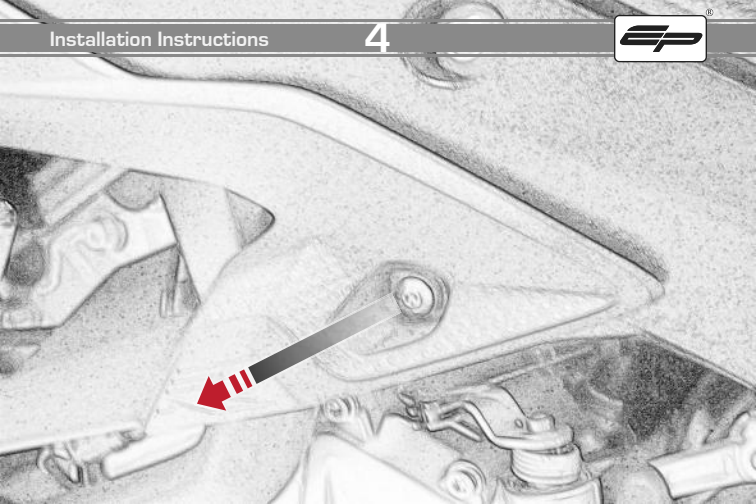

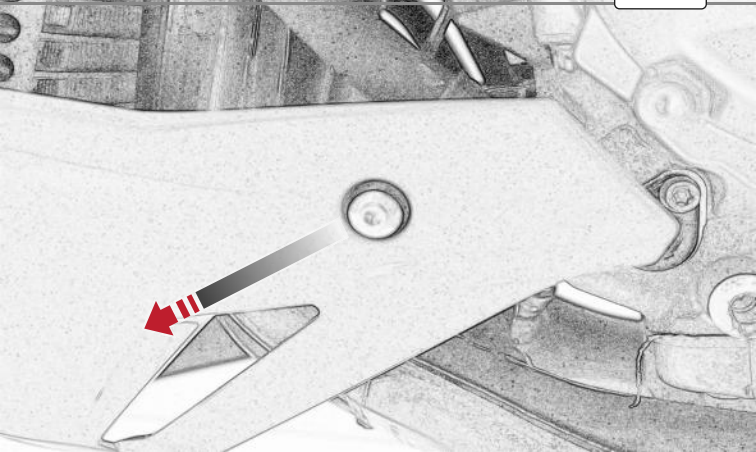

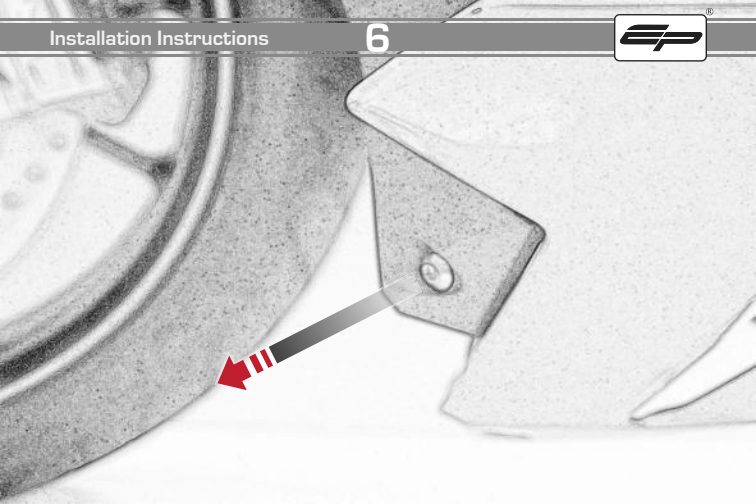

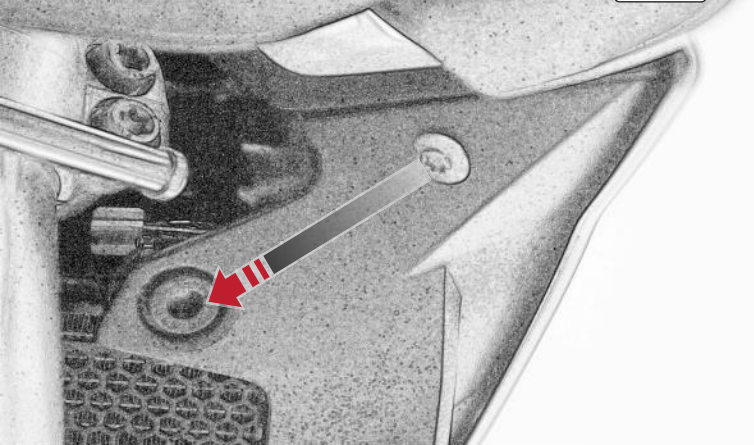

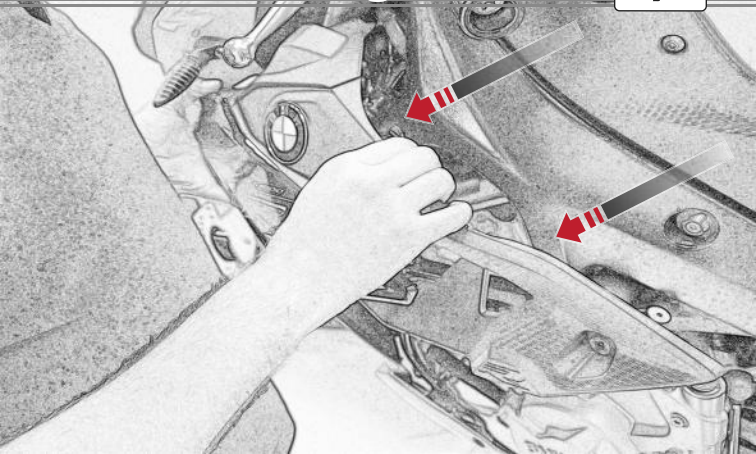

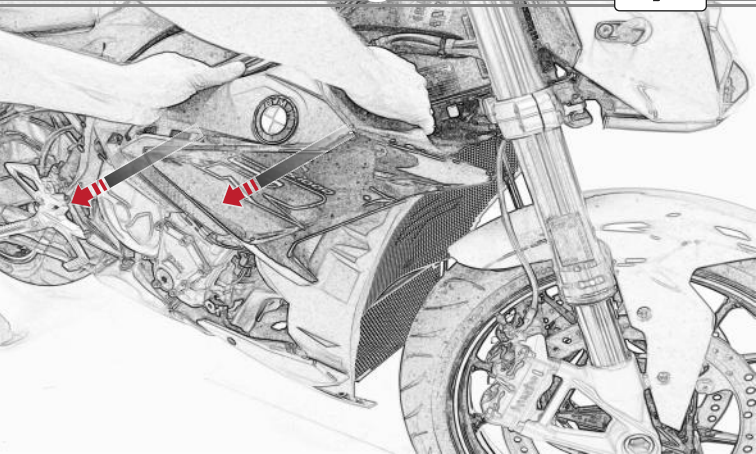

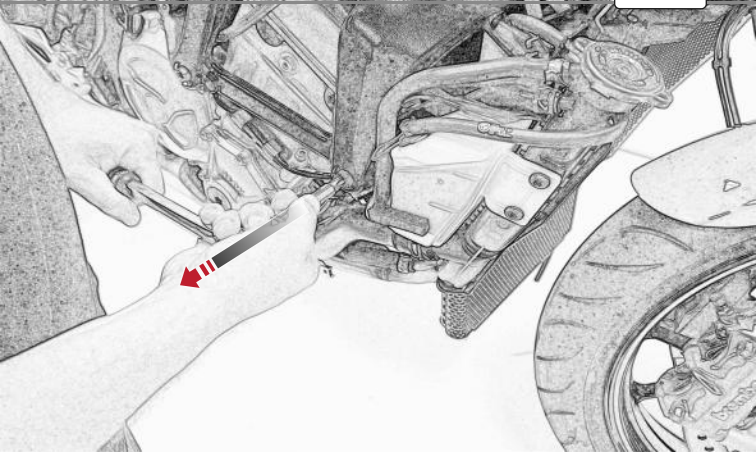

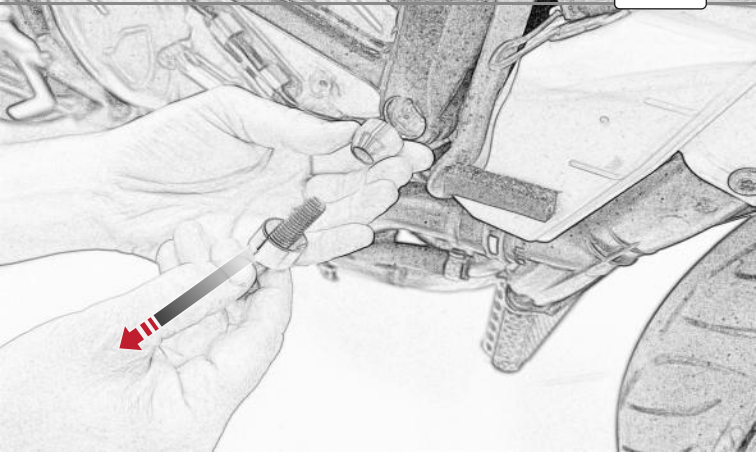

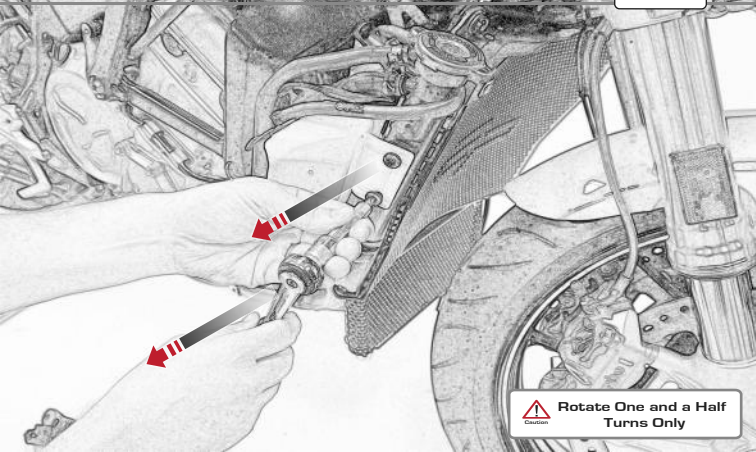

**Rotate One and a Half
Turns Only**

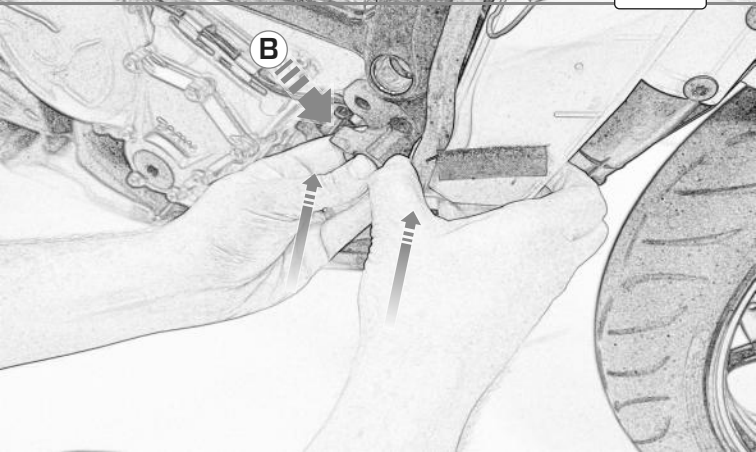

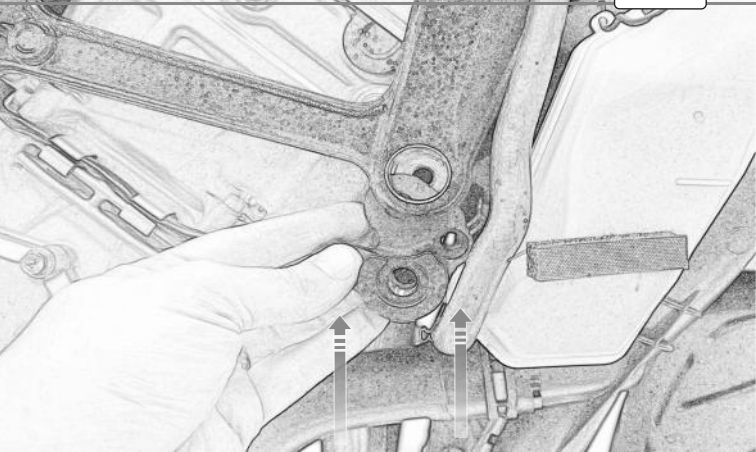

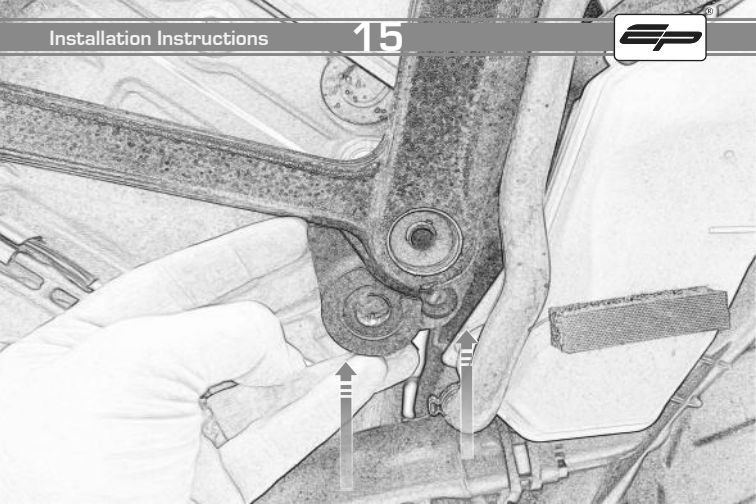

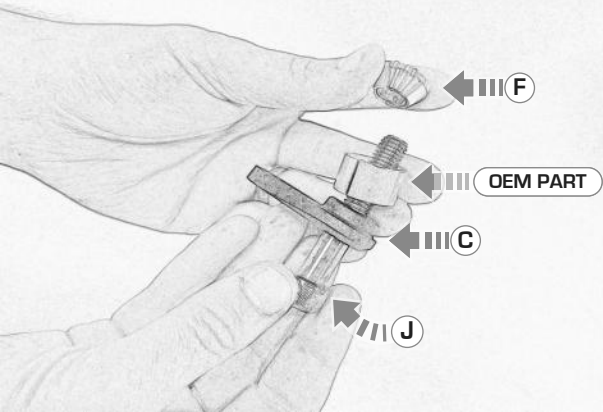





Do Not Fully Tighten

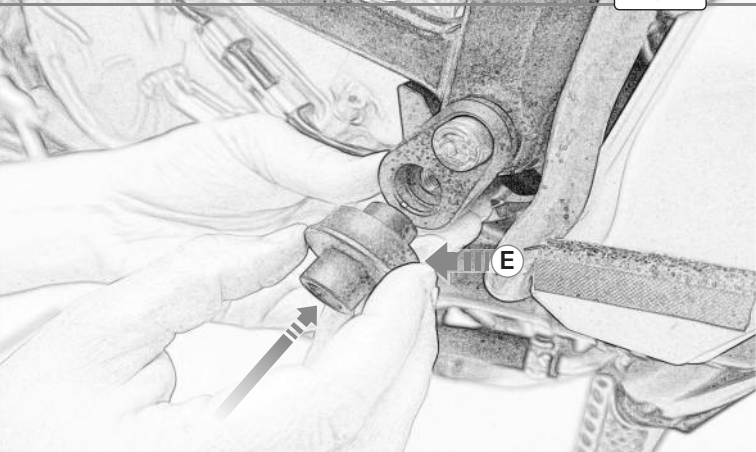

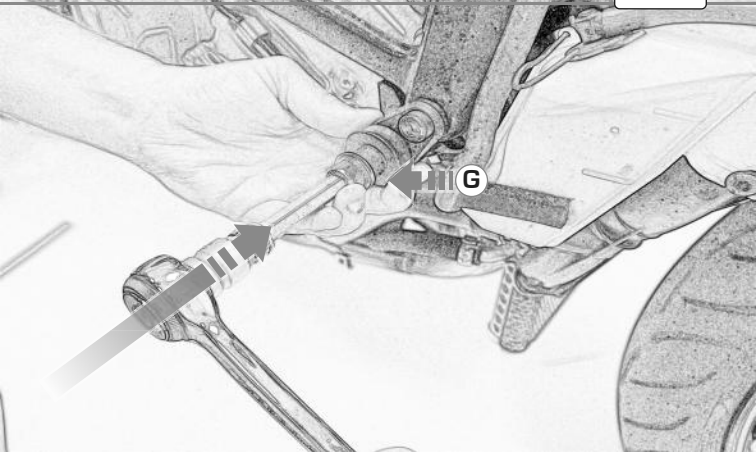

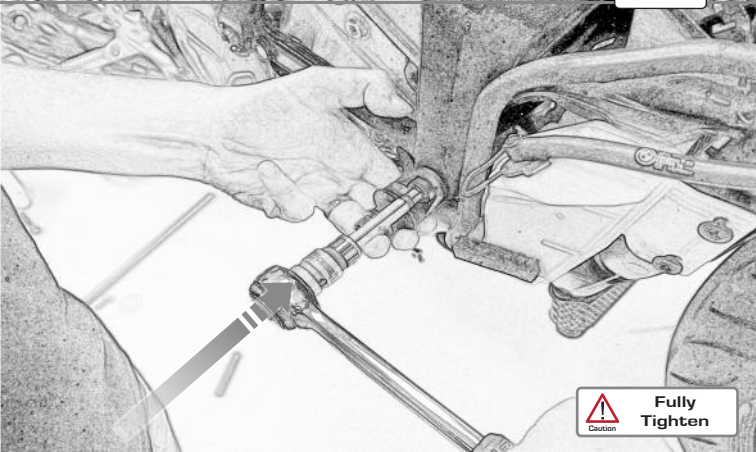

 **Fully Tighten**
Caution

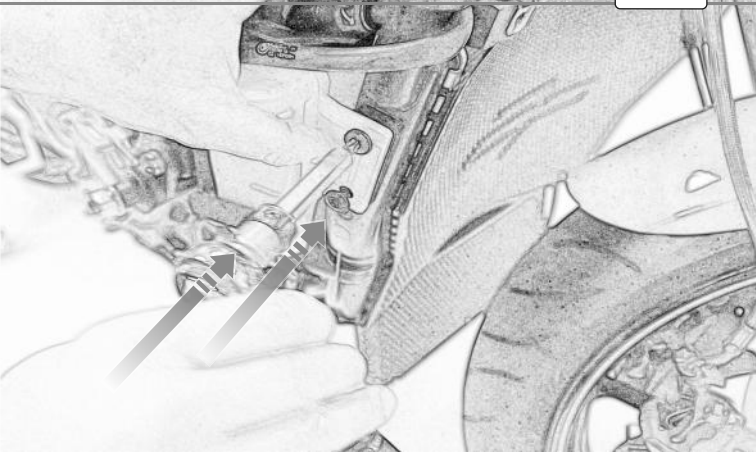

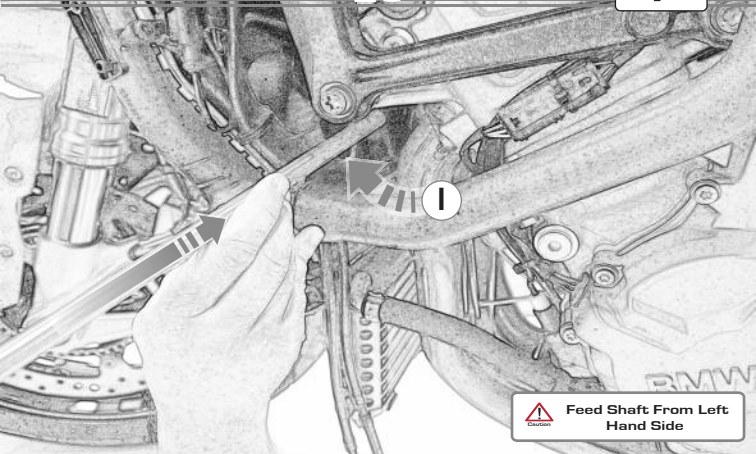

 **Feed Shaft From Left Hand Side**



Caution

**Locate Shaft in
Right Hand Bracket**

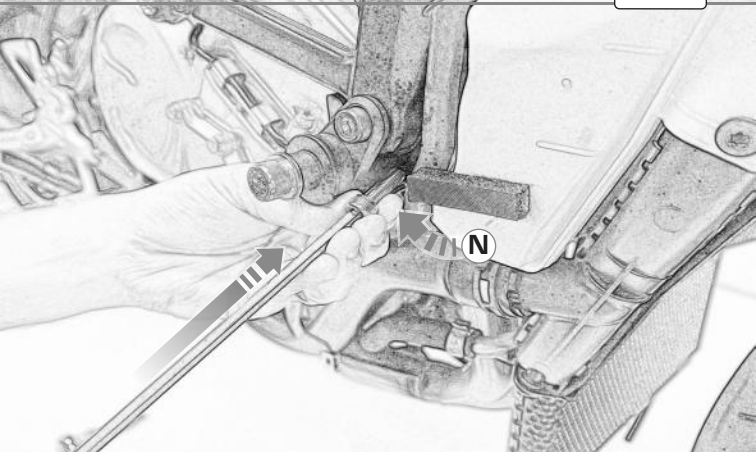

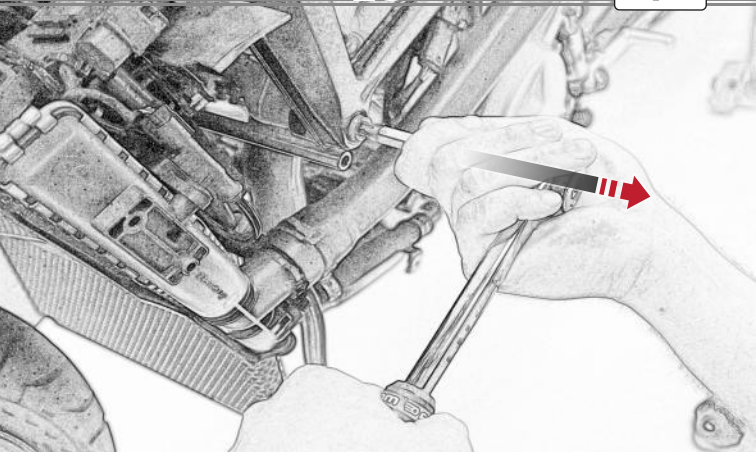

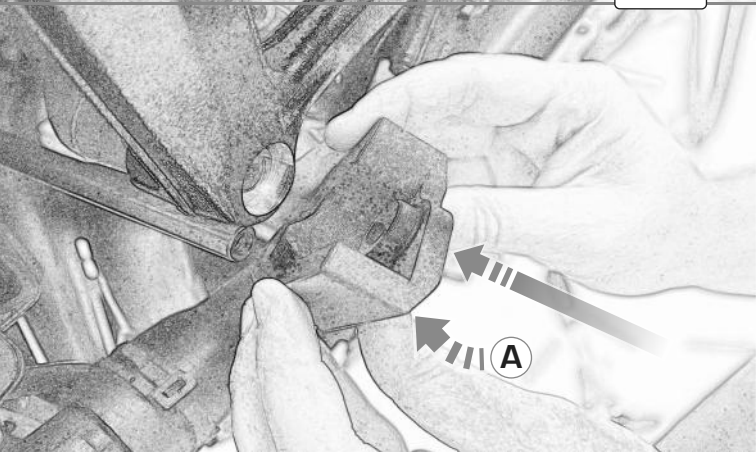

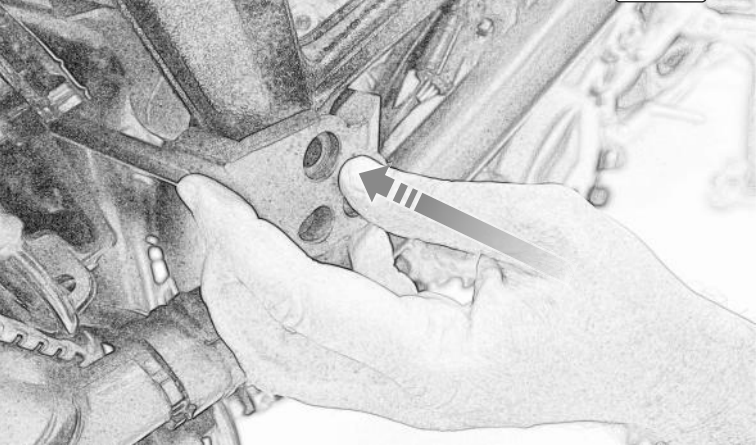

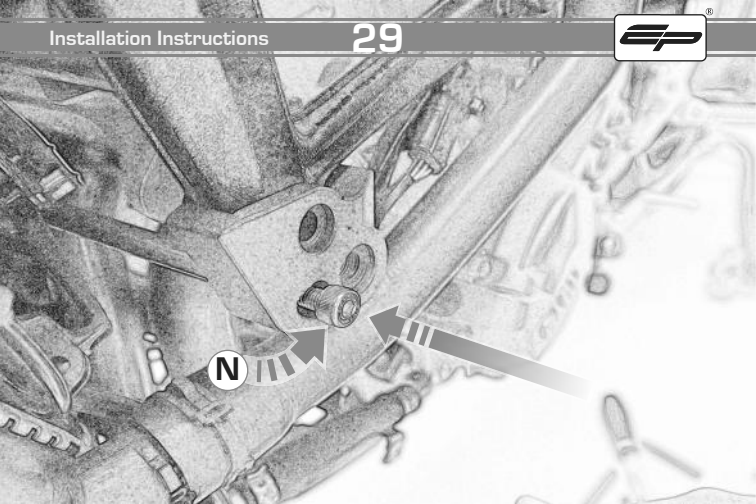

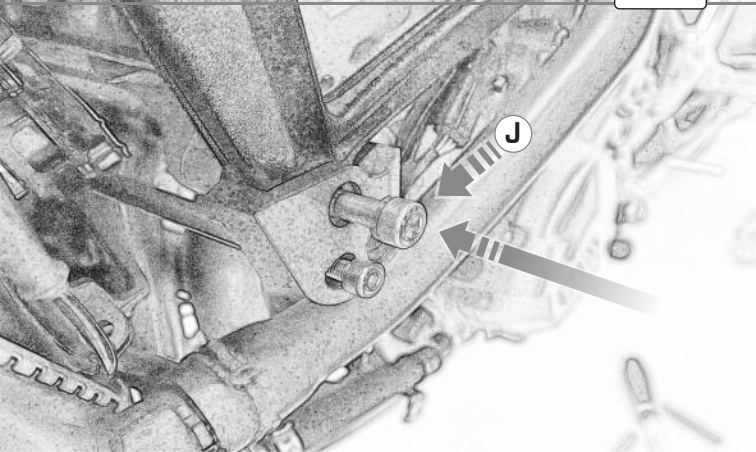

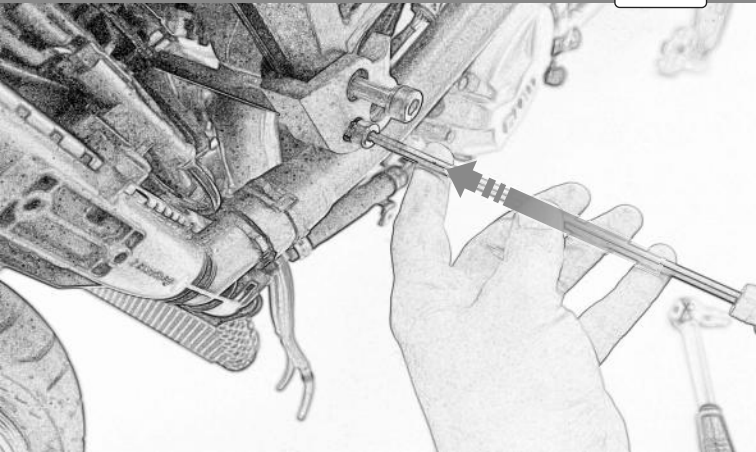

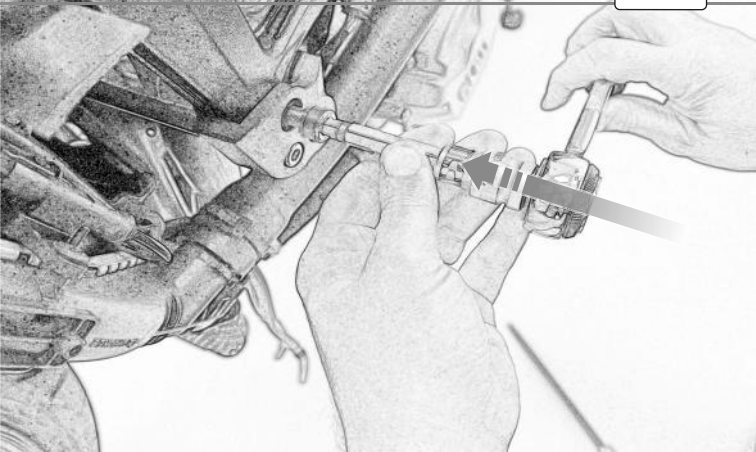

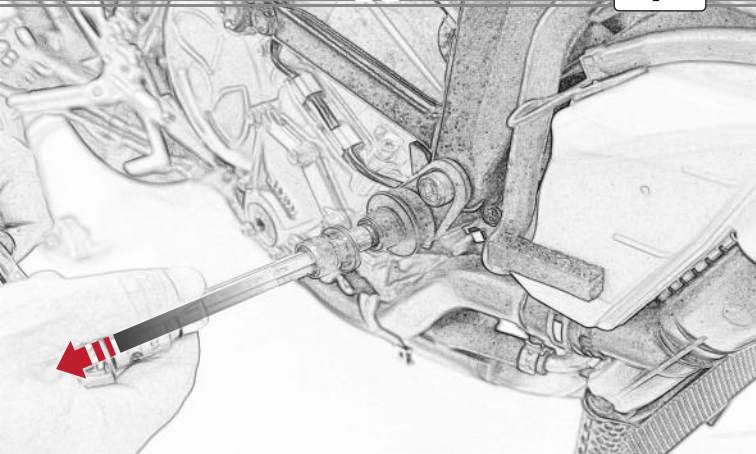

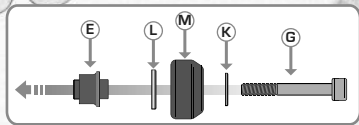
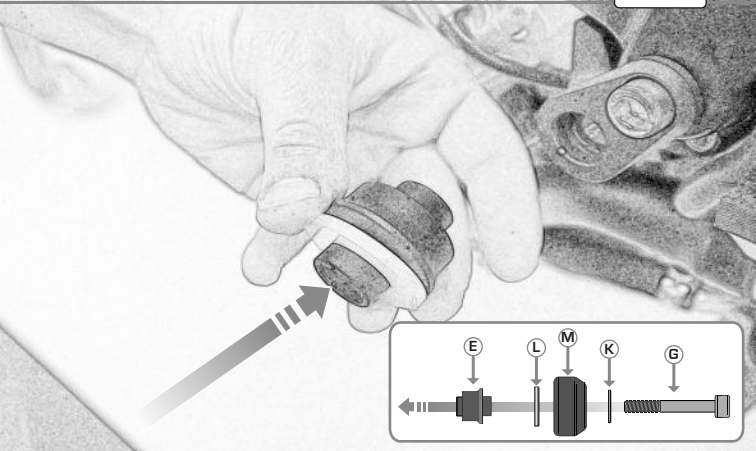



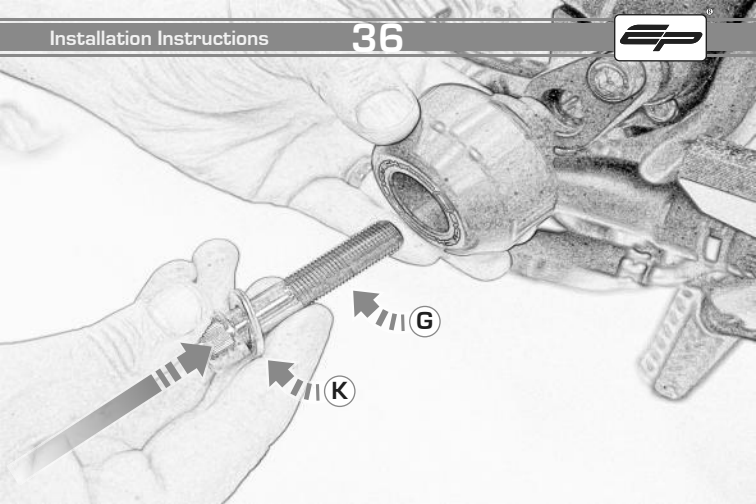

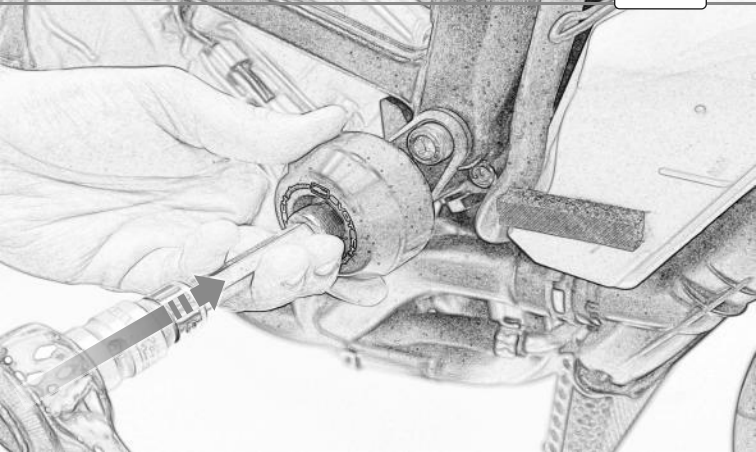

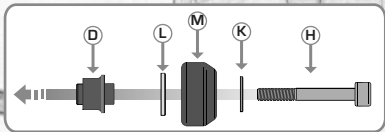
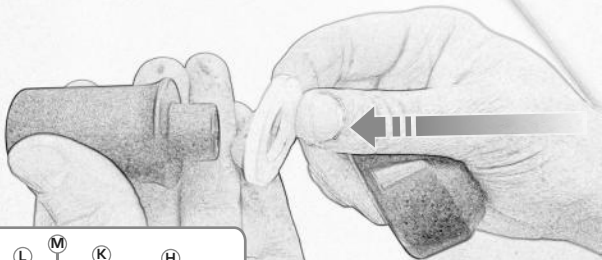

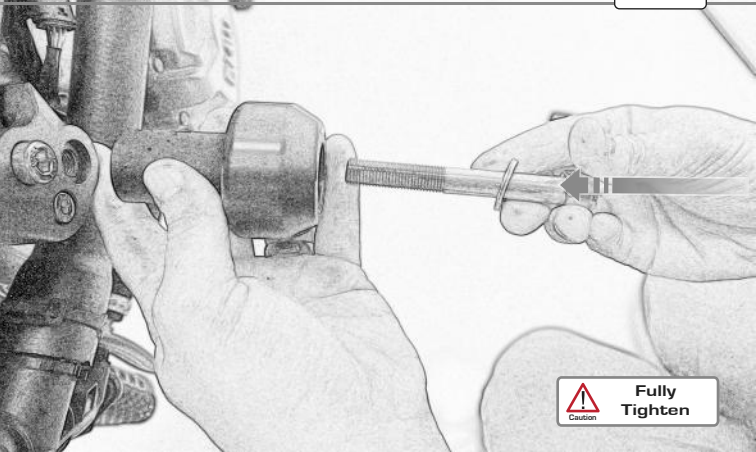

Caution

Fully Tighten



Reverse Stages

9 - 1



ESSENTIAL CHECKS



It is recommended that periodic inspections are made to ensure that all bolts are tightened to the specified torque settings.

Should the bike be involved in an accident a thorough inspection should be made and any components that have taken an impact, no matter how small, be replaced



EVOTECH®
P E R F O R M A N C E

www.evotech-performance.com